

CICS Transaction Server for z/OS



# Customization Guide

*Version 3 Release 2*



CICS Transaction Server for z/OS



# Customization Guide

*Version 3 Release 2*

**Note!**

Before using this information and the product it supports, be sure to read the general information under "Notices" on page 923.

This edition applies to Version 3 Release 2 of CICS Transaction Server for z/OS, program number 5655-M15, and to all subsequent versions, releases, and modifications until otherwise indicated in new editions.

© Copyright IBM Corporation 1977, 2011.

US Government Users Restricted Rights – Use, duplication or disclosure restricted by GSA ADP Schedule Contract with IBM Corp.

---

# Contents

<b>Preface</b> . . . . .	xvii
What this book is about . . . . .	xvii
Who this book is for. . . . .	xvii
What you need to know to understand this book . . . . .	xvii
How to use this book . . . . .	xvii
Notes on terminology . . . . .	xvii
Syntax notation and conventions used in this book . . . . .	xviii
<b>Summary of changes</b> . . . . .	xix
Changes for CICS Transaction Server for z/OS, Version 3 Release 2. . . . .	xix
Changes for CICS Transaction Server for z/OS, Version 3 Release 1. . . . .	xix
Changes for CICS Transaction Server for z/OS, Version 2 Release 3 . . . . .	xx

---

## Part 1. Customizing with user exit programs . . . . . 1

<b>Chapter 1. Global user exit programs</b> . . . . .	3
Writing global user exit programs . . . . .	3
Register conventions . . . . .	3
31-bit addressing implications . . . . .	4
Using CICS services . . . . .	4
Using channels and containers . . . . .	5
Assembler programs and LEASM . . . . .	6
EDF and global user exits . . . . .	6
The global work area . . . . .	6
Making trace entries . . . . .	6
Parameters passed to the global user exit program . . . . .	7
Returning values to CICS . . . . .	10
Restrictions on the use of fields as programming interfaces . . . . .	11
Exit programs and the CICS storage protection facility . . . . .	11
Errors in user exit programs . . . . .	12
Defining, enabling, and disabling an exit program . . . . .	12
Viewing active global user exits . . . . .	13
Invoking more than one exit program at a single exit . . . . .	13
Invoking a single exit program at more than one exit . . . . .	14
Making programs threadsafe . . . . .	14
Sample global user exit programs . . . . .	15
Basic sample and example programs . . . . .	15
Sample programs for specific exits . . . . .	18
Alphabetical list of global user exit points . . . . .	25
Global user exit points by functional area . . . . .	32
Activity keypoint program exit XAKUSER . . . . .	32
Application Associated Data exit, XAPADMGR, in the AP domain . . . . .	33
Basic Mapping Support exits XBMIN and XBMOU . . . . .	34
Bridge facility exit XFAINTU . . . . .	38
Data tables management exits XDTRD, XDTAD, and XDTLC . . . . .	40
DBCTL interface control program exit XXDFA . . . . .	45
DBCTL tracking program exits XXDFB and XXDTO . . . . .	46
Dispatcher domain exits XDSBWT and XDSAWT . . . . .	47
DL/I interface program exits XDLIPRE and XDLIPOST . . . . .	48
Dump domain exits XDUREQ, XDUREQC, XDUCLSE, and XDUOUT. . . . .	53
Enqueue EXEC interface program exits XNQEREQ and XNQEREQC. . . . .	60
EXEC interface program exits XEIIIN, XEIIOUT, XEISPIN, and XEISPOUT . . . . .	67
File control domain exits, XFCFRIN and XFCFROUT. . . . .	72

File control EXEC interface API exits XFCREQ and XFCREQC . . . . .	85
File control EXEC interface SPI exits XFCAREQ and XFCAREQC . . . . .	98
File control file state program exits XFCSREQ and XFCSREQC . . . . .	111
File control open/close program exit XFCNREC . . . . .	121
File control quiesce receive exit, XFCVSDS . . . . .	122
File control quiesce send exit XFCQUIS . . . . .	124
File control recovery program exits XFCBFAIL, XFCBOUT, XFCBOVER, and XFCLDEL . . . . .	126
Front End Programming Interface exits XSZARQ and XSZBRQ . . . . .	137
Good morning message program exit XGMTEXT . . . . .	138
HTTP client open and send exits: XWBAUTH, XWBOPEN and XWBSNDO . . . . .	138
Intersystem communication program exits XISCONA and XISLCLQ . . . . .	138
Interval control program exits XICREQ, XICEXP, and XICTENF . . . . .	143
Interval control EXEC interface program exits XICEREQ, XICERES, and XICEREQC . . . . .	145
Loader domain exits XLDLOAD and XLDELETE . . . . .	162
Log manager domain exit XLGSTRM . . . . .	164
Message domain exit XMEOUT . . . . .	168
Monitoring domain exit XMNOUT. . . . .	172
Pipeline domain exits . . . . .	174
Program control program exits XPCREQ, XPCERES, XPCREQC, XPCFTCH, XPCHAIR, XPCTA, and XPCABND. . . . .	175
Resource manager interface program exits XRMIIN and XRMIOUT . . . . .	193
Resource management install and discard exit XRSINDI . . . . .	195
Signon and signoff exits XSNON, XSNOFF, and XSNEX . . . . .	199
Statistics domain exit XSTOUT . . . . .	202
System recovery program exit XSRAB. . . . .	203
System termination program exit XSTERM . . . . .	206
Temporary storage domain exits XTSQRIN, XTSQROUT, XTSPTIN, and XTSPTOUT. . . . .	207
Temporary storage EXEC interface program exits XTSEREQ and XTSEREQC . . . . .	212
Terminal allocation program exit XALCAID . . . . .	221
Terminal control program exits XTCIN, XTCOUT, and XTCATT . . . . .	223
'Terminal not known' condition exits XALTENF and XICTENF . . . . .	224
Transaction manager domain exit XXMATT . . . . .	232
Transient data program exits XTDREQ, XTDIN, and XTDOUT . . . . .	234
Transient data EXEC interface program exits XTDEREQ and XTDEREQC . . . . .	236
User log record recovery program exits XRCINIT and XRCINPT . . . . .	244
VTAM terminal management program exit XZCATT . . . . .	247
VTAM working-set module exits XZCIN, XZCOUT, XZCOUT1, and XZIQUE . . . . .	248
XISQUE exit for managing IPIC intersystem queues. . . . .	258
XRF request-processing program exit XXRSTAT . . . . .	263
<b>Chapter 2. Task-related user exit programs . . . . .</b>	<b>267</b>
Introduction to the task-related user exit mechanism (the adapter) . . . . .	267
The stub program . . . . .	269
Returning control to the application program . . . . .	270
Task-related user exits and EDF . . . . .	270
Writing a task-related user exit program . . . . .	271
Obligations of OPENAPI task-related user exits . . . . .	271
User exit parameter lists . . . . .	273
The schedule flag word . . . . .	287
Register handling in the task-related user exit program. . . . .	288
Addressing-mode implications . . . . .	289
Exit programs and the CICS storage protection facility . . . . .	290

Recursion within a task-related user exit program . . . . .	290
Purging tasks . . . . .	290
Using CICS services in your task-related user exit program . . . . .	291
Using channels and containers . . . . .	292
Assembler programs and LEASM . . . . .	292
Wait states in your task-related user exit program . . . . .	292
Work areas . . . . .	292
Coding a program to be invoked by the CICS SPI . . . . .	293
Coding a program to be invoked by the CICS syncpoint manager . . . . .	293
Coding a program to be invoked by the CICS task manager . . . . .	297
Coding a program to be invoked at CICS termination . . . . .	298
Using EDF with your task-related user exit program . . . . .	301
Administering the adapter . . . . .	302
What you must do before using the adapter . . . . .	303
Tracing a task-related user exit program . . . . .	304
<b>Chapter 3. The user exit programming interface (XPI) . . . . .</b>	<b>305</b>
Overview of the XPI . . . . .	305
Making an XPI call . . . . .	308
Setting up the XPI environment . . . . .	312
XPI register usage . . . . .	312
The XPI copy books . . . . .	313
Reentrancy considerations resulting from XPI calls . . . . .	313
Global user exit XPI examples, showing the use of storage . . . . .	313
An example showing how to build a parameter list incrementally . . . . .	318
XPI syntax . . . . .	319
Directory domain XPI functions . . . . .	321
The BIND_LDAP call . . . . .	321
The END_BROWSE_RESULTS call . . . . .	323
The FLUSH_LDAP_CACHE call . . . . .	323
The FREE_SEARCH_RESULTS call . . . . .	324
The GET_ATTRIBUTE_VALUE call . . . . .	325
The GET_NEXT_ATTRIBUTE call . . . . .	326
The GET_NEXT_ENTRY call . . . . .	327
The SEARCH_LDAP call . . . . .	328
The START_BROWSE_RESULTS call . . . . .	329
The UNBIND_LDAP call . . . . .	330
Dispatcher XPI functions . . . . .	331
Synchronization protocols for SUSPEND and RESUME processing . . . . .	331
The ADD_SUSPEND call . . . . .	334
The SUSPEND call . . . . .	335
The RESUME call . . . . .	339
The DELETE_SUSPEND call . . . . .	340
The WAIT_MVS call . . . . .	340
The CHANGE_PRIORITY call . . . . .	344
Dump control XPI functions . . . . .	345
The SYSTEM_DUMP call . . . . .	345
The TRANSACTION_DUMP call . . . . .	347
Enqueue domain XPI functions . . . . .	349
The ENQUEUE function . . . . .	349
The DEQUEUE function . . . . .	350
Kernel domain XPI functions . . . . .	351
The START_PURGE_PROTECTION function . . . . .	351
The STOP_PURGE_PROTECTION function . . . . .	351
Nesting purge protection calls . . . . .	352
Loader XPI functions . . . . .	352

The DEFINE_PROGRAM call . . . . .	353
The ACQUIRE_PROGRAM call . . . . .	356
The RELEASE_PROGRAM call . . . . .	358
The DELETE_PROGRAM call . . . . .	359
Log manager XPI functions . . . . .	360
The INQUIRE_PARAMETERS call . . . . .	360
The SET_PARAMETERS call . . . . .	361
Monitoring XPI functions . . . . .	361
The MONITOR call . . . . .	362
The INQUIRE_MONITORING_DATA call . . . . .	364
Program management XPI functions . . . . .	366
The INQUIRE_PROGRAM call . . . . .	366
The INQUIRE_CURRENT_PROGRAM call . . . . .	373
The SET_PROGRAM call . . . . .	375
The START_BROWSE_PROGRAM call . . . . .	379
The GET_NEXT_PROGRAM call . . . . .	380
The END_BROWSE_PROGRAM call . . . . .	381
The INQUIRE_AUTOINSTALL call . . . . .	382
The SET_AUTOINSTALL call . . . . .	382
State data access XPI functions . . . . .	384
The INQ_APPLICATION_DATA call . . . . .	384
The INQUIRE_SYSTEM call . . . . .	386
The SET_SYSTEM call . . . . .	391
Storage control XPI functions . . . . .	392
The GETMAIN call . . . . .	392
The FREEMAIN call . . . . .	395
The INQUIRE_ACCESS call . . . . .	395
The INQUIRE_ELEMENT_LENGTH call . . . . .	396
The INQUIRE_SHORT_ON_STORAGE call . . . . .	397
The INQUIRE_TASK_STORAGE call . . . . .	398
The SWITCH_SUBSPACE call . . . . .	399
Trace control XPI function . . . . .	399
The TRACE_PUT call . . . . .	400
Transaction management XPI functions . . . . .	401
The INQUIRE_CONTEXT call . . . . .	401
The INQUIRE_DTRTRAN call . . . . .	403
The INQUIRE_MXT call . . . . .	403
The INQUIRE_TCLASS call . . . . .	405
The INQUIRE_TRANDEF call . . . . .	406
The INQUIRE_TRANSACTION call . . . . .	414
The SET_TRANSACTION call . . . . .	418
User journaling XPI function . . . . .	419
The WRITE_JOURNAL_DATA call . . . . .	419

---

**Part 2. Customizing with initialization and shutdown programs . . . . . 423**

<b>Chapter 4. Writing initialization and shutdown programs. . . . .</b>	<b>425</b>
Writing initialization programs . . . . .	425
First-phase PLT programs . . . . .	425
Second phase PLT programs . . . . .	426
Effect of delayed recovery on PLTPI processing . . . . .	427
Writing shutdown programs . . . . .	428
First phase PLT programs . . . . .	428
PLT programs for the second quiesce stage. . . . .	428
The shutdown assist utility program, DFHCESD . . . . .	429
General considerations when writing initialization and shutdown programs . . . . .	429



Storage keys for PLT programs . . . . .	430
---	-----

---

**Part 3. Customizing with user-replaceable programs . . . . . 433**

<b>Chapter 5. General notes about user-replaceable programs . . . . .</b>	<b>435</b>
Rewriting user-replaceable programs . . . . .	435
Assembling and link-editing user-replaceable programs . . . . .	436
User-replaceable programs and the storage protection facility . . . . .	437
Execution key for user-replaceable programs . . . . .	437
Data storage key for user-replaceable programs . . . . .	438
<b>Chapter 6. Writing a program error program . . . . .</b>	<b>439</b>
The sample program error programs . . . . .	443
<b>Chapter 7. Writing a transaction restart program . . . . .</b>	<b>445</b>
The DFHREST communications area . . . . .	446
The CICS-supplied transaction restart program . . . . .	447
<b>Chapter 8. Writing a terminal error program . . . . .</b>	<b>449</b>
Background to error handling for sequential devices . . . . .	449
When an abnormal condition occurs . . . . .	449
Terminal control program . . . . .	450
Terminal abnormal condition program . . . . .	450
Terminal error program . . . . .	450
The communication area . . . . .	451
Terminal abnormal condition line entry (TACLE) . . . . .	451
The sample terminal error program . . . . .	451
Components of the sample terminal error program . . . . .	451
Structure of the sample terminal error program . . . . .	453
Sample terminal error program messages . . . . .	456
Generating the sample terminal error program . . . . .	458
Writing your own terminal error program . . . . .	470
Why write your own terminal error program? . . . . .	470
Restrictions on the use of EXEC CICS commands . . . . .	470
Addressing the contents of the communication area . . . . .	471
Addressing the contents of the TACLE . . . . .	473
Example of a user-written terminal error program . . . . .	475
<b>Chapter 9. Writing a node error program . . . . .</b>	<b>479</b>
Background to CICS-VTAM error handling . . . . .	480
Why use a NEP to supplement CICS default actions? . . . . .	480
An overview of writing a NEP . . . . .	481
The default NEP . . . . .	482
The sample NEP . . . . .	482
Multiple NEPs . . . . .	485
When an abnormal condition occurs . . . . .	486
The communication area . . . . .	487
The sample node error program . . . . .	496
Compatibility with the sample terminal error program . . . . .	496
Components of the sample node error program . . . . .	496
Generating the sample node error program . . . . .	499
Writing your own node error program . . . . .	505
Restrictions on the use of EXEC CICS commands . . . . .	505
Entry and addressability . . . . .	506
Coding for the 3270 'unavailable printer' condition . . . . .	506
Coding for session failures . . . . .	507

Coding for specific VTAM sense codes . . . . .	508
Writing multiple NEPs . . . . .	508
DFHZNEPI macros . . . . .	508
Handling shutdown hung terminals in the node error program . . . . .	510
Using the node error program with XRF or persistent sessions . . . . .	510
The node error program in an XRF environment . . . . .	510
The node error program with persistent session support . . . . .	511
Changing the recovery notification . . . . .	511
Changing the recovery message . . . . .	512
Changing the recovery transaction . . . . .	512
Using the node error program with VTAM generic resources. . . . .	512
<b>Chapter 10. Writing a program to control autoinstall of terminals . . . . .</b>	<b>515</b>
Autoinstalling terminals—preliminary considerations . . . . .	515
Coding entries in the VTAM LOGON mode table . . . . .	516
Using model terminal support (MTS) . . . . .	516
The autoinstall control program for terminals . . . . .	517
The autoinstall control program at INSTALL . . . . .	517
The communication area at INSTALL for terminals . . . . .	518
How CICS builds the list of autoinstall models . . . . .	519
Returning information to CICS . . . . .	520
CICS action on return from the control program . . . . .	523
The autoinstall control program at DELETE . . . . .	525
The communication area at DELETE for terminals . . . . .	525
Naming, testing, and debugging your autoinstall control program . . . . .	526
Finding the name of an autoinstall control program . . . . .	526
Testing and debugging . . . . .	526
The sample autoinstall control programs for terminals . . . . .	527
Customizing the sample program. . . . .	528
<b>Chapter 11. Writing a program to control autoinstall of consoles . . . . .</b>	<b>535</b>
Autoinstalling consoles—preliminary considerations . . . . .	535
Leaving it all to CICS . . . . .	535
Using an autoinstall control program . . . . .	535
The autoinstall control program at INSTALL . . . . .	536
The communication area at INSTALL for consoles . . . . .	536
How CICS builds the list of autoinstall models . . . . .	538
Returning information to CICS . . . . .	538
CICS action on return from the control program . . . . .	540
The autoinstall control program at DELETE . . . . .	540
The sample autoinstall control programs for consoles . . . . .	541
<b>Chapter 12. Writing a program to control autoinstall of APPC connections . . . . .</b>	<b>543</b>
Autoinstalling APPC connections—preliminary considerations . . . . .	543
Local APPC single-session connections initiated by CINIT . . . . .	543
Local APPC parallel-session and single-session connections initiated by BIND . . . . .	543
Autoinstall templates for APPC connections . . . . .	544
Benefits of autoinstall . . . . .	544
Requirements for autoinstall . . . . .	544
The autoinstall control program for APPC connections . . . . .	545
Recovery and restart . . . . .	545
The autoinstall control program at INSTALL . . . . .	545
The communication area at INSTALL for APPC connections. . . . .	545
The autoinstall control program at DELETE . . . . .	549
When autoinstalled APPC connections are deleted . . . . .	549

The sample autoinstall control program for APPC connections . . . . .	550
Default actions of the sample program . . . . .	550
Resource definitions . . . . .	551
<b>Chapter 13. Writing a program to control autoinstall of IPIC connections</b>	<b>553</b>
Autoinstalling IPIC connections: preliminary considerations . . . . .	553
The autoinstall user program at INSTALL . . . . .	555
The autoinstall user program at DELETE . . . . .	556
When autoinstalled IPCONN are deleted . . . . .	557
The sample autoinstall user program for IPIC connections (IPCONN) . . . . .	557
Default actions of the sample program . . . . .	558
Resource definitions . . . . .	558
<b>Chapter 14. Writing a program to control autoinstall of shipped terminals</b>	<b>559</b>
Installing shipped terminals and connections . . . . .	559
CICS-generated aliases . . . . .	560
Resetting the terminal identifier . . . . .	560
The autoinstall control program at INSTALL . . . . .	561
The communications area at INSTALL for shipped terminals . . . . .	562
The autoinstall control program at DELETE . . . . .	564
Default actions of the sample programs . . . . .	565
<b>Chapter 15. Writing a program to control autoinstall of virtual terminals</b>	<b>567</b>
How Client virtual terminals are autoinstalled . . . . .	567
Autoinstall models . . . . .	567
Terminal identifiers . . . . .	567
Why override TERMIDs? . . . . .	568
How bridge facility virtual terminals are autoinstalled . . . . .	570
Using the terminal autoinstall control program for bridge facilities . . . . .	570
Bridge facility name uniqueness . . . . .	571
The autoinstall control program at INSTALL . . . . .	571
The communications area at INSTALL for Client virtual terminals . . . . .	571
The communications area at INSTALL for bridge facility virtual terminals . . . . .	573
The autoinstall control program at DELETE . . . . .	575
The communications area at DELETE for Client virtual terminals . . . . .	575
The communications area at DELETE for bridge facility virtual terminals . . . . .	576
Default actions of the sample programs . . . . .	577
<b>Chapter 16. Writing a program to control autoinstall of programs</b> . . . . .	<b>579</b>
Autoinstalling programs—preliminary considerations . . . . .	579
Autoinstall model definitions . . . . .	580
Autoinstalling programs invoked by EXEC CICS LINK commands . . . . .	580
Autoinstall processing of mapsets . . . . .	581
System autoinstall . . . . .	581
Benefits of autoinstalling programs . . . . .	581
Reduced system administration costs . . . . .	581
Saving in virtual storage . . . . .	581
Faster startup times . . . . .	582
Requirements for program autoinstall . . . . .	582
The autoinstall control program at INSTALL . . . . .	583
The sample autoinstall control program for programs, DFHPGADX . . . . .	586
Customizing the sample program . . . . .	586
Resource definition . . . . .	587
Testing and debugging your program . . . . .	588
<b>Chapter 17. Writing a dynamic routing program</b> . . . . .	<b>589</b>

Routing transactions dynamically . . . . .	590
Dynamic transactions . . . . .	590
When the dynamic routing program is invoked . . . . .	590
Information passed to the dynamic routing program . . . . .	591
Changing the target CICS region . . . . .	592
Changing the program name . . . . .	593
Telling CICS whether to route or terminate a transaction . . . . .	593
If the system is unavailable or unknown . . . . .	594
Invoking the dynamic routing program at end of routed transactions . . . . .	594
Invoking the dynamic routing program on abend . . . . .	594
Modifying the initial terminal data . . . . .	595
Modifying the application's communications area . . . . .	595
Receiving information from a routed transaction . . . . .	596
Some processing considerations . . . . .	596
Unit of work considerations . . . . .	597
Routing DPL requests dynamically . . . . .	597
When the dynamic routing program is invoked . . . . .	598
Changing the target CICS region . . . . .	599
Changing the program name . . . . .	599
Changing the transaction ID . . . . .	600
Telling CICS whether to route or terminate a DPL request . . . . .	600
If an error occurs in route selection . . . . .	600
Using the XPCERES exit to check the availability of resources on the target region . . . . .	601
Invoking the dynamic routing program at end of routed requests . . . . .	602
Modifying the application's input communications area . . . . .	602
Monitoring the application's output communications area . . . . .	602
Some processing considerations . . . . .	602
Unit of work considerations . . . . .	603
Routing bridge requests dynamically . . . . .	603
Changing bridge request parameters . . . . .	604
Rejecting a Link3270 bridge request . . . . .	605
Handling route selection errors of Link3270 bridge requests . . . . .	605
Using the XPCERES exit to check the availability of resources on the target region . . . . .	605
Re-invoking the dynamic routing program after Link3270 bridge requests . . . . .	606
Link3270 bridge dynamic routing considerations . . . . .	606
Modifying the application's containers . . . . .	607
Routing by user ID . . . . .	607
Parameters passed to the dynamic routing program . . . . .	607
Naming your dynamic routing program . . . . .	621
Testing your dynamic routing program . . . . .	621
Dynamic transaction routing sample programs . . . . .	622
<b>Chapter 18. Writing a distributed routing program . . . . .</b>	<b>623</b>
Differences between the distributed and dynamic routing interfaces . . . . .	624
Routing BTS activities . . . . .	625
Which BTS activities can be dynamically routed? . . . . .	625
When the distributed routing program is invoked . . . . .	626
Changing the target CICS region . . . . .	627
Telling CICS whether to route the activity . . . . .	627
If an error occurs in route selection . . . . .	628
Invoking the distributed routing program on the target region . . . . .	628
Routing method requests for enterprise beans and CORBA stateless objects . . . . .	629
Where workload balancing occurs . . . . .	629
Which requests can be dynamically routed? . . . . .	631

When the distributed routing program is invoked . . . . .	632
Changing the target CICS region . . . . .	633
Telling CICS whether to route the method request . . . . .	634
If an error occurs in route selection . . . . .	634
Invoking the distributed routing program on the target region . . . . .	634
Dealing with a disabled CorbaServer . . . . .	635
Performing a rolling upgrade of an EJB/CORBA server. . . . .	637
Routing non-terminal-related START requests . . . . .	637
Which requests can be dynamically routed?. . . . .	637
When the distributed routing program is invoked . . . . .	638
Changing the target CICS region . . . . .	639
Telling CICS whether to route the request . . . . .	639
If an error occurs in route selection . . . . .	640
Using the XICERES exit to check the availability of resources on the target region . . . . .	640
Invoking the distributed routing program on the target region . . . . .	641
Routing inbound Web service requests . . . . .	641
Which requests can be dynamically routed?. . . . .	641
When the distributed routing program is invoked . . . . .	642
Changing the target CICS region . . . . .	643
Telling CICS whether to route the request . . . . .	643
If an error occurs in route selection . . . . .	644
Invoking the distributed routing program on the target region . . . . .	644
Routing by user ID . . . . .	644
Dealing with an abend on the target region . . . . .	644
Some processing considerations . . . . .	645
Parameters passed to the distributed routing program . . . . .	645
Naming your distributed routing program . . . . .	656
Distributed transaction routing sample programs . . . . .	657
<b>Chapter 19. Writing a CICS–DBCTL interface status program . . . . .</b>	<b>659</b>
The sample CICS–DBCTL interface status program . . . . .	660
<b>Chapter 20. Writing a 3270 bridge exit program . . . . .</b>	<b>661</b>
<b>Chapter 21. Writing a security exit program for IIOF . . . . .</b>	<b>663</b>
The sample programs . . . . .	665
DFHXOPUS . . . . .	665
DFHEBURM . . . . .	666
<b>Chapter 22. Writing programs to customize JVMs . . . . .</b>	<b>667</b>
Writing Java classes to redirect JVM stdout and stderr output . . . . .	667
The com.ibm.cics.server.OutputRedirectionPlugin interface . . . . .	668
Possible destinations for output . . . . .	669
Handling output redirection errors and internal errors . . . . .	669
Using DFHJVMRO to modify the Language Environment enclave for a JVM . . . . .	670
Using DFHJVMAT to modify options in a JVM profile . . . . .	671
Options in the JVM profile that are available to DFHJVMAT . . . . .	672
<b>Chapter 23. Writing a distinguished name program for clients of enterprise beans . . . . .</b>	<b>675</b>
Sample programs and copy books . . . . .	677
<b>Chapter 24. Writing an EJB event program . . . . .</b>	<b>679</b>
Overview of the EJB event program. . . . .	679
The DFHEJEP communications area . . . . .	680

Event codes . . . . .	681
The EJB event sample program . . . . .	682
Actions of the default program . . . . .	682
Writing your own EJB event program . . . . .	682
<b>Chapter 25. Writing programs to customize Language Environment</b>	
<b>run-time options for XPLink programs . . . . .</b>	<b>685</b>
DFHAPXPO . . . . .	685
Defining run-time options. . . . .	685

---

## **Part 4. Customizing the XRF overseer program. . . . . 687**

<b>Chapter 26. The extended recovery facility overseer program . . . . .</b>	<b>689</b>
The sample XRF overseer program . . . . .	689
The functions of the sample program . . . . .	689
How the sample overseer program interfaces with CICS . . . . .	693
How to tell the overseer which actives and alternates to monitor . . . . .	693
The DFHWOSM macros . . . . .	695
The DFHWOSM tokens . . . . .	695
DFHWOSM FUNC=BUILD macro . . . . .	696
DFHWOSM FUNC=CLOSE macro . . . . .	696
DFHWOSM FUNC=DSECT macro . . . . .	697
DFHWOSM FUNC=JJC macro . . . . .	697
DFHWOSM FUNC={JJSIQJJS} macro . . . . .	697
DFHWOSM FUNC=OPEN macro . . . . .	698
DFHWOSM FUNC=OSCMD macro . . . . .	699
DFHWOSM FUNC=READ macro. . . . .	699
DFHWOSM FUNC=TERM macro . . . . .	703
Customizing the sample XRF overseer program . . . . .	703
Loop or wait detection. . . . .	705
Assembling and link-editing the overseer program . . . . .	705

---

## **Part 5. CICS journaling, monitoring, and statistics . . . . . 707**

<b>Chapter 27. CICS logging and journaling . . . . .</b>	<b>709</b>
The CICS log manager . . . . .	709
Log stream storage . . . . .	709
Enabling, disabling, and reading journals . . . . .	711
Enabling and disabling a journal . . . . .	711
Reading journal records offline . . . . .	712
Structure and content of CICS Transaction Server for z/OS format journal records . . . . .	712
Format of general log block header . . . . .	713
Format of general log journal record . . . . .	714
Start-of-run record . . . . .	716
Format of caller data . . . . .	716
Structure and content of COMPAT41-format journal records . . . . .	729
Format of COMPAT41 journal control label header . . . . .	729
Format of journal record . . . . .	731
Identifying records for the start of tasks and UOWs . . . . .	737
Format of journal records written to SMF . . . . .	737
The SMF block header . . . . .	738
The CICS product section . . . . .	740
The CICS data section . . . . .	742

<b>Chapter 28. CICS monitoring</b>	743
Introduction to CICS monitoring	743
How CICS monitoring data is passed to SMF	743
Coding additional event-monitoring points	744
Application naming event monitoring points	744
The monitoring control table (MCT)	747
CICS monitoring record formats	750
SMF header and SMF product section	750
CICS data section	754
<b>Chapter 29. Writing statistics collection and analysis programs</b>	769
Writing a program to collect CICS statistics	769
Background information	769
Resetting statistics counters	770
Using the EXEC CICS COLLECT and EXTRACT STATISTICS commands	770
CICS statistics record format	771
SMF header and SMF product section	771
CICS statistics data section	773
Using an XSTOUT global user exit program to filter statistics records	776
Processing the output from CICS statistics	777

---

## **Part 6. Customizing CICS compatibility interfaces** . . . . . 779

<b>Chapter 30. The dynamic allocation sample program</b>	781
Overview of the dynamic allocation program	781
Installing the program and transaction definitions	782
The dynamic allocation program—terminal operation	782
Using the dynamic allocation program’s Help feature	782
The dynamic allocation program—values	783
Abbreviation rules for keywords	784
System programming considerations	784
The flow of control when a DYNALLOC request is issued	784

---

## **Part 7. Customizing CICS security processing** . . . . . 787

<b>Chapter 31. Invoking an external security manager</b>	789
An overview of the CICS-ESM interface	789
The MVS router	789
The MVS router exit	789
Using ESM exit programs to access CICS-related information	791
For non-RACF users — the ESM parameter list	792
For RACF users — the RACF user exit parameter list	792
The installation data parameter list	793
CICS security control points	796
Using early verification processing	797
Writing an early verification routine	798
Using CICS API commands in an early verification routine	799
Return and reason codes from the early verification routine	799
<b>Chapter 32. Writing a “good night” program</b>	801
The communications area of the “good night” program	801
The sample “good night” program, DFH0GNIT	803
What the sample program does	803
Customizing the sample “good night” program	804

<b>Part 8. Examining and modifying resource attributes</b> . . . . .	<b>807</b>
<b>Chapter 33. Using the programmable interface to CEDA</b> . . . . .	<b>809</b>
When to use the programmable interface . . . . .	810
Using DFHEDAP in a DTP environment . . . . .	810
<b>Chapter 34. User programs for the system definition utility program (DFHCSDUP)</b> . . . . .	<b>813</b>
An overview of DFHCSDUP . . . . .	813
Invoking a user program from DFHCSDUP . . . . .	814
Writing a program to be invoked during EXTRACT processing . . . . .	814
The EXTRACT command . . . . .	814
When the user program is invoked . . . . .	815
Parameters passed from DFHCSDUP to the user program . . . . .	815
The sample EXTRACT programs . . . . .	816
Assembling and link-editing EXTRACT programs . . . . .	819
Invoking DFHCSDUP from a user program . . . . .	821
Entry parameters for DFHCSDUP . . . . .	822
Responsibilities of the user program . . . . .	824
The user exit points in DFHCSDUP . . . . .	824
Parameters passed to the user exit routines . . . . .	824
The initialization exit . . . . .	825
The get-command exit . . . . .	825
The extract exit . . . . .	826
The put-message exit . . . . .	827
The termination exit . . . . .	828
The sample program, DFH\$CUS1 . . . . .	829
<b>Part 9. Appendixes</b> . . . . .	<b>831</b>
<b>Appendix A. Coding entries in the VTAM LOGON mode table</b> . . . . .	<b>833</b>
Overview of the VTAM LOGON mode table . . . . .	833
TYPETERM device types and pointers to related LOGON mode data . . . . .	833
VTAM MODEENT macro operands . . . . .	835
PSERVIC screen size values for LUTYPEx devices . . . . .	840
Matching models and LOGON mode entries . . . . .	841
LOGON mode definitions for CICS-supplied autoinstall models . . . . .	850
<b>Appendix B. Default actions of the node abnormal condition program</b> . . . . .	<b>855</b>
DFHZNAC—default actions for terminal error codes . . . . .	855
CICS messages associated with VTAM errors . . . . .	861
DFHZNAC—default actions for system sense codes . . . . .	866
Action flag settings and meanings . . . . .	868
<b>Appendix C. Analyzing CICS restart information</b> . . . . .	<b>871</b>
<b>Appendix D. Using the transient data write-to-terminal program (DFH\$TDWT)</b> . . . . .	<b>873</b>
DFH\$TDWT—resource definitions required . . . . .	873
<b>Appendix E. Uppercase translation</b> . . . . .	<b>875</b>
Translating national characters to uppercase . . . . .	875
Using the XZCIN exit . . . . .	875
Using DFHTCTxx . . . . .	875
Translating TS data sharing messages to uppercase . . . . .	876



<b>Appendix F. The example program for the XTSEREQ global user exit, DFH\$XTSE . . . . .</b>	<b>877</b>
<b>Appendix G. Threadsafe XPI commands . . . . .</b>	<b>893</b>
<b>Bibliography . . . . .</b>	<b>895</b>
The CICS Transaction Server for z/OS library . . . . .	895
The entitlement set . . . . .	895
PDF-only books . . . . .	895
Other CICS books . . . . .	897
Books from related libraries . . . . .	897
MVS books . . . . .	897
VTAM books . . . . .	898
Other related books. . . . .	898
Determining if a publication is current . . . . .	898
<b>Accessibility . . . . .</b>	<b>901</b>
<b>Index . . . . .</b>	<b>903</b>
<b>Notices . . . . .</b>	<b>923</b>
<b>Trademarks . . . . .</b>	<b>925</b>



---

# Preface

---

## What this book is about

This book provides the information needed to extend and modify an IBM® CICS® Transaction Server for z/OS® system to match your requirements. It describes how you can tailor your system by coding exit programs, by replacing specific CICS-supplied default programs with versions that you write yourself, and by adapting sample programs.

---

## Who this book is for

This book is for those responsible for extending and enhancing a CICS system to meet the special processing needs of an installation.

---

## What you need to know to understand this book

To use this information, you must be familiar with some of the architecture of CICS and the programming interface to CICS. Programming interface information is described in the *CICS Application Programming Reference* and the *CICS System Programming Reference*.

Resource definition information is described in the *CICS Resource Definition Guide*.

To use the following information, you must be familiar with the IBM ACF/VTAM telecommunications access method:

- Chapter 9, “Writing a node error program,” on page 479
- Chapter 10, “Writing a program to control autoinstall of terminals,” on page 515
- Chapter 12, “Writing a program to control autoinstall of APPC connections,” on page 543

If your task involves error processing, you might have to consult *CICS Messages and Codes*, the *CICS Problem Determination Guide*, or the *CICS Diagnosis Reference*.

---

## How to use this book

The parts and chapters of the book are self-contained. Use an individual part or chapter as a guide when performing the task described in it.

---

## Notes on terminology

In this book, the term “CICS”, used without any qualification, refers to the CICS element of IBM CICS Transaction Server for z/OS. The term “VTAM” refers to ACF/VTAM. The term “APPC” (advanced program-to-program communication) refers to the LUTYPE6.2 intersystem connection (ISC) protocol.

The term “MVS” refers to those services and functions that are provided by the Base Control Program (BCP) of OS/390®. The BCP is a base element of OS/390.

CICS Transaction Server for z/OS, Version 3 Release 2 supports CICS applications written in:

- Assembler language

- C
- COBOL
- PL/I.

In this book, the phrase “the languages supported by CICS” refers to the above languages.

---

## Syntax notation and conventions used in this book

The symbols { }, [ ], and | are used in the syntax descriptions of the EXEC CICS commands and macros referred to in this book. They are not part of the command and you should not include them in your code. Their meanings are as follows:

- Braces { } enclose two or more alternatives, one of which you **must** code.
- Square brackets [ ] tell you that the enclosed is optional.
- The “or” symbol | separates alternatives.

In addition to these symbols, the following conventions apply:

- Punctuation symbols and uppercase characters should be coded exactly as shown.
- Lowercase characters indicate that user text should be coded as required.
- Default values are shown like this: DEFAULT.
- Options that are enclosed neither in braces { } nor in square brackets [ ] are mandatory.
- The ellipsis ... means that the immediately preceding option can be coded one or more times.
- All EXEC CICS commands require a delimiter appropriate to the language of the application. For a COBOL program this is ‘END-EXEC’, for example. Delimiters are not included in the syntax descriptions of the commands.

---

## Summary of changes

This book is based on the CICS Customization Guide for CICS Transaction Server for z/OS, Version 3 Release 1, SC34-6429-00. Changes from that edition are marked by vertical bars in the left margin.

---

### Changes for CICS Transaction Server for z/OS, Version 3 Release 2

For information about changes that have been made in CICS Transaction Server for z/OS, Version 3 Release 2, please refer to *What's New* in the information center, or the following publications:

- *CICS Transaction Server for z/OS Release Guide*
- *CICS Transaction Server for z/OS Migration from CICS TS Version 3.1*
- *CICS Transaction Server for z/OS Migration from CICS TS Version 2.3*
- *CICS Transaction Server for z/OS Migration from CICS TS Version 2.2*
- *CICS Transaction Server for z/OS Migration from CICS TS Version 1.3*

---

### Changes for CICS Transaction Server for z/OS, Version 3 Release 1

The more significant changes for this edition are:

- Because of the removal of support for Java hot-pooling, the following items have been removed:
  - Information about the user-replaceable programs DFHAPH8O and DFHJHPAT. DFHAPH8O was provided to allow you to alter the default Language Environment® run-time options for the Language Environment enclave where a Java program object was to be run. DFHJHPAT was optional and could be used for your own purposes; it was called before a Java program object was invoked.
  - The HOTPOOL attribute is removed from the DFHPGISX XPI calls INQUIRE PROGRAM and SET PROGRAM.
  - The TCB indicator UEPTH8 is no longer available in DFHUEPAR.
- Because of the removal of support for TCAM local terminals, the following information has been removed or rewritten:
  - The sections about the XTCTIN and XTCTOUT global user exits in the terminal control program (which were invoked on TCAM input and output events) have been removed.
  - “Using TCAM with CICS” (chapter 28 in the CICS TS 2.3 book) has been removed.
  - Chapter 8, “Writing a terminal error program,” on page 449 has been rewritten.
- There are minor changes to the parameters passed to the exit programs at the following global user exit points:
  - XICEREQC
  - XPCREQC
  - XTDEREQC
  - XTSEREQC
- Appendix G, “Threadsafe XPI commands,” on page 893 is a new section.

---

## Changes for CICS Transaction Server for z/OS, Version 2 Release 3

The more significant changes for this edition were:

- A new global user exit, XICERES, in the interval EXEC interface control program, was described in The XICERES global user exit and “Using the XICERES exit to check the availability of resources on the target region” on page 640.
- A new global user exit, XPCERES, in the program control program, was described in The XPCERES global user exit, “Using the XPCERES exit to check the availability of resources on the target region” on page 601, and “Using the XPCERES exit to check the availability of resources on the target region” on page 605.
- The XSSEX signon and signoff global user exit, introduced as a temporary migration aid in CICS TS 2.2, is to be retained in CICS TS 2.3. You can use XSSEX to make CICS handle EXEC CICS SIGNON and SIGNOFF commands in the same way as in CICS TS 1.3 and earlier—see “Exit XSSEX” on page 201.
- “Writing Java classes to redirect JVM stdout and stderr output” on page 667 is a new section.
- The following new sections were added to Chapter 18, “Writing a distributed routing program,” on page 623:
  - “Dealing with a disabled CorbaServer” on page 635
  - “Dealing with an abend on the target region” on page 644

---

## Part 1. Customizing with user exit programs





---

## Chapter 1. Global user exit programs

You can use the CICS *global user exit points*, in conjunction with programs of a special type that you write yourself (*global user exit programs*), to customize your CICS system.

A global user exit point, sometimes referred to as a *global user exit* is a place in a CICS module or domain at which CICS can transfer control to a global user exit program that you have written and at which CICS can resume control when your exit program has finished its work.

Each global user exit point has a unique identifier, and is located at a point in the module or domain at which it could be useful to do some extra processing. For example, at exit point XSTOUT in the statistics domain, an exit program can be given control before each statistics record is written to the SMF data set, and can access the relevant statistics record. You might want to use an exit program at this exit point to examine the statistics record and suppress the writing of unwanted records.

Global user exit support is provided automatically by CICS. However, there are several conventions that govern how you write your exit program, which are described in “Writing global user exit programs.” Because global user exit programs work as if they were part of the CICS module or domain, there are limits on the use you can make of CICS services. Most global user exit programs cannot use EXEC CICS commands, but can invoke some CICS services using the exit programming interface (XPI). For more information, see “Using CICS services” on page 4.

**Note:** Neither source nor object compatibility of CICS management modules is guaranteed from release to release. Any changes that affect exit programs are documented in the appropriate manual.

---

### Writing global user exit programs

A global user exit program must be written in assembler language and must be quasireentrant. However, if your user exit program calls the XPI, it must be fully reentrant. (For details about coding programs using XPI calls, refer to Chapter 3, “The user exit programming interface (XPI),” on page 305.)

**Remember:** A “reentrant” program is coded to allow one copy of itself to be used concurrently by several tasks; it does not modify itself while running. A “quasireentrant” program is serially reusable by different tasks. When it receives control it must be in the same state as when it relinquished control. Such a program can modify itself while running, and is therefore not fully reentrant.

### Register conventions

Register values are provided on entry to an exit program and only certain register values are guaranteed.

The register values that you can use on entry to an exit program are as follows:

- Register 1 contains the address of the user exit parameter list DFHUEPAR. Write-to-operator (WTO) commands use register 1. If your exit program uses WTO commands, you should save the address of DFHUEPAR first.

- Register 13 contains the address of the standard register save area where your exit program should store its own registers immediately after being invoked. This address is also in the field UEPEPSA in the parameter list pointed to by register 1.

If you want to issue operating system requests that use register 13 to point to a save area, you must switch register 13 to point to another save area. You must restore register 13 to its original contents before returning from your user exit program to the caller.

- Register 14 contains the return address to which the exit program should branch on completion of its work. You do this using the BR 14 instruction after restoring the calling module's registers, or using the RETURN macro.
- Register 15 contains the entry address of the exit program.

The exit program must save and restore any registers that it modifies, using the save area addressed by register 13.

## 31-bit addressing implications

- The global user exit is invoked in 31-bit AMODE.
- The global user exit may be either RMODE 24 or RMODE ANY.
- If you find it necessary to switch to 24-bit AMODE in the exit program, be sure to return correctly in 31-bit AMODE.
- Ensure the exit program is in 31-bit AMODE for XPI calls.
- Some of parameters passed in DFHUEPAR are addresses of storage above the 16MB line.

## Access register implications

- The global user exit is invoked in primary-space translation mode. For information about translation modes, see the *IBM ESA/370 Principles of Operation* manual.
- The contents of the access registers are unpredictable. For information about access registers, see the *IBM ESA/370 Principles of Operation* manual.
- If the global user exit modifies any access registers, it must restore them before returning control. CICS does **not** provide a save area for this purpose.
- The global user exit must return control in primary addressing mode.

## Using CICS services

The rules governing the use of CICS services in exit programs vary, depending on the exit point from which the exit program is being invoked.

The following general rules apply:

- No CICS services can be invoked from any exit point in the dispatcher domain.
- CICS services can be invoked using the exit programming interface (XPI) from most exits. If you use the XPI, note the rules and restrictions that are listed for each exit and each of the XPI macros. The XPI is described in Chapter 3, "The user exit programming interface (XPI)," on page 305.
- Some CICS services can be requested using EXEC CICS commands from some exits. The valid commands are listed in the detailed descriptions of the exits. If no commands are listed, it means that no EXEC CICS API or SPI commands are supported. EXEC CICS commands that cause an XCTL (either directly or implied); for example, **EXEC CICS XCTL** or **EXEC CICS SHUTDOWN** must never be used.

An exit program invoked at an exit that does not support the use of EXEC CICS commands must not call a task-related user exit program (TRUE). Calling a TRUE is equivalent to issuing an EXEC CICS command. Exceptions to this rule are programs invoked from the XFCFRIN and XFCFROUT exits, which may call a TRUE. TRUEs are described in Chapter 2, “Task-related user exit programs,” on page 267.

**Note:** In exits which support the use of EXEC CICS file control commands, file commands that form a related sequence (such as **EXEC CICS STARTBR**, **EXEC CICS READNEXT**, and **EXEC CICS ENDBR**) must all be issued in the same invocation of the exit program.

For example, if one invocation of an exit program issues an **EXEC CICS STARTBR** command, and the next invocation of the exit program for that same task issues an **EXEC CICS READNEXT** command, the READNEXT fails with an INVREQ condition.

- All exit programs that issue EXEC CICS commands must first address the EIB. This is not done automatically using the DFHEIENT macro, as is the case with normal EXEC assembler-language programs. Therefore, the first EXEC command to be issued from an exit program must be EXEC CICS ADDRESS EIB (eib-register), where “eib-register” is the default register (R11) or the register given as a parameter to the DFHEIENT macro.

All exit programs that issue EXEC CICS commands, and that use the DFHEIENT macro, should use the DFHEIRET macro to set a return code and return to CICS. See “Returning values to CICS” on page 10.

**Note:**

- If your global user exit program does not contain EXEC CICS commands, do not use the CICS command-level translator when assembling the program.
- Do not make non-CICS (for example, RACF® or MVS™) system service calls from global user exit programs.
- If an operating system request causes a wait, your whole CICS system will stop until the operating system request has been serviced.

### **Using EXEC CICS and XPI calls in the same exit program**

There are a number of exits where you can use both EXEC CICS commands and XPI calls, but you should ensure that there is no conflict in the usage of register 13. To avoid such conflict, use the DATAREG option on the DFHEIENT macro (see “XPI register usage” on page 312 for information).

For an example of how to use EXEC CICS commands and XPI calls in the same global user exit program, see Appendix F, “The example program for the XTSEREQ global user exit, DFH\$XTSE,” on page 877

## **Using channels and containers**

Global user exit programs can access channels and containers created by application programs. They can also create their own channels and pass them to programs which they call.

For information about channels and containers, see the *CICS Application Programming Guide*.

## Assembler programs and LEASM

Assembler programs translated with the LEASM option cannot be used as global user exit programs.

LEASM is used to produce Language Environment conforming main programs in assembler. For information about the LEASM translator option, see the *CICS Application Programming Guide*.

## EDF and global user exits

If you use the Execution Diagnostic Facility (EDF) to debug your applications, you must take care when compiling exit programs that issue EXEC CICS commands.

Normally, if an exit program issues EXEC CICS commands, these are displayed by EDF, if the latter is active. They appear between the “Start of Command” and “End of Command” screens for the command that caused the exit to be driven. If you want to suppress the display of EXEC CICS commands issued by your exit program, you must specify the NOEDF option when you translate the program. You should always specify NOEDF for programs in a production environment.

If an exit program that may be invoked during recovery processing issues EXEC CICS commands, you must translate it with the NOEDF option. Failure to do so may cause EDF toabend.

## The global work area

When you enable an exit program, you can ask CICS to provide a global work area for the exit program. An exit program can have its own global work area, or it can share a work area that is owned by another exit program.

The work area is associated with the exit program rather than with the exit point. For ease of problem determination, the global work area should be shared only by exit programs that are invoked from the same management module or domain. The address and length of the global work area are addressed by parameters **UEPGAA** and **UEPGAL** of the DFHUEPAR parameter list, which is described in “DFHUEPAR standard parameters” on page 7. If a user exit program does not own a global work area, UEPGAA is set to zero.

Application programs can communicate with user exit programs that use or share the same global work area. The application program uses the **EXEC CICS EXTRACT EXIT** command to obtain the address and length of the global work area.

A work area is freed only when all of the exit programs that use it are disabled. For examples of how to use a global work area, see the sample global user exit programs. They are listed in “Sample global user exit programs” on page 15.

## Making trace entries

If tracing is active, you can specify that an entry in the CICS trace table is made immediately before and immediately after the exit program runs.

- Use either of the following methods to create a trace entry before and after the exit program runs:
  - The UE option of the CETR transaction.
  - The UE option of the **EXEC CICS SET TRACETYPE** command.

- If your global user exit is in a domain, you can add extra trace calls to provide additional diagnostic information by setting the AP option of EXEC CICS SET TRACETYPE to level 1 or 2.
- Depending on which exit point you are using, you might be able to use the XPI DFHTRPTX TRACE\_PUT macro to create trace entries in the user exit program. This macro is described in Chapter 3, “The user exit programming interface (XPI),” on page 305. The individual descriptions of the global user exit points indicate whether you can use the XPI DFHTRPTX macro.

## Parameters passed to the global user exit program

The address of a parameter list is passed to the user exit program in register 1. The list contains some standard parameters that are passed to all global user exit programs, and might also contain some exit-specific parameters that are unique to the exit point from which the exit program is being invoked.

The exit-specific parameters are described with the individual exits in the section “Alphabetical list of global user exit points” on page 25. The standard parameter list is described in the following section.

You can map the parameter list using the DSECT DFHUEPAR, which is generated by the macro instruction

```
DFHUEXIT TYPE=EP, ID=exit_point_identifier
```

The ID parameter provides the extra data definitions that you need to map any exit-specific parameters. For example, the macro instruction

```
DFHUEXIT TYPE=EP, ID=XTDIN
```

generates the DSECT to map the standard parameters followed by the parameters that are specific to exit point XTDIN in the transient data program. If your exit program is to be invoked at more than one exit point, you can code up to 256 characters of relevant exit identifiers on a single DFHUEXIT macro instruction. For example:

```
DFHUEXIT TYPE=EP, ID=(XMNOUT, XSTOUT, XTDIN)
```

If your exit program is to be invoked at every global user exit point, you can code:

```
DFHUEXIT TYPE=EP, ID=ALL
```

If your user exit program is to be used both as a global user exit program and as a task-related user exit program, you must code both:

```
DFHUEXIT TYPE=EP, ID=exit_point_identifier
```

and:

```
DFHUEXIT TYPE=RM
```

(in this order) to generate the DSECTs appropriate to both types of user exit.

If a global user exit program needs to use the DFHRMCAL macro to invoke an external RMI, the DFHRMCAL macro instruction must follow the DFHUEXIT macro.

### DFHUEPAR standard parameters

```
DFHUEPAR DSECT
* STANDARD PARAMETERS
UEPEXN DS A ADDRESS OF EXIT NUMBER
UEPGAA DS A ADDRESS OF GLOBAL WORK AREA
```

*			(ZERO = NO WORK AREA)
UEPGAL	DS	A	ADDRESS OF GLOBAL WORK AREA LENGTH
UEPCRC	DS	A	ADDRESS OF CURRENT RETURN-CODE
UEPTCA	DS	A	RESERVED
UEPCSA	DS	A	RESERVED
UEPEPSA	DS	A	ADDRESS OF REGISTER SAVE AREA FOR USE BY EXIT PROGRAM
*			
UEPHMSA	DS	A	ADDRESS OF SAVE AREA USED FOR HOST MODULE'S REGISTERS
*			
UEPGIND	DS	A	ADDRESS OF CALLER'S TASK INDICATORS
UEPSTACK	DS	A	ADDRESS OF KERNEL STACK ENTRY
UEPXSTOR	DS	A	ADDRESS OF STORAGE FOR XPI PARAMETERS
UEPTRACE	DS	A	ADDRESS OF TRACE FLAG

### **UEPEXN**

points to a 1-byte binary field whose contents identify the global user exit point from which the exit program is being invoked. You need this information if your exit program can be invoked from more than one exit point.

DFHUEXIT TYPE=EP generates a list of equated values that relate the exit names (exitids) to the exit numbers used internally by CICS to identify the exits. You should always use the exitids, because the exit numbers may change in any future releases of CICS.

### **UEPGAA**

points to the global work area that was provided for the exit program when it was enabled. This is set to zero if no global work area is provided.

### **UEPGAL**

points to a halfword that contains the length of the global work area.

### **UEPCRC**

points to a halfword that is to contain the return code value from the exit program. When more than one program is called at a user exit, this field contains (on entry to the second and subsequent programs) the return code that was set by the previously invoked program.

For an example of how an exit program can set a different return code from that returned by a previous exit program at the same exit point, see the code snippet in "Invoking more than one exit program at a single exit" on page 13.

### **UEPTCA**

points to fetch-protect storage. Use of this field results in an abend ASRD at execution time.

### **UEPCSA**

points to fetch-protect storage. Use of this field results in an abend ASRD at execution time.

### **UEPEPSA**

points to a save area in which the exit program should store its own registers on entry. When the exit program is entered, register 13 is also pointing to this area. The convention is to save registers 14, 15, 0–12 at offset 12 (decimal) onward.

### **UEPHMSA**

points to the save area containing the registers of the calling module. Values for registers 14, 15, 0–13 are stored in this order from offset 12 (decimal) in this area.

Apart from register 15, which contains the return code value from the exit program, the values in this save area are used by CICS to reload the registers when returning to the calling CICS module. They should not be corrupted.

This address is **not** passed to global user exit programs invoked from exit points in CICS domains.

### UEPGIND

points to a 3-byte field containing indicators for use in AP domain user exits. For non-AP domain user exits, the indicators are always zero.

The first indicator byte can take one of two symbolic values, UEPGANY and UEPGCICS, which you can test to determine whether data locations can be above or below 16MB, and whether the application's storage is in CICS-key or user-key storage:

### UEPGANY

The application can accept addresses above 16MB. If the symbolic value is not UEPGANY, the application must be returned an address below 16MB.

### UEPGCICS

The application's working storage and the task's life-time storage are in CICS-key storage (TASKDATAKEY=CICS). If the symbolic value is not UEPGCICS, the application's working storage and the task's life-time storage are in user-key storage (TASKDATAKEY=USER).

The second and third bytes contain a value indicating the TCB mode of the global user exit program's caller. This is represented in DFHUEPAR as both a two-character code and a symbolic value, as follows:

Table 1. TCB indicators in DFHUEPAR. Description

Symbolic value	2-byte code	Description
UEPTQR	QR	The quasi-reentrant mode TCB
UEPTRO	RO	The resource-owning mode TCB
UEPTCO	CO	The concurrent mode TCB
UEPTSZ	SZ	The FEPI mode TCB
UEPTRP	RP	The ONC/RPC mode TCB
UEPTFO	FO	The file-owning mode TCB
UEPTSL	SL	The sockets listener mode TCB
UEPTSO	SO	The sockets mode TCB
UEPTS8	S8	The secure sockets layer mode TCB
UEPTD2	D2	The CICS-DB2 housekeeping mode TCB
UEPTJ8	J8	The J8 open TCB, used for JVMs that are in CICS key
UEPTJ9	J9	The J9 open TCB, used for JVMs that are in user key
UEPTJM	JM	The JM open TCB, used with the IBM SDK for z/OS, V1.4.2 for the master JVM that initializes the shared class cache
UEPTL8	L8	An L8 open TCB, used for OPENAPI TRUEs, or OPENAPI programs that are in CICS key
UEPTL9	L9	An L9 open TCB, used for OPENAPI programs that are in user key
UEPTX8	X8	An X8 open TCB, used for C and C++ programs, compiled with the XPLINK option, that are in CICS key

Table 1. TCB indicators in DFHUEPAR (continued). Description

Symbolic value	2-byte code	Description
UEPTX9	X9	An X9 open TCB, used for C and C++ programs, compiled with the XPLINK option, that are in user key

#### UEPSTACK

points to the kernel stack entry. This value must be moved to the exit program's register 13 before invoking the XPI. For more information, refer to Chapter 3, "The user exit programming interface (XPI)," on page 305. The storage addressed by this field **must not be altered**. If it is corrupted, your exit program will have unpredictable effects on your CICS system.

#### UEPXSTOR

points to a 320-byte area of DFHUEH-owned LIFO storage that the exit program should use when invoking the XPI. For more information, refer to Chapter 3, "The user exit programming interface (XPI)," on page 305.

#### UEPTRACE

points to the trace flag, which indicates whether tracing is on in the calling management module or domain. This enables you to control your use of the XPI TRACE\_PUT macro in line with the tracing in the CICS module or domain. The XPI TRACE\_PUT function should be used only when tracing is on. The trace flag is a single byte, whose top bit is set on when tracing is switched on. You test this setting using the symbolic value UEPTRON. The rest of the byte addressed by UEPTRACE is reserved, and its contents should not be corrupted.

## Returning values to CICS

At some exit points, you can influence what CICS does on return from an exit program by supplying a return code value.

You must set the return code value in register 15 before leaving the exit program.

- Use character string values rather than using hard-coded values. Character strings equating to valid return code values are provided with the parameter list for each exit point. For example, at exit XMNOUT in the monitor domain, you are presented with the address of a monitoring record. If you decide in your exit program that this record should not be written to SMF, you can set the return code value UERCBYP (meaning "bypass this record") before returning to CICS and CICS suppresses the record.
- If you have more than one exit program running for an exit point, use parameter **UEPCRCA** of DFHUEPAR to set the return code. For more information, see "Invoking more than one exit program at a single exit" on page 13
- If your exit program issues an EXEC CICS command and use the DFHEIENT macro, you must use this macro to set the return code. The DFHEIRET macro:
  - Restores registers
  - Places a return code in register 15 after the registers are restored
  - Returns control to the address in register 14.

For example:

```
DFHEIRET RCREG=nn
```

where *nn* is the number of any register (other than 13) that contains the return code to be placed in register 15 after the registers are restored.



If you supply a return code value that is not expected at a particular exit point, the default return code indicating a normal response (usually UERCNORM) is assumed, unless you set the return code UERCPURG. You are strongly advised not to let the return code default to the normal response as the result can be unpredictable. The normal response tells CICS to continue processing as if the exit program had not been invoked, and it is a valid option at most global user exit points. The exceptions are shown in the list of return codes provided with each exit description.

## Restrictions on the use of fields as programming interfaces

The *CICS Data Areas* manual contains definitions of the control block fields that form part of the Product-sensitive and General-use programming interfaces of CICS. Fields that are **not** defined in the *CICS Data Areas* manual as either Product-sensitive programming interface or General-use programming interface fields are **not** intended for your use as part of a CICS programming interface.

## Exit programs and the CICS storage protection facility

When you are running CICS with the storage protection facility, this affects the execution key in which your user exit programs run and the storage key of data storage that your exit programs obtains.

### Execution key for global user exit programs

When you are running with storage protection active, CICS always invokes global user exit programs in CICS key. Even if you specify EXECKEY(USER) on the program resource definition, CICS forces CICS key when it passes control to the exit program. However, if a global user exit program itself passes control to another program (via a link or transfer-control command), the program thus invoked is executed according to the execution key (EXECKEY) defined in its program resource definition.

You are strongly recommended to specify EXECKEY(CICS) when defining both global user exit programs and programs to which an exit program passes control.

### Data storage key for global user exit programs

The storage key of storage used by global user exit programs depends on how the storage is obtained:

- The CICS-supplied storage addressed by the **UEPXSTOR** parameter of DFHUEPAR, and any global work area specified when an exit program is enabled, are always in CICS key.
- Global user exit programs that can issue EXEC CICS commands can obtain storage by:
  - Explicit **EXEC CICS GETMAIN** commands
  - Implicit storage requests as a result of EXEC CICS commands that use the SET option.

The default storage key for storage obtained by EXEC CICS commands is set by the TASKDATAKEY of the transaction under which the exit program is invoked.

As an example, consider a transaction defined with TASKDATAKEY(USER) that issues a file control request, which causes an XFCREQ global user exit program to be invoked. In this case, any implicit or explicit storage acquired by the exit program by means of an EXEC CICS command is, by default, in user-key

storage. However, on an EXEC CICS GETMAIN command, the exit program can override the TASKDATAKEY option by specifying either CICS`DATAKEY` or USER`DATAKEY`.

- When an exit program obtains storage using an XPI GETMAIN call, the storage key depends on the value specified on the STORAGE\_CLASS option, which is mandatory, and which overrides the value of TASKDATAKEY.

## Exit programs and transaction isolation

When you are running CICS with the transaction isolation facility (TRANISO=YES), the exit program inherits the subspace of the application that caused the exit to be called.

If your GLUE needs to access storage belonging to a task other than the calling task, it can use the `DFHMSRX SWITCH_SUBSPACE XPI` command to switch to base space. It does not need to switch back to subspace mode before returning to CICS as CICS will restore the subspace mode if necessary.

## Errors in user exit programs

Because global user exit programs are an extension to CICS code, they are subject to the environment that CICS is running in when they are called.

If an error is detected at an exit point, CICS issues messages indicating which exit program was in error, the place in the program at which the error occurred, and the name of the associated exit point. The detection of an error is not guaranteed, because it depends on the CICS environment at the time of error, and on the nature of the error. For example, CICS might not recognize a looping user exit program, since the detection mechanism may have been turned off. Also, an abend in one of the exits XPCABND, XPCTA, or XSRAB may cause CICS to terminate abnormally, because an abend during abend processing causes CICS to terminate.

Exit programs invoked at some exit points (for example, XTSEREQ, XTSEREQC, XICEREQ, XICEREQC, XTDEREQ, or XTDEREQC) can enter a loop by issuing a recursive command (such as a TS command at exit point XTSEREQ). The exits most likely to be affected provide a recursion count parameter, UEPRECUR, that you can use to prevent such loops.

### Important

When coding user exit programs, you should bear in mind that the code is executed as an extension of CICS code, rather than as a transaction, and any errors could have disastrous results.

---

## Defining, enabling, and disabling an exit program

When you have written an exit program, you must define it to CICS.

1. Define the exit program using the `CEDA DEFINE PROGRAM` command, specifying `RELOAD(NO)`.
2. Install the exit program.
3. Enable the exit program using one of the following methods:
  - If your exit program is using an exit point in the user log record recovery program or the file control recovery control program, you can use the `TBEXITS` system initialization parameter.

- Otherwise, use the **EXEC CICS ENABLE** command to enable the user exit program.

If you enable a global user exit program before it has been installed and **LPA=YES** is specified as a system initialization parameter, CICS scans the LPA for the program. If message DFHLD0109I is issued, it means that CICS was unable to find the program in the LPA and is using the version in DFHRPL or a dynamic LIBRARY.

4. When you have finished using the exit program, you can disable it using the **EXEC CICS DISABLE** command.

For examples of how to enable and disable global user exit programs, see the sample programs listed in “Sample global user exit programs” on page 15.

---

## Viewing active global user exits

You can use the Web User Interface to view all of the global user exit programs that are running in your CICS regions.

You must have CICSplex SM installed and configured to perform this task.

1. Log on to the Web User Interface.
2. Select **Operations views > Exit operations views > Global user exits**. The global user exits view displays details for all of the programs that are using global user exit points in your CICS regions.
3. Select the name of the global user exit program that you are interested in to view the details of the program definition.

Using this view you can perform additional tasks such as enabling and disabling global user exit programs.

---

## Invoking more than one exit program at a single exit

You can invoke more than one exit program from a single global user exit point.

Although such programs can work independently, you should note the following points:

- An exit program is only called at an exit if it has been made available for execution with the **START** option of the **EXEC CICS ENABLE** command. The order of invocation, when more than one exit program has been started at an exit point, is the order in which the programs were activated (that is, the order in which the **EXEC CICS ENABLE** commands associated them with the exit point). When programs work on the same data area, you should consider the order in which they are invoked. For example, in a terminal control output exit, an exit program might manipulate the same message in different ways, depending on the way an earlier exit program acted.
- Return code management is more complicated than it is for single programs. Each exit program sets a return code in register 15 as usual. The second and subsequent programs invoked from a single exit point can access the return code value set by the preceding program (the “current return code”) using the parameter **UEPCRCA** of **DFHUEPAR**.

The following rules apply to return codes if a second user exit program sets a different return code value from that selected by the previous program:

- If the new program supplies the same return code value as the current return code (addressed by **UEPCRCA**), then CICS acts on that value.

- If the new program supplies a different return code value from the current value addressed by UEPCRCA, CICS ignores both values and resets the “current return code” to the default value, usually UERCNORM, before calling any further exit programs for that exit point.
- If the new program sets an eligible value in register 15 **and** changes the “current value” field to match (as addressed by UEPCRCA), the new value is adopted and passed on to the next program (if any), or back to the calling CICS module or domain.

The following code snippet shows how a new exit program can set a different return code from the “current return code” returned by a previous exit program, and cause CICS to act on the new code.

```

        LA   R15,UERCTDOK  Set the contents of reg 15 to a value of 4
        L   R6,UEPCRCA    Set reg 6 to the address of the half word
*                               containing the current return code
        STH R15,0(,6)     Store the new return code at the location
*                               of the current return code.
        . . .

```

---

## Invoking a single exit program at more than one exit

To invoke a single exit program from more than one exit point, you must issue an **ENABLE** command for each of the exit points.

For programming information about how to issue an **ENABLE** command, see the *CICS System Programming Reference*. Be careful to specify **GALENGTH** or **GAENTRYNAME** on only the first **ENABLE** command, otherwise 'INVEXITREQ' may be returned.

Take into account the restrictions that apply to the use of CICS services, because these are dictated by the exit point itself rather than by the exit program. A command that can be issued from one exit point might cause problems when issued from a different exit point.

The global work area is associated with the exit program, rather than with the exit point: this means that the same global work area is used at each of the exit points at which the exit program is invoked.

---

## Making programs threadsafe

All user programs defined by a **PROGRAM** resource definition have a **CONCURRENCY** attribute, which can be either **QUASIRENT** or **THREADSAFE**. By default, global user programs are defined as quasi-reentrant, which means they are given control on the CICS QR TCB.

If the task under which the global user exit is invoked is executing on an open TCB, and the exit program is defined as quasi-reentrant, CICS switches back to the QR TCB for the execution of the exit program.

To avoid unnecessary TCB switching, you are strongly recommended to make sure that your global user programs conform to threadsafe programming standards. When you are satisfied that your exit programs are threadsafe, ensure that they are defined as **CONCURRENCY(THREADSAFE)**. This is particularly important for exits that are invoked by tasks that are using the CICS DB2<sup>®</sup> interface and running under an L8 TCB.

If a CICS DB2 application program has been written and defined as threadsafe to obtain the benefits of the CICS open transaction environment (OTE), the benefit is lost if TCB switching is caused by a non-threadsafe exit program. You should pay particular attention to exit programs used on the mainline CICS-DB2 path: exit programs written for the XRMIIN and XRMIOU exit points need to be made threadsafe, as well as those invoked frequently, such as XEIIIN and XEIOU, which are invoked for every CICS API request.

To ensure that global user exit programs (such as those that run at the recovery exit points) are available as early as possible during CICS initialization, it is common practice to enable them from first-phase PLT programs. If you do this, bear in mind that, because first-phase PLT programs run so early in CICS initialization, no resource definitions are available. This means that you cannot use installed PROGRAM definitions (or the program autoinstall user program) to define the exit programs to CICS. Instead, default definitions are installed automatically by CICS. (This is known as “system-autoinstall”.) Note that this happens whether or not program autoinstall is specified as active on the PGAIPGM system initialization parameter. The autoinstall user program is not invoked to allow the definitions to be modified.

CICS installs exit programs that are enabled from first-phase PLT programs with CONCURRENCY(QUASIRENT); that is, the exit programs are defined as quasi-reentrant. To define a first-phase PLT global user exit program as threadsafe, specify the THREADSAFE keyword on the EXEC CICS ENABLE command. This overrides the CONCURRENCY(QUASIRENT) setting on the system-autoinstalled program definition. For more information about first-phase PLT programs, see “First-phase PLT programs” on page 425.

For more information, see the *CICS Application Programming Guide*.

---

## Sample global user exit programs

CICS provides two sets of sample and example global user exit programs.

1. A set that shows you how to do basic things, such as:
  - Enable a global user exit program and allocate a global work area
  - Use EXEC CICS and XPI commands in a global user exit program.
2. A set of samples for use at specific global user exit points.

The source of all the sample programs and any associated copy books is supplied in the CICSTS32.CICS.SDFHSAMP library. You can use the supplied programs as models on which to base your own versions.

## Basic sample and example programs

CICS supplies a number of samples to use when creating your global user exit programs.

### Global work area (GWA) sample exit programs

This set of sample programs shows you how to:

- Enable a global user exit program and allocate a global work area (GWA).
- Obtain the address of an exit program’s GWA.
- Access CICS system information, and make that information available to other global user exit programs.

- Share a GWA between global user exit programs, thereby making the information it contains available to more than one program, and overcoming limitations on the size of GWAs.
- Access information held in a global user exit program's GWA.

The GWA sample programs and copy books are:

#### **DFH\$PCEX**

A sample global user exit program, designed to be invoked at the XPCFTCH exit.

CICS also provides copy book DFH\$PCGA for use in this sample program.

#### **DFH\$ZCAT**

A sample global user exit program, designed to be invoked at the XZCATT exit.

CICS also provides copy book DFH\$ZCGA for use in this sample program.

#### **DFH\$PCPI and DFH\$PCPL**

DFH\$PCPI is designed to be invoked during program list table post initialization (PLTPI) processing, and is described in "The DFH\$PCPI program."

DFH\$PCPL is a dummy program, invoked by DFH\$PCPI, that causes the XPCFTCH user exit to be driven.

### **The DFH\$PCPI program**

DFH\$PCPI consists of three main sections:

1. Section 1 obtains and processes any parameters passed to DFH\$PCPI on the INITPARMS system initialization parameter.
2. Section 2 shows how to use standard CICS facilities to obtain system information, and make that information available to a global user exit program. It performs the following processing:
  - Uses the EXEC CICS ENABLE command to enable the XPCFTCH sample user exit program, DFH\$PCEX, and allocate it a global work area.
  - Uses the EXEC CICS EXTRACT EXIT command to obtain the address of DFH\$PCEX's global work area.
  - Obtains CICS system information, and places it in DFH\$PCEX's global work area. The information obtained includes:
    - Job name
    - Applid
    - Sysid
    - CICS release
    - Date in various formats, including DATFORM
    - The address of the common work area (CWA)
    - CICS startup type (COLD, WARM).

Most of the above information is obtained using EXEC CICS API commands such as:

- INQUIRE SYSTEM
- ASSIGN
- ADDRESS
- ASKTIME
- FORMATTIME.

- Uses the START option of the EXEC CICS ENABLE command to make DFH\$PCEX available for execution. This causes DFH\$PCEX to be driven for all LINKs and XCTLs.
  - Links to the dummy program, DFH\$PCPL, in order to drive DFH\$PCEX.
  - Uses the STOP option of the EXEC CICS DISABLE command to make DFH\$PCEX unavailable for execution. Note that this leaves DFH\$PCEX's global work area still allocated and accessible through the EXEC CICS EXTRACT EXIT command.
3. Section 3 of DFH\$PCPI shows how to share the system information in an exit program's global work area with other exit programs. (In doing so it demonstrates how application programs can access the same information by means of the EXEC CICS EXTRACT EXIT command.) It also shows how to use CICS shared storage to overcome the limitation of 32KB on the size of a GWA. The program obtains an area of 64KB below 16MB and an area of 128KB above 16MB (using GETMAIN). The use of shared storage enables the second user exit program (DFH\$ZCAT) to use a work area of only 12 bytes below 16MB.

The section performs the following processing:

- Uses EXEC CICS ENABLE to enable the DFH\$ZCAT user exit program, and allocate it a global work area
- Uses EXEC CICS EXTRACT EXIT to obtain the address of DFH\$ZCAT's global work area
- Stores the address of DFH\$PCEX's global work area in DFH\$ZCAT's global work area
- Uses GETMAIN to obtain the shared storage above and below the 16MB line, and stores the addresses in DFH\$ZCAT's global work area.

### Sample program definitions

The following are examples of the RDO definitions required to define the sample programs to the CSD:

```
DEFINE PROGRAM(DFH$PCEX) GROUP(EXITGRP)
    LANGUAGE(ASSEMBLER) RELOAD(NO) RESIDENT(NO) USAGE(NORMAL)
    USELPACOPY(NO) STATUS(ENABLED) CEDF(YES) DATALOCATION(ANY)
    EXECKEY(CICS)
```

```
DEFINE PROGRAM(DFH$PCPI) GROUP(EXITGRP)
    LANGUAGE(ASSEMBLER) RELOAD(NO) RESIDENT(NO) USAGE(NORMAL)
    USELPACOPY(NO) STATUS(ENABLED) CEDF(YES) DATALOCATION(ANY)
    EXECKEY(CICS)
```

```
DEFINE PROGRAM(DFH$PCPL) GROUP(EXITGRP)
    LANGUAGE(ASSEMBLER) RELOAD(NO) RESIDENT(NO) USAGE(NORMAL)
    USELPACOPY(NO) STATUS(ENABLED) CEDF(YES) DATALOCATION(ANY)
    EXECKEY(CICS)
```

```
DEFINE PROGRAM(DFH$ZCAT) GROUP(EXITGRP)
    LANGUAGE(ASSEMBLER) RELOAD(NO) RESIDENT(NO) USAGE(NORMAL)
    USELPACOPY(NO) STATUS(ENABLED) CEDF(YES) DATALOCATION(ANY)
    EXECKEY(CICS)
```

DFH\$PCPI is designed to be run as a PLT program. If you write a similar program, you should define it in the **second** part of the PLTPI list (after the PROGRAM=DFHDELIM entry). Information about how to do this is in the *CICS Resource Definition Guide*.

## Example program

As well as the sample programs supplied in source code, there is an example listing, DFH\$XTSE, that shows you how to:

- Use EXEC CICS commands in a global user exit program
- Use EXEC CICS commands and XPI calls in the same exit program
- Modify the command parameter list in EXEC interface exits such as XTSEREQ and XICEREQ.

DFH\$XTSE is listed on page Appendix F, “The example program for the XTSEREQ global user exit, DFH\$XTSE,” on page 877.

## Sample programs for specific exits

Certain user exit points have sample programs that demonstrate how you can use the exit point in your global user exit programs.

### The Application Associated Data sample exit program

CICS supplies a sample global user exit program for the Application Associated Data exit:

#### DFH\$APAD

A sample global user exit program, designed to be invoked at the XAPADMGR exit. The program shows how you can add user information to a transaction's Associated Data Origin Descriptor, or retrieve existing information found in the association data, for purposes such as auditing or accounting of workloads.

#### Related reference

“Application Associated Data exit, XAPADMGR, in the AP domain” on page 33  
Use the XAPADMGR exit for distributed transactions. It allows you to add user information to a task's Associated Data Origin Descriptor, at the point of origin of the distributed transaction. This information could later be used as, for example, search keys for processing carried out through CICSplex SM.

### The Basic Mapping Support sample exit program

CICS supplies a sample global user exit program for the Basic Mapping support exits:

#### DFH\$BMXT

A sample global user exit program, designed to be invoked at the XBMIN and XBMOU exits. The program shows how you can use the exits to modify mapped input and output data.

#### Related concepts

“Basic Mapping Support exits XBMIN and XBMOU” on page 34

### The data tables sample exit programs

CICS supplies one sample global user exit program for each of the data tables exit points. These are:

#### DFH\$DTAD

A sample global user exit program, designed to be invoked at the XDTAD exit.

#### DFH\$DTLC

A sample global user exit program, designed to be invoked at the XDTLC exit.



**DFH\$DTRD**

A sample global user exit program, designed to be invoked at the XDTRD exit.

DFH\$DTAD, DFH\$DTLC, and DFH\$DTRD are listed in the *CICS Shared Data Tables Guide*.

**Related concepts**

“Data tables management exits XDTRD, XDTAD, and XDTLC” on page 40  
Data tables management exits apply to both CICS shared data tables and CICS coupling facility data tables.

**The dump domain sample exit program**

There is one dump domain sample global user exit program:

**DFH\$XDRQ**

A sample global user exit program, designed to be invoked at the XDUREQ exit.

**Related concepts**

“Dump domain exits XDUREQ, XDUREQC, XDUCLESE, and XDUOUT” on page 53

**Related reference**

“Exit XDUREQ” on page 53

**The enqueue EXEC interface sample exit program**

There is one sample global user exit program for the enqueue EXEC interface.

**DFH\$XNQE**

A sample global user exit program, designed to be invoked at the XNQEREQ and XNQEREQC exits. The program demonstrates three ways of adding a SCOPE value to EXEC CICS ENQ and DEQ requests, to make the requests apply to multiple regions within the sysplex.

**Related concepts**

“Sample exit program, DFH\$XNQE” on page 66

**The file control state program sample exit program**

There is one sample global user exit program for the file control state program.

**DFH\$REQC**

A sample user exit program, designed to be invoked at the XFCSREQC exit. It allows you to check VSAM error flags after file requests have been acted upon and, optionally, to write messages and data areas to a system console or a transient data queue. See “The DFH\$REQC sample global user exit program” on page 120.

**Related concepts**

“The DFH\$REQC sample global user exit program” on page 120

**The file control recovery program sample exit programs**

CICS provides three sample file control global user exit programs:

**DFH\$FCBF**

A sample exit program designed to be invoked at the XFCBAIL exit for handling backout failures. See “DFH\$FCBF sample global user exit program” on page 130.

**DFH\$FCBV**

A sample exit program designed to be invoked at the XFCBOVER exit; it allows you to decide whether to allow an update to be backed out, following

a batch update run that has overridden retained locks. See “DFH\$FCBV sample global user exit program” on page 134.

### **DFH\$FCLD**

A sample exit program designed to be invoked at the XFCLDEL exit, which allows you to perform logical deletion of records from a VSAM ESDS data set or a BDAM data set, during backout. See “DFH\$FCLD sample global user exit program” on page 136.

You can define these programs by including the supplied resource group, DFH\$FCB, in your startup grouplist, or by using CEDA to install DFH\$FCB.

#### **Related concepts**

“DFH\$FCBF sample global user exit program” on page 130

“DFH\$FCBV sample global user exit program” on page 134

“DFH\$FCLD sample global user exit program” on page 136

### **The function-shipping and DPL queue control sample exit program**

You can use the XISCONA sample global user exit program to control the queueing of function-shipping and DPL requests:

#### **DFHXIS**

A sample global user exit program, designed to be invoked at the XISCONA exit.

#### **Related concepts**

“The sample XISCONA global user exit program, DFHXIS” on page 140

### **The HTTP client sample exit programs**

These sample programs are for use with the Web domain exits, XWBOPEN and XWBAUTH,.

The XWBOPEN exit is invoked during processing of **EXEC CICS WEB OPEN** and **EXEC CICS INVOKE WEBSERVICE** commands. XWBAUTH is called during processing of an **EXEC CICS WEB SEND** and **EXEC CICS WEB CONVERSE** commands. Both exits are used in making HTTP client requests from CICS as an HTTP client, which is a facility provided by CICS Web support.

The following sample exit programs are shipped in the CICS sample library, SDFHSAMP:

- DFH\$WBPI, described in “DFH\$WBPI”
- DFH\$WBEX, described in “DFH\$WBEX” on page 21
- DFH\$WBX1, described in “DFH\$WBX1” on page 21
- DFH\$WBX2, described in “DFH\$WBX2” on page 22
- DFH\$WBGA, a copybook to map the global work area used by the DFH\$WBPI, DFH\$WBX1, DFH\$WBX2, and DFH\$WBEX samples.

#### **DFH\$WBPI**

This program, whose purpose is to initialize the supplied Web-related global user exits, is specified in the PLTPI and is invoked during the CICS post-initialization phase. It is specified with the **INITPARM** system initialization parameter as follows:

```
INITPARM=(DFH$WBPI='PROXY=proxyur1,LDAPBIND=prof ilename,STS=sts-server-ur1')
```

where

**PROXY=proxyurl**

This optional keyword stores the URL (in the form `http://proxyserver`) of a proxy server into the Web global work area, then enables the supplied DFH\$WBEX sample program as the XWBOPEN global user exit.

**LDAPBIND=profilename**

This optional keyword stores the name of an LDAP bind profile into the Web global work area, then enables the supplied DFH\$WBX1 sample program as the XWBAUTH global user exit.

Note that you cannot specify both LDAPBIND and STS. To do so causes DFH\$WBPI to abend with code WBPI. Message DFHSD1580D is issued, which may cause CICS to be terminated.

**STS=sts-server-url**

This optional keyword stores the URL (usually in the form `https://sts-server`) of a Secure Token Service into the Web global work area, then enables the supplied DFH\$WBX2 sample program as the XWBAUTH global user exit.

Note that you cannot specify both STS and LDAPBIND. To do so causes DFH\$WBPI to abend with code WBPI. Message DFHSD1580D is issued, which may cause CICS to be terminated.

Note that the total length of the INITPARM quoted text cannot exceed 60 characters.

**DFH\$WBEX**

This sample global user exit program is designed to check the host name specified on the **EXEC CICS WEB OPEN** command, and make any host name starting with `www` use a proxy server if a proxy server name is specified in the global work area.

If all the requests from your CICS system should use a single proxy server, you can use the proxy server name from the **INITPARM** system initialization parameter, that DFH\$WBPI used to initialize the global work area.

- The proxy name must be specified as:

```
INITPARM=(DFH$WBPI='PROXY=proxyurl')
```

where `proxyurl` is the URL if a proxy server. If you use a number of proxy servers or want to apply a security policy to different host names, you can load or build a table that matches host names to appropriate proxy servers or marks them as barred, which can then be used as a look-up table during processing of the **EXEC CICS WEB OPEN** command.

**DFH\$WBX1**

This sample global user exit program has the following functions:

- If a GLUE global workarea is provided and it contains a non-zero LDAP connection token, it uses that token in subsequent SEARCH requests.
- If the exit is called at the XSTERM (system termination) exit point, it terminates the LDAP connection by invoking the DFHDDAP UNBIND\_LDAP function. Otherwise, it obtains a connection token by issuing DFHDDAP BIND\_LDAP and stores it in the global workarea. The LDAPBIND profile specified in the INITPARM parameter for DFH\$WBPI is used to obtain LDAP credentials.
- Composes a distinguished name in the following format: `racfid=uuuuuuuu, ibm-httprealm=rrrrrrrr, labeledURI=xxxxxxx, cn=BasicAuth` where:

**racfcid=uuuuuuuu**

is the current userid, obtained from UEPUSER

**ibm-httprealm=rrrrrrrr**

is the HTTP 401 realm, obtained from UEPREALM (if this exists)

**labeledURI=xxxxxxx**

is the target URL, obtained by concatenating "http://" with the hostname from UEPHOST and the path from UEPPATH

**cn=BasicAuth**

is an arbitrary suffix that is configured into the LDAP server for the purpose of storing Basic Authentication credentials.

- Issues DFHDDAP SEARCH\_LDAP with this distinguished name
- If the SEARCH\_LDAP fails, DFH\$WBX1 removes the REALM parameter from the distinguished name and repeats the search. If the search fails again, DFH\$WBX1 removes the **UID** parameter from the distinguished name and repeats the search. If the search fails for the third time, DFH\$WBX1 returns from the exit with return code UERCERR.
- If the search was successful, issue DFHDDAP START\_BROWSE\_RESULTS
- Obtains the target **username** credential by obtaining the value of the **UID** attribute with DFHDDAP GET\_ATTRIBUTE\_VALUE. This is set into the response area provided by UEPUSNM.
- Obtains the target **password** credential by obtaining the value of the **UserPassword** attribute with DFHDDAP GET\_ATTRIBUTE\_VALUE. This is set into the response area provided by UEPPSWD.
- Releases the browse storage by issuing DFHDDAP END\_BROWSE\_RESULTS
- If the bind token was not stored in the global workarea, terminate the LDAP session by issuing DFHDDAP UNBIND\_LDAP
- If all is successful, DFH\$WBX1 returns from the exit with return code UERCNORM.

**DFH\$WBX2**

This sample global user exit program has the following functions:

- Obtains the destination HTTP host from UEPHOST/UEPHOSTL and the destination HTTP path from UEPPATH/UEPPATHL, and uses them to construct the URL of the HTTP server for which the basic authentication credentials are required, as follows: http://hostname/pathname.
- If a realm exists (that is, if UEPREALML is non-zero), DFH\$WBX2 appends the realm from UEPREALM to the URL created above, separated by a number sign (#) to make it look like a URL fragment identifier, as follows: http://hostname/pathname#realm. If necessary, the realm is URL-encoded.
- Stores the URL in the DFHWS-SERVICEURI container in the DFHWSTC-V1 channel.
- Stores the URL of the Security Token Service (STS), obtained from the global work area, in the DFHWS-STSURURI container in the DFHWSTC-V1 channel.
- Stores architecturally appropriate URIs into the DFHWS-STSACTION and DFHWS-TOKENTYPE containers in the DFHWSTC-V1 channel.
- Constructs a username token from the caller's userid passed in UEPUSER, and store it in the DFHWS-IDTOKEN container in the DFHWSTC-V1 channel.
-

**Note:** It is not necessary to specify a pipeline in the DFHWS-PIPELINE container. The pipeline is dynamically created by DFHPIRT when CHANNEL(DFHWSTC-V1) is specified on the command.

- Links to DFHPIRT, specifying CHANNEL(DFHWSTC-V1), after constructing all the required containers. This sends the request to the STS and receives the response into the DFHWS-RESTOKEN container.
- If the LINK was successful, DFHWPBX2 recovers the response from the DFHWS-RESTOKEN container, which contains an username token in XML format.
- Extracts the username and password from this token, and returns them as responses from the user exit in UEPUSNM/UEPUSNML and UEPPSWD/UEPPSWDL. Returns from the user exit with return code UERCNORM.
- If the LINK was unsuccessful, or if a SOAP fault response is returned, DFHWPBX2 returns from the exit with return code UERCERR.

The above implementation assumes that the STS server is configured to respond with an appropriate username token when presented with the URI formatted by DFHWPBX2 in the AppliesTo element of the STS issue request.

#### **Related concepts**

“HTTP client open and send exits: XWBAUTH, XWBOPEN and XWBSNDO” on page 138

### **The interval control EXEC interface sample exit program**

#### **DFH\$ICCN**

A sample global user exit program, designed to be invoked at the XICERREQ exit. DFH\$ICCN is for use in a distributed routing environment, where you want to cancel a previously-issued interval control request but have no way of knowing to which region to direct the CANCEL. For examples of situations which DFH\$ICCN is designed to cope with, see *Canceling interval control requests*, in the *CICS Intercommunication Guide*.

#### **Related concepts**

“Example of how XICERREQ and XICEREQC can be used” on page 161

### **The log manager domain sample exit program**

There is one sample global user exit program for the XLGSTRM exit point:

#### **DFH\$LGLS**

The sample program shows you how to change some of the parameters—for example, the model log stream name—used by the MVS system logger when it creates a new log stream dynamically. The sample is described on page “The sample program for the XLGSTRM exit, DFH\$LGLS” on page 167.

#### **Related concepts**

“The sample program for the XLGSTRM exit, DFH\$LGLS” on page 167

### **The message domain sample exit programs**

These sample programs show you how to write a program to be invoked at the XMEOUT exit, to do a specific task. For example, the DFH\$XPN4 sample program shows you how to use the XMEOUT exit to reroute a console message to a transient data queue.

#### **DFH\$XPN**

A set of sample global user exit programs designed to be invoked at the XMEOUT exit (where ‘n’ is 1 through 6).

**Related concepts**

“The sample XMEOUT global user exit programs” on page 171

**The MRO and APPC session queue management sample exit program**

This sample program implements the same basic function provided by the QUEUELIMIT and MAXQTIME parameters on a connection resource definition. These parameters are passed to the XZIQUE global user program, which can change the way in which these parameters are used:

**DFH\$XZIQ**

A sample global user exit program, designed to be invoked at the XZIQUE exit, which is described on page “XZIQUE exit for managing MRO and APPC intersystem queues” on page 249.

See “Sample exit program design” on page 256 for more details.

**Related concepts**

“Designing an XZIQUE global user exit program” on page 256

**The pipeline sample exit program**

The DFH\$PIEX sample global user exit program provides sample processing for the XWSPRROO global user exit.

If you enable this sample program, it is invoked in a Web service provider pipeline after the Web service provider application has finished processing and returned to CICS, but before CICS creates the response message SOAP body.

The sample program retrieves the name of the Web service, the name of the transaction, and all of the attributes of the Web service.

**Related reference**

“Exit XWSPRROO” on page 174

Use the XWSPRROO exit to access containers on the current channel after the Web services provider application issues the Web service response message and before CICS creates the body of the response message.

**The session queue management sample exit program, for IPIC connections**

This sample program implements the same basic function provided by the QUEUELIMIT and MAXQTIME parameters on a connection resource definition. These parameters are passed to the XISQUE global user program, which can change the way in which these parameters are used:

**DFH\$XISQ**

A sample global user exit program, designed to be invoked at the XISQUE exit, which is described on page “XISQUE exit for managing IPIC intersystem queues” on page 258.

See “The sample exit program, DFH\$XISQ” on page 262 for more details.

**Related concepts**

“XISQUE exit for managing IPIC intersystem queues” on page 258

**The transaction-abend sample exit program**

There is one sample global user exit program for the XPCTA exit point:

**DFH\$PCTA**

This sample global user exit program is designed to be invoked at the

XPCTA exit, to test whether the abend was caused by a storage protection exception condition. It is described on page “The sample XPCTA global user exit program, DFH\$PCTA” on page 191.

**Related concepts**

“The sample XPCTA global user exit program, DFH\$PCTA” on page 191

**The terminal-not-known sample exit program**

You can use this sample global user exit program to handle terminal-not-known conditions arising from START and ATI requests:

**DFHXTENF**

A sample global user exit program, designed to be invoked at the XALTENF or XICTENF exit. The sample source code is shown on page “The sample program for the XALTENF and XICTENF exits, DFHXTENF” on page 230.

**Related concepts**

“The sample program for the XALTENF and XICTENF exits, DFHXTENF” on page 230

---

## Alphabetical list of global user exit points

The global user exit points are listed in alphabetical order, giving a brief description and a reference to where you can find more information about each exit.

*Table 2. Alphabetical list of global user exit points*

Exit name	Module or domain	Where or when invoked	Topic
XAKUSER	Activity keypoint program	Immediately before the 'end of keypoint' record is written.	“Activity keypoint program exit XAKUSER” on page 32
XALCAID	Terminal allocation program	Whenever an AID with data is canceled.	“Exit XALCAID” on page 221
XALTENF		When an ATI request from transient data or interval control requires a terminal that is unknown in this system.	“Exit XALTENF” on page 226
XAPADMGR	Application domain	When a non-system task that has no inherited Associated Data Origin Descriptor data is attached.	“Application Associated Data exit, XAPADMGR, in the AP domain” on page 33
XBMIN	Basic Mapping Support	When an input mapping operation completes successfully.	“Exit XBMIN” on page 35
XBMOUT		When a page of output has been built successfully.	“Exit XBMOUT” on page 35
XDLIPOST	DL/I interface program	On exit from the DL/I interface program.	“Exit XDLIPOST” on page 51
XDLIPRE		On entry to the DL/I interface program.	“Exit XDLIPRE” on page 49
XDSAWT	Dispatcher domain	After an operating system wait.	“Exit XDSAWT” on page 48
XDSBWT		Before an operating system wait.	“Exit XDSBWT” on page 47

Table 2. Alphabetical list of global user exit points (continued)

Exit name	Module or domain	Where or when invoked	Topic
XDTAD	Data tables management	When a write request is issued to a data table.	“Exit XDTAD” on page 43
XDTLC		At the completion of loading of a data table.	“Exit XDTLC” on page 44
XDTRD		During the loading of a data table, whenever a record is retrieved from the source data set.	“Exit XDTRD” on page 41
XDUCLSE	Dump domain	After the domain closes a transaction dump data set.	“Exit XDUCLSE” on page 59
XDUOUT		Before the domain writes a record to the transaction dump data set.	“Exit XDUOUT” on page 59
XDUREQ		Before the domain takes a system or transaction dump.	“Exit XDUREQ” on page 53
XDUREQC		After a system or transaction dump has been taken (or failed or been suppressed).	“Exit XDUREQC” on page 56
XEIIN	EXEC interface program	Before the execution of any EXEC CICS API or SPI command.	“Exit XEIIN” on page 69
XEIOUT		After the execution of any EXEC CICS API or SPI command.	“Exit XEIOUT” on page 71
XEISPIN		Before the execution of any EXEC CICS SPI command <i>except</i> EXEC CICS ENABLE, EXEC CICS DISABLE, EXEC CICS EXTRACT EXIT, EXEC CICS PERFORM DUMP, or EXEC CICS RESYNC ENTRYNAME.	“Exit XEISPIN” on page 70
XEISPOUT		After the execution of any EXEC CICS SPI command <i>except</i> EXEC CICS ENABLE, EXEC CICS DISABLE, or EXEC CICS EXTRACT EXIT, EXEC CICS PERFORM DUMP, or EXEC CICS RESYNC ENTRYNAME.	“Exit XEISPOUT” on page 71
XFAINTU	3270 bridge facility management program	When a bridge facility is created or deleted.	“Bridge facility exit XFAINTU” on page 38
XFCAREQ	File control EXEC interface program	Before CICS processes a file control SPI request.	“File control EXEC interface SPI exits XFCAREQ and XFCAREQC” on page 98
XFCAREQC		After a file control SPI request has completed.	“File control EXEC interface SPI exits XFCAREQ and XFCAREQC” on page 98



Table 2. Alphabetical list of global user exit points (continued)

Exit name	Module or domain	Where or when invoked	Topic
XFCBFAIL	File control recovery control program	When an error occurs during the backout of a UOW.	“Exit XFCBFAIL, file control backout failure exit” on page 127
XFCBOUT		When CICS is about to back out a file update.	“Exit XFCBOUT, file control backout exit” on page 131
XFCBOVER		When CICS is about to skip backout of a UOW because a batch program has overridden RLS retained lock protection and opened a data set for batch processing.	“Exit XFCBOVER, file control backout override exit” on page 132
XFCLDEL		When backing out writes to a VSAM ESDS or a BDAM data set.	“Exit XFCLDEL, file control logical delete exit” on page 135
XFCFRIN	File control domain	Before the execution of a file control request.	“XFCFRIN” on page 72
XFCFROUT		After the execution of a file control request.	“XFCFROUT” on page 73
XFCNREC	File control open/close program	When a mismatch is detected between the backout recovery setting for a file and its associated data set during file open processing.	Exit XFCNREC
XFCQUIS	File control quiesce send program	On completion, successful or failed, of a SET DSNAME QUIESCESTATE command.	“File control quiesce send exit XFCQUIS” on page 124
XFCREQ	File control EXEC interface program	Before CICS processes a file control API request.	“Exit XFCREQ” on page 95
XFCREQC		After a file control API request has completed.	“Exit XFCREQC” on page 96
XFCSREQ	File control file state program	Before a file OPEN, CLOSE, ENABLE, or DISABLE command is attempted.	“File control file state program exits XFCSREQ and XFCSREQC” on page 111
XFCSREQC		After a file OPEN, CLOSE, CANCEL CLOSE, ENABLE, or DISABLE command has been completed.	“File control file state program exits XFCSREQ and XFCSREQC” on page 111
XFCVSDS	File control quiesce receive program	After RLS has informed CICS that processing is required as a result of a data set-related action occurring in the sysplex.	“File control quiesce receive exit, XFCVSDS” on page 122
XGMTEXT	“Good morning” message program	Before the “good morning” message is sent.	“Good morning message program exit XGMTEXT” on page 138

Table 2. Alphabetical list of global user exit points (continued)

Exit name	Module or domain	Where or when invoked	Topic
XICERREQ	Interval control EXEC interface program	Before CICS processes an interval control API request.	“Exit XICERREQ” on page 146
XICEREQC		After an interval control API request has completed.	“Exit XICEREQC” on page 149
XICERES		Before CICS processes a non-terminal-related EXEC CICS START request that has been dynamically routed to this region, where the routing region supports the “resource unavailable” (RESUNAVAIL) condition.	“Exit XICERES” on page 148
XICEXP	Interval control program	After expiry of an interval control time interval.	“Exit XICEXP” on page 144
XICREQ		At the start of the interval control program, before request analysis.	“Exit XICREQ” on page 143
XICTENF		When an EXEC CICS START command requires a terminal that is unknown in this system.	“Exit XICTENF” on page 228
XISCONA	Intersystem communication program	When a function shipping or DPL request is about to be queued because no sessions to the remote region are immediately available.	“Intersystem communication program exits XISCONA and XISLCLQ” on page 138
XISLCLQ		After an attempt to allocate a session for a function shipped START NOCHECK request fails because the remote system is not in service, a connection to the remote system cannot be established, or no sessions are immediately available and your XISCONA exit program has specified that the request is not to be queued in the issuing region.	“The XISLCLQ exit” on page 141
XISQUE	To control the number of queued requests for sessions on IPCONNs	When: <ol style="list-style-type: none"> <li>1. An allocate request for a session on an IPCONN is about to be queued</li> <li>2. An IP allocate request succeeds following previous suppression of queuing</li> </ol>	“XISQUE exit for managing IPIC intersystem queues” on page 258
XLDELETE	Loader domain	After an instance of a program is released by CICS and just before the program is freed from storage.	“Exit XLDELETE” on page 163
XLDLOAD		After an instance of a program is brought into storage, and before the program is made available for use.	“Exit XLDLOAD” on page 163
XLGSTRM	Log manager domain	After the CICS log manager detects that a log stream does not exist, and before calling the MVS system logger to define the log stream.	“Log manager domain exit XLGSTRM” on page 164
XMEOUT	Message domain	Before a message is sent from the message domain to its destination.	“Exit XMEOUT” on page 169
XMNOUT	Monitoring domain	Before a record is either written to SMF or buffered before a write to SMF.	“Exit XMNOUT” on page 172
XNQERREQ	Enqueue EXEC interface program	Before CICS processes an enqueue API request.	“Exit XNQERREQ” on page 60
XNQEREQC		After an enqueue API request has completed.	“Exit XNQEREQC” on page 61

Table 2. Alphabetical list of global user exit points (continued)

Exit name	Module or domain	Where or when invoked	Topic
XPCABND	Program control program	After a transaction abend and before a dump call is made.	"Exit XPCABND" on page 192
XPCERES		Before CICS processes a program link or Link3270 bridge request that has been dynamically routed to this region, where the routing region supports the "resource unavailable" (RESUNAVAIL) condition.	"Exit XPCERES" on page 178
XPCFTCH		Before an application program is given control.	"Exit XPCFTCH" on page 186
XPCHAIR		Before a HANDLE ABEND routine is given control.	"Exit XPCHAIR" on page 188
XPCREQ		Before a program link request is processed.	"Exit XPCREQ" on page 177
XPCREQC		After a program link request has been completed.	"Exit XPCREQC" on page 179
XPCTA		After an abend occurs, and before the environment is modified.	"Exit XPCTA" on page 190
XRCINIT		User log record recovery program	During warm and emergency restart, if user recovery log records are detected in the CICS system log.
XRCINPT	During warm and emergency restart, for each user recovery log record found in the CICS system log.		"Exit XRCINPT" on page 246
XRMIIN	Resource manager interface program	Before execution of an EXEC DLI, EXEC SQL, or RMI command.	"Exit XRMIIN" on page 193
XRMIOUT		After execution of an EXEC DLI, EXEC SQL, or RMI command.	"Exit XRMIIN" on page 193
XRSINDI	Resource management modules	Immediately after a successful install or discard of a resource.	"Resource management install and discard exit XRSINDI" on page 195
XSNEX	Security manager domain	Restore old CICS signon and signoff behavior (pre-CICS TS 2.1)	"Exit XSNEX" on page 201
XSNOFF		After a terminal user signs off.	"Exit XSNOFF" on page 200
XSNON		After a terminal user signs on.	"Exit XSNON" on page 199
XSTERM	System termination program	During a normal system shutdown, immediately before TD buffers are cleared.	"Exit XSTERM" on page 206
XSTOUT	Statistics domain	Before a statistics record is written to SMF.	"Exit XSTOUT" on page 202

Table 2. Alphabetical list of global user exit points (continued)

Exit name	Module or domain	Where or when invoked	Topic
XSZARQ	Front End Programming Interface	After a FEPI request has completed.	"Front End Programming Interface exits XSZARQ and XSZBRQ" on page 137
XSZBRQ		Before a FEPI request is actioned.	"Front End Programming Interface exits XSZARQ and XSZBRQ" on page 137
XTCATT	Terminal control program	Before task attach.	"Exit XTCATT" on page 224
XTCIN		After an input event.	"Exit XTCIN" on page 223
XTCOUT		Before an output event.	"Exit XTCOUT" on page 223
XTDEREQ	Transient data EXEC interface program	Before CICS processes a transient data API request.	"Exit XTDEREQ" on page 237
XTDEREQC		After a transient data API request has completed.	"Exit XTDEREQC" on page 238
XTDIN	Transient data program	After receiving data from QSAM (extrapartition) or VSAM (intrapartition).	"Exit XTDIN" on page 234
XTDOUT		Before passing data to a QSAM (extrapartition) or VSAM (intrapartition) user-defined transient data queue.	"Exit XTDOUT" on page 235
XTDREQ		Before request analysis.	"Exit XTDREQ" on page 234
XTSREQ	Temporary storage EXEC interface program	Before CICS processes a temporary storage API request.	"Exit XTSREQ" on page 213
XTSREQC		After a temporary storage API request has completed.	"Exit XTSREQC" on page 214
XTSPTIN	Temporary storage domain	Before invocation of a TSPT function.	"Exit XTSPTIN" on page 210
XTSPTOUT		After invocation of a TSPT function.	"Exit XTSPTOUT" on page 211
XTSQRIN		Before invocation of a TSQR function.	"Exit XTSQRIN" on page 207
XTSQROUT		After invocation of a TSQR function.	"Exit XTSQROUT" on page 208

Table 2. Alphabetical list of global user exit points (continued)

Exit name	Module or domain	Where or when invoked	Topic
XWBAUTH	Web domain	During processing of an EXEC CICS WEB SEND command.	“HTTP client open and send exits: XWBAUTH, XWBOPEN and XWBSNDO” on page 138
XWBOPEN		During processing of an EXEC CICS WEB OPEN or EXEC CICS INVOKE WEBSERVICE command.	“HTTP client open and send exits: XWBAUTH, XWBOPEN and XWBSNDO” on page 138
XWBSNDO		During processing of an EXEC CICS WEB SEND command.	“HTTP client open and send exits: XWBAUTH, XWBOPEN and XWBSNDO” on page 138
XWSPRROO	Pipeline domain	After the Web service provider application returns and before CICS creates the body of the response message.	“Exit XWSPRROO” on page 174
XXDFA	DBCTL interface control program	In the active CICS when CICS-DBCTL connection fails.	“DBCTL interface control program exit XXDFA” on page 45
XXDFB	DBCTL tracking program	In the alternate CICS when DBCTL fails.	“Exit XXDFB” on page 46
XXDTO		In the alternate CICS when active DBCTL fails.	“Exit XXDTO” on page 46
XXMATT	Transaction manager domain	When a user transaction is attached.	“Exit XXMATT” on page 232
XXRSTAT	XRF request processing program	After a VTAM® failure or a predatory takeover.	“Exit XXRSTAT” on page 264
XZCATT	VTAM terminal management program	Before task attach.	“Exit XZCATT” on page 247
XZCIN	VTAM working set module	After an input event.	“Exit XZCIN” on page 248
XZCOUT		Before an output event.	“Exit XZCOUT” on page 248
XZCOUT1		Before a message is broken into RUs.	“Exit XZCOUT1” on page 249
XZIQUE		<ol style="list-style-type: none"> <li>1. When an allocate request for a session is about to be queued.</li> <li>2. When an allocate request succeeds following previous suppression of queuing.</li> </ol>	“XZIQUE exit for managing MRO and APPC intersystem queues” on page 249

---

## Global user exit points by functional area

The exit points are grouped according to their functional relationships. This usually means according to the CICS module or domain in which they occur. However, where exit points in different modules serve a similar function, the exits are grouped under a generic name. The groups of exits are presented in alphabetical order of module or generic name.

Each of the global user exit points is described in detail, including:

- The exit identifier
- The location of the exit
- The DFHUEPAR parameters, if any, that are unique to the exit
- The return codes that are valid for this exit point
- XPI calls that can be invoked.

### Activity keypoint program exit XAKUSER

The XAKUSER exit is invoked during the activity keypointing process. You can use this exit to record, on the system log, user data that must be restored following an emergency restart.

For best performance, journal control requests should not specify WAIT. CICS will force the records by writing a synchronous end of keypoint record upon return from the exit program.

Your exit program should be translated with the NOEDF option. Any program it links to should also be translated with this option. It is not possible to link to programs written in PL/I.

To ensure that it is called during every keypoint, your exit program should be enabled by means of a first phase PLTPI program - see "Writing initialization programs" on page 425. However, if it enabled at this stage, your program should not attempt to link to any program coded in COBOL or C, as it might be invoked before these are initialized.

#### Important

Your exit program forms part of a critical CICS system activity. If it fails, CICS terminates. Only the listed EXEC CICS commands are allowed in the XAKUSER exit. The exit should link only to other programs with the same restrictions.

#### Exit XAKUSER

##### When invoked

During the activity keypointing process.

##### Exit-specific parameters

###### UEPAKTYP

Address of a 1-byte field indicating the type of keypoint for which the exit is invoked. The possible values are:

###### UEPAKPER

Activity keypoint

###### UEPAKWSD

Warm shutdown keypoint.

## Return codes

### UERCNORM

Continue processing.

## XPI calls

XPI must not be used.

## API and SPI calls

The following commands are supported:

- ADDRESS CWA
- ADDRESS EIB
- LINK (but only to local programs; distributed program links may not be used).
- RETURN
- WRITE JOURNALNAME.

## Application Associated Data exit, XAPADMGR, in the AP domain

Use the XAPADMGR exit for distributed transactions. It allows you to add user information to a task's Associated Data Origin Descriptor, at the point of origin of the distributed transaction. This information could later be used as, for example, search keys for processing carried out through CICSplex SM.

The exit program is invoked, if enabled, at the attach of non-system tasks for which no input Origin Descriptor Record is provided.

On input, the exit program is passed the task's association data. It could find other relevant information, for inclusion in the Associated Data Origin Descriptor, from other sources, using CICS commands.

**Note:** Distributed transactions that use DPL over IPIC connections pass their transaction group ID and origin data, including the user correlator, to be inherited by the mirror task in the target region.

The exit program could perform other activities, such as logging of information found in the association data, for purposes such as auditing or accounting of workloads.

## Exit XAPADMGR

### When invoked

At the attach of a non-system task that has no inherited Associated Data Origin Descriptor data passed to it.

### Exit-specific parameters

#### UEPADCB

Address of the selectable association data control block. This is mapped by the DFHMNADS DSECT.

#### UEPADCBL

Length, in bytes, of the associated data control block.

#### UEPUCD

Address of a 64-byte output area in which the exit program can place the user correlation data.

## Return codes

## **UERCNORM**

Continue processing.

### **XPI calls**

All can be used.

### **API and SPI calls**

All can be used, except for:

- EXEC CICS ABEND
- EXEC CICS PERFORM SHUTDOWN

## **Sample exit program, DFH\$APAD**

CICS provides a sample global user exit program, DFH\$APAD, for use at the XAPADMGR exit point. The exit program is invoked, if enabled, when non-system tasks for which no input Origin Descriptor Record is provided are attached.

DFH\$APAD performs the following processing:

- Provides addressability to the associated data provided as input to the exit.
- Chooses a field from this data and places it in the output buffer.
- Adds a field to the user correlation data in the output buffer.

### **Related concepts**

“The Application Associated Data sample exit program” on page 18

## **Basic Mapping Support exits XBMIN and XBMOU**

The XBMIN exit allows you to intercept a RECEIVE MAP request after BMS has successfully processed the request. The XBMOU exit allows you to intercept a SEND MAP request after BMS has successfully processed the request; or, if cumulative mapping is in progress, on completion of each page of output.

The XBMIN exit is called, if enabled, when all the following are true:

- A RECEIVE MAP command has been successfully processed.
- The map referenced in the command contains at least one field specified as VALIDN=USEREXIT.
- At least one USEREXIT field has been returned in the inbound datastream and has been mapped into the application data structure.

Using XBMIN, you can:

- Analyze each field defined as VALIDN=USEREXIT mapped to the application on this request
- Use the mapset name, map name, and field length defined in the map, and the actual length of field data returned in the inbound datastream
- Modify the data in each field.

The XBMOU exit is called, if enabled, when all the following are true:

- A SEND MAP command has been successfully processed.
- The map referenced in the command contains at least one field specified as VALIDN=USEREXIT.
- At least one USEREXIT field has been generated in the outbound datastream.

Using XBMOU, you can:

- Analyze each field defined as VALIDN=USEREXIT which has been generated in the outbound datastream



- Use the mapset name, map name, and field length defined in the map, and the actual length of field data placed in the outbound datastream
- Modify the data in each field
- Modify the attributes sent with each field.

Both exits are passed four exit-specific parameters:

1. The address of the TCTTE associated with the mapping request
2. The address of the system EIB associated with the task issuing the mapping request
3. The address of a halfword binary count of the number of elements in the *field element table*
4. The address of the field element table.

## Sample program, DFH\$BMXT

CICS supplies a sample program, DFH\$BMXT, that shows how mapped input and output data can be modified with reference to the information provided in the “field element” table. A copybook, DFHXBMS, is also supplied. This copybook is a DSECT which defines the structure of the field element.

### Related concepts

“The Basic Mapping Support sample exit program” on page 18

## Exit XBMIN

### When invoked

After BMS has successfully processed an input mapping operation.

### Exit-specific parameters

#### UEPBMTCT

Address of the TCTTE associated with the mapping request.

#### UEPEXECB

Address of the system EIB associated with the task.

#### UEPBMCNT

Address of the halfword binary number of “field elements” in the field element table.

#### UEPBMTAB

Address of the field element table.

### Return codes

#### UERCNORM

Continue processing.

#### UERCPURG

Task purged during XPI call.

### XPI calls

All can be used.

## Exit XBMOUT

### When invoked

After BMS has successfully completed a page of output during an output mapping operation.

### Exit-specific parameters

**UEPBMTCT**

Address of the TCTTE associated with the mapping request.

**UEPEXECB**

Address of the system EIB associated with the task.

**UEPBMCNT**

Address of the halfword binary number of “field elements” in the field element table.

**UEPBMTAB**

Address of the field element table.

**Return codes****UERCNORM**

Continue processing.

**UERCPURG**

Task purged during XPI call.

**XPI calls**

All can be used.

**The field element table structure**

The *field element table* contains one or more elements which provide information about each “field of interest” passed to the exit. A “field of interest” is a field which has been defined as VALIDN=USEREXIT in the map source file used to create the mapset referenced in the mapping operation.

Each field element has the following structure:

**BMXMAPST**

is an 8-byte area which contains the name of the mapset associated with this field. If terminal or alternate suffixes are used with mapset names in your CICS installation, the mapset name may have a suffix appended to the name specified in the mapping request.

**BMXMAP**

is a 7-byte area which contains the name of the map associated with this field.

**BMXFDFB**

is a one-byte field copied from the field specification in the map load module. It contains indicators as follows:

**X'80'** CASE=MIXED

**X'40'** Group field entry

**X'20'** Group field descriptor

**X'10'** ATTRB=DET

**X'08'** JUSTIFY=ZERO

**X'04'** JUSTIFY=RIGHT

**X'02'** INITIAL,XINIT, or GINIT specified

**X'01'** Named field (DSECT entry exists)

**BMXMAPLN**

is a halfword binary value which contains the field length defined in the LENGTH option of the DFHMDF macro.

**BMXACTLN**

is a halfword binary value which contains the actual length of the data received or transmitted in this field.

**BMXDATA**

is the address of the field data.

In the XBMIN exit, BMXDATA points into a work area which BMS has obtained for input mapping purposes. When the exit returns control, this work area is copied to the application data structure associated with this map.

In the XBMOU exit, BMXDATA points into a terminal input/output area (TIOA) in which BMS has generated an output datastream. When the exit returns control, the TIOA is disposed of in accordance with the disposition of the TERMINAL (the default), SET, or PAGING option specified on the SEND MAP request.

**BMXATTR**

is only relevant in the XBMOU exit. It is the address of the attributes (if any) which BMS has placed in the output datastream preceding this field.

**BMXMAPOF**

is the offset of the field in the map. For example, if a map is defined as

```
MYMAP DFHMDI SIZE=(12,40)
```

and a field in this map is defined as

```
FLDA DFHMDF POS=(5,1)
```

the offset of this field (relative to zero) is 160 in decimal notation. In this example, BMXMAPOF would contain the value X'00A0'.

**BMXBUF**

is the offset of the field in the device buffer. Usually—that is, when the map dimensions are the same as the current screensize in use by the device—this value will be the same as that of BMXMAPOF. However, using the example given in the BMXMAPOF description above, if MYMAP is sent to a device currently using a 24 by 80 screensize, the offset of the field in the device buffer (again relative to zero) is 320 in decimal notation. In this example, BMXBUF would contain the value X'0140'.

**Programming the XBMIN exit**

This section contains some considerations specific to the XBMIN exit.

The actual data length (in BMXACTLN) may be less than the length defined in the map (in BMXMAPLN). This could happen, for example, if a terminal operator does not completely fill a data entry field. In this case, BMS will have right- or left-justified the data in the field and padded the field with blank or zero characters. This justification and padding occurs before the exit is invoked. Your exit program can, by checking the bit settings in the BMXFDFB field, determine how BMS performed justification and padding for the field.

The actual data length (in BMXACTLN) may be greater than the length defined in the map (in BMXMAPLN). This could happen, for example, if a map contains an unprotected field which is not immediately followed by another field. This allows the terminal operator to enter data past the end of the field. When this occurs, the data field is truncated by BMS according to the length defined for the field in the map. However, BMXACTLN contains the length of data found in the inbound datastream.

When modifying data in the XBMIN exit, the safest method is to use the length provided in BMXMAPLN, but to ensure that any pad characters added by BMS are preserved.

BMXATTR must be ignored in the XBMIN exit; it always contains binary zeroes.

### **Programming the XBMOU exit**

This section contains some considerations specific to the XBMOU exit.

The actual data length (in BMXACTLN) may be less than the length defined in the map (in BMXMAPLN). This occurs due to the compression of trailing nulls performed by BMS for each output field.

The actual length of data cannot be changed in the exit program. The exit is invoked after the output datastream has been generated; consequently, an attempt to alter the data length could result in an invalid datastream. Therefore, if an XBMOU exit program modifies data, it must do so with reference to the length value in BMXACTLN.

BMXDATA may contain a null value. This can be caused by a SEND MAP request with the MAPONLY option when the map has fields without default data; this causes BMS to send an attribute sequence for the field but no data.

BMXATTR may contain a null value. This can be caused by a SEND MAP request with the DATAONLY option, when the application is updating the data in a field and not the attributes.

**Cumulative mapping operations:** When an application is performing cumulative mapping—that is, issuing a sequence of SEND MAP commands with the ACCUM option—BMS builds composite display in which a single page of output might be constructed from multiple SEND MAP requests. When cumulative mapping occurs, the XBMOU exit is called when a page has been built, not as each SEND MAP request is processed.

**Message routing:** When an application builds a routing message—for example, it issues a ROUTE command followed by one or more SEND MAP commands with the SET or PAGING option specified—the XBMOU exit is invoked in the same way as for a non-routed mapping request.

However, the UEPBMTCT parameter is passed as a null value for a routed message. This is because a routed message may be destined for multiple devices, and BMS has optimized the features supported by the devices targeted by the routed message. When processing a routed message in the XBMOU exit, referencing the TCTTE for any of these devices would probably not be relevant.

## **Bridge facility exit XFAINTU**

The bridge facility exit is called just after a new bridge facility has been built and just before the bridge facility is deleted.

The bridge facility might be deleted at the end of a task, when zero keep time is specified, or when a keep time expires before the facility is reused.

### **Exit XFAINTU**

#### **When invoked**

Just after a bridge facility is created and just before it is deleted.

## Exit-specific parameters

### **UEPFAREQ**

Address of a 1-byte field that indicates why the exit has been called. Possible values are:

### **UEPFAIN**

Initialization.

### **UEPFATU**

Tidy-up.

### **UEPFATUT**

Address of a 1-byte field that indicates the type of tidy-up required. Possible values are:

### **UEPFANTU**

Normal tidy-up.

### **UEPFAETU**

Expired tidy-up.

### **UEPFANAM**

Address of the bridge facility name.

### **UEPFATYP**

Address of a 1-byte field that indicates the facility type. The value is always:

### **UEPFABR**

3270 bridge facility.

### **UEPFAUAA**

Address of the bridge facility user area (TCTUA).

### **UEPFAUAL**

Address of a one-byte field containing the length of the bridge facility user area.

### **UEPFATK**

Address of the 8-byte facilitytoken.

### **UEPFAMCH**

Address of a 1-byte field that indicates the mechanism used to start the bridged transaction using this bridge facility. Possible values are:

### **UEPFASTA**

Started using START BREXIT.

### **UEPFALNK**

Started using a link to DFHL3270.

### **UEPFAREG**

Address of a 1-byte field that indicates whether the region owns the bridge facility, or whether it is remote. A bridge facility is owned by the AOR, where it is local, and is remote to the router region. Note that XFAINTU can be called twice in the same region if the AOR and the router are the same region. Possible values are:

### **UEPFAROU**

This region is the router for this bridge facility.

### **UEPFAAOR**

This region is the AOR for this bridge facility.

## **Return codes**

### **UERCNORM**

Continue processing.

## **XPI calls**

All can be used, except those that use recoverable resources.

## **API calls**

All can be used except those that invoke task-related user exits or use recoverable resources.

## **Data tables management exits XDTRD, XDTAD, and XDTLC**

Data tables management exits apply to both CICS shared data tables and CICS coupling facility data tables.

XDTRD and XDTAD allow you to control the selection of records for inclusion in a data table, XDTRD being used to make such selections during loading, and XDTAD being invoked when records are subsequently added to a loaded data table (or to a CFDT that did not require loading). XDTRD also allows the contents of records that are included in a user-maintained table, or a coupling facility data table, to be modified before they are added.

For CICS shared data tables, XDTLC enables you to take action based on the fact that a data table has completed loading, which might be to end some restrictions that you have decided to place on access to the data table during loading, or to cater for an unsuccessful completion of the loading.

For a coupling facility data table, XDTLC allows your global user exit program to decide whether to accept an unsuccessfully loaded coupling facility data table. If the user exit program decides to accept the table, it remains open and available for access, but CICS does not mark it as loading completed. This is also the default action if no XDTLC exit is enabled. This means that application programs continue to receive the LOADING condition for any records that are beyond the key range of records successfully loaded into the table. This ensures that application programs are aware that not all the expected data is available. It also allows you to retry the load, when the cause of the failure has been corrected, by closing the file that initiated the load and reopening it. Alternatively, you could open another load-capable file that refers to the same data table. If your exit program decides to reject the table, it is closed and the records already loaded remain in the table. If the cause of the failure is corrected, a subsequent open for the data table allows the load to complete. XDTLC is not invoked for a coupling facility data table that is not loaded from a source data set.

Note that a program invoked from any of these exit points must declare a DSECT defining the data tables user exit parameter list pointed to by field UEPDTPL. (Although UEPDTPL is defined by a DFHUEXIT call, the parameter list that it addresses is not.) To do this, your program can include the copybook DFHXDTDS, which defines the DT\_UE\_PLIST DSECT.

If any tables specify OPENTIME=STARTUP or are opened implicitly, you should provide a program list table post-initialization (PLTPI) program to activate the user exits. Otherwise, the data table might start loading before the exits can be enabled. For more details about PLTPI programs, see Chapter 4, "Writing initialization and shutdown programs," on page 425.

**Note:** For additional information about using these exits with CICS shared data table support, see the *CICS Shared Data Tables Guide*.

### Related concepts

“The data tables sample exit programs” on page 18

## Exit XDTRD

The XDTRD user exit is invoked just before CICS attempts to add to the data table a record that has been retrieved from the source data set.

This normally occurs when the loading process retrieves a record during the sequential copying of the source data set. However, it can also occur when an application retrieves a record that is not in the data table and:

- For a user-maintained data table, loading is still in progress, or
- For a CICS-maintained data table, loading terminated before the end of the source data set was reached (because, for example, the data table was full).

**Note:** For a coupling facility data table the XDTRD exit is invoked only for a table that is loaded from a source data set.

The record retrieved from the source data set is passed as a parameter to the user exit program—see fields UEPDTRA and UEPDTRL. Your exit program can choose (depending, for example, on the key value—see fields UEPDTKA and UEPDTKL) whether to include the record in the data table or not.

Alternatively, the exit program can request that all subsequent records up to a specified key are skipped—see field UEPDTSKA; these records are not passed to the exit program. This facility is available only during loading. You can specify the key as a complete key, or you can specify just the leading characters by padding the skip-key area with binary zeros.

For a user-maintained data table, the program can also modify the data in the record to reduce the storage needed for the data table. Application programs that use the data table must be aware of any changes made to the record format by the exit program. If the record length is changed, the exit program must set the new length in the parameter list—see field UEPDTRL. The new length must not exceed the data buffer length—see field UEPDTRBL.

### When invoked

Just before CICS tries to add to the data table a record that has been retrieved from the source data set.

### Exit-specific parameters

#### UEPDTPPL

Address of the data table user exit parameter list, which is mapped by DSECT DT\_UE\_PLIST in copybook DFHXDTDS. The data table user exit parameter list contains:

#### UEPDTNAM

The 8-character data table name.

#### UEPDFTLG

A 1-byte flag field. The possible bit settings are:

#### UEPDTSOT (X'80')

The exit has been invoked by CICS shared data table support.

**UEPDCMT (X'40')**

This is a CICS-maintained table. Only meaningful if UEPDTSDT is on.

**UEPDTOPT (X'20')**

The exit has been invoked for table loading. This means that optimization by skipping can be requested.

**UEPDCFT(X'10')**

The exit has been invoked by coupling facility data table support.

**UEPDTUMT (X'08')**

This is a user-maintained table. Only meaningful if UEPDTSDT is on.

**UEPDTRA**

The address of the data record.

**UEPDTRBL**

The fullword length of the data table buffer.

**UEPDTRL**

The fullword length of the data record.

For user-maintained tables, the exit program can set a new length in this field, if it amends the record.

**UEPDTKA**

The address of the data table key.

**UEPDTKL**

The fullword length of the data table key.

**UEPDDSL**

The fullword length of the name of the source data set. Only meaningful if either UEPDTSDT or UEPDCFT is on.

**UEPDTSN**

A 44-character field containing the name of the source data set. Only meaningful if either UEPDTSDT or UEPDCFT is on.

**UEPDTSKA**

The address of a skip-key area. When invoked for table loading, your exit program can return a key of length UEPDTKL in this area, and request load optimization by setting a return code of UERCDCDOP. Only meaningful if either UEPDTSDT or UEPDCFT is on.

**Return codes****UERCDCDOP**

Add the record to the data table.

**UERCDCDTRJ**

Reject the record: that is, do not add it to the table.

**UERCDCDOP**

Skip this and the following records until a key is found that is equal to or greater than the key specified in the skip-key area. Only meaningful if either UEPDTSDT or UEPDCFT is on.



## XPI calls

All can be used.

## Exit XDTAD

The XDTAD user exit is invoked when a write request is issued to a data table.

- For a user-maintained data table and coupling facility data table, the user exit is invoked once—before the record is added to the data table.
- For a CICS-maintained data table, the user exit is invoked twice—before the record is added to the source data set and then again before the record is added to the data table.

The record written by the application is passed as a parameter to the user exit program—see fields UEPDTRA and UEPDTRL. Your exit program can choose (depending on the key value, for example—see fields UEPDTKA and UEPDTKL) whether to include the record in the data table or not. This decision is indicated by setting the return code.

The XDTAD exit must not modify the data in the record. If you used XDTRD to truncate the data records when the data table was loaded, you must code your application so that it only tries to write records of the correct format for the data table.

A sample XDTAD exit program is listed in the *CICS Shared Data Tables Guide*.

### When invoked

One or more times during the processing of a write request to a data table.

### Exit-specific parameters

#### UEPDTPPL

Address of the data table user exit parameter list, which is mapped by DSECT DT\_UE\_PLIST in copybook DFHXDTDS. The data table user exit parameter list contains:

#### UEPDTNAM

The 8-character data table name.

#### UEPDFTLG

A 1-byte flag field. The possible bit settings are:

#### UEPDTSMT (X'80')

The exit has been invoked by CICS shared data table support.

#### UEPDTCMT (X'40')

This is a CICS-maintained table. Only meaningful if UEPDTSMT is on.

#### UEPDTCFT(X'10')

The exit has been invoked by coupling facility data table support.

#### UEPDUMT (X'08')

This is a user-maintained table. Only meaningful if UEPDTSMT is on.

#### UEPDTRA

The address of the data record.

**UEPDTRBL**

The fullword length of the data table buffer.

**UEPDTRL**

The fullword length of the data record.

**UEPDTKA**

The address of the data table key.

**UEPDTKL**

The fullword length of the data table key.

**UEPDTDSL**

The fullword length of the name of the source data set.  
Only meaningful if either UEPDTSDT or UEPDTCFT is on.

**UEPDTDSN**

A 44-character field containing the name of the source data set. Only meaningful if either UEPDTSDT or UEPDTCFT is on.

**Return codes****UERC DTAC**

Add the record to the data table.

**UERC DTRJ**

Reject the record: that is, do not add it to the table.

**XPI calls**

All can be used.

**Exit XDTLC**

The XDTLC user exit is invoked at the completion of data table loading—whether successful or not. **The user exit is not invoked if the data table is closed for any reason before loading is complete.** The XDTLC exit is invoked for a coupling facility data table only if the table is loaded from a source data set.

The exit program is informed if the loading did not complete successfully—see field UEPDTORC. This could occur, for example, if the maximum number of records was reached or there was insufficient virtual storage. In this case, the exit program can request that the file is closed immediately, by setting the return code.

**When invoked**

At the completion of table loading. It is not invoked if the loading process was terminated because the data table had been closed.

**Exit-specific parameters****UEPD TPL**

Address of the data table user exit parameter list, which is mapped by DSECT DT\_UE\_PLIST in copybook DFHXDTDS. The data table user exit parameter list contains:

**UEPD TNAM**

The 8-character data table name.

**UEPD TFLG**

A 1-byte flag field. The possible bit settings are:

**UEPD TSDT (X'80')**

The exit has been invoked by CICS shared data table support.

**UEPDTCMT (X'40')**

This is a CICS-maintained table. Only meaningful if UEPDTSDT is on.

**UEPDTCFT(X'10')**

The exit has been invoked by coupling facility data table support.

**UEPDTUMT (X'08')**

This is a user-maintained table. Only meaningful if UEPDTSDT is on.

**UEPDTORC**

Data table open result code. The possible values are:

**UEPDTLCS**

Load successful

**UEPDTLFL**

Load unsuccessful.

**UEPDTDSL**

The fullword length of the name of the source data set. Only meaningful if either UEPDTSDT or UEPDTCFT is on.

**UEPDTDSN**

A 44-character field containing the name of the source data set. Only meaningful if either UEPDTSDT or UEPDTCFT is on.

**Return codes****UERCDTOK**

Accept the data table in its present state

**UERC DTCL**

Close the data table.

**XPI calls**

All can be used.

**DBCTL interface control program exit XXDFA****When invoked**

By an active CICS when its connection to DBCTL fails. Your exit program is invoked after the active CICS has informed the alternate CICS of the failure.

**Exit-specific parameters****UEPDBXR**

Address of CICS XRF information for use with DBCTL. The CICS XRF information can be mapped using the DSECT DFHDXUEP.

**Return codes****UERCNOAC**

Take no action.

**UERC SWCH**

Switch to the alternate DBCTL.

**UERCABNO**

Abend CICS without a dump.

## **UERCABDU**

Abend CICS with a dump.

### **XPI calls**

TRANSACTION\_DUMP must not be used.

## **DBCTL tracking program exits XXDFB and XXDTO**

### **Exit XXDFB**

#### **When invoked**

By the alternate CICS when it receives a message from the active CICS indicating that connection to DBCTL has failed. The alternate and active CICS systems are running in different MVS images, perhaps in different central processing complexes (CPCs). More information about these exits is provided in the *CICS IMS Database Control Guide*.

#### **Exit-specific parameters**

##### **UEPDBXR**

Address of CICS XRF information for use with DBCTL. The CICS XRF information can be mapped using the DSECT DFHDXUEP.

#### **Return codes**

##### **UERCNOAC**

Take no action.

##### **UERC SWCH**

Switch to the alternate DBCTL.

##### **UERCABNO**

Abend CICS without a dump.

##### **UERCABDU**

Abend CICS with a dump.

The return code 'UERCNORM' is not available for use at this exit point.

### **XPI calls**

The following must not be used:

- INQUIRE\_MONITORING\_DATA
- MONITOR
- TRANSACTION\_DUMP
- WRITE\_JOURNAL\_DATA.

### **Exit XXDTO**

#### **When invoked**

By an alternate CICS when it performs takeover under the following conditions:

- The active and alternate CICS systems are in different MVS images, perhaps in different processors.
- The active CICS was connected to, or trying to connect to, a DBCTL subsystem. (This does not include disconnecting from one DBCTL and reconnecting to another.)
- The takeover was not initiated by the XXDFB exit, or the takeover was initiated by XXDFB but the active system reestablished a DBCTL connection before takeover occurred and XXDTO was driven for a new DBCTL takeover decision.

### Exit-specific parameters

#### UEPDBXR

Address of CICS XRF information for use with DBCTL. The CICS XRF information can be mapped using the DSECT DFHDXUEP.

### Return codes

#### UERCNOAC

Take no action.

#### UERCWCH

Switch to the alternate DBCTL.

#### UERCABNO

Abend CICS without a dump.

#### UERCABDU

Abend CICS with a dump.

The return code UERCNORM is not available for use at this exit point.

### XPI calls

The following must not be used:

- INQUIRE\_MONITORING\_DATA
- MONITOR
- TRANSACTION\_DUMP
- WRITE\_JOURNAL\_DATA.

## Dispatcher domain exits XDSBWT and XDSAWT

The XDSBWT and XDSAWT exit points are located before and after the operating system wait. CICS services **cannot** be used in any exit program invoked from these exit points.

The XDSBWT and XDSAWT exits can be used to control the swapping state of the CICS address-space. It should be noted, however, that if the default state of the address-space is non-swappable then these exits cannot be used to override this state.

CICS uses a counter which is incremented for every SYSEVENT DONTSWAP request and decremented for every SYSEVENT OKSWAP request down to a minimum of 0. A SYSEVENT DONTSWAP request is issued when this counter goes up from 0 to 1. A SYSEVENT OKSWAP request is issued when this counter goes down from 1 to 0. In all other circumstances, the SYSEVENT is not issued.

### Exit XDSBWT

#### When invoked

Before an operating system wait issued by the quasireentrant CICS TCB.

#### Exit-specific parameters

None.

#### Return codes

##### UERCNORM

Continue processing.

##### UERCWAP

Issue SYSEVENT to allow address-space swapping.

**XPI calls**

Must not be used.

**Exit XDSAWT****When invoked**

After an operating system wait issued by the quaireentrant CICS TCB.

**Exit-specific parameters****UEPSYSRC**

Address of the 4-byte return code from the SYSEVENT request made before the operating system wait. This return code will be in one of two different forms:

1. The SYSEVENT OKSWAP return code, or
2. If the SYSEVENT request was rejected by CICS, a special CICS return code which will take one of the following decimal values:

**17** The SYSEVENT OKSWAP was not issued. The outstanding count of SYSEVENT OKSWAP requests exceeds the count of SYSEVENT DONTSWAP requests. Before a SYSEVENT OKSWAP can be issued, a SYSEVENT DONTSWAP must be requested.

**19** The SYSEVENT OKSWAP was not issued. The outstanding count of SYSEVENT DONTSWAP requests still exceeds the count of SYSEVENT OKSWAPs. Further SYSEVENT OKSWAPs must be requested before a SYSEVENT OKSWAP is issued by CICS.

**Return codes****UERCNORM**

Continue processing.

**UERCNOSW**

Issue SYSEVENT to suppress address-space swapping.

**XPI calls**

Must not be used.

**DL/I interface program exits XDLIPRE and XDLIPOST**

The XDLIPRE and XDLIPOST exit points are invoked following the issue of an EXEC DLI command or DL/I call. Exit XDLIPRE is invoked before the request is processed and XDLIPOST is invoked after the request is processed.

When the request is function shipped, the exits are invoked from both the application-owning region and the database-owning region. However, there are restrictions when they are invoked in a database-owning region, as described below.

The *CICS IMS Database Control Guide* contains a sample program for the XDLIPRE exit.

**Note:**

1. The descriptions of the exits that follow show the general format of the application's parameter list. For detailed information about the format of the CALL-level DL/I parameter list, refer to the *IMS/ESA® Application Programming: DL/I Calls* manual.
2. For all EXEC DLI calls, the application's parameter list is in assembler-language format (that is, the value of the program language byte pointed to by UEPLANG is always UEPASM, and the parameter list pointed to by UEPALIST is always in assembler-language format). This is because all EXEC DLI calls are converted into assembler-language CALL-level requests.

An EXEC DLI online request is converted by DFHEDP into a CALL-level request for DFHDLI. (IMS™ does not deal directly with EXEC-level parameter lists.)

The first parameter in the CALL parameter list contains the address of the parameter count.

The second parameter in the CALL parameter list contains the address of the function. All other parameters are dependent on the function.

3. In an XDLIPRE exit program you can change the PSB name and the SYSID name. This helps availability if the originally specified SYSID fails.

You can change the SYSID from:

- A remote value to another remote value
- The local value to a remote value
- A remote value to the local value.

Changing the SYSID has an effect only if the associated PSB has a PDIR entry. The SYSID may be the local CICS (that is, the SYSIDNT specified on the CICS region) or a remote connection name. For the new SYSID to be used, the PSB name must have a PDIR entry; if it does not have a PDIR entry, the assumption is made that the local CICS is connected to DBCTL, and an attempt is made to run the IMS request there. An IMS schedule failure is handled in the same way as a failure to route to a connection that does not exist. If the SYSID is changed to either the same value as the SYSIDNT of the local CICS or blanks (hex '40404040'), CICS attempts to run the IMS request on the local system.

## Exit XDLIPRE

### When invoked

On entry to the DL/I interface program.

### Exit-specific parameters

#### UEPCTYPE

Address of type-of-request byte. Values are:

#### UEPCEXEC

The original request was an EXEC DLI request.

#### UEPCCALL

The original request was a CALL-level request.

#### UEPCSHIP

The request has been function shipped from another region. When this value is set, restrictions apply to the setting and use of the rest of the exit parameters, as described below.

## UEPAPLIST

Address of application's parameter list. The general format for COBOL and assembler language is:

```
plist address --> parm1 address --> parm1
                parm2 address --> parm2
                parm3 address --> parm3
                .....
                up to a maximum of 18 parameters
                excluding the optional parmcount.
```

The general format for PL/I is:

```
plist address --> parm1 address --> parm1 (parmcount)
                parm2 address --> locator descriptor --> parm2
                parm3 address --> locator descriptor --> parm3
                .....
                up to a maximum of 18 parameters
```

When UEPCTYPE is not UEPCSHIP, your exit program can change any of the parameters in the application parameter list. For UEPCSHIP requests, your exit program **cannot** change any of the parameters. Furthermore, for UEPCSHIP requests, UEPAPLIST points to a copy of the parameter list in the above format, but which contains only the first two parameters, parm1 and parm2.

**Note:** For PL/I applications, parm1 may or may not contain a parameter-count. Your exit program should check this field before using it.

## UEPLANG

Address of program language byte. Values are:

### UEPPLI

PL/I

### UEPCBL

COBOL

### UEPASM

Assembler language.

For UEPCSHIP requests, the language is always assembler.

## UEPIOAX

Address of I/O area existence flag byte:

### UEPIOA1

I/O area exists.

For UEPCSHIP requests, the I/O area existence flag is always off.

## UEPIOA

Address of I/O area. This is the application's IOAREA, or DFHEDP's IOAREA in the case of EXEC DLI. The contents of the IOAREA can be overwritten in the exit: the new contents are used when the DL/I request is processed. However, it should be noted that IOAREAs can be in a program's static storage and, in this case, should not be overwritten.

For UEPCSHIP requests, UEPIOA is always zero.

## UEPPSBNX

Address of PSB existence flag byte:



**UEPPSB1**

A PSB exists.

**UEPPSBNM**

Address of an area containing the 8-character PSB name. The contents of the area can be overwritten by the exit, for all types of request including UEPCSHIP; the new contents are used when the DL/I request is processed.

**UEPSYSDX**

Address of the SYSID existence flag byte:

**UEPSYS1**

A SYSID exists.

**UEPSYSID**

Address of an area containing the 4-character SYSID name. The contents of the area can be overwritten by the exit, for all types of request including UEPCSHIP; the new contents are used when the DL/I request is processed.

**Return codes****UERCNORM**

Continue processing

**UERCBYP**

Bypass DL/I request and return

**UERPURG**

Task purged during XPI call.

**XPI calls**

All can be used.

**Exit XDLIPOST****When invoked**

On exit from the DL/I interface program.

**Exit-specific parameters****UEPCTYPE**

Address of type-of-request byte. Values are:

**UEPCEXEC**

An EXEC DLI request.

**UEPCCALL**

A CALL-level request.

**UEPCSHIP**

The request has been function shipped from another region. When this value is set, restrictions apply to the setting and use of the rest of the exit parameters, as described below.

**UEPAPLIST**

Address of application's parameter list. The general format for COBOL and assembler language is:

```
plist address --> parm1 address --> parm1
                    parm2 address --> parm2
                    parm3 address --> parm3
                    .....
                    up to a maximum of 18 parameters
                    excluding the optional parmcount.
```

The general format for PL/I is:

```
plist address --> parm1 address --> parm1 (parmcount)
      parm2 address --> locator descriptor --> parm2
      parm3 address --> locator descriptor --> parm3
      .....
      up to a maximum of 18 parameters.
```

When UEPCTYPE is not UEPCSHIP, your exit program can change any of the parameters in the application parameter list. For UEPCSHIP requests, your exit program **cannot** change any of the parameters. Furthermore, for UEPCSHIP requests, UEPAPLIST points to a copy of the parameter list in the above format, but which contains only the first two parameters parm1 and parm2. See also Notes.

**Note:** For PL/I applications, parm1 may or may not contain a parameter-count. Your exit program should check this field before using it.

#### **UEPLANG**

Address of program language byte. Its values are:

##### **UEPPLI**

PL/I

##### **UEPCBL**

COBOL

##### **UEPASM**

Assembler language.

For UEPCSHIP requests, the language is always assembler.

#### **UEPIOAX**

Address of I/O area existence flag byte:

##### **UEPIOA1**

I/O area exists.

For UEPCSHIP requests, the I/O area existence flag is always off.

#### **UEPIOA**

Address of I/O area. This is the application's IOAREA, or DFHEDP's IOAREA in the case of EXEC DLI. The contents of the IOAREA can be overwritten in the exit and are returned to the application program in the new form. However, it should be noted that the application's IOAREA could be in the program's static storage and, in this case, should not be overwritten.

For UEPCSHIP requests, UEPIOA is always zero.

#### **UEPUIBX**

Address of UIB existence flag byte:

##### **UEPUIB1**

a UIB exists.

#### **UEPUIB**

Address of the UIB, which is mapped by DFHUIB in module DFHDBCOP. The contents of the UIB can be overwritten in the exit for all types of request, including UEPCSHIP. The new contents are returned to the application or to the region that function shipped the request.

## Return codes

### UERCNORM

Continue processing.

### UERPURG

Task purged during XPI call.

## XPI calls

All can be used.

## Dump domain exits XDUREQ, XDUREQC, XDUCLESE, and XDUOUT

There are four exits in the dump domain.

### Related concepts

“The dump domain sample exit program” on page 19

### Exit XDUREQ

#### When invoked

Immediately before a system or transaction dump is taken.

#### Exit-specific parameters

##### UEPTRANID

Address of the 4-byte transaction ID.

##### UEPUSER

Address of the 8-byte user ID.

##### UEPTERM

Address of the 4-byte terminal ID.

##### UEPPROG

Address of the 8-byte application program name, or nulls if there is no current application.

##### UEPDUMPC

Address of copy of the 8-byte dump code.

##### UEPABCDE

Address of a copy of the 8-byte Kernel error code in the format xxx/yyyy. xxx denotes the 3-digit hexadecimal MVS completion code (for example 0C1 or D37). If an MVS completion code is not applicable, xxx is three hyphens. The 4-digit code yyyy is a user abend code produced either by CICS or by another product on your system. UEPABCDE is completed only for abend codes corresponding to the following dump codes:

- AP0001
- SR0001
- ASRA
- ASRB
- ASRD

Otherwise this field contains null characters.

##### UEPDUMPT

Address of the 1-byte dump-type identifier, which contains one of the following values:

##### UEPDTRAN

A transaction dump was requested.

**UEPDSYST**

A system dump was requested.

**Note:** The dump-type identifier indicates the type of dump request that was passed to the dump domain. It does not reflect any modification that may have been made to the original request by a user entry in the dump table.

**UEPXDSCP**

Address of a 1-byte field indicating the current dump table DUMPSCOPE setting. It contains one of the following values:

**UEPXDLOC**

A system dump will be taken on the local MVS image only.

**UEPXDREL**

System dumps will be taken on both the local MVS image, and on related MVS images within the sysplex.

This field may be modified by the exit to update the dump table DUMPSCOPE setting.

**UEPXDTXN**

Address of a 1-byte field indicating the current dump table TRANDUMP setting. It contains one of the following values:

**UEPXDYES**

A transaction dump will be taken.

**UEPXDNO**

A transaction dump will not be taken.

This field may be modified by the exit to update the dump table TRANDUMP setting.

**Note:** This field is only valid if UEPDUMPT contains the value UEPDTRAN.

**UEPXDSYS**

Address of a 1-byte field indicating the current dump table SYSDUMP setting. It contains one of the following values:

**UEPXDYES**

A system dump will be taken.

**UEPXDNO**

A system dump will not be taken.

This field may be modified by the exit to update the dump table SYSDUMP setting.

**UEPXDTRM**

Address of a 1-byte field indicating the current dump table SHUTDOWN setting. It contains one of the following values:

**UEPXDYES**

The CICS system is to shutdown.

**UEPXDNO**

The CICS system is not to shutdown.

This field may be modified by the exit to update the dump table SHUTDOWN setting.

**UEPXDMAX**

Address of a 4-byte field which contains the current dump table **MAXIMUM** setting. This field may be modified by the exit to change the current dump table **MAXIMUM** setting. A change to the **MAXIMUM** setting will not suppress this dump request. A return code of **UERCBYP** may be used to suppress the current dump request.

**UEPDXCNT**

Address of a 4-byte field which contains the current dump table **CURRENT** setting.

**UEPXDST**

Address of a 16-byte field which contains the current dump table statistics for this dump code. The addressed field consists of four 4-byte fields containing binary integers:

- Number of transaction dumps taken
- Number of transaction dumps suppressed
- Number of system dumps taken
- Number of system dumps suppressed

**Note:** Statistics for transaction dumps are valid only if **UEPDUMPT** contains the value **UEPDTRAN**.

**UEPXDDAE**

Address of a 1-byte field which represents the current dump table **DAEOPTION** setting. It contains one of the following values:

**UEPXDYES**

The dump is eligible for DAE suppression.

**UEPXDNO**

The dump will not be suppressed by DAE.

This field may be modified by the exit to update the dump table **DAEOPTION** setting.

**UEPDMPID**

Address of a 9-character field in the format **xxxx/xxxx**, containing the dump identifier. The dump ID is the same as that output by the corresponding dump message.

**UEPFMOD**

Address of an 8-byte area containing, if the dump code is **AP0001**, the name of the failing module; otherwise null characters.

Note that field **UEPPROG** always addresses the name of the *current* application, regardless of where the failure occurred. **UEPFMOD** addresses the name of the module where the failure occurred, if known.

If the dump code is **AP0001**, there are three possibilities:

1. The field addressed by **UEPFMOD** contains the same name as the field addressed by **UEPPROG**—the failure occurred in application code.
2. The field addressed by **UEPFMOD** contains a different name from the field addressed by **UEPPROG**—the failure occurred in non-application code.

3. The field addressed by UEPFMODE contains '????????'—the failure was not in application code, but CICS was unable to determine the name of the failing module.

#### Return codes

##### **UERCNORM**

Continue processing.

##### **UERCBYD**

Suppress dump.

##### **UERCPURG**

Task purged during XPI call.

#### XPI calls

WAIT\_MVS can be used **only** when a UEPDUMPT indicates that a transaction dump is being taken. **Do not use any other calls.**

#### Related concepts

“The dump domain sample exit program” on page 19

#### Exit XDUREQC

##### When invoked

Immediately after a system or transaction dump has been taken (or has failed or been suppressed).

##### Exit-specific parameters

##### **UEPTRANID**

Address of the 4-byte transaction ID.

##### **UEPUSER**

Address of the 8-byte user ID.

##### **UEPTERM**

Address of the 4-byte terminal ID.

##### **UEPPROG**

Address of the 8-byte application program name.

##### **UEPDUMPC**

Address of copy of the 8-byte dump code.

##### **UEPABCDE**

Address of a copy of the 8-byte Kernel error code in the format xxx/yyyy. xxx denotes the 3-digit hexadecimal MVS completion code (for example X'0C1' or X'D37'). If an MVS completion code is not applicable, xxx is three hyphens. The 4-digit code yyyy is a user abend code produced either by CICS or by another product on your system. UEPABCDE is completed only for abend codes corresponding to the following dump codes:

- AP0001
- SR0001
- ASRA
- ASRB
- ASRD

Otherwise this field contains null characters.

**UEPDUMPT**

Address of the 1-byte dump-type identifier, which contains one of the following values:

**UEPDTRAN**

A transaction dump was requested.

**UEPDSYST**

A system dump was requested.

**Note:** The dump-type identifier indicates the type of dump request that was passed to the dump domain. It does not reflect any modification that may have been made to the original request by a user entry in the dump table.

**UEPXDSCP**

Address of a 1-byte field indicating the current dump table DUMPSCOPE setting. It contains one of the following values:

**UEPXDLOC**

A system dump will be taken on the local MVS image only.

**UEPXDREL**

System dumps will be taken on both the local MVS image, and on related MVS images within the sysplex.

This field may be modified by the exit to update the dump table DUMPSCOPE setting.

**UEPXDTXN**

Address of a 1-byte field indicating the current dump table TRANDUMP setting. It contains one of the following values:

**UEPXDYES**

A transaction dump will be taken.

**UEPXDNO**

A transaction dump will not be taken.

This field may be modified by the exit to update the dump table TRANDUMP setting.

**Note:** This field is only valid if UEPDUMPT contains the value UEPDTRAN.

**UEPXDSYS**

Address of a 1-byte field indicating the current dump table SYSDUMP setting. It contains one of the following values:

**UEPXDYES**

A system dump will be taken.

**UEPXDNO**

A system dump will not be taken.

This field may be modified by the exit to update the dump table SYSDUMP setting.

**UEPXDTRM**

Address of a 1-byte field indicating the current dump table SHUTDOWN setting. It contains one of the following values:

**UEPXDYES**

The CICS system is to shutdown.

**UEPXDNO**

The CICS system is not to shutdown.

This field may be modified by the exit to update the dump table SHUTDOWN setting.

**UEPXDMAX**

Address of a 4-byte field which contains the current dump table MAXIMUM setting. This field may be modified by the exit to change the current dump table MAXIMUM setting.

**UEPDXDCNT**

Address of a 4-byte field which contains the current dump table CURRENT setting.

**UEPXDST**

Address of a 16-byte field which contains the current dump table statistics for this dumpcode. The addressed field consists of four 4-byte fields containing binary integers:

- Number of transaction dumps taken
- Number of transaction dumps suppressed
- Number of system dumps taken
- Number of system dumps suppressed.

**Note:** Statistics for transactions dumps are valid only if UEPDUMPT contains the value UEPDTRAN.

**UEPXDDAE**

Address of a 1-byte field which represents the current dump table DAEOPTION setting. It contains one of the following values:

**UEPXDYES**

The dump was suppressed by DAE.

**UEPXDNO**

The dump was not suppressed by DAE.

This field may be modified by the exit to update the dump table DAEOPTION setting.

**UEPDMPID**

Address of a 9-character field in the format xxxx/xxxx, containing the dump identifier. The dump ID is the same as that output by the corresponding dump message.

**UEPDRESP**

Address of the 2-byte dump response code.

**UEPDREAS**

Address of the 2-byte dump reason code.

**Return codes****UERCNORM**

Continue processing.

**XPI calls**

WAIT\_MVS can be used only when a UEPDUMPT indicates that a transaction dump is being taken. Do not use any other calls.



## Exit XDUCLSE

### When invoked

Immediately after a transaction dump data set has been closed.

### Exit-specific parameters

#### UEPTRANID

Address of the 4-byte transaction ID.

#### UEPUSER

Address of the 8-byte user ID.

#### UEPTERM

Address of the 4-byte terminal ID.

#### UEPPROG

Address of the 8-byte application program name.

#### UEPDMPDD

Address of the 8-byte dump data set ddname.

#### UEPDMPDSN

Address of the 44-byte dump data set dsname.

### Return codes

#### UERCNORM

Continue processing.

#### UERCWCH

The autoswitch flag is set on.

### XPI calls

WAIT\_MVS can be used. **Do not use any other calls.**

## Exit XDUOUT

### When invoked

Before a record is written to the transaction dump data set.

### Exit-specific parameters

#### UEPTRANID

Address of the 4-byte transaction ID.

#### UEPUSER

Address of the 8-byte user ID.

#### UEPTERM

Address of the 4-byte terminal ID.

#### UEPPROG

Address of the 8-byte application program name.

#### UEPDMPFC

Address of the 1-byte function code. The equated values are:

#### UEPDMPWR

Buffer is about to be written.

#### UEPDMPRE

Dump is about to restart after autoswitch.

#### UEPDMPAB

Abnormal termination of dump.

**UEPDMPDY**

Buffer is about to be written, and the CICS dump data set is a dummy file or is closed.

**UEPDMPBF**

Address of the dump buffer, whose length is addressed by the parameter UEPDMPLEN.

**UEPDMPLEN**

Address of the 2-byte dump-buffer length.

**Return codes****UERCNORM**

Continue processing.

**UERCBYD**

Suppress dump record output.

**XPI calls**

WAIT\_MVS can be used. **Do not use any other calls.**

## Enqueue EXEC interface program exits XNQEREQ and XNQEREQC

The XNQEREQ exit allows you to intercept enqueue API requests before any action has been taken on the request. The XNQEREQC exit allows you to intercept the response after an enqueue API request has completed.

The API requests affected are:

- EXEC CICS ENQ
- EXEC CICS DEQ.

Using XNQEREQ, you can:

- Analyze the API parameter list (function, keywords, argument values, and responses).
- Modify any input parameter value prior to execution of a request.
- Prevent execution of a request. This enables you to replace the CICS function with your own processing.

Using XNQEREQC, you can analyze the API parameter list.

You can also:

- Pass data between your XNQEREQ and XNQEREQC exit programs when they are invoked for the same request
- Pass data between your enqueue exit programs when they are invoked within the same task.

### Exit XNQEREQ

**When invoked**

Before CICS processes an EXEC CICS ENQ or DEQ request, or attempts to match it to an installed ENQMODEL resource definition.

**Exit-specific parameters****UEPCLPS**

Address of a copy of the command parameter list. See “The command-level parameter structure” on page 63.

**UEPNQTOK**

Address of a 4-byte area which can be used to pass information between XNQEREQ and XNQEREQC for a single enqueue request.

**UEPRCODE**

Address of a 6-byte hexadecimal copy of the EIB return code EIBRCODE. For details of EIB return codes, see EIB fields, in the *CICS Application Programming Reference* manual.

**UEPRES**

Address of a 4-byte binary copy of the EIB response code EIBRESP.

**UEPRES2**

Address of a 4-byte binary copy of the EIB response code EIBRESP2.

**UEPTSTOK**

Address of a 4-byte token which can be used to pass information between successive enqueue requests within the same task (for example, between successive invocations of the XNQEREQ exit).

**UEPRECUR**

Address of a halfword recursion counter. The counter is set to 0 when the exit is first invoked, and is incremented for each recursive call.

**UEPSCOPE**

Address of the 4-byte ENQSCOPE name to be used.

**Return codes****UERCBYP**

Bypass this request.

**UERCNORM**

Continue processing.

**UEPCPURG**

Task purged during XPI call.

**UERCSCPE**

An ENQSCOPE name has been supplied.

**XPI calls**

All can be used.

**API and SPI commands**

All can be used, except for:  
EXEC CICS SHUTDOWN  
EXEC CICS XCTL

**Note:** Take care when issuing recursive commands. For example, you must avoid entering a loop when issuing an enqueue request from the XNQEREQ exit. Use of the recursion counter UEPRECUR is recommended.

**Exit XNQEREQC****When invoked**

After an enqueue API request has completed, before return from the enqueue EXEC interface program.

**Exit-specific parameters**

**UEPCLPS**

Address of a copy of the command parameter list. See “The command-level parameter structure” on page 63.

**UEPNQTOK**

Address of a 4-byte area which can be used to pass information between XNQEREQ and XNQEREQC for a single enqueue request.

**UEPRCODE**

Address of a 6-byte hexadecimal copy of the EIB return code EIBRCODE. For details of EIB return codes, see EIB fields, in the *CICS Application Programming Reference* manual.

**UEPRES**

Address of a 4-byte binary copy of the EIB response code EIBRESP.

**UEPRES2**

Address of a 4-byte binary copy of the EIB response code EIBRESP2.

**UEPTSTOK**

Address of a 4-byte token which can be used to pass information between successive enqueue requests within the same task (for example, between successive invocations of the XNQEREQC exit).

**UEPRECUR**

Address of a halfword recursion counter. The counter is set to 0 when the exit is first invoked, and is incremented for each recursive call.

**UEPSCOPE**

Address of the 4-byte ENQSCOPE name used.

**Return codes****UERCNORM**

Continue processing.

**UERCPURG**

Task purged during XPI call.

**XPI calls**

All can be used.

**API and SPI commands**

All can be used, except for:

EXEC CICS SHUTDOWN  
EXEC CICS XCTL

You can update the copies of EIBRCODE, EIBRESP, and EIBRESP2 that you are given in the parameter list. If you update the values, CICS copies the new values into the application program's EIB after the completion of XNQEREQC or if you specify a return code of UERCBYP in XNQEREQ.

You must set valid enqueue responses. You must set all three of EIBRCODE, EIBRESP, and EIBRESP2 to a consistent set of values, such as would be set by the enqueue domain to describe a valid completion. CICS does not check the consistency of EIBRCODE, EIBRESP, and EIBRESP2. If EIBRCODE is set to a non-zero value and EIBRESP is set to zero, CICS will override EIBRESP with a

non-zero value. To help you set values for EIBRCODE, EIBRESP, and EIBRESP2, the values used by the enqueue domain are specified in DSECT DFHNQUED.

**Note:** Take care when issuing recursive commands not to cause a loop. For example, it is your responsibility to avoid entering a loop when issuing an enqueue request from the XNQEREQC exit. Use of the recursion counter UEPRECUR is recommended.

## The command-level parameter structure

The command-level parameter structure consists of a series of addresses. The first address points to the EXEC interface descriptor (EID), which consists of a bit string that describes the type of request and identifies each keyword specified with the request. The remaining addresses point to pieces of data associated with the request.

You can examine the EID to determine the type of request and the keywords specified. You can examine the other parameters in the list to determine the values of the keywords. You can also modify values of keywords specified on the request.

## End of parameter list indicator

The high-order bit is set on in the last address set in the parameter list to indicate that it is the last one in the list. On return from your user exit program, CICS scans the parameter list for the high-order bit to find the last parameter. Therefore, if you modify the length of the parameter list, you must also reset the high-order bit to indicate which is the new last address.

### *The UEPCLPS exit-specific parameter:*

The UEPCLPS exit-specific parameter is included in both exit XNQEREQ and exit XNQEREQC. It is the address of the command-level parameter structure. The command-level parameter structure contains four addresses, NQ\_ADDR0 through NQ\_ADDR3. It is defined in the DSECT NQ\_ADDR\_LIST, which you should copy into your exit program by including the statement COPY DFHNQUED.

The command-level parameter list is made up as follows.

**Note:** The relationship between arguments, keywords, data types, and input/output types is summarized for the enqueue commands in Table 3 on page 65.

### **NQ\_ADDR0**

is the address of a 9-byte area called the EID, which is made up as follows:

- **NQ\_GROUP**
- **NQ\_FUNCT**
- **NQ\_BITS1**
- **NQ\_BITS2**
- **NQ\_EIDOPT5**
- **NQ\_EIDOPT6**
- **NQ\_EIDOPT7**
- **NQ\_EIDOPT8**

### **NQ\_GROUP**

Always X'12', indicating that this is a task control request.

## **NQ\_FUNCT**

One byte that defines the type of request:

**X'04'** ENQ

**X'06'** DEQ

## **NQ\_BITS1**

Existence bits that define which arguments were specified. To obtain the argument associated with a keyword, you need to use the appropriate address from the command-level parameter structure. Before using this address, you must check the associated existence bit. If the existence bit is set off, the argument was not specified in the request and the address should not be used.

**X'80'** Set if the request contains an argument for the RESOURCE keyword. If set, **NQ\_ADDR1** is meaningful.

**X'40'** Set if the request contains an argument for the LENGTH keyword. If set, **NQ\_ADDR2** is meaningful.

**X'20'** Set if the request contains an argument for the MAXLIFETIME keyword. If set, **NQ\_ADDR3** is meaningful.

## **NQ\_BITS2**

Two bytes not used by the enqueue domain.

## **NQ\_EIDOPT5**

One byte not used by the enqueue domain.

## **NQ\_EIDOPT6**

One byte not used by the enqueue domain.

## **NQ\_EIDOPT7**

One byte not used by the enqueue domain.

## **NQ\_EIDOPT8**

Indicates whether certain keywords were specified on the request.

**X'04'** NOSUSPEND was specified.

**X'02'** DEQ was specified.

**X'01'** ENQ was specified.

## **NQ\_ADDR1**

is the address of an area containing the value from RESOURCE.

## **NQ\_ADDR2**

is the address of the halfword value of LENGTH.

## **NQ\_ADDR3**

is the address of the fullword value of MAXLIFETIME.

**Modifying fields in the command-level parameter structure:** The fields that are passed to the enqueue domain are used as input to the request. The correct method of modifying an input field is to create a new copy of it, and to change the address in the command-level parameter list to point to your new data.

### **Note:**

1. You must never modify an input field by altering the data that is pointed to by the command-level parameter list. To do so would corrupt storage belonging to the application program and would cause a failure when the program attempted to reuse the field.

2. There are no output fields on EXEC CICS ENQ and DEQ requests.

**Modifying the EID:** It is not possible to modify the EID to make major changes to requests. It is not possible, for example, to change an ENQ request to a DEQ request. However, you can make minor changes to requests, such as to turn on the existence bit for LENGTH. The list that follows shows the bits in the EID that can be modified. Any attempt to modify any other part of the EID is ignored.

**NQ\_BITS1**

- X'40'** The existence bit for LENGTH
- X'20'** The existence bit for MAXLIFETIME.

**NQ\_EIDOPT7**

A user exit program at XNQEREQ can set the following on or off for ENQ commands:

- X'04'** The existence bit for NOSUSPEND.

The EID is reset to its original value before return to the application program. That is, changes made to the EID are retained for the duration of the enqueue request only.

**Note:** Your user exit program is prevented from making major changes to the EID. However, you must take great care when making the minor modifications that **are** permitted.

**Use of the task token UEPTSTOK:** UEPTSTOK provides the address of a 4-byte area that you can use to pass information between successive enqueue requests in the same task. (By contrast, UEPNQTOK is usable only for the duration of a single enqueue request, because its contents may be destroyed at the end of the request.) For example, if you need to pass information between successive invocations of the XNQEREQ exit, UEPTSTOK provides a means of doing this.

**Note:**

1. The lifetime of the area pointed to by UEPTSTOK is the lifetime of the task.
2. The value of UEPTSTOK is shared by all the exits to which it is passed during the lifetime of the task.

*Table 3. User arguments and associated keywords, data types, and input/output types*

Argument	Keyword	Data type	Input/output type
Arg1	RESOURCE	DATA-AREA	input
Arg2	LENGTH	BIN(15)	input
Arg3	MAXLIFETIME	CVDA	input

**Modifying user arguments:** User exit programs can modify user input arguments by:

1. Obtaining sufficient storage to hold the modified argument
2. Setting the storage to the required value
3. Setting the associated pointer in the parameter list to the address of the newly-acquired area.

**Note:**

1. CICS does not check changes to argument values, so any changes must be verified by the user exit program making the changes.
2. It is not advisable for XNQEREQC to modify input arguments.

**Adding user arguments:** Global user exit programs can add arguments associated with the LENGTH and MAXLIFETIME keywords. You must ensure that the arguments you specify or modify in your exit programs are valid. The valid values for MAXLIFETIME are DFHVALUE(TASK) and DFHVALUE(UOW), which are 233 and 246 respectively.

Assuming that the argument to be added does not already exist, the user exit program must:

1. Obtain storage for the argument to be added
2. Initialize the storage to the required value
3. Select and set up the appropriate pointer from the parameter list
4. Select and set up the appropriate argument existence bit in the EID
5. Modify the parameter list to reflect the new end of list indicator.

**Removing user arguments:** User exit programs can remove arguments (for which the program is totally responsible) associated with the LENGTH and MAXLIFETIME keywords:

Assuming that the argument to be removed exists, the user exit program must:

1. Switch the corresponding argument existence bit to '0'b in the EID
2. Modify the parameter list to reflect the new end of list indicator.

### **Sample exit program, DFH\$XNQE**

CICS supplies a sample exit program, DFH\$XNQE, for the XNQEREQ exit.

The program gives examples of:

- Coding Exec Interface Global User Exits
- Issuing a mixture of XPI and EXEC CICS API calls within Global User Exits
- Three methods of adding a SCOPE value to exec ENQ and DEQ requests, so that they apply to multiple regions within the Sysplex. Methods A and B force a match to an installed ENQMODEL resource definition. Method C bypasses the use of ENQMODEL resource definitions even if there would have been a match.

The methods are:

#### **Method A**

Prefix the Resource name with a 1- to 255-character value (this sample uses a 4-character value) for the ENQNAME on the ENQMODEL resource definition to which you wish to force a match. The exit terminates and processing continues as though the chosen ENQMODEL had been matched normally. The scope is then supplied by the matched ENQMODEL definition.

This method applies only to resource names shorter than 255-n (where n is the length of your chosen prefix).

#### **Method B**

Similar to method A, but you replace the first 1- to 8-characters of the resource name with your chosen string instead of prefixing it. This method:



- applies only to resource names of length equal to or greater than that of your replacement string.
- is an alternative to method A when a resource name too long to allow the use of that method.

### Method C

Place a 4-character Scope value in UEPSCOPE, and return UERCSCPE in R15. This will bypass any installed ENQMODEL resource definition, forcing a Sysplex Scope ENQ/DEQ request.

This method is not recommended if you have an ENQMODEL table, because the latter is designed to preserve data integrity by preventing the possibility of a region scope enqueue and a sysplex scope enqueue (or two sysplex scope enqueues with different scopes) existing for the same resource. (Because sysplex and region scope enqueues use separate namespaces, a region scope enqueue will never wait on a sysplex enqueue, nor will a sysplex scope enqueue wait on a region enqueue.)

### Related concepts

“The enqueue EXEC interface sample exit program” on page 19

### Notes about the use of XNQERREQ to alter ENQ or DEQ scope.:

1. XNQERREQ enables you to allow existing applications to be converted to use sysplex enqueues without changing the application.

**Note:** Use of either the ENQMODEL resource definition or the user exit allows this in most cases, but those applications where the resource name is determined dynamically and not known in advance can only be so converted by use of this exit.

2. Sysplex and region scope enqueues use separate namespaces. A region scope enqueue will never wait on a sysplex enqueue, nor will a sysplex scope enqueue wait on a region enqueue.

**Note:** This situation can only arise when you use the exit. Use of the ENQMODEL resource definitions as your only method of defining the SCOPE of an ENQ or DEQ avoids this potential risk.

3. Both region and sysplex scope are supported for string ENQs, but sysplex scope is not supported for address ENQs.

## EXEC interface program exits XEIIIN, XEIOUT, XEISPIN, and XEISPOUT

There are four global user exit points in the EXEC interface program:

**XEIIIN** Invoked before the execution of any EXEC CICS application programming interface (API) or system programming interface (SPI) command.

### XEISPIN

Invoked before the execution of any EXEC CICS SPI command *except*:

- EXEC CICS ENABLE
- EXEC CICS DISABLE
- EXEC CICS EXTRACT EXIT
- EXEC CICS PERFORM DUMP
- EXEC CICS RESYNC ENTRYNAME

The sequence is:

```
TRACE - XEIIIN - XEISPIN - EDF - command
```

## XEIOUT

Invoked after the execution of any EXEC CICS API or SPI command.

## XEISPOUT

Invoked after the execution of any EXEC CICS SPI command *except* those listed for XEISPIN.

The sequence is:

```
command - EDF - XEISPOUT - XEIOUT - TRACE
```

**Note:** Asynchronous processing of these exits may occur if the transaction is suspended (for example, during file I/O wait). This situation may also occur under CEDF because CEDF issues its own EXEC CICS commands between the application's XEISPIN and XEISPOUT exits.

If, for example, the same GWA is shared between the XEIIN and XEIOUT exits, you must allow for the possibility of asynchronous processing, in order to ensure integrity of the data and to prevent unpredictable results.

On entry to the exits, the exit-specific parameter UEPARG contains the address of the command parameter list.

## The command parameter list

The first parameter in the list points to a string of data known as **argument 0**. The other parameters point to the values specified for the parameters passed on the command.

**Argument 0** begins with a 2-byte function code that identifies the command. (Function codes are documented in Appendix A of the *CICS Application Programming Reference* and in Appendix B of the *CICS System Programming Reference*.) The function code is followed by a 2-byte field containing “existence bits” which indicate whether arguments are passed on the command. For example, consider the command:

```
EXEC CICS LINK PROGRAM('MYPROG')
```

Here, argument 0 begins with the function code X'0E02' (LINK). Existence bit 1 is set, indicating that there is an argument 1 (namely, 'MYPROG').

The correspondence between command parameters (such as PROGRAM) and their positions and values in the parameter list (in this case, argument 1, 'MYPROG') can be deduced from the translated code for the particular command.

## Important

Modifying CICS commands by tampering with argument 0 is **not** supported, and leads to unexpected errors or results.

For example, if an application program is written in assembler or PL/I and you modify argument 0, you will be writing to program storage (that is, storage occupied by the program itself), which could cause 0C4 abends. Furthermore, modifying argument 0 not only alters the CICS command for *this execution* of the command in the application program, it changes the CICS command in the virtual storage copy of the application program. This means that the next task to invoke the same copy of the program will also execute the modified command.

This particular example of the danger of tampering with argument 0 does not apply to COBOL or C application programs, but nevertheless you should not modify CICS commands for application programs written in any supported language.

## **Bypassing commands**

An XEIIIN or XEISPIN exit program can bypass execution of a command by setting the UERCBYP return code. If it does this, EDF is not invoked, but XEISPOUT, XEIOUT, and exit trace are invoked if they are active.

Bypassing an EXEC CICS command allows an exit program to replace the CICS function with its own processing, for example.

Before setting UERCBYP, your program should check the value pointed to by UEPPGM, to ensure that it is not bypassing an EXEC CICS command issued by CICS.

## **Exit XEIIIN**

### **When invoked**

Before the execution of any EXEC CICS API or SPI command.

### **Exit-specific parameters**

#### **UEPARG**

Address of the EXEC command parameter list.

#### **UEPEXECB**

Address of the system EIB.

#### **UEPUSID**

Address of the 8-character userid.

#### **UEPPGM**

Address of the 8-character application program name.

#### **UEPLOAD**

Address of the application program's load-point.

#### **UEPRSA**

Address of the application's register save area. This contains the contents of the registers at the point when the program issued the EXEC CICS command.

#### **UEP\_EI\_PBTOK**

Address of a 4-byte field containing the z/OS Workload Manager (WLM) Performance Block Token. An exit program can use this token to access information (such as the service class token, SERVCLS) in the WLM Performance Block. To do so, it must use the WLM EXTRACT macro, IWMMEXTR, passing the Performance Block Token as the MONTKN input parameter. For more information about the IWMMEXTR macro, see *z/OS MVS Programming: Workload Management Services*.

An exit program must not attempt to modify the Performance Block: if it does so, the results are unpredictable.

### **Return codes**

#### **UERCNORM**

Continue processing.

#### **UERCBYP**

Bypass the execution of this command.

**UERPURG**

Task purged during XPI call.

**XPI calls**

All can be used.

**Exit XEISPIN****When invoked**

Before the execution of any EXEC CICS SPI command *except*:

- EXEC CICS ENABLE
- EXEC CICS DISABLE
- EXEC CICS EXTRACT EXIT
- EXEC CICS PERFORM DUMP
- EXEC CICS RESYNC ENTRYNAME

**Exit-specific parameters****UEPARG**

Address of the EXEC command parameter list.

**UEPEXECB**

Address of the system EIB.

**UEPUSID**

Address of the 8-character userid.

**UEPPGM**

Address of the 8-character application program name.

**UEPLOAD**

Address of the application program's load-point.

**UEPRSA**

Address of the application's register save area. This contains the contents of the registers at the point when the program issued the EXEC CICS command.

**UEP\_EI\_PBTOK**

Address of a 4-byte field containing the z/OS Workload Manager (WLM) Performance Block Token. An exit program can use this token to access information (such as the service class token, SERVCLS) in the WLM Performance Block. To do so, it must use the WLM EXTRACT macro, IWMMEXTR, passing the Performance Block Token as the MONTKN input parameter. For more information about the IWMMEXTR macro, see *z/OS MVS Programming: Workload Management Services*.

An exit program must not attempt to modify the Performance Block: if it does so, the results are unpredictable.

**Return codes****UERCNORM**

Continue processing.

**UERCBYB**

Bypass the execution of this command.

**UERPURG**

Task purged during XPI call.

## XPI calls

All can be used.

## Exit XEIOUT

### When invoked

After the execution of any EXEC CICS API or SPI command.

### Exit-specific parameters

#### UEPARG

Address of the EXEC command parameter list.

#### UEPEXECB

Address of the system EIB.

#### UEPUSID

Address of the 8-character userid.

#### UEPPGM

Address of the 8-character application program name.

#### UEPLOAD

Address of the application program's load-point.

#### UEPRSA

Address of the application's register save area. This contains the contents of the registers at the point when the program issued the EXEC CICS command.

#### UEP\_EI\_PBTOK

Address of a 4-byte field containing the z/OS Workload Manager (WLM) Performance Block Token. An exit program can use this token to access information (such as the service class token, SERVCLS) in the WLM Performance Block. To do so, it must use the WLM EXTRACT macro, IWMMEXTR, passing the Performance Block Token as the MONTKN input parameter. For more information about the IWMMEXTR macro, see *z/OS MVS Programming: Workload Management Services*.

An exit program must not attempt to modify the Performance Block: if it does so, the results are unpredictable.

### Return codes

#### UERCNORM

Continue processing.

#### UERCPURG

Task purged during XPI call.

## XPI calls

All can be used.

## Exit XEISPOUT

### When invoked

After the execution of any EXEC CICS SPI command *except*:

- EXEC CICS ENABLE
- EXEC CICS DISABLE
- EXEC CICS EXTRACT EXIT
- EXEC CICS PERFORM DUMP
- EXEC CICS RESYNC ENTRYNAME

## Exit-specific parameters

### UEPARG

Address of the EXEC command parameter list.

### UEPEXECB

Address of the system EIB.

### UEPUSID

Address of the 8-character userid.

### UEPPGM

Address of the 8-character application program name.

### UEPLOAD

Address of the application program's load-point.

### UEPRSA

Address of the application's register save area. This contains the contents of the registers at the point when the program issued the EXEC CICS command.

### UEP\_EI\_PBTOK

Address of a 4-byte field containing the z/OS Workload Manager (WLM) Performance Block Token. An exit program can use this token to access information (such as the service class token, SERVCLS) in the WLM Performance Block. To do so, it must use the WLM EXTRACT macro, IWMMEXTR, passing the Performance Block Token as the MONTKN input parameter. For more information about the IWMMEXTR macro, see *z/OS MVS Programming: Workload Management Services*.

An exit program must not attempt to modify the Performance Block: if it does so, the results are unpredictable.

## Return codes

### UERCNORM

Continue processing.

### UERCPURG

Task purged during XPI call.

## XPI calls

All can be used.

## File control domain exits, XFCFRIN and XFCFROUT

### XFCFRIN

If enabled, the XFCFRIN exit is invoked on entry to the main file control request gate, FCFR. It allows you to:

- Monitor file control requests and allow them to continue, to be processed by CICS file control
- Intercept file control requests and bypass CICS file control processing altogether
- Redirect the request to a remote region.

The request may have originated from:

- The execution of an application request to process a user file
- The receipt of a function-shipped request

- An internal CICS request to process a system file.

Note that:

- If the exit program passes the request to CICS file control (without choosing to redirect it to a remote region), it is not allowed to make changes to any of the parameters.
- If the exit program intercepts the request and bypasses file control:
  - It must return all the responses and output parameters that would otherwise have been returned by file control. These are marked **output** in the descriptions of the exit-specific parameters below.
  - It must indicate whether, if the request was function-shipped, the mirror transaction is permitted to terminate. Certain file control requests require that another request has been executed previously in the same transaction. (For example, READNEXT must be preceded by a matching STARTBR; REWRITE must be preceded by a matching READ, READNEXT, or READPREV with the UPDATE option). If the mirror transaction terminates between two such requests, the second is likely to fail. Conversely, a mirror transaction that is retained unnecessarily will hold on to CICS resources and may contribute to storage and locking problems.
  - CICS terminates file browses and outstanding updates as part of syncpoint processing. However, the XFCFRIN exit is not invoked for syncpoint. If you want to emulate this aspect of CICS behavior accurately, or you want to support recoverable resources, you must invoke a task-related user exit program which schedules the syncpoint manager—see “Coding a program to be invoked by the CICS syncpoint manager” on page 293.
- To redirect the request to a remote region, the exit program must add or change the value of the SYSID parameter. In this case, it may also need to supply the values of the key length and record length. It is not permitted to make changes to any of the other parameters.

The FCFR functions (**UEP\_FC\_FUNCTION**) are derived from those available through the EXEC CICS interface, where certain of the request options (SET, INTO, UPDATE) have been included in the function values. (For example, UEP\_FC\_FUN\_DELETE is derived from EXEC CICS DELETE with the RIDFLD option specified; UEP\_FC\_FUN\_REWRITE\_DELETE is derived from EXEC CICS DELETE without RIDFLD.)

## XFCFROUT

If enabled, the XFCFROUT exit is invoked after completion of a file control request. It is invoked in both the following cases:

- After CICS file control has completed its processing, either normally or with an error
- If your XFCFRIN exit program chooses to bypass CICS file control processing.

XFCFROUT allows you to monitor the results of completed file control requests. For example, if you didn't choose to bypass CICS file control processing, you can analyze the (CICS-internal) file control request to determine its type, the parameters passed to file control, and the values returned.

All parameters are input-only; your exit program cannot modify any of the values.

## Exit XFCFRIN

### When invoked

Before the execution of a file control request. The request may have originated from:

- The execution of an application request to process a user file
- The receipt of a function-shipped request
- An internal CICS request to process a system file.

### Exit-specific parameters

#### UEPTRANID

Address of the 4-byte transaction ID.

#### UEPUSER

Address of the 8-byte user ID.

#### UEPTERM

Address of the 4-byte terminal ID.

#### UEPPROG

Address of the 8-byte application program name.

#### UEP\_FC\_FUNCTION

Address of a byte containing the function. The possible values are:

- UEP\_FC\_FUN\_READ\_INTO
- UEP\_FC\_FUN\_READ\_SET
- UEP\_FC\_FUN\_READ\_UPDATE\_INTO
- UEP\_FC\_FUN\_READ\_UPDATE\_SET
- UEP\_FC\_FUN\_WRITE
- UEP\_FC\_FUN\_REWRITE
- UEP\_FC\_FUN\_REWRITE\_DELETE
- UEP\_FC\_FUN\_DELETE
- UEP\_FC\_FUN\_UNLOCK
- UEP\_FC\_FUN\_START\_BROWSE
- UEP\_FC\_FUN\_READ\_NEXT\_INTO
- UEP\_FC\_FUN\_READ\_NEXT\_SET
- UEP\_FC\_FUN\_READ\_PREVIOUS\_INTO
- UEP\_FC\_FUN\_READ\_PREVIOUS\_SET
- UEP\_FC\_FUN\_READ\_NEXT\_UPDATE\_INTO
- UEP\_FC\_FUN\_READ\_NEXT\_UPDATE\_SET
- UEP\_FC\_FUN\_READ\_PREVIOUS\_UPDATE\_INTO
- UEP\_FC\_FUN\_READ\_PREVIOUS\_UPDATE\_SET
- UEP\_FC\_FUN\_RESET\_BROWSE
- UEP\_FC\_FUN\_END\_BROWSE

#### UEPTSTOK

Address of a 4-byte token that is valid throughout the life of a task. See “Use of the task token UEPTSTOK” on page 93.

#### UEP\_FC\_FILE\_NAME

Address of an 8-byte modifiable field containing the filename.

#### UEP\_FC\_BUFFER\_P

Address of a fullword containing the address of the buffer provided by the originator of the request, in which the (**output**) record is to be returned on completion of a READ, READ NEXT, or READ PREV request with the INTO option.



### **UEP\_FC\_BUFFER\_L**

Address of a fullword containing (for READ, READ NEXT, and READ PREV requests) the value of the LENGTH of the buffer into which the record is to be read.

### **UEP\_FC\_RECORD\_P**

Address of one of the following:

- If the request is a READ, READ NEXT, or READ PREV with the SET option, a fullword in which is to be returned the address (**output**) of a buffer, into which the record will be placed. The buffer itself is supplied either by CICS file control or, if the exit program bypasses file control, by the exit program.
- If the request is WRITE or REWRITE, a fullword containing the address of the record to be written.

### **UEP\_FC\_RECORD\_L**

Address of a fullword containing (for READ, WRITE, REWRITE, READ NEXT, and READ PREV requests) the value of LENGTH.

For all READ, READ NEXT, or READ PREV requests, this is an **output** field, in which the actual length of the record read is placed on return.

**Warning:** For requests that specify INTO, do not change the value of LENGTH to a value greater than the value specified by the UEP\_FC\_BUFFER\_L field. To do so could cause a storage overlay in the application.

For a WRITE or REWRITE, this is an optional field which, if present, contains the length of the record to be written. If the field is not specified, the fullword contains binary zeroes. In this case, to modify the record length for a remote file use UEP\_FC\_M\_RECORD\_L instead.

See also the description of the UEP\_FC\_SYSID parameter.

### **UEP\_FC\_MAX\_RECORD\_L**

Address of a fullword containing the (**output**) maximum record length of the file. (CICS function shipping uses this value to update the file's entry in the remote file control table.)

### **UEP\_FC\_RECORD\_ID\_P**

Address of a fullword containing the address of the RIDFLD (record identifier) value. For a discussion of when the record identifier is an input or an **output** field, see Table 4 on page 91.

### **UEP\_FC\_RECORD\_ID\_L**

Address of the halfword value of KEYLENGTH, which is the (possibly partial) length of the record identifier.

KEYLENGTH is an optional input parameter on READ, WRITE, DELETE, START BR, READ NEXT, READ PREV, and RESET BR requests. If the field is not specified, the halfword contains binary zeroes. In this case, to modify the key length for a remote file use UEP\_FC\_M\_RECORD\_ID\_L instead.

See also the description of the UEP\_FC\_SYSID parameter.

### **UEP\_FC\_FULL\_RECORD\_ID\_L**

Address of the halfword value of the full length of the record identifier.

The full length of the record identifier is returned as a mandatory **output** field on READ NEXT and READ PREV requests. The value is used by CICS function shipping.

**UEP\_FC\_RECORD\_ID\_TYPE**

Address of a byte containing (for READ, WRITE, DELETE, START BR, READ NEXT, READ PREV, and RESET BR requests) the RIDFLD type. On input to the exit, this parameter will be set to one of:

**UEP\_FC\_KEY**

VSAM KSDS or AIX® PATH access

**UEP\_FC\_RBA**

VSAM ESDS or KSDS via RBA access

**UEP\_FC\_RRN**

VSAM RRDS access

**UEP\_FC\_DEBKEY**

BDAM deblocking by key (READ, DELETE, START BR, and RESET BR requests only)

**UEP\_FC\_DEBREC**

BDAM deblocking by relative record (READ, DELETE, START BR, and RESET BR requests only)

**UEP\_FC\_XRBA**

VSAM extended ESDS access

**UEP\_FC\_REQID**

Address (for START BR, READ NEXT, READ PREV, RESET BR, and END BR requests) of the halfword value of REQID.

**UEP\_FC\_NUMREC**

Address of the fullword value of NUMREC (**output**), in which (if the request is DELETE with RIDFLD) the number of records that have been deleted is returned.

**UEP\_FC\_KEY\_COMPARISON**

Address of a byte containing (for READ, START BR, and RESET BR requests) the key comparison setting. On input to the exit, this parameter will be set to one of:

**UEP\_FC\_EQUAL**

Key-equal-to comparison is to be used.

**UEP\_FC\_GTEQ**

Key-greater-than-or-equal-to comparison is to be used.

**UEP\_FC\_GENERIC**

Address of a byte containing (for READ, DELETE, START BR, and RESET BR requests) the generic key setting. On input to the exit, this parameter will be set to one of:

**UEP\_FC\_GENERIC\_KEY**

Generic key is to be used for key search.

**UEP\_FC\_FULL\_KEY**

Full key is to be used for key search.

**UEP\_FC\_MASS\_INSERT**

Address of a byte containing (for WRITE requests) the mass insert setting. On input to the exit, this parameter will be set to one of:

**UEP\_FC\_SEQUENTIAL\_WRITE**

Records are to be written in sequential mode.

**UEP\_FC\_DIRECT\_WRITE**

Records are to be written in direct mode.

**UEP\_FC\_READ\_INTEGRITY**

Address of a byte containing (for non-update READ, READ NEXT, and READ PREV requests) the read integrity setting. (In current versions of CICS, this setting applies only to VSAM RLS.) On input to the exit, this parameter will be set to one of:

**UEP\_FC\_CR**

Consistent read integrity is to be used.

**UEP\_FC\_FCT\_VALUE**

Read integrity is according to the setting in the FILE definition.

**UEP\_FC\_NRI**

The record is to be read with no read integrity.

**UEP\_FC\_RR**

Repeatable read integrity is to be used.

**UEP\_FC\_TOKEN**

Address of a fullword containing the value of TOKEN.

If the request is READ, READ NEXT, or READ PREV with update, and the address is not null, the area is an **output** field in which the token is to be returned.

If the request is REWRITE, DELETE without RIDFLD, or UNLOCK, the area is an input field.

**UEP\_FC\_SYSID**

Address of a 4-byte area that is to contain the SYSID identifying the remote region. On input to the exit, the area contains either:

- The value of the SYSID option of the API call, *or*
- Blanks (if SYSID was not specified).

To redirect the request to a different region, the exit program must place the SYSID of the target region in this **output** area.

If this parameter is set by the exit program, the request is function-shipped by file control without any reference to the file's attributes. If the key length has not been included on the request, the exit program must establish its value by setting the UEP\_FC\_RECORD\_ID\_L parameter.

Similarly, if the request is WRITE or REWRITE, and the record length has not been specified on the request, the exit program must establish its value by setting the UEP\_FC\_RECORD\_L parameter.

**UEP\_FC\_LENGTH\_ERROR\_CODE**

Address of a 1-byte **output** area containing the length error code to be returned after a request has completed. The possible values are:

- UEP\_FC\_LENGTH\_OK
- UEP\_FC\_BUFFER\_LEN\_TOO\_SMALL
- UEP\_FC\_RECORD\_LEN\_TOO\_LARGE
- UEP\_FC\_BUFFER\_LEN\_NOT\_FILE\_LEN
- UEP\_FC\_RECORD\_LEN\_NOT\_FILE\_LEN

**UEP\_FC\_DUPLICATE\_KEY\_CODE**

Address of a 1-byte **output** area indicating whether the request found more than one record for the supplied key. The possible values are:

- UEP\_FC\_DUPLICATE KEY
- UEP\_FC\_NOT\_DUPLICATE KEY

**UEP\_FC\_ACCMETH\_RETURN\_CODE**

Address of a 4-byte **output** area in which access-method-dependent information is to be returned when either of the responses UEP\_FC\_REASON\_ACCMETH\_REQUEST\_ERROR or UEP\_FC\_REASON\_IO\_ERROR is returned.

The returned value is placed in bytes 2–5 of the EIBRCODE.

**UEP\_FC\_RESPONSE**

Address of a 1-byte **output** area containing the response after a request has completed:

**UEP\_FC\_RESPONSE\_OK**

Processing has completed without errors.

**UEP\_FC\_RESPONSE\_EXCEPTION**

Processing has completed with an error condition. The reason is set in UEP\_FC\_REASON.

**UEP\_FC\_RESPONSE\_DISASTER**

An error has occurred which prevents processing from completing. Typically, this is as a result of a DISASTER response from an XPI function call, or corruption of data addressed from UEPGAA or UEPTSTOK.

If you set this response, the caller of file control will assume that first-failure data capture has been performed. If you are percolating a DISASTER response from an XPI request, first-failure data capture will have been performed already; if not, you should attempt to capture sufficient information to successfully diagnose the error. The DFHDUDUX SYSTEM\_DUMP XPI function may be suitable for this purpose.

**UEP\_FC\_RESPONSE\_INVALID**

The exit program was invoked with an invalid parameter list, indicating a CICS internal logic error. Note that an invalid parameter list that indicates an application error should give an EXCEPTION response.

**UEP\_FC\_RESPONSE\_PURGED**

An XPI function call has received a PURGED response. Setting this response is equivalent to setting the UERCPURG return code, except that any changes to the parameter list are honored.

**UEP\_FC\_REASON**

Address of a 1-byte **output** area containing, after a request has completed with an EXCEPTION response, the reason. The possible reasons are:

- UEP\_FC\_REASON\_ACCMETH\_REQUEST\_ERROR
- UEP\_FC\_REASON\_DELETE\_AFTER\_READ\_UPDATE
- UEP\_FC\_REASON\_DELETE\_BEFORE\_READ\_UPDATE
- UEP\_FC\_REASON\_DUPLICATE\_READ\_UPDATE

- UEP\_FC\_REASON\_DUPLICATE\_RECORD
- UEP\_FC\_REASON\_DUPLICATE\_REQID
- UEP\_FC\_REASON\_END\_OF\_FILE
- UEP\_FC\_REASON\_FILE\_DISABLED
- UEP\_FC\_REASON\_FILE\_NOT\_OPEN
- UEP\_FC\_REASON\_FILE\_NOT\_FOUND
- UEP\_FC\_REASON\_FULL\_KEY\_WRONG\_LENGTH
- UEP\_FC\_REASON\_GENERIC\_DELETE\_NOT\_KSDS
- UEP\_FC\_REASON\_GENERIC\_KEY\_TOO\_LONG
- UEP\_FC\_REASON\_ILLEGAL\_KEY\_TYPE\_CHANGE
- UEP\_FC\_REASON\_INSUFFICIENT\_SPACE
- UEP\_FC\_REASON\_INVALID\_UPDATE\_TOKEN
- UEP\_FC\_REASON\_IO\_ERROR
- UEP\_FC\_REASON\_KEY\_LENGTH\_NEGATIVE
- UEP\_FC\_REASON\_KSDS\_AND\_XRBA
- UEP\_FC\_REASON\_NO\_VARIABLE\_LENGTH
- UEP\_FC\_REASON\_NOTAUTH
- UEP\_FC\_REASON\_NOT\_EXTENDED
- UEP\_FC\_REASON\_READPREV\_IN\_GENERIC\_BROWSE
- UEP\_FC\_REASON\_RECORD\_NOT\_FOUND
- UEP\_FC\_REASON\_REWRITE\_BEFORE\_READ\_UPDATE
- UEP\_FC\_REASON\_RIDFLD\_KEY\_NOT\_RECORD\_KEY
- UEP\_FC\_REASON\_UNKNOWN\_REQID\_ENDBR
- UEP\_FC\_REASON\_UNKNOWN\_REQID\_READNEXT
- UEP\_FC\_REASON\_UNKNOWN\_REQID\_READPREV
- UEP\_FC\_REASON\_UNKNOWN\_REQID\_RESETBR

#### **UEP\_FC\_EXIT\_TOKEN**

Address of a 4-byte token to be passed to XFCFROUT. This allows you, for example, to pass a work area to exit XFCFROUT.

#### **UEP\_FC\_M\_RECORD\_L**

Address of a fullword containing the modified record length field. You can use this to change the LENGTH, for remote files only, when the LENGTH field is not specified on the API call. If the LENGTH field is specified on the API call, to change the LENGTH use UEP\_FC\_RECORD\_L instead, because changing the value at the address stored by UEP\_FC\_M\_RECORD\_L has no effect.

#### **UEP\_FC\_M\_RECORD\_ID\_L**

Address of a halfword containing the modified key length field. You can use this to change the KEYLENGTH, for remote files only, when the KEYLENGTH field is not specified on the API call. If the KEYLENGTH field is specified, to change the KEYLENGTH use UEP\_FC\_RECORD\_ID\_L instead, because changing the value at the address stored by UEP\_FC\_M\_RECORD\_ID\_L has no effect.

### **Return codes**

#### **UERCNORM**

Continue processing.

#### **UERCBYB**

Bypass CICS processing of this request. If the exit program has been invoked for a function-shipped request, the mirror transaction is permitted to terminate.

**UERCBYPL**

Bypass CICS processing of this request. If the exit program has been invoked for a function-shipped request, the mirror transaction must not terminate.

**UERC PURG**

Task purged during XPI call.

**XPI calls**

All can be used.

**API and SPI calls**

None can be used.

**Exit XFCFROUT****When invoked**

After the completion of a file control request.

**Exit-specific parameters****UEPTRANID**

Address of the 4-byte transaction ID.

**UEPUSER**

Address of the 8-byte user ID.

**UEPTERM**

Address of the 4-byte terminal ID.

**UEPPROG**

Address of the 8-byte application program name.

**UEP\_FC\_FUNCTION**

Address of a byte containing the function. The possible values are:

- UEP\_FC\_FUN\_READ\_INT0
- UEP\_FC\_FUN\_READ\_SET
- UEP\_FC\_FUN\_READ\_UPDATE\_INT0
- UEP\_FC\_FUN\_READ\_UPDATE\_SET
- UEP\_FC\_FUN\_WRITE
- UEP\_FC\_FUN\_REWRITE
- UEP\_FC\_FUN\_REWRITE\_DELETE
- UEP\_FC\_FUN\_DELETE
- UEP\_FC\_FUN\_UNLOCK
- UEP\_FC\_FUN\_START\_BROWSE
- UEP\_FC\_FUN\_READ\_NEXT\_INT0
- UEP\_FC\_FUN\_READ\_NEXT\_SET
- UEP\_FC\_FUN\_READ\_PREVIOUS\_INT0
- UEP\_FC\_FUN\_READ\_PREVIOUS\_SET
- UEP\_FC\_FUN\_READ\_NEXT\_UPDATE\_INT0
- UEP\_FC\_FUN\_READ\_NEXT\_UPDATE\_SET
- UEP\_FC\_FUN\_READ\_PREVIOUS\_UPDATE\_INT0
- UEP\_FC\_FUN\_READ\_PREVIOUS\_UPDATE\_SET
- UEP\_FC\_FUN\_RESET\_BROWSE
- UEP\_FC\_FUN\_END\_BROWSE

**UEPTSTOK**

Address of a 4-byte token that is valid throughout the life of a task. See "Use of the task token UEPTSTOK" on page 93.

**UEP\_FC\_FILE\_NAME**

Address of an 8-byte field containing the filename.

**UEP\_FC\_BUFFER\_P**

Address of a fullword containing the address of the buffer provided by the originator of the request, in which the record is returned on completion of a READ, READ NEXT, or READ PREV request with the INTO option.

**UEP\_FC\_BUFFER\_L**

Address of a fullword containing (for READ, READ NEXT, and READ PREV requests) the value of the LENGTH of the buffer into which the record was read.

**UEP\_FC\_RECORD\_P**

Address of one of the following:

- If the request is a READ, READ NEXT, or READ PREV request with the SET option, a fullword in which is returned the address of a buffer, into which the record was placed.
- If the request is WRITE or REWRITE, a fullword containing the address of the record that was written.

**UEP\_FC\_RECORD\_L**

Address of a fullword containing (for READ, WRITE, REWRITE, READ NEXT, and READ PREV requests) the value of LENGTH.

For all READ, READ NEXT, or READ PREV requests, this is an output field, containing the actual length of the record read. For these types of request, this record-length value is always present, even if the LENGTH option was not specified on the EXEC CICS API call.

For a WRITE or REWRITE, this is an optional field which, if present, contains the length of the record that was written.

**UEP\_FC\_MAX\_RECORD\_L**

Address of a fullword containing the maximum record length of the file.

**UEP\_FC\_RECORD\_ID\_P**

Address of a fullword containing the address of the value of RIDFLD (record identifier). For a discussion of when the record identifier is an input or an output field, see Table 4 on page 91.

**UEP\_FC\_RECORD\_ID\_L**

Address of the halfword value of KEYLENGTH, which is the (possibly partial) length of the record identifier.

The length of the record identifier is an optional input parameter on READ, WRITE, DELETE, START BR, READ NEXT, READ PREV, and RESET BR requests.

**UEP\_FC\_FULL\_RECORD\_ID\_L**

Address of the halfword value of the full length of the record identifier. (The full length of the record identifier corresponds to the KEYLENGTH keyword of the EXEC CICS interface.)

The full length of the record identifier is returned as a mandatory output field on READ NEXT and READ PREV requests.

**UEP\_FC\_RECORD\_ID\_TYPE**

Address of a byte containing (for READ, WRITE, DELETE, START BR, READ NEXT, READ PREV, and RESET BR requests) the RIDFLD type.

**UEP\_FC\_KEY**

VSAM KSDS or AIX PATH access

**UEP\_FC\_RBA**

VSAM ESDS or KSDS via RBA access

**UEP\_FC\_RRN**

VSAM RRDS access

**UEP\_FC\_DEBKEY**

BDAM deblocking by key (READ, DELETE, START BR, and RESET BR requests only)

**UEP\_FC\_DEBREC**

BDAM deblocking by relative record (READ, DELETE, START BR, and RESET BR requests only)

**UEP\_FC\_XRBA**

VSAM extended ESDS access

**UEP\_FC\_REQID**

Address (for START BR, READ NEXT, READ PREV, RESET BR, and END BR requests) of the halfword value of REQID.

**UEP\_FC\_NUMREC**

Address of the fullword value of NUMREC, in which (if the request is DELETE with RIDFLD) the number of records that have been deleted is returned.

**UEP\_FC\_KEY\_COMPARISON**

Address of a byte containing (for READ, START BR, and RESET BR requests) the key comparison setting.

**UEP\_FC\_EQUAL**

Key-equal-to comparison.

**UEP\_FC\_GTEQ**

Key-greater-than-or-equal-to comparison.

**UEP\_FC\_GENERIC**

Address of a byte containing (for READ, DELETE, START BR, and RESET BR requests) the generic key setting.

**UEP\_FC\_GENERIC\_KEY**

Generic key used for key search.

**UEP\_FC\_FULL\_KEY**

Full key used for key search.

**UEP\_FC\_MASS\_INSERT**

Address of a byte containing (for WRITE requests) the mass insert setting.

**UEP\_FC\_SEQUENTIAL\_WRITE**

Sequential mode.

**UEP\_FC\_DIRECT\_WRITE**

Direct mode.

**UEP\_FC\_READ\_INTEGRITY**

Address of a byte containing (for non-update READ, READ NEXT, and READ PREV requests) the read integrity setting. (In current versions of CICS, this setting applies only to VSAM RLS.)



**UEP\_FC\_CR**

Consistent read integrity.

**UEP\_FC\_FCT\_VALUE**

Read integrity according to the setting in the FILE definition.

**UEP\_FC\_NRI**

No read integrity.

**UEP\_FC\_RR**

Repeatable read integrity.

**UEP\_FC\_TOKEN**

Address of a fullword containing the value of TOKEN.

If the request is READ, READ NEXT, or READ PREV with update, and the address is not null, the area is an output field in which the token is returned.

If the request is REWRITE, DELETE without RIDFLD, or UNLOCK, the area is an input field.

**UEP\_FC\_SYSID**

Address of a 4-byte area that contains the SYSID identifying the remote region. On input to the XFCFRIN exit, the area contained either:

- The value of the SYSID option of the API call, *or*
- Blanks (if SYSID was not specified).

If the XFCFRIN exit redirected the request to a different region, the area contains the SYSID of the remote region.

**UEP\_FC\_LENGTH\_ERROR\_CODE**

Address of a 1-byte area containing the length error code returned after the request completed. The possible values are:

- UEP\_FC\_LENGTH\_OK
- UEP\_FC\_BUFFER\_LEN\_TOO\_SMALL
- UEP\_FC\_RECORD\_LEN\_TOO\_LARGE
- UEP\_FC\_BUFFER\_LEN\_NOT\_FILE\_LEN
- UEP\_FC\_RECORD\_LEN\_NOT\_FILE\_LEN

**UEP\_FC\_DUPLICATE\_KEY\_CODE**

Address of a 1-byte area indicating whether the request found more than one record for the supplied key. The possible values are:

- UEP\_FC\_DUPLICATE KEY
- UEP\_FC\_NOT\_DUPLICATE KEY

**UEP\_FC\_ACCMETH\_RETURN\_CODE**

Address of a 4-byte area in which access-method-dependent information is returned when either of the responses UEP\_FC\_REASON\_ACCMETH\_REQUEST\_ERROR or UEP\_FC\_REASON\_IO\_ERROR is returned.

**UEP\_FC\_RESPONSE**

Address of a 1-byte area containing the response after the request completed:

- UEP\_FC\_RESPONSE\_OK
- UEP\_FC\_RESPONSE\_EXCEPTION
- UEP\_FC\_RESPONSE\_DISASTER
- UEP\_FC\_RESPONSE\_INVALID
- UEP\_FC\_RESPONSE\_PURGED

## UEP\_FC\_REASON

Address of a 1-byte area containing, if the request completed with an EXCEPTION response, the reason. The possible reasons are:

- UEP\_FC\_REASON\_ABEND
- UEP\_FC\_REASON\_ACCMETH\_REQUEST\_ERROR
- UEP\_FC\_REASON\_BDAM\_DELETE
- UEP\_FC\_REASON\_BDAM\_LENGTH\_CHANGE
- UEP\_FC\_REASON\_BDAM\_KEY\_CONVERSION
- UEP\_FC\_REASON\_BDAM\_READ\_PREVIOUS
- UEP\_FC\_REASON\_BDAM\_WRITE\_MASS\_INSERT
- UEP\_FC\_REASON\_BROWSE\_UPD\_NOT\_RLS
- UEP\_FC\_REASON\_CACHE\_FAILURE
- UEP\_FC\_REASON\_CFDT\_CONNECT\_ERROR
- UEP\_FC\_REASON\_CFDT\_DISCONNECT\_ERROR
- UEP\_FC\_REASON\_CFDT\_INVALID\_CONTINUATION
- UEP\_FC\_REASON\_CFDT\_POOL\_FULL
- UEP\_FC\_REASON\_CFDT\_REOPEN\_ERROR
- UEP\_FC\_REASON\_CFDT\_SERVER\_NOT\_AVAILABLE
- UEP\_FC\_REASON\_CFDT\_SERVER\_NOT\_FOUND
- UEP\_FC\_REASON\_CFDT\_SYSIDERR
- UEP\_FC\_REASON\_CFDT\_TABLE\_GONE
- UEP\_FC\_REASON\_CHANGED
- UEP\_FC\_REASON\_CR\_NOT\_RLS
- UEP\_FC\_REASON\_DATASET\_BEING\_COPIED
- UEP\_FC\_REASON\_DEADLOCK\_DETECTED
- UEP\_FC\_REASON\_DELETE\_AFTER\_READ\_UPDATE
- UEP\_FC\_REASON\_DELETE\_BEFORE\_READ\_UPDATE
- UEP\_FC\_REASON\_DISASTER\_PERCOLATION
- UEP\_FC\_REASON\_DUPLICATE\_READ\_UPDATE
- UEP\_FC\_REASON\_DUPLICATE\_RECORD
- UEP\_FC\_REASON\_DUPLICATE\_REQID
- UEP\_FC\_REASON\_END\_OF\_FILE
- UEP\_FC\_REASON\_ESDS\_DELETE
- UEP\_FC\_REASON\_FILE\_DISABLED
- UEP\_FC\_REASON\_FILE\_NOT\_OPEN
- UEP\_FC\_REASON\_FILE\_NOT\_RECOVERABLE
- UEP\_FC\_REASON\_FILE\_NOT\_FOUND
- UEP\_FC\_REASON\_FULL\_KEY\_WRONG\_LENGTH
- UEP\_FC\_REASON\_GENERIC\_DELETE\_NOT\_KSDS
- UEP\_FC\_REASON\_GENERIC\_KEY\_TOO\_LONG
- UEP\_FC\_REASON\_ILLEGAL\_KEY\_TYPE\_CHANGE
- UEP\_FC\_REASON\_INSUFFICIENT\_SPACE
- UEP\_FC\_REASON\_INVALID\_UPDATE\_TOKEN
- UEP\_FC\_REASON\_IO\_ERROR
- UEP\_FC\_REASON\_ISCINVREQ
- UEP\_FC\_REASON\_ISC\_NOT\_SUPPORTED
- UEP\_FC\_REASON\_KEY\_LENGTH\_NEGATIVE
- UEP\_FC\_REASON\_KEY\_STOLEN
- UEP\_FC\_REASON\_KSDS\_AND\_XRBA
- UEP\_FC\_REASON\_LOADING
- UEP\_FC\_REASON\_LOCKED
- UEP\_FC\_REASON\_LOST\_LOCKS
- UEP\_FC\_REASON\_LOCK\_STRUCTURE\_FULL
- UEP\_FC\_REASON\_NOT\_IN\_SUBSET
- UEP\_FC\_REASON\_NO\_VARIABLE\_LENGTH
- UEP\_FC\_REASON\_NOSUSPEND\_NOT\_RLS

- UEP\_FC\_REASON\_NOTAUTH
- UEP\_FC\_REASON\_NOT\_EXTENDED
- UEP\_FC\_REASON\_PREVIOUS\_RLS\_FAILURE
- UEP\_FC\_REASON\_RBA\_ACCESS\_TO\_RLS\_KSDS
- UEP\_FC\_REASON\_READ\_NOT\_AUTHORISED
- UEP\_FC\_REASON\_READPREV\_IN\_GENERIC\_BROWSE
- UEP\_FC\_REASON\_RECLLEN\_EXCEEDS\_LOGGER\_BFSZ
- UEP\_FC\_REASON\_RECORD\_BUSY
- UEP\_FC\_REASON\_RECORD\_NOT\_FOUND
- UEP\_FC\_REASON\_REMOTE\_INVREQ
- UEP\_FC\_REASON\_RESTART\_FAILED
- UEP\_FC\_REASON\_REWRITE\_BEFORE\_READ\_UPDATE
- UEP\_FC\_REASON\_RIDFLD\_KEY\_NOT\_RECORD\_KEY
- UEP\_FC\_REASON\_RLS\_DEADLOCK\_DETECTED
- UEP\_FC\_REASON\_RLS\_DISABLED
- UEP\_FC\_REASON\_RLS\_FAILURE
- UEP\_FC\_REASON\_RR\_NOT\_RLS
- UEP\_FC\_REASON\_SECURITY\_FAILURE
- UEP\_FC\_REASON\_SELF\_DEADLOCK\_DETECTED
- UEP\_FC\_REASON\_SERVREQ\_VIOLATION
- UEP\_FC\_REASON\_SHIP
- UEP\_FC\_REASON\_SHIPPED\_SECURITY\_FAILURE
- UEP\_FC\_REASON\_STORE\_FAIL
- UEP\_FC\_REASON\_SUPPRESSED
- UEP\_FC\_REASON\_SYSDERR
- UEP\_FC\_REASON\_TABLE\_FULL
- UEP\_FC\_REASON\_TABLE\_TOKEN\_INVALID
- UEP\_FC\_REASON\_TIMEOUT
- UEP\_FC\_REASON\_TOO\_MANY\_CFDTS\_IN\_UOW
- UEP\_FC\_REASON\_UNKNOWN\_REQID\_ENDBR
- UEP\_FC\_REASON\_UNKNOWN\_REQID\_READNEXT
- UEP\_FC\_REASON\_UNKNOWN\_REQID\_READPREV
- UEP\_FC\_REASON\_UNKNOWN\_REQID\_RESETBR
- UEP\_FC\_REASON\_UPDATE\_NOT\_AUTHORISED

#### **UEP\_FC\_EXIT\_TOKEN**

Address of the 4-byte token passed from XFCFRIN.

#### **Return codes**

##### **UERCNORM**

Continue processing.

##### **UERCPURG**

Task purged during XPI call.

#### **XPI calls**

All can be used.

#### **API and SPI calls**

None can be used.

## **File control EXEC interface API exits XFCREQ and XFCREQC**

The XFCREQ exit allows you to intercept a file control application programming interface (API) request before any action has been taken on it by file control. The XFCREQC exit allows you to intercept a file control API request after file control has completed its processing.

**Note:** For information about the XFCAREQ and XFCAREQC exits that are invoked for file control SPI requests, see “File control EXEC interface SPI exits XFCAREQ and XFCAREQC” on page 98.

## Important

The XFCREQ and XFCREQC exits are not invoked, on the target region, for function-shipped requests. That is, if a file control API request is function-shipped to a remote region, the exits are not invoked on the remote region. To intercept a function-shipped file control API request on the target region, use the XFCFRIN exit—see “File control domain exits, XFCFRIN and XFCFROUT” on page 72.

The file control API commands intercepted are:

- READ
- WRITE
- REWRITE
- DELETE
- UNLOCK
- STARTBR
- READNEXT
- READPREV
- ENDBR
- RESETBR.

The XFCREQ and XFCREQC exits can be written only in assembler language.

Using XFCREQ, you can:

- Analyze the request, to determine its type, the keywords specified, and their values.
- Modify values specified by the request before the command is executed.
- Set return codes to specify that either:
  - CICS should continue with the (possibly modified) request.
  - CICS should bypass the request. (Note that if you set this return code, you must also set up return codes for the EXEC interface block (EIB), as if you had processed the request yourself.)

Using XFCREQC, you can:

- Analyze the request, to determine its type, the keywords specified, and their values.
- Set return codes for the EIB.

Both exits are passed nine parameters as follows:

- The address of the command-level parameter structure
- The address of a token (UEPFCTOK) used to pass 4 bytes of data from XFCREQ to XFCREQC
- The addresses of copies of four pieces of return code and resource information from the EIB
- The address of a token (UEPTSTOK) that is valid throughout the life of a task
- The address of a recursion count field

- The address of a 16-byte area that is used if the request has been function shipped.

## The command-level parameter structure

The command-level parameter structure consists of a series of addresses. The first address points to the EXEC interface descriptor (EID), which consists of a bit string that describes the type of request and identifies each keyword specified with the request. The remaining addresses point to pieces of data associated with the request. (For example, the second address always points to the file name.)

**Only the first 8 addresses and the last address can be referenced by the user exit. The ninth through eleventh addresses are reserved for CICS internal use.**

You can examine the EID to determine the type of request and the keywords specified. You can examine the other parameters in the list to determine the values of the keywords. You can also modify values of keywords specified on the request. (For example, you could change the name of the file involved in the request.)

## End of parameter list indicator

The high-order bit is set on in the last address set in the parameter list to indicate that it is the last one in the list. On return from your user exit program, CICS scans the parameter list for the high-order bit to find the last parameter. Therefore, if you modify the length of the parameter list, you must also reset the high-order bit to indicate which is the new last address.

The original parameter list, as it was before XFCREQ was invoked, is restored after the completion of XFCREQC. It follows that the execution diagnostic facility (EDF) displays the original command before **and** after execution. **EDF does not display any changes made by the exit.**

### *The UEPCLPS exit-specific parameter:*

The UEPCLPS exit-specific parameter is included in both exit XFCREQ and exit XFCREQC. It is the address of the command-level parameter structure. The command-level parameter structure contains 12 addresses, FC\_ADDR0 through FC\_ADDRB. It is defined in the DSECT FC\_ADDR\_LIST, which you should copy into your exit program by including the statement COPY DFHFCEDES.

The command-level parameter list is made up as follows:

#### **FC\_ADDR0**

is the address of a 9-byte area called the EID, which is made up as follows:

- **FC\_GROUP**
- **FC\_FUNCT**
- **FC\_BITS1**
- **FC\_BITS2**
- **FC\_EIDOPT5**
- **FC\_EIDOPT6**
- **FC\_EIDOPT7**
- **FC\_EIDOPT8**

The name of the DSECT mapping the EID is FC\_EID.

## FC\_GROUP

Always X'06', indicating that this is a file control request.

## FC\_FUNCT

One byte that defines the type of request:

- X'02' READ
- X'04' WRITE
- X'06' REWRITE
- X'08' DELETE
- X'0A' UNLOCK
- X'0C' STARTBR
- X'0E' READNEXT
- X'10' READPREV
- X'12' ENDBR
- X'14' RESETBR

## FC\_BITS1

Existence bits that define which keywords that contain values were specified. To obtain the value associated with a keyword, you need to use the appropriate address from the command-level parameter structure. Before using this address, you must check the associated existence bit. If the existence bit is set off, the keyword was not specified in the request and the address should not be used.

- X'80' Set if the request contains the keyword FILE. If set, **FC\_ADDR1** is meaningful.
- X'40' Set if the request contains any of the keywords INTO, SET, or FROM. If set, **FC\_ADDR2** is meaningful.
- X'20' Set if the request specifies LENGTH or NUMREC, or if a STARTBR, RESETBR, or ENDBR request specifies REQID. If set, **FC\_ADDR3** is meaningful.
- X'10' Set if the request specifies RIDFLD. If set, **FC\_ADDR4** is meaningful.
- X'08' Set if the request specifies KEYLENGTH. If set, **FC\_ADDR5** is meaningful.
- X'04' Set if the request is READNEXT or READPREV and specifies REQID. If set, **FC\_ADDR6** is meaningful.
- X'02' Set if the request specifies SYSID. If set, **FC\_ADDR7** is meaningful.
- X'01' Not used by file control.

## FC\_BITS2

Second set of existence bits.

- X'20' Set if the request specifies TOKEN. If set, **FC\_ADDRB** is meaningful.

## FC\_EIDOPT5

Indicates whether certain keywords that do not take values were specified on the request.

- X'04' MASSINSERT specified.
- X'02' RRN specified.
- X'01' SET (and not INTO) was specified.

**Note:** Your program must test for keywords at the bit level, because there may be more than one of these keywords present.

#### FC\_EIDOPT6

Indicates whether certain keywords that do not take values were specified on the request.

- X'80' RBA specified.
- X'40' GENERIC specified.
- X'20' GTEQ specified.
- X'10' UNCOMMITTED specified.
- X'08' CONSISTENT specified.
- X'04' REPEATABLE specified.
- X'01' NOSUSPEND specified (on READ, READNEXT, READPREV, WRITE, DELETE, or REWRITE).

**Note:**

1. If the read integrity bits (for UNCOMMITTED, CONSISTENT, and REPEATABLE) are off (zero) on the command, the read integrity options specified on the file resource definition are used. If you need to know what these are, you can issue an EXEC CICS INQUIRE FILE command.
2. Your program must test for keywords at the bit level, because there may be more than one of these keywords present.

#### FC\_EIDOPT7

Indicates whether certain keywords that do not take values were specified on the request.

- X'04' UPDATE specified. This setting is meaningful only for READ requests. For other requests, X'04' may or may not be set.
- X'01' Either DEBREC or DEBKEY specified (see **FC\_EIDOPT8**). This setting is meaningful only for READ requests. For other requests, X'01' may or may not be set.

**Note:** Your program must test for keywords at the bit level, because there may be more than one of these keywords present.

#### FC\_EIDOPT8

Indicates whether certain keywords that do not take values were specified on the request.

- X'80' DEBKEY specified.
- X'40' DEBREC specified.
- X'20' TOKEN specified.

**X'08'** XRBA specified. If the XRBA bit is on, FC\_RIDFLD (described in DSECT DFHFCEDS) points to an 8-byte extended relative byte address (XRBA).

**FC\_ADDR1**

is the address of an 8-byte area containing the name specified on the FILE keyword.

**FC\_ADDR2**

is the address of one of the following:

- A 4-byte address returned for SET (if the request is READ, READNEXT, or READPREV, and if **FC\_EIDOPT5** indicates that this is SET).
- Data returned for INTO (if the request is READ, READNEXT, or READPREV, and if **FC\_EIDOPT5** indicates that this is not SET).
- Data from FROM (if the request is WRITE or REWRITE).

**FC\_ADDR3**

is the address of one of the following:

- The halfword value of LENGTH (if the request is READ, WRITE, REWRITE, READNEXT, or READPREV).

**Warning:** For requests that specify INTO, do not change the value of LENGTH to a value greater than that specified by the application. To do so causes a storage overlay in the application.

- The returned halfword value of NUMREC (if the request is DELETE).
- The halfword value of REQID (if the request is STARTBR, RESETBR, or ENDBR).

**FC\_ADDR4**

is the address of an area containing the value of the RIDFLD keyword.

**FC\_ADDR5**

is the address of the halfword value of KEYLENGTH.

**FC\_ADDR6**

is the address of the halfword value of REQID (if the request is READNEXT or READPREV).

**FC\_ADDR7**

is the address of an area containing the value of SYSID.

**FC\_ADDR8**

is the address of a value intended for CICS internal use only. It must not be used.

**FC\_ADDR9**

is the address of a value intended for CICS internal use only. It must not be used.

**FC\_ADDRA**

is the address of a value intended for CICS internal use only. It must not be used.

**FC\_ADDRB**

is the address of the fullword value of TOKEN (if the request is READ, READNEXT, READPREV, REWRITE, DELETE, or UNLOCK).



## Modifying fields in the command-level parameter structure

Some fields that are passed to file control are used as input to the request, some are used as output fields, and some are used for both input and output. The method your user exit program uses to modify a field depends on the usage of the field.

### ***A list of input and output fields:***

The following are always input fields:

- FILE
- FROM
- KEYLENGTH
- REQID
- SYSID

The following are always output fields:

- INTO
- NUMREC
- SET

Whether LENGTH and RIDFLD are input or output fields depends on the request, as shown in Table 4. A dash (—) means that the keyword cannot be specified on the request.

*Table 4. LENGTH and RIDFLD as input and output fields*

<b>Request</b>	<b>LENGTH</b>	<b>RIDFLD</b>
READ	Output	See Note 1.
WRITE	Input	See Note 2.
REWRITE	Input	—
DELETE	—	See Note 3.
UNLOCK	—	—
STARTBR	—	Input
READNEXT	Output	Output
READPREV	Output	Output
ENDBR	—	—
RESETBR	—	Input

### **Note:**

1. Normally, this is an input field. However, if UPDATE is specified and the file is a BDAM file using extended key search, RIDFLD is used for both input and output.
2. The use of RIDFLD on a WRITE request depends on the file type. For a VSAM KSDS or RRDS, or a fixed-format BDAM file, RIDFLD is an input field. For all other file types, it is used either for output only, or for both input and output, and should be treated like an output field.
3. RIDFLD is an input field on DELETE requests that are not preceded by a READ UPDATE. It is not specified on requests that are preceded by a READ UPDATE.

**Modifying input fields:** The correct method of modifying an input field is to create a new copy of it, and to change the address in the command-level parameter list to point to your new data.

**Note:** You must never modify an input field by altering the data that is pointed to by the command-level parameter list. To do so would corrupt storage belonging to the application program and would cause a failure when the program attempted to reuse the field.

**Modifying output fields:** The technique described in “Modifying input fields” is not suitable for modifying output fields. (The results would be returned to the new area instead of the application’s area, and would be invisible to the application.)

An output field is modified by altering the data that is pointed to by the command-level parameter list. In the case of an output field, you can modify the application’s data in place, because the application is expecting the field to be modified anyway.

**Modifying fields used for both input and output:** An example of a field that is used for both input and output is LENGTH on a READ request that specifies INTO. You can treat such fields in the same way as output fields, and they are considered to be the same.

## Modifying the EID

It is not possible to modify the EID to make major changes to requests. It is not possible, for example, to change a WRITE request to a READ request.

However, you can make minor changes to requests, such as to turn on the existence bit for SYSID so that the request can be changed into one that is shipped to a remote system.

The list that follows shows the bits in the EID that can be modified. Any attempt to modify any other part of the EID is ignored.

### FC\_BITS1

- X'20'** The existence bit for LENGTH, NUMREC, or (if the request is STARTBR, RESETBR, or ENDBR) REQID.
- X'08'** The existence bit for KEYLENGTH.
- X'04'** The existence bit for REQID if the request is READNEXT or READPREV.
- X'02'** The existence bit for SYSID.

### FC\_BITS2

- X'20'** Token specified.

### FC\_EIDOPT5

- X'04'** MASSINSERT specified.

### FC\_EIDOPT6

- X'40'** GENERIC specified.
- X'20'** GTEQ specified.
- X'10'** UNCOMMITTED specified.
- X'08'** CONSISTENT specified.

- X'04' REPEATABLE specified.
- X'02' UPDATE specified on READNEXT or READPREV.
- X'01' NOSUSPEND specified (on READ, READNEXT, READPREV, WRITE, DELETE, or REWRITE).

Bits in the EID should be modified in place. You should not modify the pointer to the EID: any attempt to do so is ignored by CICS.

The EID is reset to its original value before return to the application program. That is, changes made to the EID are retained for the duration of the file control request only.

If more than one of UNCOMMITTED, CONSISTENT, or REPEATABLE is specified, CONSISTENT takes precedence over UNCOMMITTED, and REPEATABLE takes precedence over CONSISTENT and UNCOMMITTED.

**Example of modifying read integrity bits:** You might want all RLS read requests from all programs against a specific file to specify CONSISTENT read. You could code a user exit program that turns on the bit for CONSISTENT and turns off the other two read integrity bits in all requests to the file. You could partially achieve this effect by specifying CONSISTENT on the FILE definition. However, that would only override requests that did not explicitly specify a level of read integrity. Using a global user exit program for this purpose also overrides programs that explicitly specify UNCOMMITTED or REPEATABLE.

**Warnings:**

1. If a global user exit program changes a file request to request a higher level of read integrity (for example, it changes the request from UNCOMMITTED to REPEATABLE), this could cause CICS either to acquire extra read locks, or to keep its read locks for a longer period of time. This may degrade system throughput, by causing other transactions to wait, or introduce deadlocks.
2. If a global user exit program changes the request to one that requests a lower level of read integrity (for example, it changes the request from REPEATABLE to UNCOMMITTED), this could cause application logic errors to occur in the program that originated the request. The errors could occur because the application program may be relying on the record to remain unchanged while it reads a series of other, related, records. This can be guaranteed with REPEATABLE, but not if the option is changed to UNCOMMITTED.
3. Your user exit program is prevented from making major changes to the EID. However, you must take great care when making the minor modifications that **are** permitted. For instance, it is possible to change a DELETE into a GENERIC DELETE, but to make such a change may be dangerous.

**Use of the task token UEPTSTOK**

UEPTSTOK provides the address of a 4-byte area that you can use to pass information between successive file control requests in the same task. (By contrast, UEPFCTOK is usable only for the duration of a single file control request, because its contents may be destroyed at the end of the request.) For example, if you need to pass information between successive invocations of the XFCREQ exit, UEPTSTOK provides a means of doing this.

## Use of the parameter UEPFSHIP

UEPFSHIP contains the address of a 16-byte area. This area consists of 4 characters, followed by 3 fullwords. If the first byte contains 'Y', this request has been function shipped to this region. In this case, if your exit program wants to bypass file control (by setting a return code of UERCBYP), it must set the 3 fullwords as follows:

### Fullword 1

The length of the buffer area

### Fullword 2

The length of the record

### Fullword 3

The length of the modified RIDFLD.

Doing this ensures that the data and RIDFLD are correctly shipped back.

## The EIB

Copies of EIBRSRCE, EIBRCODE, EIBRESP, and EIBRESP2 are passed to the exit, so that you can:

- Modify or set completion and resource information in XFCREQ and XFCREQC
- Examine completion and resource information in XFCREQC.

You can update the copies of EIBRSRCE, EIBRCODE, EIBRESP, and EIBRESP2 that you are given in the parameter list. File Control copies your values into the real EIB after the completion of XFCREQC; or if you specify a return code of 'bypass' in XFCREQ.

You must set valid file control responses. You must set all three of EIBRCODE, EIBRESP, and EIBRESP2 to a consistent set of values, such as would be set by File Control to describe a valid completion. **File Control does not police the consistency of EIBRCODE, EIBRESP, and EIBRESP2.** To aid you in setting the values of EIBRCODE, EIBRESP, and EIBRESP2, the values used by File Control are specified in DFHFCEDS.

## Example of how XFCREQ and XFCREQC can be used

XFCREQ and XFCREQC can be used for a variety of purposes. One example of a possible use is given below.

In this example, XFCREQ and XFCREQC are used to obtain a record containing compressed data, to decompress the data, and to return it to the area specified by the user program as INTO. The example shows only the capabilities of the exits; it is not intended to indicate an ideal way of achieving the function.

### In XFCREQ:

1. Issue an EXEC CICS GETMAIN to obtain an area large enough to hold the decompressed data.
2. Change the INTO pointer to point to this new area, so that File Control uses it when it processes the request. (The decompressed data is copied to the *user's* INTO area, and the INTO pointer reset, before return to the application program—see stages 4 on page 95 and 7 on page 95 of the processing to be done by XFCREQC.)
3. Set UEPFCTOK to be the address of the new area so that XFCREQC can also use this area.
4. Return to CICS.

### In XFCREQC:

1. Check 'UEPRCODE' to make sure that the file control request completed without error.
2. Use UEPFCTOK to find the address of the area. This area now holds the compressed data.
3. Decompress the data in place.
4. Copy the data from the new area to the user's INTO area. Use the user-specified LENGTH (from the command-level parameter list) to ensure that the data fits and that the copy does not cause a storage violation.
5. Set 'LENGERR' in UEPRESP, UEPRESP2, and UEPRCODE if the data does not fit.
6. Use EXEC CICS FREEMAIN to free the work area pointed to by UEPFCTOK.
7. At this point the command-level parameter list points to the now free area as the address for INTO. This is not a problem, because after completion of XFCREQC File Control restores this pointer to point to the area supplied by the user program.
8. Return to CICS.

### Exit XFCREQ

#### When invoked

Before CICS processes a file control API request.

**Note:** The exit is not invoked, on the target region, for function-shipped requests.

#### Exit-specific parameters

##### UEPCLPS

Address of the command-level parameter structure. See "The UEPCLPS exit-specific parameter" on page 87.

##### UEPFCTOK

Address of the 4-byte token to be passed to XFCREQC. This allows you, for example, to pass a work area to exit XFCREQC.

##### UEPRCODE

Address of a 6-byte hexadecimal copy of the EIB return code 'EIBRCODE'. For details of EIB return codes, refer to EIB fields, in the *CICS Application Programming Reference* manual.

##### UEPRESP

Address of a 4-byte binary copy of the EIB response code 'EIBRESP'.

##### UEPRESP2

Address of a 4-byte binary copy of the EIB response code 'EIBRESP2'.

##### UEPTSTOK

Address of a 4-byte token that is valid throughout the life of a task. See "Use of the task token UEPTSTOK" on page 93.

##### UEPRECUR

Address of a halfword recursion counter. The counter is set to 0 when the exit is first invoked, and is incremented for each recursive call.

**UEPFSHIP**

Address of a 16 byte area. See “Use of the parameter UEPFSHIP” on page 94.

**UEPRSRCE**

Address of an 8-character copy of the EIB resource value, EIBRSRCE.

**Return codes****UERCNORM**

Continue processing.

**UERCBYBYP**

The file control EXEC interface program should ignore this request.

**UERCPURG**

Task purged during XPI call.

**XPI calls**

All can be used.

Although the exit permits the use of XPI GETMAIN and FREEMAIN calls, we recommend that you use the EXEC CICS GETMAIN and FREEMAIN commands instead.

**API and SPI calls**

All can be used, except for:  
EXEC CICS SHUTDOWN  
EXEC CICS XCTL

**Note:**

1. Take care when issuing recursive commands not to cause a loop. For example, it is your responsibility to avoid entering a loop when a file control request is issued from the XFCREQ exit. Use of the recursion counter UEPRECUR is recommended.
2. Exit programs that issue EXEC CICS commands must first address the EIB. See “Using CICS services” on page 4.
3. Exit programs that issue EXEC CICS commands, and that use the DFHEIENT macro, should use the DFHEIRET macro to set a return code and return to CICS. See “Returning values to CICS” on page 10.

**Exit XFCREQC****When invoked**

After a file control API request has completed, and before return from the file control EXEC interface program.

**Note:** The exit is not invoked, on the target region, for function-shipped requests.

**Exit-specific parameters****UEPCLPS**

Address of the command-level parameter structure. See “The UEPCLPS exit-specific parameter” on page 87.

**UEPFCTOK**

Address of the 4 byte token passed from XFCREQ.

**UEPRCODE**

Address of a 6-byte hexadecimal copy of the EIB return code

'EIBRCODE'. For details of EIB return codes, refer to EIB fields, in the *CICS Application Programming Reference* manual.

#### **UEPRES**

Address of a 4-byte binary copy of the EIB response code 'EIBRESP'.

**Note:** If the file that has just been accessed is remote, the addressed field contains zeros (even if UEPRCODE is non-zero).

#### **UEPRES2**

Address of a 4-byte binary copy of the EIB response code 'EIBRESP2'.

**Note:** If the file that has just been accessed is remote, the addressed field contains zeros (even if UEPRCODE is non-zero).

#### **UEPTSTOK**

Address of a 4-byte token that is valid throughout the life of a task. See "Use of the task token UEPTSTOK" on page 93.

#### **UEPRECUR**

Address of a halfword recursion counter. The counter is set to 0 when the exit is first invoked, and is incremented for each recursive call.

#### **UEPRSRCE**

Address of an 8-character copy of the EIB resource value, EIBRSRCE.

#### **Return codes**

##### **UERCNORM**

Continue processing.

##### **UERCPURG**

Task purged during XPI call.

#### **XPI calls**

All can be used.

Although the exit permits the use of XPI GETMAIN and FREEMAIN calls, we recommend that you use the EXEC CICS GETMAIN and FREEMAIN commands instead.

#### **API and SPI calls**

All can be used, except for:  
EXEC CICS SHUTDOWN  
EXEC CICS XCTL

#### **Note:**

1. Take care when issuing recursive commands not to cause a loop. For example, it is your responsibility to avoid entering a loop when a file control request is issued from the XFCREQC exit. Use of the recursion counter UEPRECUR is recommended.
2. Exit programs that issue EXEC CICS commands must first address the EIB. See "Using CICS services" on page 4.

3. Exit programs that issue EXEC CICS commands, and that use the DFHEIENT macro, should use the DFHEIRET macro to set a return code and return to CICS. See “Returning values to CICS” on page 10.

### Example program

CICS supplies, in CICSTS32.CICS.SDFHSAMP, an example program, DFH\$XTSE, that shows how to modify fields in the command-level parameter structure passed to EXEC interface exits. DFH\$XTSE is listed on page Appendix F, “The example program for the XTSEREQ global user exit, DFH\$XTSE,” on page 877.

## File control EXEC interface SPI exits XFCAREQ and XFCAREQC

The XFCAREQ exit allows you to intercept a file control system programming interface (SPI) request before any action has been taken on it by file control. The XFCAREQC exit allows you to intercept the response after a file control SPI request has completed.

**Note:** For information about the XFCREQ and XFCREQC exits that are invoked for file control API requests, see “File control EXEC interface API exits XFCREQ and XFCREQC” on page 85.

The file control SPI requests intercepted are:

- EXEC CICS INQUIRE FILE
- EXEC CICS SET FILE.

Using XFCAREQ, you can:

- Analyze the SPI parameter list (function, keywords, argument values, and responses)
- Modify any input parameter prior to execution of the request
- Prevent execution of a request and set appropriate responses.

Using XFCAREQC, you can:

- Analyze the SPI parameter list
- Modify any output parameter value and set responses after execution.

You can also:

- Pass data between your XFCAREQ and XFCAREQC exit programs when they are invoked for the same request.
- Pass data between your file control exit programs when they are invoked within the same task. You can pass data between successive invocations of XFCAREQ and XFCAREQC and also between invocations of other EXEC-enabled user exits.

If you make changes to file states (that is, if you open, close, enable, or disable a file) it is possible that exits in the file state change program (XFCSREQ and XFCSREQC) could modify situations set up by XFCAREQ. Therefore you must consider the order in which the exits are invoked. If all four exits are enabled, the order of invocation is as follows:

- For the SET FILE command:
  1. XFCAREQ
  2. XFCSREQ
  3. XFCSREQC



4. XFCAREQC
- For the INQUIRE FILE command, only the XFCAREQ and XFCAREQC exits are invoked:
    1. XFCAREQ
    2. XFCAREQC

## Exit XFCAREQ

### When invoked

Before CICS processes a file control SPI request.

### Exit-specific parameters

#### UEPCLPS

Address of a copy of the SPI command parameter list. See “The command-level parameter structure” on page 101.

#### UEPFATOK

Address of a 4-byte area that can be used to pass information between XFCAREQ and XFCAREQC on a single file control SPI request.

#### UEPRCODE

Address of a 6-byte hexadecimal copy of the EIB return code EIBRCODE. For details of EIB return codes, see EIB fields, in the *CICS Application Programming Reference* manual.

#### UEPRES

Address of a 4-byte binary copy of the EIB response code EIBRESP.

#### UEPRES2

Address of a 4-byte binary copy of the EIB response code EIBRESP2.

#### UEPTSTOK

Address of a 4-byte token which can be used to pass information between successive file control requests within the same task (for example, between successive invocations of the XFCAREQC exit).

#### UEPRECUR

Address of a halfword recursion counter. The counter is set to zero when the exit is first invoked and is incremented for each recursive call.

### Return codes

#### UERCBYP

Bypass this request.

#### UERCNORM

Continue processing.

#### UEPCPURG

Task purged during XPI call.

### XPI commands

All can be used.

### API and SPI commands

All can be used, except for:  
 EXEC CICS SHUTDOWN  
 EXEC CICS XCTL

**Note:** Take care when using recursive commands. For example, you must avoid entering a loop when issuing a file control SPI request from the XFCAREQ exit. Use of the recursion counter UEPRECUR is recommended.

## Exit XFCAREQC

### When invoked

After a file control SPI request has completed, before return from the file control SPI EXEC interface program.

### Exit specific parameters:

#### UEPCLPS

Address of a copy of the API command parameter list. See “The command-level parameter structure” on page 101.

#### UEPFATOK

Address of a 4-byte area that can be used to pass information between XFCAREQ and XFCAREQC on a single file control SPI request.

#### UEPRCODE

Address of a 6-byte hexadecimal copy of the EIB return code EIBRCODE. For details of EIB return codes, see EIB fields, in the *CICS Application Programming Reference* manual.

#### UEPRES

Address of a 4-byte binary copy of the EIB response code EIBRESP.

#### UEPRES2

Address of a 4-byte binary copy of the EIB response code EIBRESP2.

#### UEPTSTOK

Address of a 4-byte token which can be used to pass information between successive file control requests within the same task (for example, between successive invocations of the XFCAREQC exit).

#### UEPRECUR

Address of a halfword recursion counter. The counter is set to zero when the exit is first invoked and is incremented for each recursive call.

### Return codes

#### UERCNORM

Continue processing.

#### UERCPURG

Task purged during XPI call.

### XPI commands

All can be used.

### API and SPI commands

All can be used, except for:

EXEC CICS SHUTDOWN

EXEC CICS XCTL

You can update the copies of EIBRCODE, EIBRESP, and EIBRESP2 that you are given in the parameter list. If you update the values, file control copies the new

values into the application program's EXEC interface block (EIB) after the completion of XFCAREQC or if you specify a return code of UERCBYP in XFCAREQ.

You must set valid file control responses. You must set all three of EIBRCODE, EIBRESP, and EIBRESP2 to a consistent set of values, such as would be set by file control to describe a valid completion. CICS does not check the consistency of the values you set. If EIBRCODE is set to a non-zero value and EIBRESP is set to zero, CICS overrides EIBRESP with a non-zero value. To help you set values for EIBRCODE, EIBRESP, and EIBRESP2, the values used by file control for SPI requests are specified in DSECT DFHFAUED.

**Note:** Take care when using recursive commands. For example, you must avoid entering a loop when issuing a file control SPI request from the XFCAREQ exit. Use of the recursion counter UEPRECUR is recommended.

## The command-level parameter structure

The command-level parameter structure consists of a series of addresses. The first address points to the EXEC interface descriptor (EID), which consists of a bit string that describes the type of request and identifies each keyword specified with the request. The remaining addresses point to pieces of data associated with the request.

You can examine the EID to determine the type of request and the keywords specified. You can examine the other parameters in the list to determine the values of the keywords. You can also modify values of keywords specified on the request.

**Note:** The relationship between arguments, keywords, data types, and input/output types on the file control SPI commands is summarized in the following tables:

- For INQUIRE FILE, see Table 5 on page 107.
- For SET FILE, see Table 6 on page 108.

### *The UEPCLPS exit-specific parameter:*

The UEPCLPS exit-specific parameter is passed to both XFCAREQ and XFCAREQC. It is the address of the command-level parameter structure. The command-level parameter list contains 59 addresses, FCIS\_ADDR0 through FCIS\_ADDR58. These are described in DSECT DFHFAUED, which you should copy into your program by including the statement COPY DFHFAUED.

The command-level parameter list is made up as follows:

#### **FCIS\_ADDR0**

is the address of an 13-byte area called the EID which is made up as follows:

- **FCIS\_GROUP**
- **FCIS\_FUNCT**
- **FCIS\_EIDOPT2**
- **FCIS\_EIDOPT3**
- **FCIS\_EIDOPT4**
- **FCIS\_BITS1**
- **FCIS\_BITS2**
- **FCIS\_BITS3**

- **FCIS\_BITS4**
- **FCIS\_BITS5**
- **FCIS\_BITS6**
- **FCIS\_BITS7**
- **FCIS\_BITS8**

**FCIS\_GROUP**

Always X'4C', indicating that this is a file control SPI request.

**FCIS\_FUNCT**

One byte that defines the type of request:

X'02' INQUIRE FILE

X'04' SET FILE.

**FCIS\_EIDOPT2**

Not used by file control.

**FCIS\_EIDOPT3**

Not used by file control.

**FCIS\_EIDOPT4**

Not used by file control.

**FCIS\_BITS1**

Existence bits which specify which arguments were specified. To obtain the argument associated with a keyword, you need to obtain the appropriate address from the command-level parameter structure. Before using this address you must check the associated existence bit. If the existence bit is set off, the argument was not specified in the request and the address should not be used.

**X'80'** Set if the request contains an argument for the FILE keyword. If set, FCIS\_ADDR1 is meaningful.

**X'40'** Set if the request contains an argument for the DSNAME keyword. If set, FCIS\_ADDR2 is meaningful.

**X'20'** Set if the request contains an argument for the FWDRECSTATUS keyword. If set, FCIS\_ADDR3 is meaningful.

**X'10'** Set if the request contains an argument for the STRINGS keyword. If set, FCIS\_ADDR4 is meaningful.

**X'08'** Set if the request contains an argument for the BASEDSNAME keyword. If set, FCIS\_ADDR5 is meaningful.

**X'04'** Set if the request contains an argument for the LSRPOOLID keyword. If set, FCIS\_ADDR6 is meaningful.

**X'02'** Set if the request contains an argument for the READ keyword. If set, FCIS\_ADDR7 is meaningful.

**X'01'** Set if the request contains an argument for the UPDATE keyword. If set, FCIS\_ADDR8 is meaningful.

**FCIS\_BITS2**

Existence bits which specify which arguments were specified. The comments below FCIS\_BITS1 also apply to FCIS\_BITS2.

**X'80'** Set if the request contains an argument for the BROWSE keyword. If set, FCIS\_ADDR9 is meaningful.

- X'40'** Set if the request contains an argument for the ADD keyword. If set, FCIS\_ADDR10 is meaningful.
- X'20'** Set if the request contains an argument for the DELETE keyword. If set, FCIS\_ADDR11 is meaningful.
- X'10'** Set if the request contains an argument for the DISPOSITION keyword. If set, FCIS\_ADDR12 is meaningful.
- X'08'** Set if the request contains an argument for the EMPTYSTATUS keyword. If set, FCIS\_ADDR13 is meaningful.
- X'04'** Set if the request contains an argument for the OPENSTATUS keyword. If set, FCIS\_ADDR14 is meaningful.
- X'02'** Set if the request contains an argument for the ENABLESTATUS keyword. If set, FCIS\_ADDR15 is meaningful.
- X'01'** Set if the request contains an argument for the RECOVSTATUS keyword. If set, FCIS\_ADDR16 is meaningful.

### **FCIS\_BITS3**

Existence bits which specify which arguments were specified. The comments below FCIS\_BITS1 also apply to FCIS\_BITS3.

- X'80'** Set if the request contains an argument for the ACCESSMETHOD keyword. If set, FCIS\_ADDR17 is meaningful.
- X'40'** Set if the request contains an argument for the TYPE keyword. If set, FCIS\_ADDR18 is meaningful.
- X'20'** Set if the request contains an argument for the OBJECT keyword. If set, FCIS\_ADDR19 is meaningful.
- X'10'** Set if the request contains an argument for the REMOTESYSTEM keyword. If set, FCIS\_ADDR20 is meaningful.
- X'08'** Set if the request contains an argument for the REMOTENAME keyword. If set, FCIS\_ADDR21 is meaningful.
- X'04'** Set if the request contains an argument for the RECORDFORMAT keyword. If set, FCIS\_ADDR22 is meaningful.
- X'02'** Set if the request contains an argument for the BLOCKFORMAT keyword. If set, FCIS\_ADDR23 is meaningful.
- X'01'** Set if the request contains an argument for the KEYLENGTH keyword. If set, FCIS\_ADDR24 is meaningful.

### **FCIS\_BITS4**

Existence bits which specify which arguments were specified. The comments below FCIS\_BITS1 also apply to FCIS\_BITS4.

- X'80'** Set if the request contains an argument for the KEYPOSITION keyword. If set, FCIS\_ADDR25 is meaningful.
- X'40'** Set if the request contains an argument for the RECORDSIZE keyword. If set, FCIS\_ADDR26 is meaningful.
- X'20'** Set if the request contains an argument for the RELTYPE keyword. If set, FCIS\_ADDR27 is meaningful.

- X'10'** Set if the request contains an argument for the EXCLUSIVE keyword. If set, FCIS\_ADDR28 is meaningful.
- X'08'** Set if the request contains an argument for the BLOCKKEYLEN keyword. If set, FCIS\_ADDR29 is meaningful.
- X'04'** Set if the request contains an argument for the BLOCKSIZE keyword. If set, FCIS\_ADDR30 is meaningful.
- X'02'** Not used by file control.
- X'01'** Not used by file control.

#### **FCIS\_BITS5**

Existence bits which specify which arguments were specified. The comments below FCIS\_BITS1 also apply to FCIS\_BITS5.

- X'80'** Set if the request contains an argument for the TABLE keyword. If set, FCIS\_ADDR33 is meaningful.
- X'40'** Set if the request contains an argument for the MAXNUMRECS keyword. If set, FCIS\_ADDR34 is meaningful.
- X'20'** Set if the request contains an argument for the READINTEG keyword. If set, FCIS\_ADDR35 is meaningful.
- X'10'** Set if the request contains an argument for the RLSACCESS keyword. If set, FCIS\_ADDR36 is meaningful.
- X'08'** Not used by file control.
- X'04'** Not used by file control.
- X'02'** Not used by file control.
- X'01'** Not used by file control.

#### **FCIS\_BITS6**

Specifies whether certain keywords were specified on the File control SPI command.

- X'80'** Set if the request contains the START keyword.
- X'40'** Set if the request contains the NEXT keyword.
- X'20'** Set if the request contains the END keyword.
- X'10'** Set if the request contains the WAIT keyword.
- X'08'** Set if the request contains the NOWAIT keyword.
- X'04'** Set if the request contains the FORCE keyword.
- X'02'** Set if the request contains the ENABLED keyword.
- X'01'** Set if the request contains the DISABLED keyword.

#### **FCIS\_BITS7**

Specifies whether certain keywords were specified on the File control SPI command. Also contains the existence bit for JOURNALNUM.

- X'80'** Set if the request contains the OPEN keyword.
- X'40'** Set if the request contains the CLOSED keyword.
- X'20'** Set if the request contains the EMPTY keyword.
- X'10'** Set if the request contains an argument for the JOURNALNUM keyword. If set, FCIS\_ADDR52 is meaningful.

- X'08' Set if the request contains the LOADTYPE keyword.
- X'04' Set if the request contains the POOL keyword.
- X'02' Set if the request contains the TABLENAME keyword.
- X'01' Set if the request contains the UPDATEMODEL keyword.

**FCIS\_BITS8**

- X'80' Set if the request contains the REMOTETABLE keyword.
- X'40' Set if the request contains the RBATYPE keyword.
- X'20' Not used by file control.
- X'10' Not used by file control.
- X'08' Not used by file control.
- X'04' Not used by file control.
- X'02' Not used by file control.
- X'01' Not used by file control.

**FCIS\_ADDR1**

is the address of an 8-byte area containing the name from FILE.

**FCIS\_ADDR2**

is the address of a 44-byte area containing the name from DSNAME.

**FCIS\_ADDR3**

is the address of a 4-byte area containing the CVDA from FWDRECOVSTATUS.

**FCIS\_ADDR4**

is the address of a 4-byte area containing the data from STRINGS.

**FCIS\_ADDR5**

is the address of a 44-byte area containing the name from BASEDSNAME.

**FCIS\_ADDR6**

is the address of a 4-byte area containing the data from LSRPOOLID.

**FCIS\_ADDR7**

is the address of a 4-byte area containing the CVDA from READ.

**FCIS\_ADDR8**

is the address of a 4-byte area containing the CVDA from UPDATE.

**FCIS\_ADDR9**

is the address of a 4-byte area containing the CVDA from BROWSE.

**FCIS\_ADDR10**

is the address of a 4-byte area containing the CVDA from ADD.

**FCIS\_ADDR11**

is the address of a 4-byte area containing the CVDA from DELETE.

**FCIS\_ADDR12**

is the address of a 4-byte area containing the CVDA from DISPOSITION.

**FCIS\_ADDR13**

is the address of a 4-byte area containing the CVDA from EMPTYSTATUS.

**FCIS\_ADDR14**

is the address of a 4-byte area containing the CVDA from OPENSTATUS.

**FCIS\_ADDR15**  
is the address of a 4-byte area containing the CVDA from ENABLESTATUS.

**FCIS\_ADDR16**  
is the address of a 4-byte area containing the CVDA from RECOVSTATUS.

**FCIS\_ADDR17**  
is the address of a 4-byte area containing the CVDA from ACCESSMETHOD.

**FCIS\_ADDR18**  
is the address of a 4-byte area containing the CVDA from TYPE.

**FCIS\_ADDR19**  
is the address of a 4-byte area containing the CVDA from OBJECT.

**FCIS\_ADDR20**  
is the address of a 4-byte area containing the name from REMOTESYSTEM.

**FCIS\_ADDR21**  
is the address of an 8-byte area containing the name from REMOTENAME.

**FCIS\_ADDR22**  
is the address of a 4-byte area containing the CVDA from RECORDFORMAT.

**FCIS\_ADDR23**  
is the address of a 4-byte area containing the CVDA from BLOCKFORMAT.

**FCIS\_ADDR24**  
is the address of a 4-byte area containing the CVDA from KEYLENGTH.

**FCIS\_ADDR25**  
is the address of a 4-byte area containing the data from KEYPOSITION.

**FCIS\_ADDR26**  
is the address of a 4-byte area containing the data from RECORDSIZE.

**FCIS\_ADDR27**  
is the address of a 4-byte area containing the CVDA from RELTYPE.

**FCIS\_ADDR28**  
is the address of a 4-byte area containing the CVDA from EXCLUSIVE.

**FCIS\_ADDR29**  
is the address of a 4-byte area containing the data from BLOCKKEYLEN.

**FCIS\_ADDR30**  
is the address of a 4-byte area containing the data from BLOCKSIZE.

**FCIS\_ADDR31**  
is not used by file control.

**FCIS\_ADDR32**  
is the address of a 4-byte area containing the data from BUSY.

**FCIS\_ADDR33**  
is the address of a 4-byte area containing the CVDA from TABLE.

**FCIS\_ADDR34**  
is the address of a 4-byte area containing the data from MAXNUMRECS.

**FCIS\_ADDR35**  
is the address of a 4-byte area containing the CVDA from READINTEG.

**FCIS\_ADDR36**  
is the address of a 4-byte area containing the CVDA from RLSACCESS.



**FCIS\_ADDR37 to FCIS\_ADDR51**  
are not used by file control.

**FCIS\_ADDR52**  
is the address of a 4-byte area containing the data from JOURNALNUM.

**FCIS\_ADDR53**  
is the address of a 4-byte area containing the data from LOADTYPE.

**FCIS\_ADDR54**  
is the address of a 4-byte area containing the data from CFDTPOOL.

**FCIS\_ADDR55**  
is the address of a 4-byte area containing the data from TABLENAME.

**FCIS\_ADDR56**  
is the address of a 4-byte area containing the data from UPDATEMODEL.

**FCIS\_ADDR57**  
is the address of a 4-byte area containing the data from REMOTETABLE.

**FCIS\_ADDR58**  
is the address of a 4-byte area containing the data from RBATYPE.

### **Modifying fields in the command-level parameter structure**

Some fields that are passed to file control SPI requests are used as input to the request and some are used as output to the request. The method that your user exit program uses to modify a field depends on the usage of the field. As a general rule:

- On INQUIRE FILE requests, all fields except FILE are output fields.
- On SET FILE requests, all fields are input fields.

For a full description of the parameters to INQUIRE FILE, see Table 5. For a full description of the parameters to SET FILE, see Table 6 on page 108.

*Table 5. INQUIRE FILE requests. The relationship between arguments, keywords, data types, and input/output types.*

<b>Argument</b>	<b>Keyword</b>	<b>Data Type</b>	<b>Input/Output</b>
Arg1	FILE	CHAR(8)	See note.
Arg2	DSNAME	CHAR(44)	Output
Arg3	FWDRECSTATUS	BIN(31)	Output
Arg4	STRINGS	BIN(31)	Output
Arg5	BASEDSNAME	CHAR(44)	Output
Arg6	LSRPOOLID	BIN(31)	Output
Arg7	READ	BIN(31)	Output
Arg8	UPDATE	BIN(31)	Output
Arg9	BROWSE	BIN(31)	Output
Arg10	ADD	BIN(31)	Output
Arg11	DELETE	BIN(31)	Output
Arg12	DISPOSITION	BIN(31)	Output
Arg13	EMPTYSTATUS	BIN(31)	Output
Arg14	OPENSTATUS	BIN(31)	Output
Arg15	ENABLESTATUS	BIN(31)	Output

Table 5. INQUIRE FILE requests (continued). The relationship between arguments, keywords, data types, and input/output types.

Argument	Keyword	Data Type	Input/Output
Arg16	RECOVSTATUS	BIN(31)	Output
Arg17	ACCESSMETHOD	BIN(31)	Output
Arg18	TYPE	BIN(31)	Output
Arg19	OBJECT	BIN(31)	Output
Arg20	REMOTESYSTEM	CHAR(4)	Output
Arg21	REMOTENAME	CHAR(8)	Output
Arg22	RECORDFORMAT	BIN(31)	Output
Arg23	BLOCKFORMAT	BIN(31)	Output
Arg24	KEYLENGTH	BIN(31)	Output
Arg25	KEYPOSITION	BIN(31)	Output
Arg26	RECORDSIZE	BIN(31)	Output
Arg27	RELTYPE	BIN(31)	Output
Arg28	EXCLUSIVE	BIN(31)	Output
Arg29	BLOCKKEYLEN	BIN(31)	Output
Arg30	BLOCKSIZE	BIN(31)	Output
Arg31	*	*	*
Arg32	BUSY	BIN(31)	Output
Arg33	TABLE	BIN(31)	Output
Arg34	MAXNUMRECS	BIN(31)	Output
Arg35	READINTEG	BIN(31)	Output
Arg36	RLSACCESS	BIN(31)	Output
Arg37 to Arg51	*	*	*
Arg52	JOURNALNUM	BIN(15)	Output
Arg53	LOADTYPE	BIN(31)	Output
Arg54	CEDTPOOL	CHAR(8)	Output
Arg55	TABLENAME	CHAR(8)	Output
Arg56	UPDATEMODEL	BIN(31)	Output
Arg57	REMOTETABLE	BIN(31)	Output
Arg58	RBATYPE	BIN(31)	Output

**Note:** The file parameter on INQUIRE FILE commands is:

- An input field if the request does not specify START, NEXT, or END
- An output field if the request specifies NEXT
- Omitted if the request specifies START or END.

Table 6. SET FILE requests. The relationship between arguments, keywords, data types, and input/output types.

Argument	Keyword	Data Type	Input/Output
Arg1	FILE	CHAR(8)	Input

Table 6. SET FILE requests (continued). The relationship between arguments, keywords, data types, and input/output types.

Argument	Keyword	Data Type	Input/Output
Arg2	DSNAME	CHAR(44)	Input
Arg3	FWDRECSTATUS	BIN(31)	Input
Arg4	STRINGS	BIN(31)	Input
Arg5	*	*	*
Arg6	LSRPOOLID	BIN(31)	Input
Arg7	READ	BIN(31)	Input
Arg8	UPDATE	BIN(31)	Input
Arg9	BROWSE	BIN(31)	Input
Arg10	ADD	BIN(31)	Input
Arg11	DELETE	BIN(31)	Input
Arg12	DISPOSITION	BIN(31)	Input
Arg13	EMPTYSTATUS	BIN(31)	Input
Arg14	OPENSTATUS	BIN(31)	Input
Arg15	ENABLESTATUS	BIN(31)	Input
Arg16	RECOVSTATUS	BIN(31)	Input
Arg17	*	*	*
Arg18	*	*	*
Arg19	*	*	*
Arg20	*	*	*
Arg21	*	*	*
Arg22	*	*	*
Arg23	*	*	*
Arg24	*	*	*
Arg25	*	*	*
Arg26	*	*	*
Arg27	*	*	*
Arg28	EXCLUSIVE	BIN(31)	Input
Arg29	*	*	*
Arg30	*	*	*
Arg31	*	*	*
Arg32	*	*	*
Arg33	TABLE	BIN(31)	Input
Arg34	MAXNUMRECS	BIN(31)	Input
Arg35	READINTEG	BIN(31)	Input
Arg36	RLSACCESS	BIN(31)	Input

**Modifying input fields:** The correct method of modifying an input field is to create a new copy of it, and to change the address in the command-level parameter list to point to your new data.

**Note:** You must never modify an input field by altering the data that is pointed to by the command-level parameter list. To do so would corrupt storage belonging to the application program and would cause a failure when the program attempted to reuse the field.

**Modifying output fields:** The technique described in “Modifying input fields” on page 109 is not suitable for modifying output fields. (The results would be returned to the new area instead of the application’s area, and would be invisible to the application.)

An output field is modified by altering the data that is pointed to by the command-level parameter list. In the case of an output field, you can modify the application’s data in place, because the application is expecting the field to be modified anyway.

## Modifying the EID

It is not possible to modify the EID to make major changes to requests. It is not possible, for example, to change an INQUIRE FILE request to a SET FILE request. However, you can make minor changes to requests, such as to turn on the existence bit for a variable that had not been specified on the current request. The following paragraph lists the bits in the EID that can be modified. Any attempt to modify any other part of the EID is ignored.

Your exit program can modify any bit in FCIS\_BITS1, FCIS\_BITS2, FCIS\_BITS3, FCIS\_BITS4, FCIS\_BITS5, FCIS\_BITS6 and FCIS\_BITS7, *except for*:

- The existence bit for the FILE keyword.
- The bits for the START, NEXT, and END keywords.
- Any bits described as “not used by file control”.
- Any bit corresponding to a keyword that is not applicable to the command being executed. For example, the bit for the CLOSED keyword can be modified on a SET FILE request but not on an INQUIRE FILE request, because CLOSED has meaning only for a SET FILE request. See the descriptions in Table 5 on page 107 and Table 6 on page 108.

Your program can provide its own command-level parameter structure and EID, in which case you should modify UEPCPLPS and TS\_ADDR0 respectively to point to the new structures.

The EID is reset to its original value before return to the application program. That is, changes to the EID are retained for the duration of the file control SPI request only.

**Note:** If you modify the EID, you must be careful not to create inconsistent parameters. For example, if the original request specified SET FILE OPEN and your exit turned on the EID bit for CLOSED, the resulting SET FILE request would specify both OPEN and CLOSED. In this case, the results of the command would be unpredictable.

## Use of the task token UEPTSTOK

UEPTSTOK provides the address of a 4-byte area that you can use to pass information between successive file control requests in the same task. (By contrast, UEPFATOK is usable only for the duration of a single file control request, because its contents may be destroyed at the end of the request.) For example, if you need to pass information between successive invocations of XFCAREQ exit, UEPTSTOK provides a means of doing this.

## Modifying user arguments

User exit programs can modify user arguments as follows:

- For input arguments, your exit program should obtain sufficient storage to hold the modified argument, set up the required value, and set the associated pointer in the parameter list to the address of the newly acquired area.
- For output and input/output arguments, your exit program can update the argument in place, because the area of storage is represented in the application by a variable that is expected to receive a value from CICS.

**Adding user arguments:** Your exit program can add user arguments, provided that it is allowed to modify the corresponding existence bit in the EID. Assuming that the argument to be added does not already exist, your exit program must:

1. Obtain storage for the argument to be added
2. Initialize the storage to the required value
3. Select and set up the appropriate pointer from the parameter list
4. Select and set up the appropriate existence bit in Arg0
5. If necessary, modify the parameter list to reflect the new end-of-list indicator.

**Removing user arguments:** Your exit program can remove user arguments, provided that it is allowed to modify the corresponding existence bit in the EID. Assuming that the argument to be removed exists, your exit program must:

1. Switch the corresponding argument existence bit in Arg0 to zero
2. Modify the parameter list to reflect the new end-of-list indicator.

## File control file state program exits XFCSREQ and XFCSREQC

Two user exits are provided in the file control state program. You can use XFCSREQ, which is invoked **before** a file ENABLE, DISABLE, OPEN, CLOSE, or CANCEL CLOSE request is acted on, to gather information about the state of the file—for example, which file requests (SERVREQs) are valid, which journaling options are set. Based on this information, you can suppress the request, if appropriate. (See return code UERCBYP.)

You can use XFCSREQC, which is invoked **after** the file request has been acted on, to gather information about the data set associated with the file—for example, which recovery options are set. Note that XFCSREQC is invoked even if you have used XFCSREQ to suppress the file request.

For ENABLE, DISABLE, OPEN, and CANCEL CLOSE requests, each exit is invoked only once. However, for CLOSE requests, because a file can be quiesced before actual closure, the exits might be invoked more than once, as described below.

For a single CLOSE request, XFCSREQ and XFCSREQC are invoked more than once if closure is attempted while the file is being accessed by other tasks. For example, the result of a CLOSE NOWAIT command in these circumstances is that XFCSREQ is invoked before the closure is attempted. Because there are still users of the file, the closure is delayed. However, because it specified NOWAIT, the CLOSE request completes, and invokes XFCSREQC with UEPFSRSP set to 'UEFSPEND', meaning closure is pending. When all activity against the file is complete, the file is closed, and XFCSREQ and XFCSREQC are invoked under the task that actually closed it.

For a CLOSE WAIT command, the exits are invoked as follows. XFCSREQ is invoked, the task requests a closure of the file and waits for the closure to happen. When all activity against the file is complete, the file is closed, and XFCSREQ and XFCSREQC are invoked under the task that closed it. Finally, because the closure has now been completed, the task that issued the CLOSE WAIT is resumed, completes its CLOSE request, and invokes XFCSREQC.

A CANCEL CLOSE request is issued by CICS in response to an UNQUIESCE command that cancels a pending QUIESCE command. A QUIESCE data set command immediately sets all files opened against the specified data set as unenabled, to prevent new tasks being allowed access to the data set. The close part of the operation, however, waits until the last user task finishes before a file is actually closed. (This is the same as any close operation against a file.) An UNQUIESCE issued while the close is still waiting causes a CANCEL CLOSE request and the invocation of the XFCSREQ and XFCSREQC exits. Note that a CANCEL CLOSE is issued only for close requests that were initiated by a QUIESCE command, not for any other close requests.

**Note:** There are two occasions when the user exits XFCSREQ and XFCSREQC are not invoked during a close request:

1. On a controlled, non-immediate shutdown of CICS, when CICS closes all files.
2. After loading a user maintained data table. When the data table load has completed the source data set is no longer required. CICS subsequently closes and de-allocates the file, leaving the data table open.

## Exit XFCSREQ

### When invoked

Before a file ENABLE, DISABLE, OPEN, CLOSE, or CANCEL CLOSE is attempted.

**Note:** The exit is not invoked for function-shipped requests.

### Exit-specific parameters

#### UEPFSREQ

Address of a 2-byte field that indicates the type of file request. The first byte contains one of the following values:

#### UEPFSOPN

Open request

#### UEPFSCLS

Close request

#### UEPFSENB

Enable request

#### UEPFSDIS

Disable request

#### UEPFSKAN

Cancel close file request.

If the first byte indicates an open request (UEPFSOPN), the second byte shows the type of open:

#### UEPFSNOP

Normal open

**UEPFSOFB**

Open for backout.

If the first byte indicates a close request (UEPFSCLS), the second byte shows the type of close:

**UEPFSNC**

Normal close

**UEPFSCP**

Close pending

**UEPFSELM**

End of load mode close

**UEPFSIMM**

Immediate close

**UEPFSICP**

Immediate close pending

**UEPFSQU**

RLS quiesce close.

**UEPFILE**

Address of the 8-byte file name.

**UEPFINFO**

Address of a storage area containing information about the file. The area can be mapped using the DSECT DFHUEFDS, which contains the following fields:

**UEFLNAME**

The 8-character file name.

**UEDSNAME**

The 44-character dsname of the data set associated with the file, if this has been set before the file request was issued.

**UEFSERV**

One byte indicating the SERVREQ settings for this file. The possible values are:

**UEFRDIM**

Read valid

**UEFUPDIM**

Update valid

**UEFADDIM**

Add valid

**UEFDELIM**

Delete valid

**UEFBRZIM**

Browse valid.

**UEFDSJL**

One byte indicating the automatic journaling options set for this file. The possible values are:

**UEFJRO**

Journal read-only

**UEFJRU**  
Journal read for update

**UEFJWU**  
Journal write update

**UEFJWA**  
Journal write add

**UEFJDSN**  
Dsname has been journaled

**UEFJSYN**  
Journal read synchronously

**UEFJASY**  
Journal write asynchronously.

**UEFDSVJL**  
One byte indicating a further automatic journaling option which applies to VSAM files only. The value is:

**UEFJWAC**  
Write add complete.

**UEFDSJID**  
One byte containing the number of the journal to be used for automatic journaling, if any.

**UEFDSACC**  
One byte indicating the access method of the file. The possible values are:

**UEFVSAM**  
VSAM file

**UEFBDAM**  
BDAM file

**UEFDTBL**  
Data table file

**UEFDTUM**  
User data table file

**UEFCFDT**  
Coupling facility data table

**UEFBCRV**  
Set to nulls for this exit.

**UEFFRLOG**  
Set to nulls for this exit.

**UEFFRCLG**  
Set to blanks for this exit.

**UEFCDATE**  
Set to nulls for this exit.

**UEFCTIME**  
Set to nulls for this exit.

**UEFBCAS**  
Set to nulls for this exit.



## UEFACBCP

This field is set to nulls in this exit.

**Note:** Only the first seven fields of UEPFINFO are set for this exit. Of the remaining fields, URFFRCLG is set to blanks, and the others are set to nulls.

## UEPRECUR

Address of a halfword recursion counter. The counter is set to 0 when the exit is first invoked, and is incremented for each recursive call.

## Return codes

### UERCNORM

Continue processing.

### UERCBYP

Suppress the file request. You cannot use UERCBYP:

- To suppress a CLOSE request if the second byte of UEPFREQ indicates it is one of the following types of close:
  - End of load-mode close (UEPFSELM)
  - Immediate close (UEPFSIMM)
  - Immediate close pending (UEPFSICP)
- To suppress an OPEN request if a file is being opened to carry out backout processing, because this would cause a backout failure. The second byte of UEPFREQ is set to UEPFQSOFB if the file is being opened for backout.

In the case of a valid suppression, CICS issues message DFHFC0996:

```
Open/Close/Enable/Disable/Cancel of close of file
filename suppressed due to intervention of user exit
```

### UERCPURG

Task purged during XPI call.

## XPI calls

All can be used.

## API and SPI calls

All except EXEC CICS SHUTDOWN and EXEC CICS XCTL can be used.

## Note:

1. Take care when issuing recursive commands not to cause a loop. For example, it is your responsibility to avoid entering a loop when a file control request is issued from the XFCSREQ exit. Use of the recursion counter UEPRECUR is recommended.
2. Exit programs that issue EXEC CICS commands must first address the EIB. See "Using CICS services" on page 4.
3. Exit programs that issue EXEC CICS commands, and that use the DFHEIENT macro, should use the DFHEIRET macro to set a return code and return to CICS. See "Returning values to CICS" on page 10.
4. Exit programs can invoke EXEC CICS SET commands against the file whose state change has led to the exit being invoked. However, dependent upon other concurrent activity within the CICS system, there is the potential for a deadlock to occur between tasks that are manipulating the state of the file by means of such SPI commands.

## Exit XFCSREQC

### When invoked

After a file ENABLE, DISABLE, OPEN, CLOSE, or CANCEL CLOSE command has completed.

**Note:** The exit is not invoked for function-shipped requests.

### Exit-specific parameters

#### UEPFSREQ

Address of a 2-byte field that indicates the type of file request. The first byte contains one of the following values:

#### UEPFSOPN

Open request

#### UEPFSCLS

Close request

#### UEPFSENB

Enable request

#### UEPFSDIS

Disable request

#### UEPFSKAN

Cancel file close request.

If the first byte indicates an open request (UEPFSOPN), the second byte shows the type of open:

#### UEPFSNOP

Normal open

#### UEPFSOFB

Open for backout.

If the first byte indicates a close request (UEPFSCLS), the second byte shows the type of close:

#### UEPFSNC

Normal close

#### UEPFSCP

Close pending

#### UEPFSELM

End of load mode close

#### UEPFSIMM

Immediate close

#### UEPFSICP

Immediate close pending

#### UEPFSQU

RLS quiesce close.

#### UEPFILE

Address of the 8-byte file name.

#### UEPFINFO

Address of a storage area containing information about the file. The area can be mapped using the DSECT DFHUEFDS, which contains the following fields:

**UEFLNAME**

The 8-character file name.

**UEDSNAME**

The 44-character dsname of the data set associated with the file.

**UEFSERV**

One byte indicating the SERVREQ settings for this file. The possible values are:

**UEFRDIM**

Read valid

**UEFUPDIM**

Update valid

**UEFADDIM**

Add valid

**UEFDELIM**

Delete valid

**UEFBRZIM**

Browse valid.

**UEFDSJL**

One byte indicating the automatic journaling options set for this file. The possible values are:

**UEFJRO**

Journal read-only

**UEFJRU**

Journal read for update

**UEFJWU**

Journal write update

**UEFJWA**

Journal write add

**UEFJDSN**

Dsname has been journaled

**UEFJSYN**

Journal read synchronously

**UEFJASY**

Journal write asynchronously.

**UEFDSVJL**

One byte indicating a further automatic journaling option which applies to VSAM files only. The value is:

**UEFJWAC**

Write add complete.

**UEFDSJID**

One byte containing the number of the journal to be used for automatic journaling, if any.

**UEFDSACC**

One byte indicating the access method of the file. The possible values are:

**UEFVSAM**  
VSAM file

**UEFBDAM**  
BDAM file

**UEFDTBL**  
Data table file

**UEFDTUM**  
User data table file

**UEFCFDT**  
Coupling facility data table

**UEFBCRV**

One byte indicating the recovery attributes of the data set associated with this file. The possible values are:

**UEFBCFR**  
Forward recovery specified

**UEFBCLOG**  
Logging specified

**UEFBCVAL**  
Flag indicating that recovery attributes are valid.

**UEFFRLOG**

A 1-byte field containing the forward recovery log identifier in the range 1—99, taken from the recovery attributes in the CICS file resource definition. This number corresponds to a CICS internal journal name of the form DFHJnn, where nn is the forward recovery log number. CICS maps this journal name to a forward recovery log stream.

The field is set to zero if forward recovery logging is not specified for the file, or if the forward recovery log stream name has been obtained from the ICF catalog.

**UEFFRCLG**

A 26-byte field containing the name of the forward recovery log stream taken from the ICF catalog, to be used for forward recovery. Set to blanks if not specified in the ICF catalog or if forward recovery is not being used for the file.

**UEFCDATE**

A date (YYYYDDD+) in packed decimal format. This field is set only when the file is the last file to close against the VSAM sphere with which it is associated. It contains the date when activity against the VSAM sphere was brought to an end (quiesced).

**UEFCTIME**

A time (HHMMSST+) in packed decimal format. This field is set only when the file is the last file to close against the VSAM sphere with which it is associated. It contains the time when activity against the VSAM sphere was brought to an end.

**UEFBCAS**

A flag-byte indicating the availability of this data set. If set, the value is:

## **UEPFBCAS**

Data set marked unavailable.

## **UEFACBCP**

Address of a read-only copy of the ACB for a VSAM file, or the DCB for a BDAM file. Set only after completion of a successful open. If UEFDTBL and UEFDTUM have been set on, then the storage addressed by UEFACBCP is undefined. This pointer should not be used.

## **UEPFSRSP**

Address of a byte containing the return codes for the request. This has one of the following values:

### **UEFSNORM**

Normal response.

### **UEFSWARN**

Warning response.

### **UEFSFAIL**

Failure response.

### **UEFSPEND**

Pending response. The 'Pending' response can be returned only after a CLOSE request. It indicates that, as a result of the CLOSE request, a closure is pending on the file, the file is being quiesced. When all activity against the file has completed, it is closed. Note that, if enabled, the XFCSREQ and XFCSREQC exits are driven again, when the actual closure takes place.

## **UEPRECUR**

Address of a halfword recursion counter. The counter is set to 0 when the exit is first invoked, and is incremented for each recursive call.

### **Note:**

1. The first seven fields of UEPFINFO (UEFLNAME through UEFDSACC) are set for all requests; that is, following an OPEN, CLOSE, ENABLE, or DISABLE request.
2. The next three fields (UEFBCRV, UEFFRLOG, and UEFFRCLG) are valid only after a successful OPEN request.
3. The fields UEFCDATE through UEFCBCAS are set only after a successful CLOSE request. After all other requests, if the file is already closed, if the closure fails, or if the closure is pending, these fields are set to nulls.
4. Exit programs can invoke EXEC CICS SET commands against the file whose state change has led to the exit being invoked. However, dependent upon other concurrent activity within the CICS system, there is the potential for a deadlock to occur between tasks that are manipulating the state of the file by means of such SPI commands.

## **Return codes**

### **UERCNORM**

Continue processing.

## UERCPURG

Task purged during XPI call.

### XPI calls

All can be used.

### API and SPI calls

All except EXEC CICS SHUTDOWN and EXEC CICS XCTL can be used.

### Note:

1. Take care when issuing recursive commands not to cause a loop. For example, it is your responsibility to avoid entering a loop when a file control request is issued from the XFCSREQC exit. Use of the recursion counter UEPRECUR is recommended.
2. Exit programs that issue EXEC CICS commands must first address the EIB. See "Using CICS services" on page 4.
3. Exit programs that issue EXEC CICS commands, and that use the DFHEIENT macro, should use the DFHEIRET macro to set a return code and return to CICS. See "Returning values to CICS" on page 10.

**The DFH\$REQC sample global user exit program:** DFH\$REQC provides sample processing for the file control state program global user exit, XFCSREQC. The exit program, if enabled at the XFCSREQC exit point, is invoked after a file ENABLE, DISABLE, OPEN, CLOSE, or CANCEL CLOSE request has been acted on.

There is more information about using the sample program in the comments in the DFH\$REQC source code. In summary, DFH\$REQC performs the following processing :

1. Checks whether an open request for a VSAM data set has been acted on and that the ACB error flag (ACBERFLG) is non zero.
2. If all are true, performs default processing. The ACBERFLG error code is checked. If it is equal to X'74', the following message and data areas are built into 690 bytes of contiguous storage, in such a way that they conform to the editing rules of the WRITE OPERATOR command:

#### Message

VSAM Open error has occurred – VSAM error flag X'nn'

The ACBERFLG error code is converted from hex to character format and appended to the end of the message.

#### Access method control block (ACB)

The data starts with an 'ACB' eye-catcher. All the data within the ACB is converted into character format and added after the eye-catcher.

#### Exec Interface Block (EIB)

The data starts with an 'EIB' eye-catcher. All the data within the EIB is converted into character format and added after the eye-catcher.

#### Parameter list passed to the exit program

The data starts with a 'PLIST' eye-catcher. Only the exit-specific parameters are converted to character format and added after the eye-catcher.

#### File Information

The data starts with a 'FINFO' eye-catcher. This is followed by the 8-character file name and the 44-character dsname of the data set

associated with the file, as described by fields UEFLNAME and UEDSNAME in the DFHUEFDS DSECT.

3. Issues a WRITE OPERATOR command to write as much data as has been created in the 690 bytes of storage to the system console.
4. Returns a normal response of zero in register 15.

The sample program contains logic to write the same messages and data areas that are written on the default processing path to a transient data queue. In this case, output is edited into lines of 132 bytes. Each line is written when it is full, at which point (or upon request) a new data area or message is started.

In addition, the program logic allows for other VSAM error codes to be tested. These can be actioned to follow existing paths within the program, or tailored to use all or part of the set of messages and data areas already defined. Alternatively, the sample program can be customized to expand the set of messages and data areas written.

#### **Related concepts**

“The file control state program sample exit program” on page 19

## **File control open/close program exit XFCNREC**

You can use XFCNREC to suppress the open failure that occurs when either of the following occurs:

- A mismatch is detected between the backout recovery setting for a file and its associated (non-RLS) data set.
- A mismatch is detected because BWO(TYPECICS) and LOG(NONE) are both specified on the same non-RLS dataset.

**Note:** This exit is not invoked for RLS opens. For RLS, recovery is a property of the data set. Therefore it is not possible for files and their base data set to have unmatched recovery attributes.

For more information about writing an XFCNREC exit program, see the *CICS Recovery and Restart Guide*.

### **Using XFCNREC with a back out recovery setting mismatch**

XFCNREC is intended for those who want to continue with open processing even though the backout recovery settings for different files associated with the same base data set are not consistent.

After an open failure has been suppressed, CICS can no longer guarantee integrity for the data set and marks it accordingly. Any subsequent EXEC CICS INQUIRE DSNAME OR CEMT INQUIRE DSNAME RECOVSTATUS command returns NOTRECOVABLE. Logging continues for the data set for requests via any file that has BACKOUT on its definitions, but not for those that do not have BACKOUT.

The mismatched state of the data set continues until an EXEC CICS or CEMT SET DSNAME REMOVE command is issued, or until an initial or cold start of CICS. (if the associated data set is not in backout failed state).

At the point at which the mismatch is accepted, CICS issues a message to warn that integrity can no longer be guaranteed.

The order in which files are opened for the same base data set will determine the content of the message received on suppression of an open failure using

XFCNREC. If the base cluster block is set as unrecoverable and a mismatch has been allowed, access may be allowed to the data set, via an unrecoverable file, before the data set is fully recovered.

To provide a means of selecting which mismatches to accept and which to reject, three parameters are passed to the exit. These are the address of the filename, the address of the base data set name, and the address of a byte containing the file backout indicator. Because the exit is driven only if there is a mismatch, the data set backout indicator can be derived from the setting for the file.

**Note:** If XFCNREC is used to suppress an open failure due to a mismatch, the global user exit XFCSREQC will pass the base data set backout setting as the exit parameter UEFBCRV, and not the file backout setting, which may be different.

### Using XFCNREC with a BWO mismatch

Exit XFCNREC can allow the file to be opened and CICS will continue to run normally. However, forward recovery will not be available for the opened dataset.

## File control quiesce receive exit, XFCVSDS

The XFCVSDS exit is invoked when VSAM RLS notifies CICS that processing is required as a result of some data set-related events occurring in the sysplex. XFCVSDS is invoked *before* CICS processing takes place, and only if a data set name block (DSNB) exists for the data set. The actions that cause XFCVSDS to be invoked are:

- **A data set is being quiesced throughout the sysplex.**

CICS is informed about this action only if it has files open in RLS mode against the data set.

If CICS is notified about a quiesce action, the XFCVSDS global user exit program can cancel the data set quiesce, in which case it cancels the quiesce throughout the sysplex, and the data set remains in the unquiesced state.
- **A data set is being unquiesced throughout the sysplex.**

All CICS regions in the sysplex that are registered with a VSAM RLS control ACB are informed about unquiesce actions.
- **DFSMSdss wants to start a non-BWO backup of a data set.**

CICS is notified about a non-BWO backup start action only if it has files open in RLS mode against the data set.

If CICS is notified about a non-BWO backup start action, XFCVSDS can be used to cancel the backup.
- **DFSMS has completed a non-BWO backup of a data set.**

All CICS regions in the sysplex that are registered with a VSAM RLS control ACB are informed about non-BWO backup complete actions.
- **DFSMS wants to start a BWO backup of a data set.**

CICS is notified about a BWO backup start action only if it has files open in RLS mode against the data set.

If CICS is notified about a BWO backup start action, XFCVSDS can be used to cancel the backup.
- **DFSMS has completed a BWO backup of a data set.**

All CICS regions in the sysplex that are registered with a VSAM RLS control ACB are informed about BWO backup complete actions.



## Exit XFCVSDS

### When invoked

Invoked after VSAM RLS has informed CICS that processing is required as a result of a data set-related action occurring in the sysplex.

### Exit-specific parameters

#### UEPDSNAM

Address of a 44-byte field containing the name of the data set to which the action applies

#### UEPVSACT

Address of a 1-byte field indicating the RLS action of which CICS has been informed. Possible values are:

#### UEQUIES

Quiesce

#### UEUNQUIS

Unquiesce

#### UENBWST

Non-BWO backup start

#### UENBWCMP

Non-BWO backup complete

#### UEBWOST

BWO backup start

#### UEBWOCMP

BWO backup complete.

#### UEPQUCLS

Address of a 1-byte field indicating, for UEQUIES only, how files open in RLS mode are to be closed. Possible values are:

#### UEORDCLO

Wait until all in-flight UOWs that are accessing the data set have completed syncpoint before closing.

#### UEIMMCLO

Abend all in-flight UOWs that are accessing the data set before closing.

#### UEPCPTEC

Address of a 1-byte field indicating, for UENBWST and UEBWOST only, whether the backup is to use the concurrent copy technique. Possible values are:

#### UEORDCOP

Concurrent copy is not being used.

#### UECONCOP

Concurrent copy is being used.

### Return codes

#### UERCNORM

Continue processing—complete the actions required to support the VSAM RLS operation.

#### UERCBYP

This applies only to actions UEQUIES, UENBWST and UEBWOST.

CICS is *not* to carry out the processing required for the VSAM RLS action, and is to cancel the action throughout the sysplex.

A return code of UERCPURG is not allowed.

#### **XPI calls**

All can be used.

#### **API and SPI calls**

You can use CICS API and SPI commands at this exit. In general all can be used, with the following restrictions:

- You should avoid the use of commands that cause the issuing task to suspend.
- You must not use EXEC CICS SHUTDOWN or EXEC CICS XCTL.
- You must not use the QUIESCESTATE option of EXEC CICS SET DSNAME for data set UEPDSNAM.
- You must not use the OPENSTATUS option of EXEC CICS SET FILE, or issue file control requests, for files that reference data set UEPDSNAM.

## **File control quiesce send exit XFCQUIS**

The XFCQUIS global user exit is invoked on completion of a VSAM RLS quiesce or unquiesce of a data set that was requested either by a CEMT or EXEC CICS SET DSNAME QUIESCESTATE command.

The exit is invoked regardless of whether the QUIESCESTATE action has completed successfully or unsuccessfully. This enables you to perform, or schedule, any processing that cannot take place until quiesce or unquiesce processing has finished.

#### **When invoked**

On completion, successful or failed, of a SET DSNAME QUIESCESTATE command.

#### **Exit-specific parameters**

##### **UEPQDSNM**

Address of a 44-byte field containing the name of the data set that was being quiesced or unquiesced.

##### **UEPQSTAT**

Address of a 1-byte field indicating whether the data set was being quiesced or unquiesced. Possible values are:

##### **UEQSD**

Data set was being quiesced by QUIESCESTATE(QUIESCED). In-flight UOWs accessing the data set completed syncpoint before files open in RLS mode were closed.

##### **UEIMQSD**

Data set was being quiesced by QUIESCESTATE(IMMQUIESCED). In-flight UOWs accessing the data set were abended before files open in RLS mode were closed.

##### **UEUNQSD**

Data set was being unquiesced by QUIESCESTATE(UNQUIESCED).

**UEPQRCDE**

Address of a 1-byte field indicating the result of the quiesce or unquiesce. Possible values are:

**UEQOK**

Successful.

**UEQREJEC**

Rejected—see UEPQCONF for the reason code.

**UEQUNKNO**

Failed because data set not known to DFSMS as a VSAM data set.

**UEQIOERR**

Failed because of RLS error or SMSVSAM server not available.

**UEQCANCL**

Failed because quiesce was canceled by user (UEQSD and UEIMQSD only).

**UEQTIMED**

Failed because quiesce was canceled due to timeout (UEQSD and UEIMQSD only).

**UEQMIGRT**

Failed because the data set has been migrated.

**UEPQCONF**

Address of a 1-byte field indicating the reason why the quiesce or unquiesce was rejected (for UEQREJEC only). Possible values are:

**UEQUIINP**

Quiesce is in progress (UEQSD and UEIMQSD status only).

**UEUNQINP**

Unquiesce is in progress.

**UENBWINP**

Non-BWO copy is in progress.

**UEBWOINP**

BWO copy is in progress.

**UEUNKINP**

Unknown event is in progress.

**Return codes****UERCNORM**

Continue processing.

A return code of UERCPURG is not allowed.

**XPI calls**

All can be used.

**API and SPI calls**

You can use CICS API and SPI commands at this exit. In general, all except EXEC CICS SHUTDOWN and EXEC CICS XCTL can be used, but you must not use the QUIESCESTATE keyword of EXEC CICS SET DSNAME.

## File control recovery program exits XFCBFAIL, XFCBOUT, XFCBOVER, and XFCLDEL

CICS provides four global user exits that you can use in connection with file control recovery operations. These are:

### XFCBFAIL

Invoked when an error occurs during backout.

### XFCBOUT

Invoked when CICS is about to back out a file update.

### XFCBOVER

Invoked when CICS is about to skip unit-of-work (UOW) backout because a batch program has overridden RLS retained lock protection and opened a data set for batch processing.

### XFCLDEL

Invoked when backing out a write to a BDAM or a VSAM ESDS data set.

### Order of invocation

Each of the exits in the file control recovery program may or may not be invoked during an attempt to backout a file update. If the backout fails, each may (or may not) be reinvoked when the backout is retried. If an exit program needs to know whether it is being invoked during the original backout attempt, or during a retry, it can check the value of the RE\_ATTACHED\_TRANSACTION field returned by an XPI INQUIRE\_TRANSACTION call.

The way in which the exits interact, and the order in which they are invoked, is shown in the following list. Assuming that all the exits are enabled, for each backout attempt or retried backout attempt:

1. If an open during backout fails, XFCBFAIL is invoked. **None of the other exits is invoked.**
2. If the SHCDS PERMITNONRLSUPDATE command has been issued for the data set being backed out, XFCBOVER is invoked. **If it returns UERCNORM (do not perform the backout), no further exits are invoked.**
3. Unless item 1 applies, or XFCBOVER has been invoked and returned UERCNORM, XFCBOUT is invoked.
4. Backout issues a read update request for the record being backed out. If the read update fails, XFCBFAIL is invoked, followed by **no further exits.**
5. If the update to be backed out was a write to a data set which does not support physical deletes (that is, a BDAM data set or a VSAM ESDS), XFCLDEL is invoked.
6. If a failure occurs after this point, XFCBFAIL is invoked.

### Enabling the exit programs

To enable these exits, you must do one of the following:

- Specify the system initialization parameter  
TBEXITS=(name1,name2,name3,name4,name5,name6), where name1 through name6 are the names of your user exit programs for XRCINIT, XRCINPT, XFCBFAIL, XFCLDEL, XFCBOVER, and XFCBOUT.
- Enable the exits during the first stage of initialization using a PLTPI program.

If you use the TBEXITS parameter to enable the exits, a global work area of 4 bytes is provided. If you use a PLTPI program, you can select the size of the global work area. You can also enable more than one exit program for use at each exit

point; the TBEXITS parameter allows only one exit program at each exit point. PLTPI processing is described in Chapter 4, “Writing initialization and shutdown programs,” on page 425.

### **Exit XFCBFAIL, file control backout failure exit**

XFCBFAIL is invoked whenever there is a failure during backout of an update made to a file record.

If, within a given UOW, there are backout failures for more than one record in the same file, or for records in multiple files, the exit is invoked:

- For the first record in each data set for which backout fails.  
If more than one file is associated with a single data set, only the first record in the first of the files to fail backout within the UOW causes CICS to invoke the exit. All subsequent records are failed with the same error, but the exit is not invoked again.
- For the first record for each data set that fails during any retry of the backout for this UOW.

It is not invoked for backout failures to other (non-file-control) resources within the UOW.

For VSAM data sets, backout failure processing saves information that allows the backout to be retried later.

For BDAM data sets, the backout cannot be retried. If backout fails against a BDAM data set, you can use the XFCBFAIL exit to preserve data integrity by terminating CICS immediately. If the XFCBFAIL exit is not enabled, or does not terminate CICS, the BDAM data is committed and the locks are released. If the exit is enabled, you can use the XFCBFAIL global user exit program to save information that you can use to manually correct the data. However, you need to be careful that in doing this you do not back out other changes made between the time of the backout failure and the time of your own manual recovery action.

#### **When invoked**

If an error occurs during backout of a change made to a file (on the first failure in the UOW for the data set associated with the file).

#### **Exit-specific parameters**

##### **UEPBLOGR**

Address of the file control portion of the log record that represents the update that was being backed out when the file control failure occurred. The log record can be mapped using the DSECT DFHFCLGD.

##### **UEPTRANS**

Address of a 4-byte field containing the transaction id under which the update that is being backed out was made.

##### **UEPTRMNL**

Address of the 4-byte terminal id for the terminal or principal facility from which the update that is being backed out was made.

##### **UEPTASK**

Address of the 4-byte (packed decimal) field containing the task number for the task under which the update that is being backed out was made.

**UEPFCRSP**

Address of the file control response byte. This can have one of the following values:

**UEAIXFUL**

No space in non-unique alternate index.

**UECACHE**

RLS cache failure or cache connectivity failure.

**UENBWBK**

Non-BWO backup in progress.

**UEDLOCK**

Deadlock detected.

**UEDUPREC**

Duplicate key on unique alternate index.

**UEIOEROR**

I/O error.

**UELCKFUL**

RLS lock structure full.

**UENOLDEL**

Logical delete not carried out (XFCLDEL exit point is either not enabled or the XFCLDEL global user exit program chose not to perform the logical delete).

**UENOSPAC**

Data set out of storage.

**UEOPENER**

Error opening the file.

**UERLSERR**

SMSVSAM RLS server failure.

**UERLSDIS**

RLS access is currently disabled.

**UERLSCON**

Attempt to continue a thread with a new instance of the SMSVSAM RLS server.

**UEUNEXP**

Unexpected error.

**UEPERR**

Address of a one-byte field containing the error type. The values of the error-byte and their meanings are described in "Values of the error-type byte referenced by UEPERR" on page 129.

**Return codes****UERCNORM**

Continue processing and invoke CICS backout failure control.

This causes a backout failure error message to be issued (DFHFC4701 for a VSAM data set, and DFHFC4702 for a BDAM data set). For a VSAM data set CICS converts the record lock into a retained lock, and the log record is saved for a later retry of the backout.

## **UERCBYB**

Ignore the error (do not invoke CICS backout failure control) and continue. Setting this return code could be damaging to the integrity of your data.

A return code of UERCPURG is not allowed. There is no need to set a UERCPURG return code, because the conditions under which this exit is invoked mean that a purged condition cannot be returned by any XPI or API calls.

### **XPI calls**

All can be used, but subject to the same caution as for API and SPI calls.

### **API and SPI calls**

Although this exit is allowed to issue API and SPI calls, you should be very careful about which commands you use because the exit is invoked during file backout, which is part of syncpoint phase 2.

It is recommended that you restrict EXEC CICS commands to inquiries, and avoid commands that update CICS resources, because the resources may themselves be in a state of recovery. In particular, the following restrictions apply:

1. Do not issue any recoverable operations.
2. Do not use operations that access systems or resource owners external to this CICS, even if the target resource is non-recoverable.
3. Do not disable or close files, because this could cause further error conditions.
4. It is possible for this exit to be invoked under a different transaction environment from that under which the updates that are being backed out were originally made. If your exit program wants to perform any actions (such as writing a message to the terminal) that require it to be running under the original transaction environment, it must first check the value returned in the RE\_ATTACHED\_TRANSACTION parameter of a transaction manager INQUIRE\_TRANSACTION XPI call.

### ***Values of the error-type byte referenced by UEPERR:***

The UEPERR field in the XFCBFAIL parameter list points to an error-type byte, which contains one of the following values:

#### **XBFERU**

An error response has been returned from the file control file-request-handler program while processing a READ UPDATE request. This request is issued by file control backout to retrieve the existing copy of the record before backing it out.

Use UEPFCRSP in combination with the type of record, shown in the file control portion of the log record addressed by parameter UEPBLOGR, to determine the specific problem. The storage area addressed by UEPBLOGR contains either the before-image of a “read-update” record or the new copy of a “write-add” to be deleted. The type-of-record field, FLJB\_RECORD\_TYPE, is defined in DSECT DFHFCLGD.

#### **XBFERE**

An error response has been returned from the file control file-request-handler program while processing a REWRITE request. This request is issued by file control backout to replace the existing copy of the

record on the data set with the “before-image” held in the log record addressed by UEPBLOGR. Use parameter UEPFCRSP to determine which error occurred.

#### **XBFEWR**

An error response has been returned from the file control file-request-handler program while processing a WRITE request. This request is issued by file control backout to add the “before-image” of a deleted record. Use parameter UEPFCRSP to determine which error occurred.

#### **XBFEDL**

An error response has been returned from the file control file-request-handler program while processing a REWRITE DELETE request. This request is issued by file control backout to delete a new record added to a VSAM data set. Use parameter UEPFCRSP to determine which error occurred.

#### **XBFENO**

The failure that occurred during file control backout was not as a result of an error response from the file control file-request-handler program. Use parameter UEPFCRSP to determine which error occurred.

***DFH\$FCBF sample global user exit program:*** DFH\$FCBF provides sample processing for the file control backout failure global user exit, XFCBFAIL. The exit program, if enabled at the XFCBFAIL exit point, is invoked if an error occurs during backout of a file control update.

There is more information about using the XFCBFAIL user exit, and the sample program, in the comments within the DFH\$FCBF source code. The comments also include some suggested extensions to the sample program.

In summary, DFH\$FCBF performs the following processing:

- If tracing is active for file control, makes a user trace entry. This has trace point id X'01D0' and traces:
  - An eye-catcher 'DFH\$FCBF ENTRY'
  - The file control response byte
  - The error type
  - The file control portion of the log record.
- Issues an EXEC CICS INQUIRE FILE command to check the access method to see if the data set is BDAM. If it is, CICS does not support backout retries. Therefore, a message is written to the console advising that either this file and any other files using the base data set (named in message DFHFC4702) should be closed, or CICS should be shut down to prevent further corruption. Sets a response of UERCNORM and takes the normal exit from the program.
- If the access method is neither BDAM nor VSAM, takes the error exit from the program.
- Checks whether the file is one for which it has been decided that backout failures will be ignored, by checking the filename (field FLJB\_FILE\_NAME in the log record). The sample program writes a message to the console to this effect, then sets a response of UERCBYP and takes the normal exit from the program. A return code of UERCBYP specifies that the error should be ignored. This causes CICS not to retry the backout; the result is as if the data were committed instead of being backed out.



The sample program takes this step to demonstrate the use of the UERCBYP return code. It is not recommended that you use UERCBYP with important data sets.

- Examines the file control response code and issues a message to the console describing the procedure to be followed for this error. The sample program provides slots for each possible file control response code, and includes suggested messages for some of them. The sample program should be customized by expanding the set of messages to describe procedures that are appropriate for your installation for each error, or to take other action within the exit program. If you do not add a message for any particular response code, the operator still sees message DFHFC4701, which advises on any action that needs to be taken. This is issued as part of CICS backout failure processing.
- Sets a response code of UERCNORM and takes the normal exit from the program. A return code of UERCNORM specifies that CICS backout failure processing is to be carried out. This means that CICS issues a backout failure error message and, for a VSAM data set, ensures that the record remains locked until the backout can be retried and saves the log record for later retry.
- Normal exit from the program writes a user trace entry if tracing is active for file control and there were no errors during processing. This has trace point id X'01D1' and traces:
  - An eye-catcher 'DFH\$FCBF EXIT OK'
  - The file control portion of the log record
  - Some text: 'Handle backout failure' or 'Bypass backout failure' as appropriate.
- Error exit from the program (taken if errors occur during processing or if CICS functions fail):
  - Writes a user exception trace entry regardless of the trace setting. This has trace point id X'01D2' and traces:
    - An eye-catcher 'USEREXC'
    - An eye-catcher 'DFH\$FCBF EXIT FAIL'
    - The file control portion of the log record.
  - Returns a response of UERCNORM so that, although an error has occurred in the exit, CICS still performs its normal backout failure processing.

### **Related concepts**

"The file control recovery program sample exit programs" on page 19

### **Exit XFCBOUT, file control backout exit**

XFCBOUT is invoked when a file control update is about to be backed out. The log record containing the before-image of the record being backed out is passed to the exit program.

XFCBOUT does not provide a return code to allow your exit program to bypass the backout of the update, because this would result in data corruption.

**Migration note:** XFCBOUT replaces the function provided for file control, in releases before CICS Transaction Server for OS/390, Version 1 Release 1, by the XDBIN and XRCINPT exits. In earlier releases:

- XDBIN was invoked when a dynamic log record was processed during dynamic backout. It was passed the log record being processed.
- XRCINPT was invoked when a log record from the restart data set was processed during backout of in-flight work at emergency restart. It was passed the log record, and the address of the FBO table entry.

Because the same backout code is executed following an emergency restart as at any other time, XFCBOUT replaces both XRCINPT and XDBIN for file data. The address of an FBO entry is not supplied (there is no FBO table in CICS Transaction Server for z/OS, Version 3 Release 2). However, the file name is in the log record, so your exit program can use an EXEC CICS INQUIRE FILE command to get information about the file.

#### **When invoked**

Invoked when an update (represented by a before-image log record) is being backed out by File Control.

#### **Exit-specific parameters**

##### **UEPFLOGR**

The address of the file control portion of the log record that is being presented for backout. This is mapped by the DSECT DFHFCLGD.

#### **Return codes**

##### **UERCNORM**

Continue processing.

A return code of UERCPURG is not allowed. There is no need to set a UERCPURG return code, because this exit is invoked during syncpoint phase 2, and therefore cannot get a purged response from any calls it makes.

#### **XPI calls**

All can be used, but subject to the same caution as for API and SPI calls.

#### **API and SPI calls**

Although this exit is allowed to issue API and SPI calls, you should be very careful about which commands you use because the exit is invoked during file backout, which is part of syncpoint phase 2.

It is recommended that you restrict EXEC CICS commands to inquiries, and avoid commands that update CICS resources, because the resources may themselves be in a state of recovery. In particular, the following restrictions apply:

1. Do not issue any recoverable operations.
2. Do not use operations that access systems or resource owners external to this CICS, even if the target resource is non-recoverable.
3. Do not disable or close files, because this could cause further error conditions.
4. It is possible for this exit to be invoked under a different transaction environment from that under which the updates that are being backed out were originally made. If your exit program wants to perform any actions (such as writing a message to the terminal) that require it to be running under the original transaction environment, it must first check the value returned in the RE\_ATTACHED\_TRANSACTION parameter of a transaction manager INQUIRE\_TRANSACTION XPI call.

Because it is anticipated that XFCBOUT will be used for specific applications, no general-purpose sample exit program is provided. You could use any of samples for the other file control recovery exits—DFH\$FCBF, DFH\$FCBV, or DFH\$FCLD—as the basis for an XFCBOUT exit program.

#### **Exit XFCBOVER, file control backout override exit**

XFCBOVER is part of the support CICS file control provides for “batch windows” in a VSAM RLS environment.

VSAM RLS locks individual records within a data set, and these locks are converted to retained locks for those UOWs that are not completed because of backout or in-doubt failures, thus preserving data integrity. To avoid corruption of a data set by a non-RLS batch job, which is not aware of the retained record locks, a data set cannot normally be opened for update in non-RLS mode if it has any locked records.

**Retained lock override for batch:** There may be circumstances in which you want to override these locks and force the open of a data set for batch processing. For example, when:

- There is insufficient time available, before running the batch job, in which to resolve the situation that caused the records to be locked, or
- It is known that the batch job cannot harm data integrity (because it does not update existing records in the data set, or it does not update any records that CICS may have updated).

To override the open restriction, VSAM RLS provides the SHCDS PERMITNONRLSUPDATE command, to allow a non-RLS batch job to open a sphere for update even when there are retained locks.

**Effect of retained lock override on CICS:** VSAM records the use of the option to override retained locks, so that it can notify a CICS region when the region next opens the data set. Because data could have been altered by the non-RLS batch job, the results of CICS performing any recovery (on UOWs that were in a backout-failed or indoubt-failed state at the time of the batch job) are unpredictable. In this situation, therefore, the default CICS action is not to back out any updates that were outstanding at the time that locks were overridden, and to write diagnostic information about each backout ignored to the CSFL transient data queue.

The XFCBOVER global user exit is provided to enable you, for each UOW log record for which backout is being ignored, to:

- Write application-related diagnostics to supplement those provided by CICS
- To perform application-related recovery actions
- To reverse the default by requesting that the backout should be carried out after all. This option is required for the case where the batch job is known not to corrupt data integrity (for example, because it only inserts records).

#### **When invoked**

Whenever CICS is about to ignore a UOW log record that is due to be backed out, because the lock that protected the updated record could have been overridden by a non-RLS batch program.

#### **Exit-specific parameters**

##### **UEPOLOGR**

Address of the file control portion of a shunted log record that represents an update to a data set for which retained locks may have been overridden. The file control portion of the log record can be mapped using the DSECT DFHFCLGD.

##### **UEPODSN**

Address of a 44-byte area of storage containing the name of the data set whose locks were overridden.

#### **Return codes**

## **UERCNORM**

Do not perform the backout of this log record. Any updates performed by the batch run should take precedence.

## **UERCBCKO**

Perform the backout. It is known that the actions of the batch job could not have affected this update.

A return code of UERCPURG is not allowed. There is no need to set a UERCPURG return code, because this global user exit is invoked during syncpoint phase 2, and therefore cannot get a purged response from any calls that it makes.

## **XPI calls**

All can be used, but subject to the same caution as for API and SPI calls.

## **API and SPI calls**

Although this exit is allowed to issue API and SPI calls, you should be very careful about which commands you use because the exit is invoked during file backout, which is part of syncpoint phase 2.

It is recommended that you restrict EXEC CICS commands to inquiries, and avoid commands that update CICS resources, because the resources may themselves be in a state of recovery. In particular, the following restrictions apply:

1. Do not issue any recoverable operations.
2. Do not use operations that access systems or resource owners external to this CICS, even if the target resource is non-recoverable.
3. Do not disable or close files, because this could cause further error conditions.
4. It is possible for this exit to be invoked under a different transaction environment from that under which the updates that are being backed out were originally made. If your exit program wants to perform any actions (such as writing a message to the terminal) that require it to be running under the original transaction environment, it must first check the value returned in the RE\_ATTACHED\_TRANSACTION parameter of a transaction manager INQUIRE\_TRANSACTION XPI call.

***DFH\$FCBV sample global user exit program:*** DFH\$FCBV provides sample processing for the file control backout override global user exit, XFCBOVER. The exit program, if enabled at the XFCBOVER exit point, is invoked when a log record is presented to file control for backing out an update to a data set in RLS access mode, after the data set has been used in a batch update despite the existence of retained locks. A consequence of running a batch program while there are retained locks is that a lock that protected a record updated by CICS could have been overridden by a non-RLS batch program.

There is more information about using the XFCBOVER exit, and about the DFH\$FCBV sample program, in the comments within the DFH\$FCBV source code. The comments also include some suggested extensions that you can make to the sample program to reflect the pattern of batch usage at your installation.

In summary, DFH\$FCBV performs the following processing:

- Makes a user trace entry if tracing is active for file control. This has trace point id X'01E0' and traces:
  - An eye-catcher 'DFH\$FCBV ENTRY'

- The data set name
- The file control portion of the log record.
- Checks the data set name to see if it is one of those for which it is known that batch programs never update existing records, but only insert new records, or do not make updates at all. The sample program contains a table of such data sets. If this data set is in the table, UERCBCKO is returned. UERCBCKO means that CICS is to perform the backout, despite the override option having been used, because the locked record cannot have been updated by a batch job.
- For all other data sets, it must be assumed that the batch job could have updated the record being backed out. The sample therefore returns UERCNORM, which instructs CICS to take the default action of not backing out the update.
- Exit from the program, making:
  - A user trace entry if tracing is active for file control. This has trace point id X'01E1' and traces:
    - An eye-catcher 'DFH\$FCBV EXIT'
    - The data set name
    - Some text: 'Update will be backed out', or 'Update will not be backed out' as appropriate.

#### **Related concepts**

“The file control recovery program sample exit programs” on page 19

#### **Exit XFCLDEL, file control logical delete exit**

XFCLDEL is invoked whenever a WRITE to a VSAM ESDS, or to a BDAM data set, is being backed out. Because these types of data set do not support deletion, you can use XFCLDEL to perform a logical delete by amending the record in some way that flags it as deleted.

#### **When invoked**

Invoked when backing out a WRITE to a VSAM ESDS or a BDAM data set.

#### **Exit-specific parameters**

##### **UEPBLOGR**

Address of the file control portion of the log record representing the update that is to be backed out by logical deletion. The log record can be mapped using the DSECT DFHFCLGD.

##### **UEPTRANS**

Address of the 4-byte transaction id under which the update that is being backed out was made.

##### **UEPTRMNL**

Address of the 4-byte terminal id for the terminal or principal facility from which the update that is being backed out was made.

##### **UEPTASK**

Address of the 4-byte (packed decimal) task number for the task under which the update that is being backed out was made.

##### **UEPFDATA**

Address of a variable-length field containing the data in the file control request. The exit program can amend the record data addressed by this field, marking it in some way that applications can recognize as representing a logically deleted record.

## **UEPFLEN**

Address of a fullword containing the length of the data in the file control request.

### **Return codes**

#### **UERCFAIL**

Do not perform the logical delete, and treat this as a backout failure. This is the default action taken if the exit is not enabled.

#### **UERCLDEL**

Perform the logical delete by reapplying the updated record.

A return code of UERCPURG is not allowed. There is no need to set a UERCPURG return code, because the conditions under which this exit is invoked should mean that “purged” cannot be returned by any XPI or API calls.

### **XPI calls**

All can be used, but subject to the same caution as for API and SPI calls.

### **API and SPI calls**

Although this exit is allowed to issue API and SPI calls, you should be very careful about which commands you use because the exit is invoked during file backout, which is part of syncpoint phase 2.

It is recommended that you restrict EXEC CICS commands to inquiries, and avoid commands that update CICS resources, because the resources may themselves be in a state of recovery. In particular, the following restrictions apply:

1. Do not issue any recoverable operations.
2. Do not use operations that access systems or resource owners external to this CICS, even if the target resource is non-recoverable.
3. Do not disable or close files, because this could cause further error conditions.
4. It is possible for this exit to be invoked under a different transaction environment from that under which the updates that are being backed out were originally made. If your exit program wants to perform any actions (such as writing a message to the terminal) that require it to be running under the original transaction environment, it must first check the value returned in the RE\_ATTACHED\_TRANSACTION parameter of a transaction manager INQUIRE\_TRANSACTION XPI call.

**DFH\$FCLD sample global user exit program:** DFH\$FCLD provides sample processing for the file control logical delete global user exit, XFCLDEL. The exit program, if enabled at the XFCLDEL exit point, is invoked when a WRITE to a VSAM ESDS or BDAM data set is being backed out. Because these access methods do not support a physical delete operation, special action must be taken to provide a logical delete function. Normally this involves flagging the record in a way that application programs that use the data set recognize as meaning the record has been deleted.

There is more information about using the XFCLDEL user exit, and about the DFH\$FCLD sample program, in the comments within the DFH\$FCLD source code.

In summary, DFH\$FCLD performs the following processing:

- Makes a user trace entry if tracing is active for file control. This has trace point id X'01F0' and traces:

- An eye-catcher 'DFH\$FCLD ENTRY'
- The unmarked file control request data
- The file control portion of the log record.
- Issues an EXEC CICS INQUIRE FILE command to check the access method and type to confirm that the file is a VSAM ESDS or BDAM data set. The logical delete exit should have been invoked only if the file is one of these types.
- For a VSAM ESDS:
  - Flags the record (whose address is passed to the exit in UEPFDATA) as logically deleted. The sample adopts what is probably the most common convention, which is to flag the first byte with a logical delete mark of X'FF'.
  - Takes the normal exit from the program.
- For BDAM:
  - Flags the record (whose address is passed to the exit in UEPFDATA) as logically deleted. The sample adopts a convention for BDAM of flagging the first byte with a logical delete mark of X'C0'.
  - Takes the normal exit from the program.
- For any other combination of access method and type:
  - Does not process the request, and the record is not flagged as deleted
  - Takes the error exit from the program.
- Normal exit from the program:
  - Makes a user trace entry if tracing is active for file control. This has trace point id X'01F1' and traces:
    - An eye-catcher 'DFH\$FCLD EXIT OK'
    - An eye-catcher 'RECORD MARKED AS DELETED'
    - The marked file control request data
    - The file control portion of the log record.
  - Returns to CICS with return code UERCLDEL, which instructs CICS to rewrite the marked record and therefore to logically delete it.
- Error exit from the program:
  - Makes a user exception trace entry regardless of the trace setting. This has trace point id X'01F2' and traces:
    - An eye-catcher 'USEREXC'
    - An eye-catcher 'DFH\$FCLD EXIT FAIL'
    - The unmarked file control request data
    - The file control portion of the log record.
  - Returns to CICS with return code UERCFAIL, which instructs CICS to regard the logical delete as having failed. (The return code UERCNORM is not intended for use by this exit. Returning UERCNORM has the same effect as UERCFAIL.)

#### **Related concepts**

"The file control recovery program sample exit programs" on page 19

## **Front End Programming Interface exits XSZARQ and XSZBRQ**

Exits XSZARQ and XSZBRQ are invoked from the Front End Programming Interface (FEPI), if FEPI is installed.

## Good morning message program exit XGMTEXT

### When invoked

Before the good morning message is transmitted.

### Exit-specific parameters

#### UEPTCTTE

Address of the terminal control table terminal entry (TCTTE). The TCTTE can be mapped using the DSECT DFHTCTTE.

#### UEPTIOA

Address of the terminal input/output area (TIOA). The TIOA can be mapped using the DSECT DFHTIOA. However, fields TIOASAL and TIOASCA are **not** programming interfaces.

### Return codes

#### UERCNORM

Continue processing.

#### UERCPURG

Task purged during XPI call.

### XPI calls

All can be used.

## HTTP client open and send exits: XWBAUTH, XWBOPEN and XWBSNDO

Exits XWBAUTH, XWBOPEN, and XWBSNDO are invoked during processing of **EXEC CICS WEB CONVERSE**, **EXEC CICS WEB OPEN**, **EXEC CICS INVOKE WEBSERVICE**, and **EXEC CICS WEB SEND** commands. They are used in making HTTP client requests from CICS as an HTTP client, which is a facility provided by CICS Web support. For details of these exits, see the *CICS Internet Guide*.

### Related concepts

“The HTTP client sample exit programs” on page 20

These sample programs are for use with the Web domain exits, XWBOPEN and XWBAUTH,.

## Intersystem communication program exits XISCONA and XISLCLQ

The two exits in the intersystem communication program allow you to control the length of intersystem queues.

There are several methods that you can use to control the length of intersystem queues. For a description of the available methods, see the *CICS Intercommunication Guide*.

### The XISCONA exit Important

It is recommended that you use the XZIQUE exit, in the VTAM working-set module, to control the length of intersystem queues, rather than XISCONA. (XZIQUE is described in “XZIQUE exit for managing MRO and APPC intersystem queues” on page 249.) XZIQUE provides more functions, and is of more general use than XISCONA (it is driven for function shipping, DPL, transaction routing, and distributed transaction processing requests, whereas XISCONA is driven only for function shipping and DPL). If you enable both exits, XZIQUE and XISCONA could both be driven for function shipping and DPL requests, which is not recommended.



If you already have an XISCONA exit program, you may be able to modify it for use at the XZIQUE exit point.

The purpose of XISCONA is to help you prevent the performance problems that can occur when function shipping or DPL requests awaiting free sessions for a connection are queued in the issuing region. The exit permits you to control the number of outstanding ALLOCATE requests by allowing you to reject any function shipping or DPL request that would otherwise be queued.

Function shipping and DPL requests for a resource-owning region are queued by default if all bound contention winner sessions are busy, so that no sessions are immediately available. If the resource-owning region is unresponsive (for example, if it is a file-owning region, it may be waiting for a system journal to be archived), the queue can become so long that the performance of the issuing region is severely impaired. Further, if the issuing region is an application-owning region, its impaired performance can spread back to the terminal-owning region.

To control the queuing of function shipping and DPL requests, use the XISCONA exit to tell CICS, whenever a session cannot be allocated immediately, whether to queue the request, or to return 'SYSIDERR' to the application. The exit works like this:

1. If the XISCONA exit program is **not** active, CICS queues the request when necessary.
2. If the exit program is active, it is invoked *only if all bound contention winner sessions are in use*. For other failures (for example, 'Mode name not found' or 'Out of service'), CICS bypasses the exit and returns to the application.
3. If it is invoked, your exit program must decide whether or not to queue the request by analyzing the statistics provided through the user exit parameter list. Your exit program could:

- Stipulate that queuing is never to be used. This is the simplest way to code the exit, and avoids complexities of tuning. It should be effective if you define enough contention winner sessions to handle the peak transaction load for the connection. If you suppress all queuing, you must specify AUTOCONNECT(YES) on the SESSIONS definition, because the queuing mechanism no longer binds sessions for you.

With this approach, a danger arises if you base your estimate of required sessions on average conditions and the transaction load subsequently varies widely; when CICS cannot use queuing to cope with the variation, users may suffer transaction abends when there is no significant problem in the resource-owning region.

- Examine the number of requests currently in the queue. The program could, for example, stop queuing when the number exceeds 120% of the maximum number of sessions. You could use this approach to cope with intermittent stoppages in the resource-owning region.

You could use a table of thresholds for the connections in your system, with values determined from previous experience of queuing problems.

Alternatively, you could use the EXEC CICS interface in a separate program to inquire about the state of the connection, and pass the information in a work area to the XISCONA exit program.

---

1. "Contention winner" is the terminology used for LU6.2 connections. The XISCONA exit applies also to MRO and LU6.1 connections: in these, the SEND sessions (defined in the session definitions) are used first for ALLOCATE requests; when all SEND sessions are in use, queuing starts.

- Examine the type of request and the resource being accessed (which can be discovered by examining the request parameter list). The program could, for example, reject file read requests but queue file updates.

**Note:** Because a failure of the exit program could affect system availability, it is recommended that you make the logic of your program as simple as possible, thus reducing the possibility of errors.

There are some problems that XISCONA cannot solve. For example, if you have specified both a large number of sessions and a large value for MXT, CICS may develop the short-on-storage (SOS) condition *before* XISCONA is invoked because there are no further sessions available.

**The sample XISCONA global user exit program, DFHXIS:** Note that there is a CICS-supplied sample exit program, DFHXIS, that shows one way of limiting the queue of ALLOCATE requests, based on the information passed to the program. For more information about the sample global user exit programs, see “Sample global user exit programs” on page 15.

#### **Related concepts**

“The function-shipping and DPL queue control sample exit program” on page 20

#### **Exit XISCONA:**

##### **When invoked**

When a function shipping or DPL request is about to be queued because all bound contention winner sessions to the remote region are in use.

**Note:** For DPL requests that are routed dynamically, the dynamic routing program is invoked before XISCONA. If there are no free sessions the routing program may choose not to queue a DPL request; in these circumstances, XISCONA is not invoked. For information about the dynamic routing of DPL requests, see Dynamically routing DPL requests, in the *CICS Intercommunication Guide*.

#### **Exit-specific parameters**

##### **UEPISPCA**

Address of a parameter list containing the following fields. You can map the parameter list using the DSECT DFHXISDS.

##### **UEPCONST**

Address of the Connection statistics record.

Connection statistics records are of type STICONS (STID value 52). Your exit program can map the record using the DSECT DFHA14DS. See notes.

##### **UEPMODST**

Address of the Mode Entry statistics record, or zero. A Mode Entry statistics record is built *only* if:

- The connection-type is LU6.2 (see field UEPCONTY).
- The profile DFHCICSF (which is always used for function shipping) defines a specific MODENAME to be used in the allocation of LU6.2 sessions.

Mode Entry statistics records are of type STICONMR (STID value 76). Your exit program can map the record (if present) using the DSECT DFHA20DS.

**UEPEIPPL**

Address of the request parameter list.

**UEPCONTY**

A 1-byte field indicating the connection-type. Possible values are:

**UEPMRO (X'80')**

Request for an MRO connection

**UEPLU6 (X'40')**

Request for an LU6.1 connection

**UEPLUC (X'20')**

Request for an LU6.2 connection.

**UEPNETNM**

An 8-character field containing the NETNAME for the connection- that is, the identifier (applid) of the remote CICS region or system.

**Note:**

1. The general format of statistics records is described in "CICS statistics record format" on page 771.
2. For a list of statistics record-types and their associated copy books, see Figure 124 on page 775.
3. For a description of the fields in Connection and Mode Entry statistics records, see CICS statistics in DSECTs and DFHSTUP report, in the *CICS Performance Guide*.

**Return codes****UERCAQUE**

Queue the request. This is the default.

**UERCAPUR**

Do not queue the request, unless local queuing is possible.

**XPI calls**

All can be used.

**Important**

There is no 'UERCNORM' return code at this exit point, because the exit is invoked after a failure. The choice is whether or not to take the system default action of queuing the request.

**The XISLCLQ exit**

XISLCLQ enables you to specify what action to take after a function shipping request fails to allocate a session with a remote system for one of the following reasons:

- The remote system is not in service.
- A connection to the remote system cannot be established.
- No sessions are immediately available, and your XISCONA exit program has specified that the request is not to be queued in the issuing region.

Note that this exit is invoked *only* if the request to be shipped is of type EXEC CICS START NOCHECK. For EXEC CICS requests other than those with the NOCHECK option (which is only available on START commands) the 'SYSIDERR' condition is raised in the application program.

You can use the exit to specify whether or not the failed request is to be locally queued, to be executed when the connection is reestablished.

### **Exit XISLCLQ:**

#### **When invoked**

After a function shipping request of type EXEC CICS START NOCHECK has failed because the remote system is not in service, a connection to the remote system cannot be established, or no sessions are immediately available, and your XISCONA exit program has specified that the request is not to be queued in the issuing region.

#### **Exit-specific parameters**

##### **UEPISPP**

Address of a parameter list that contains:

##### **UEPTCTSE**

Address of the relevant terminal control table system entry. The TCT system entry can be mapped using the DSECT DFHTCTTE.

##### **UEPXXTE**

Address of the local transaction name, or 0 if SYSID was specified in the command.

**Note:** Your program can use the transaction manager XPI call INQUIRE\_TRANDEF to obtain details of the local transaction (see "The INQUIRE\_TRANDEF call" on page 406).

##### **UEPPLIST**

Address of the parameter list for the command.

**Note:** No DSECT is provided for the above parameter list. You have to code your own DSECT to access the named fields.

#### **Return codes**

##### **UERCYSYS**

Take the system action. This is determined by the value of the LOCALQ attribute in the local TRANSACTION definition for the remote transaction:

##### **LOCALQ(YES)**

The request is queued locally.

##### **LOCALQ(NO)**

'SYSIDERR' is returned to the application program.

##### **UERCQUE**

Queue the request locally (overriding the LOCALQ(NO) attribute, if specified).

##### **UERCIGN**

Override the LOCALQ(YES) attribute, if specified, and return with 'SYSIDERR'.

## **UERCPURG**

Task purged during XPI call.

### **XPI calls**

All can be used.

### **Important**

There is no 'UERCNORM' return code at this exit point, because the exit is invoked after a failure. The choice is whether to take the system default action or to handle the error in some other way.

## **Interval control program exits XICREQ, XICEXP, and XICTENF**

You can use some XPI calls in exit programs invoked from the interval control program. However, when any of these exits are invoked for expiry analysis, any actions that delay the execution of the interval control program can have adverse effects on other transactions that are waiting for intervals to expire. You can determine whether the exits have been invoked for expiry analysis by examining the type-of-request field, TCAICTR, a copy of which is pointed to by the UEPICRQ1 exit-specific parameter.

**Note:** The XICREQ exit is invoked by internal requests made by CICS code, as well as by requests made by applications. For example, if you use the CICS extended recovery facility (XRF), the XRF surveillance program uses interval control services. DFHXRSP issues an interval control WAIT every 2 seconds; this means that any interval control exit programs are also invoked every 2 seconds.

### **Exit XICREQ**

#### **When invoked**

At the beginning of the interval control program, before request analysis.

#### **Exit-specific parameters**

##### **UEPICQID**

Address of an 8-byte field containing the request ID parameter on request. See notes below.

##### **UEPICTID**

Address of a 4-byte field containing the terminal ID, if any, specified on an EXEC CICS START command. See notes below.

##### **UEPICTI**

Address of 4 bytes containing the transaction ID specified on an EXEC CICS START command. See notes below.

##### **UEPICRQ1**

Address of a 1-byte field containing a copy of TCAICTR, the first request code field for requests to the interval control program.

##### **UEPICRQ2**

Address of a 1-byte field containing a copy of TCAICTR2, the second request code field for requests to the interval control program.

##### **UEPICRT**

Address of a 4-byte field containing the expiry time or interval, in packed decimal format. The value is in the form 0HHMMSSF, where H=hours, M=minutes, S=seconds, and F is a positive sign.

**Note:**

1. The contents of the fields addressed by UEPICQID and UEPICQID are unpredictable if the associated data items were not specified on the request. You must test the copy of TCAICTR to determine whether they contain meaningful values.
2. Your exit program can change the values of the fields addressed by UEPICQID, UEPICQID UEPICQI, and UEPICRT. Changing the values of the fields addressed by UEPICRQ1 or UEPICRQ2 has no effect.

**Return codes****UERCNORM**

Continue processing.

**UERPURG**

Task purged during XPI call.

**XPI calls**

The following must not be used:

- ADD\_SUSPEND
- DELETE\_SUSPEND
- DEQUEUE
- ENQUEUE
- RESUME
- SUSPEND
- WAIT\_MVS.

**Exit XICEXP****When invoked**

After an interval control time interval has expired.

**Exit-specific parameters****UEPICE**

Address of the interval control element (ICE) that has just expired. The ICE can be mapped using the DSECT DFHICEDS.

**Return codes****UERCNORM**

Continue processing.

**UERPURG**

Task purged during XPI call.

**XPI calls**

The following must not be used:

- ADD\_SUSPEND
- DELETE\_SUSPEND
- DEQUEUE
- ENQUEUE
- RESUME
- SUSPEND
- WAIT\_MVS.

## Exit XICTENF

### When invoked

Exit XICTENF is also invoked from the interval control program. However, this exit relates to the ‘terminal not known’ condition and so is considered in detail in “‘Terminal not known’ condition exits XALTENF and XICTENF” on page 224.

## Interval control EXEC interface program exits XICEREQ, XICERES, and XICEREQC

### XICEREQ

XICEREQ is invoked on entry to the interval control program before CICS processes an interval control request. Using XICEREQ, you can:

- Analyze the request to determine its type, the keywords specified, and their values.
- Modify any value specified by the request before the command is executed.
- Set return codes to specify that either:
  - CICS should continue with the request, modified or unmodified.
  - CICS should bypass the request. (Note that if you set this return code, you must also set up return codes for the EXEC interface block (EIB), as if you had processed the request yourself.)

**Note:** The XICEREQ exit is invoked by internal requests made by CICS code, as well as by requests made by applications.

### XICERES

XICERES is invoked by the interval control program, before CICS processes a non-terminal-related EXEC CICS START request that has been dynamically routed to this region.

Note that XICERES is invoked:

- After exit XICEREQ and before XICEREQC (if these exits are enabled). This means that:
  - If an XICEREQ exit program chooses to bypass the request, XICERES is not invoked, even if it is enabled.
  - If an XICEREQ exit program modifies the request, XICERES must deal with the modified request.
- On the *target* region—that is, the region to which the START request has been routed.
- Only if the routing region—the region on which the routing program runs—supports the “resource unavailable” condition (RESUNAVAIL). To support the “resource unavailable” condition, the routing region must be a supported release of CICS TS.
- Only if it is enabled. It is strongly recommended that you enable this exit only in application-owning regions to which non-terminal-related EXEC CICS START requests may be dynamically routed.
- By internal requests made by CICS code, as well as by requests made by applications.

The XICERES exit is *not* invoked:

- For statically-routed requests.
- For terminal-related EXEC CICS START requests. (These always execute in the terminal-owning region and cannot be routed.)

- For dynamically-routed *transactions*—only dynamically-routed (non-terminal-related) START requests cause the exit to be invoked. Thus, a dynamically-routed transaction that was initiated by a terminal-related EXEC CICS START command does not cause the exit to be invoked.
- If it is disabled.
- If an XICEREQ exit program chooses to bypass the request.

You can use XICERES to check that all resources required by the transaction to be started are available on the target region. If, for example, the transaction is disabled, or a required file is missing, your exit program can give the distributed routing program the opportunity to route the request to a different region. To do this, set a return code of UERCRESU. This causes CICS to:

1. Set the DYRERROR field of the distributed routing program's communications area to 'F'—resource unavailable.
2. Reinvoke the routing program, on the routing region, for route selection failure.
3. Return a RESUNAVAIL condition on the EXEC CICS START command executed by the mirror on the target region. (This condition is *not* returned to the application program.)

CICS ignores any changes made by the exit program to the values of any of the exit parameters. Your exit program can set a return code, but not change any parameters.

For guidance information about dynamically routing non-terminal-related EXEC CICS START requests, see the *CICS Intercommunication Guide*. For information about writing a distributed routing program to route non-terminal-related EXEC CICS START REQUESTS, see “Routing non-terminal-related START requests” on page 637.

### **XICEREQC**

XICEREQC is invoked after an interval control program request has completed. Using XICEREQC, you can:

- Analyze the request, to determine its type, the keywords specified, and their values.
- Set return codes for the EIB.

**Note:** The XICEREQC exit is invoked by internal requests made by CICS code, as well as by requests made by applications.

## **Parameters passed to each of the exits**

CICS passes ten parameters to these exits as follows:

- The address of the command-level parameter structure (UEPCLPS)
- The address of a token (UEPICTOK) used to pass 4 bytes of data from XICEREQ to XICEREQC
- The addresses of copies of six pieces of return code, resource, date, and time information from the EIB
- The address of a token (UEPTSTOK) that is valid throughout the life of a task
- The address of an exit recursion count (UEPRECUR).

## **Exit XICEREQ**

### **When invoked**

Before CICS processes an interval control API request.



## Exit-specific parameters

### UEPCLPS

Address of the command-level parameter structure. See “The UEPCLPS exit-specific parameter” on page 152.

### UEPICTOK

Address of a 4-byte token to be passed to XICEREQC. This allows you, for example, to pass a work area to exit XICEREQC.

### UEPRCODE

Address of a 6-byte hexadecimal copy of the EIB return code ‘EIBRCODE’. For details of EIB return codes, refer to EIB fields, in the *CICS Application Programming Reference* manual.

### UEPRES

Address of a 4-byte binary copy of the EIB response code ‘EIBRESP’.

### UEPRES2

Address of a 4-byte binary copy of the EIB response code ‘EIBRESP2’.

### UEPTSTOK

Address of a 4-byte token that is valid throughout the life of a task. See “Using the task token UEPTSTOK” on page 161.

### UEPRECUR

Address of a halfword recursion counter. The counter is set to 0 when the exit is first invoked, and is incremented for each recursive call.

### UEPRSRCE

Address of an 8-character copy of the EIB resource value, EIBRSRCE.

### UEPDATE

Address of a fullword copy of the EIB date value, EIBDATE.

### UEPTIME

Address of a fullword copy of the EIB time value, EIBTIME.

## Return codes

### UERCNORM

Continue processing.

### UERCBYP

The interval control EXEC interface program should ignore this request.

### UERCPURG

Task purged during XPI call.

## XPI calls

All can be used. You can also use EXEC CICS API commands at this user exit.

Although the exit permits the use of XPI GETMAIN and FREEMAIN calls, you are recommended to use the EXEC CICS GETMAIN and FREEMAIN commands instead.

## API and SPI commands

All can be used, except for:

EXEC CICS SHUTDOWN  
EXEC CICS XCTL

**Note:** Take care when issuing recursive commands not to cause a loop. For example, it is your responsibility to avoid entering a loop when an interval control request is issued from the XICERREQ exit. Use of the recursion counter UEPRECUR is recommended.

## Exit XICERES

### When invoked

By the interval control program, before processing of a non-terminal-related EXEC CICS START request that has been dynamically routed to this region, where the routing region supports the “resource unavailable” condition (RESUNAVAIL).

### Exit-specific parameters

**Note:** CICS ignores any changes made by the exit program to the values of any of the exit parameters. Your exit program can set a return code, but not change any parameters.

#### UEPCLPS

Address of the command-level parameter structure. See “The UEPCLPS exit-specific parameter” on page 152.

#### UEPICTOK

Address of a 4-byte token to be passed to XICEREQC.

#### UEPRCODE

Address of a 6-byte hexadecimal copy of the EIB return code ‘EIBRCODE’. For details of EIB return codes, refer to EIB fields, in the *CICS Application Programming Reference* manual.

#### UEPRESP

Address of a 4-byte binary copy of the EIB response code ‘EIBRESP’.

#### UEPRESP2

Address of a 4-byte binary copy of the EIB response code ‘EIBRESP2’.

#### UEPTSTOK

Address of a 4-byte token that is valid throughout the life of a task. See “Using the task token UEPTSTOK” on page 161.

#### UEPRECUR

Address of a halfword recursion counter. Because the XICERES exit can never be called recursively in the same transaction, the value of this field is always 0.

#### UEPRSRCE

Address of an 8-character copy of the EIB resource value, EIBRSRCE.

#### UEPDATE

Address of a fullword copy of the EIB date value, EIBDATE.

#### UEPTIME

Address of a fullword copy of the EIB time value, EIBTIME.

### Return codes

**UERCNORM**

Continue processing.

**UERPURG**

Task purged during XPI call.

**UERCRESU**

A required resource is unavailable. Setting this value causes CICS to reject the routed request, and to return a value of 'F' (resource unavailable) in the DYRERROR field of the routing program's communications area.

**XPI calls**

All can be used. You can also use EXEC CICS API commands at this user exit.

Although the exit permits the use of XPI GETMAIN and FREEMAIN calls, you are recommended to use the EXEC CICS GETMAIN and FREEMAIN commands instead.

**API and SPI commands**

All except EXEC CICS SHUTDOWN and EXEC CICS XCTL can be used.

**Exit XICEREQC****When invoked**

After an interval control API request has completed, and before return from the interval control EXEC interface program.

**Exit-specific parameters****UEPCLPS**

Address of the command-level parameter structure. See "The UEPCLPS exit-specific parameter" on page 152.

**UEPICTOK**

Address of a 4-byte token passed from XICEREQ. This allows XICEREQ to, for example, pass a work area to XICEREQC.

**UEPRCODE**

Address of a 6-byte hexadecimal copy of the EIB return code 'EIBRCODE'. For details of EIB return codes, refer to EIB fields, in the *CICS Application Programming Reference* manual.

**UEPRESP**

Address of a 4-byte binary copy of the EIB response code 'EIBRESP'.

**UEPRESP2**

Address of a 4-byte binary copy of the EIB response code 'EIBRESP2'.

**UEPTSTOK**

Address of a 4-byte token that is valid throughout the life of a task. See "Using the task token UEPTSTOK" on page 161.

**UEPRECUR**

Address of a halfword recursion counter. The counter is set to 0 when the exit is first invoked, and is incremented for each recursive call.

**UEPRSRCE**

Address of an 8-character copy of the EIB resource value, EIBRSRCE.

**UEPDATE**

Address of a fullword copy of the EIB date value, EIBDATE.

**UEPTIME**

Address of a fullword copy of the EIB time value, EIBTIME.

**UEP\_IC\_REMOTE\_SYSTEM**

If the request is to be sent to a remote region, is the address of an area containing the 4-byte name of the remote region. (The remote region may have been specified by, for example, the SYSID option of the START command, work-load management, or the REMOTESYSTEM option of the TRANSACTION definition.)

If the request is to be executed on the local region, this parameter is the address of a 4-byte area containing blanks.

**UEP\_IC\_REMOTE\_NAME**

If the transaction is to be executed in a remote system, is the address of an area containing the name of the transaction, as it is known in the remote system.

The remote system may be another CICS region, or an IMS system. If UEP\_IC\_REMOTE\_SYSTEM names a CICS region, the name is 1 through 4 characters long. If UEP\_IC\_REMOTE\_SYSTEM names an IMS system, the name is 1 through 8 characters long. IMS uses 8-character names: if UEP\_IC\_REMOTE\_NAME has fewer than 8 characters, IMS translates it into a useable format.

**Return codes****UERCNORM**

Continue processing.

**UERCPURG**

Task purged during XPI call.

**XPI calls**

All can be used.

Although the exit permits the use of XPI GETMAIN and FREEMAIN calls, you are recommended to use the EXEC CICS GETMAIN and FREEMAIN commands instead.

**API and SPI commands**

All can be used, except for:  
EXEC CICS SHUTDOWN  
EXEC CICS XCTL

**Note:** Take care when issuing recursive commands. For example, you must avoid entering a loop when issuing an interval control request from the XICEREQC exit. Use of the recursion counter UEPRECUR is recommended.

**The command-level parameter structure**

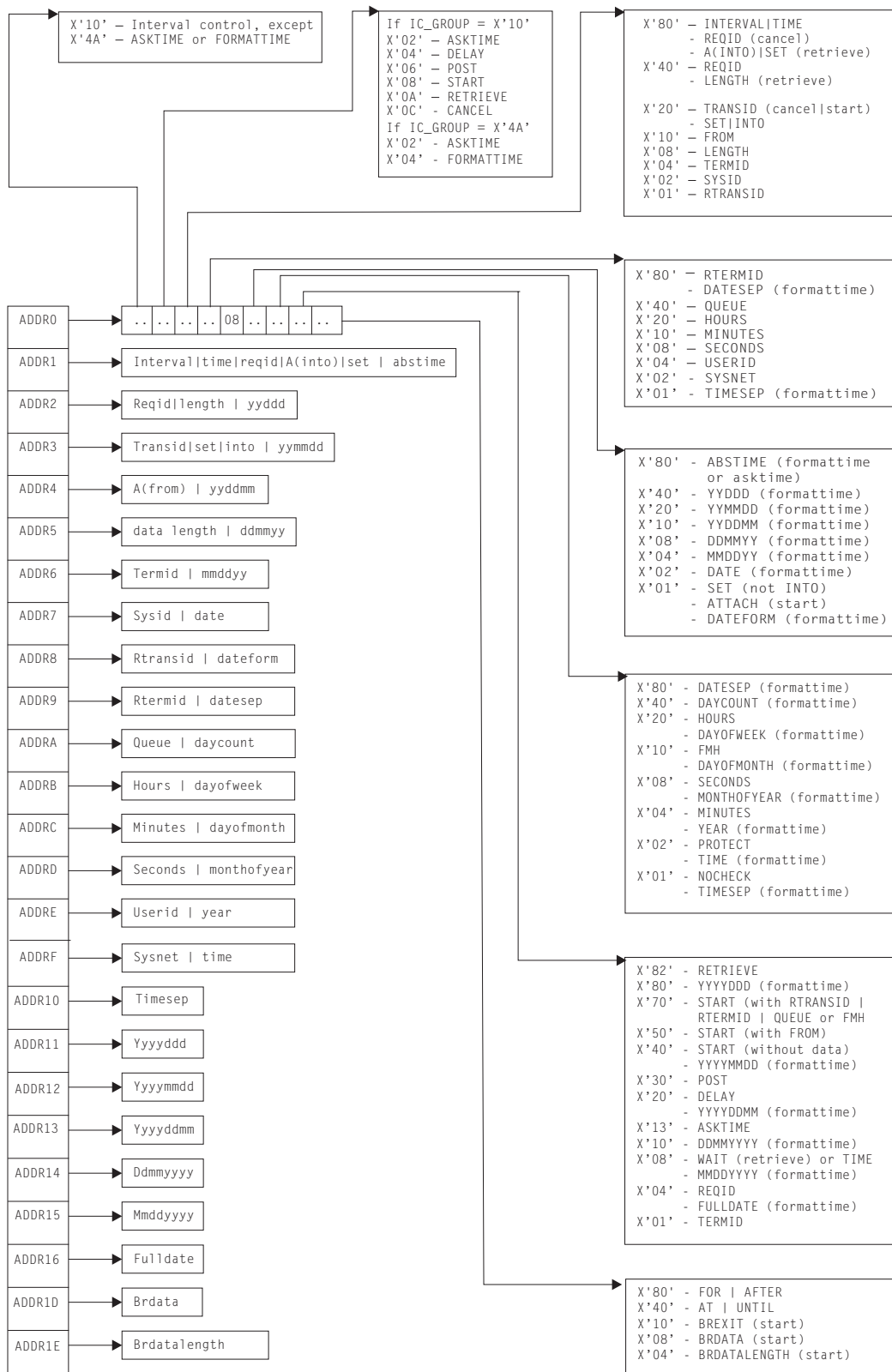

Figure 1. The command-level parameter structure for interval control

The command-level parameter structure consists of a series of addresses. The first address points to the EXEC interface descriptor (EID), which consists of a 9-byte area that describes the type of request and identifies each keyword specified with

the request. The remaining addresses point to pieces of data associated with the request. For example, the second address points to the interval for START requests.

You can examine the EID to determine the type of request and the keywords specified. You can examine the other parameters in the list to determine the values of the keywords. You can also modify values of keywords specified on the request. For example, you could change the SYSID specified in the request.

### **End of parameter list indicator**

The high-order bit is set on in the last address set in the parameter list to indicate that it is the last one in the list. On return from your user exit program, CICS scans the parameter list for the high-order bit to find the last parameter. Therefore, if you modify the length of the parameter list, you must also reset the high-order bit to indicate which is the new last address.

For example, if the parameter list specifies only the first four addresses (IC\_ADDR0, the address of the EID, to IC\_ADDR3, the address of the name of the transaction named in a START request), the high-order bit is set on in IC\_ADDR3. If you extend the parameter list by setting the address of a SYSID in IC\_ADDR7, you must unset the high-order bit in IC\_ADDR3 and set it on in IC\_ADDR7 instead.

The maximum size of parameter list is supplied to the exit, thus allowing your exit program to add any parameters not already specified without needing to first obtain more storage.

The original parameter list, as it was before XICEREQ was invoked, is restored after the completion of XICEREQC. It follows that the execution diagnostic facility (EDF) displays the original command before **and** after execution: **EDF does not display any changes made by the exit.**

### ***The UEPCLPS exit-specific parameter:***

The UEPCLPS exit-specific parameter is included in both exit XICEREQ and exit XICEREQC. It is the address of the command-level parameter structure. The command-level parameter structure contains 26 addresses, IC\_ADDR0 through IC\_ADDR1F. It is defined in the DSECT IC\_ADDR\_LIST, which you should copy into your exit program by including the statement COPY DFHICUED.

The command-level parameter list is made up as follows:

#### **IC\_ADDR0**

is the address of a 9-byte area called the EXEC interface descriptor (EID), which is made up as follows:

- **IC\_GROUP**
- **IC\_FUNCT**
- **IC\_BITS1**
- **IC\_BITS2**
- **IC\_BITS3**
- **IC\_EIDOPT5**
- **IC\_EIDOPT6**
- **IC\_EIDOPT7**
- **IC\_EIDOPT8**

## IC\_GROUP

**X'10'** This is an interval control request.

**X'4A'** This is an ASKTIME or FORMATTIME command.

## IC\_FUNCT

One byte that defines the type of request.

If IC\_GROUP = X'10':

**X'02'** ASKTIME

**X'04'** DELAY

**X'06'** POST

**X'08'** START

**X'0A'** RETRIEVE

**X'0C'** CANCEL

If IC\_GROUP = X'4A':

**X'02'** ASKTIME

**X'04'** FORMATTIME

## IC\_BITS1

Existence bits that define which arguments were specified. To obtain the argument associated with a keyword, you need to use the appropriate address from the command-level parameter structure. Before using this address, you must check the associated existence bit. If the existence bit is set off, the argument was not specified in the request and the address should not be used.

**X'80'** Set if the request contains INTERVAL or TIME arguments, or if a CANCEL request specifies REQID, or if a RETRIEVE request specifies SET or INTO. If set, **IC\_ADDR1** is meaningful.

**X'40'** Set if the request other than CANCEL specifies REQID or if a RETRIEVE request specifies LENGTH. If set, **IC\_ADDR2** is meaningful.

**X'20'** Set if the request specifies TRANSID or if a request other than RETRIEVE specifies SET or INTO. If set, **IC\_ADDR3** is meaningful.

**X'10'** Set if the request specifies FROM. If set, **IC\_ADDR4** is meaningful.

**X'08'** Set if a request other than RETRIEVE specifies LENGTH. If set, **IC\_ADDR5** is meaningful.

**X'04'** Set if the request specifies TERMID. If set, **IC\_ADDR6** is meaningful.

**X'02'** Set if the request specifies SYSID. If set, **IC\_ADDR7** is meaningful.

**X'01'** Set if the request specifies RTRANSID. If set, **IC\_ADDR8** is meaningful.

## IC\_BITS2

Further argument existence bits.

- X'80'** Set if the request specifies RTERMID, or if a FORMATTIME request specifies DATESEP. If set, **IC\_ADDR9** is meaningful.
- X'40'** Set if the request specifies QUEUE. If set, **IC\_ADDRA** is meaningful.
- X'20'** Set if the request specifies HOURS. If set, **IC\_ADDRB** is meaningful.
- X'10'** Set if the request specifies MINUTES. If set, **IC\_ADDRD** is meaningful.
- X'08'** Set if the request specifies SECONDS. If set, **IC\_ADDRD** is meaningful.
- X'04'** Set if the request specifies USERID. If set, **IC\_ADDRE** is meaningful.
- X'02'** Set if the request specifies SYSNET. If set, **IC\_ADDRF** is meaningful.
- X'01'** Set if a FORMATTIME request specifies TIMESEP. If set, **IC\_ADDR10** is meaningful.

### **IC\_BITS3**

One byte not used by interval control.

### **IC\_EIDOPT5**

Indicates whether certain keywords were specified on the request.

- X'80'** ABSTIME was specified on a FORMATTIME or ASKTIME command.
- X'40'** YYDDD was specified on a FORMATTIME command.
- X'20'** YYMMDD was specified on a FORMATTIME command.
- X'10'** YYDDMM was specified on a FORMATTIME command.
- X'08'** DDMMYY was specified on a FORMATTIME command.
- X'04'** MMDDYY was specified on a FORMATTIME command.
- X'02'** DATE was specified on a FORMATTIME command.
- X'01'** On a RETRIEVE command, SET (and not INTO) was specified. On a START command, ATTACH was specified. On a FORMATTIME command, DATEFORM was specified. You cannot modify this field in your user exit.

### **IC\_EIDOPT6**

Existence bits that indicate whether certain keywords were specified on the request.

- X'80'** DATESEP was specified on a FORMATTIME command.
- X'40'** DAYCOUNT was specified on a FORMATTIME command.
- X'20'** DAYOFWEEK was specified on a FORMATTIME command, or HOURS was specified.
- X'10'** DAYOFMONTH was specified on a FORMATTIME command, or FMH was specified.
- X'08'** MONTHOFYEAR was specified on a FORMATTIME command, or SECONDS was specified.



- X'04'** YEAR was specified on a FORMATTIME command, or MINUTES was specified.
- X'02'** TIME was specified on a FORMATTIME command, or PROTECT was specified.
- X'01'** TIMESEP was specified on a FORMATTIME command, or NOCHECK was specified.

#### **IC\_EIDOPT7**

Indicates whether certain functions or keywords were specified on the request.

- X'F0'** CANCEL specified.
- X'82'** RETRIEVE specified.
- X'80'** YYYYDD specified on a FORMATTIME command.
- X'40'** YYYYMMDD specified on a FORMATTIME command, or START specified.
- X'30'** POST specified.
- X'20'** YYYYDDMM specified on a FORMATTIME command, or DELAY, RTRANSID, RTERMID, or QUEUE specified, and/or FMH.
- X'13'** ASKTIME specified.
- X'10'** DDMMYYYY specified on a FORMATTIME command, or FROM, RTRANSID, or RTERMID specified, and/or QUEUE.
- X'08'** MMDDYYYY specified on a FORMATTIME command, or TIME or WAIT specified.
- X'04'** FULLDATE specified on a FORMATTIME command, or REQID specified.
- X'01'** TERMID specified.

#### **IC\_EIDOPT8**

Indicates whether certain keywords were specified on the request.

- X'80'** FOR or AFTER specified.
- X'40'** AT or UNTIL specified.
- X'10'** BREXIT specified.
- X'08'** BRDATA specified.
- X'04'** BRDATALENGTH specified.
- X'02'** CHANNEL specified on a START command.

#### **IC\_ADDR1**

is the address of one of the following:

- An 8-byte area containing the value of the INTERVAL keyword (or TIME keyword if **IC\_EIDOPT7** indicates that TIME is specified).
- An 8-byte area containing the value of REQID (if the request is CANCEL).
- An 8-byte area containing the value of the ABSTIME keyword.
- Data returned for INTO (if the request is RETRIEVE, and if **IC\_EIDOPT5** indicates that this is not SET).
- A 4-byte address returned for SET (if the request is RETRIEVE and **IC\_EIDOPT5** indicates that this is SET).

**IC\_ADDR2**

is the address of one of the following:

- An 8-byte area containing the value of REQID (if the request is DELAY, POST or START).
- A halfword containing the value of LENGTH (if the request is RETRIEVE).

**Warning:** For requests that specify INTO, do not change the value of LENGTH to a value greater than that specified by the application. To do so causes a storage overlay in the application.

- An area containing the value of YYDD.

**IC\_ADDR3**

is the address of one of the following:

- An area containing the value of TRANSID (if the request is CANCEL or START).
- A 4-byte address returned for SET (if the request is START or POST and **IC\_EIDOPT5** indicates that this is SET).
- An area containing the value of YYMMDD.

**IC\_ADDR4**

is the address of one of the following:

- An area containing the data from FROM.
- An area containing the value of YYDDMM.

**IC\_ADDR5**

is the address of one of the following:

- An area containing the halfword value of LENGTH.

**Warning:** For requests that specify INTO, do not change the value of LENGTH to a value greater than that specified by the application. To do so causes a storage overlay in the application.

- An area containing the value of DDMMYY.

**IC\_ADDR6**

is the address of one of the following:

- An area containing the value of TERMID.
- An area containing the value of MMDDYY.

**IC\_ADDR7**

is the address of one of the following:

- An area containing the value of SYSID.
- An area containing the value of DATE.

**IC\_ADDR8**

is the address of one of the following:

- An area containing the value of RTRANSID.
- An area containing the value of DATEFORM.

**IC\_ADDR9**

is the address of one of the following:

- An area containing the value of RTERMID.
- An area containing the value of DATESEP.

**IC\_ADDRA**

is the address of one of the following:

- An area containing the value of QUEUE.

- A fullword containing the value of DAYCOUNT.

**IC\_ADDRB**

is the address of one of the following:

- An area containing the value of HOURS.
- A fullword containing the value of DAYOFWEEK.

**IC\_ADDR C**

is the address of one of the following:

- An area containing the value of MINUTES.
- A fullword containing the value of DAYOFMONTH.

**IC\_ADDRD**

is the address of one of the following:

- An area containing the value of SECONDS.
- A fullword containing the value of MONTHOFYEAR.

**IC\_ADDRE**

is the address of one of the following:

- An area containing the value of USERID.
- A fullword containing the value of YEAR.

**IC\_ADDRF**

is the address of one of the following:

- An 8–byte area containing the value of SYSNET.
- An area containing the value of TIME.

**IC\_ADDR10**

is the address of a 1–byte area containing the value of TIMESEP.

**IC\_ADDR11**

is the address of an area containing the value of YYYYDDD.

**IC\_ADDR12**

is the address of an area containing the value of YYYYMMDD.

**IC\_ADDR13**

is the address of an area containing the value of YYYYDDMM.

**IC\_ADDR14**

is the address of an area containing the value of DDMMYYYY.

**IC\_ADDR15**

is the address of an area containing the value of MMDDYYYY.

**IC\_ADDR16**

is the address of an area containing the value of FULLDATE.

**IC\_ADDR1D**

is the address of an area containing the value of BRDATA.

**IC\_ADDR1E**

is the address of a fullword containing the value of BRDATALENGTH.

**IC\_ADDR1F**

is the address of a 16-byte area containing the value of CHANNEL.

**Modifying fields in the command-level parameter structure:** Some fields that are passed to interval control are used as input to the request, some are used as output fields, and some are used for both input and output. The method your user exit program uses to modify a field depends on the usage of the field.

The following are always input fields:

- INTERVAL
- TIME
- REQID
- FROM
- TERMID
- SYSID
- HOURS
- MINUTES
- SECONDS
- USERID
- CHANNEL

The following are always output fields:

- DATE
- DATEFORM
- DAYCOUNT
- DAYOFMONTH
- DAYOFWEEK
- DDMMYY
- DDMMYYYY
- FULLDATE
- INTO
- MMDDYY
- MMDDYYYY
- MONTHOFYEAR
- SET
- TIME
- YEAR
- YYDDD
- YYDDMM
- YYMMDD
- YYYYDDD
- YYYYDDMM
- YYYYMMDD

The following are input fields on a START request and output fields on a RETRIEVE request:

- RTRANSID
- RTERMID
- QUEUE

LENGTH is an input field on a START request, an output field on a RETRIEVE with SET specified, and an input/output field on a RETRIEVE with INTO specified.

ABSTIME is an input field on a FORMATTIME request, and an output field on an ASKTIME request. DATESEP and TIMESEP can be input fields on a FORMATTIME request.

**Modifying input fields:** The correct method of modifying an input field is to create a new copy of it, and to change the address in the command-level parameter list to point to your new data.

**Note:** You must never modify an input field by altering the data that is pointed to by the command-level parameter list. To do so would corrupt storage belonging to the application program and would cause a failure when the program attempted to reuse the field.

**Modifying output fields:** The technique described in “Modifying input fields” is not suitable for modifying output fields. (The results would be returned to the new area instead of the application’s area, and would be invisible to the application.)

An output field is modified by altering the data that is pointed to by the command-level parameter list. In the case of an output field, you can modify the application’s data in place, because the application is expecting the field to be modified anyway.

**Modifying the EID:** It is not possible to modify the EID to make major changes to requests, such as changing a DELAY request to a START request.

However, you can make minor changes to requests, such as turning on the existence bit for SYSID so that the request can be changed into one that is shipped to a remote system.

Some interval control commands use 2 bits in the EID to indicate a single keyword; the EXEC CICS START command, for example, uses 2 bits to indicate TERMID. The first bit, in IC\_BITS1, indicates that ADDR6 in the command parameter list is valid (ADDR6 points to TERMID) and the second, in IC\_EIDOPT7, is the keyword existence bit to show that the TERMID keyword was specified on the command.

Where this occurs you must ensure that both bit settings are changed (consistently) if you wish to modify these commands from within a user exit program, or the results will be unpredictable.

The list that follows shows the bits in the EID that **can** be modified. Any attempt to modify any other part of the EID is ignored.

#### IC\_BITS1

- X'80'** The existence bit for REQID (if the request is CANCEL)
- X'40'** The existence bit for LENGTH (if the request is RETRIEVE) or REQID
- X'10'** The existence bit for FROM
- X'08'** The existence bit for LENGTH
- X'04'** The existence bit for TERMID
- X'02'** The existence bit for SYSID
- X'01'** The existence bit for RTRANSID.

#### IC\_BITS2

- X'80'** The existence bit for RTERMID

- X'40' The existence bit for QUEUE
- X'20' The existence bit for HOURS
- X'10' The existence bit for MINUTES
- X'08' The existence bit for SECONDS.

#### IC\_EIDOPT6

- X'20' The secondary existence bit for HOURS
- X'10' The existence bit for FMH
- X'08' The secondary existence bit for SECONDS
- X'04' The secondary existence bit for MINUTES
- X'02' The existence bit for PROTECT
- X'01' The existence bit for NOCHECK.

#### IC\_EIDOPT7

Bits in IC\_EIDOPT7 should only be modified within the same functional group - that is, only those existence bits defined as valid for a START request should be set on a START request.

#### **ASKTIME requests**

- X'13' ASKTIME request. This value is fixed for all ASKTIME requests, and should not be modified.

#### **DELAY requests**

- X'20' DELAY request
- X'08' TIME specified
- X'04' REQID specified.

#### **POST requests**

- X'30' POST request
- X'08' TIME specified
- X'04' REQID specified.

#### **START requests**

- X'40' START request (without DATA)
- X'50' START with DATA request
- X'70' START with one or more of RTRANSID, RTERMID, QUEUE, or FMH specified.
- X'08' TIME specified
- X'04' REQID specified
- X'01' TERMID specified.

#### **RETRIEVE requests**

- X'82' RETRIEVE request.

#### **CANCEL requests**

- X'F0' CANCEL request
- X'04' REQID specified.

## IC\_EIDOPT8

X'20' Unused by CICS.

The EID is reset to its original value before return to the application program. That is, changes made to the EID are retained for the duration of the interval control request only.

**Note:** Your user exit program is prevented from making major changes to the EID. However, you must take great care when making the minor modifications that **are** permitted.

**Using the interval control request token UEPICTOK:** UEPICTOK provides the address of a 4-byte area that you can use to pass information between the XICERREQ and XICEREQC user exits for the same interval control request. For example, the address of a piece of storage obtained by the XICERREQ user exit, which is to be freed by the XICEREQC exit, can be passed in the UEPICTOK field.

**Using the task token UEPTSTOK:** UEPTSTOK provides the address of a 4-byte area that you can use to pass information between successive interval control requests in the same task. (By contrast, UEPICTOK is usable only for the duration of a single interval control request, because its contents may be destroyed at the end of the request.) For example, if you need to pass information between successive invocations of the XICERREQ exit, UEPTSTOK provides a means of doing this.

### **The EIB:**

Copies of EIBRSRCE, EIBRCODE, EIBRESP, and EIBRESP2 are passed to the exit, so that you can:

- Modify or set completion and resource information in XICERREQ and XICEREQC
- Examine completion and resource information in XICEREQC.

You can update the copies of EIBRSRCE, EIBRCODE, EIBRESP, and EIBRESP2 that you are given in the parameter list. Interval control copies your values into the real EIB after the completion of XICEREQC; or if you specify a return code of 'bypass' in XICERREQ.

You must set valid interval control responses. You must set all three of EIBRCODE, EIBRESP, and EIBRESP2 to a consistent set of values, such as would be set by CICS interval control to describe a valid completion. **CICS does not police the consistency of EIBRCODE, EIBRESP, and EIBRESP2.** However, if EIBRCODE is set to a non-zero value and EIBRESP is set to zero, CICS overrides EIBRESP with a non-zero value. To aid you in setting the values of EIBRCODE, EIBRESP, and EIBRESP2, the values used by interval control are specified in DFHICUED.

**Example of how XICERREQ and XICEREQC can be used:** XICERREQ and XICEREQC can be used for a variety of purposes. One example of a possible use is given below.

In this example, XICERREQ and XICEREQC are used to route START requests to a number of different CICS regions to provide a simple load balancing mechanism. The example shows only the capabilities of the exits; it is not intended to indicate an ideal way of achieving the function.

### **In XICERREQ:**

1. Scan the global work area (GWA) to locate a suitable CICS region (for example, the region currently processing the least number of START requests).
2. Having decided which system to route the request to, increment the use count for this system.
3. Obtain a 4-byte area in which to store the SYSID for this request. This can be allocated from the GWA to avoid issuing a GETMAIN. If the area is obtained by issuing a GETMAIN, set UEPICTOK to the address of the storage obtained.
4. Set IC\_ADDR7 to be the address of the 4-byte area so that XICEREQC can also use this area.
5. If setting IC\_ADDR7 now makes it the last address, set the high-order bit in the address, and reset the high-order bit in what was previously the last address.
6. Set the X'02' existence bit on in IC\_BITS1 to indicate that a SYSID is specified.
7. Return to CICS.

**In XICEREQC:**

1. Scan the global work area (GWA) and locate the entry for the CICS region specified in the SYSID parameter.
2. Decrement the use count for this system.
3. If a GETMAIN was issued in XICEREQ to obtain an area to hold the SYSID, issue a FREEMAIN for the address held in UEPICTOK.
4. Return to CICS.

**Example and sample programs**

CICS supplies two programs for use at the XICEREQ exit:

- DFH\$XTSE, supplied as a softcopy listing only (not as a source code file), is an example program that shows how to modify fields in the command-level parameter structure passed to all the EXEC interface exits. DFH\$XTSE is listed on page Appendix F, “The example program for the XTSEREQ global user exit, DFH\$XTSE,” on page 877.
- DFH\$ICCN is a sample program for use in a distributed routing environment, where you want to cancel a previously-issued interval control request but have no way of knowing to which region to direct the CANCEL. For examples of situations which DFH\$ICCN is designed to cope with, see Canceling interval control requests, in the *CICS Intercommunication Guide*.

**Related concepts**

“The interval control EXEC interface sample exit program” on page 23

**Loader domain exits XLDLOAD and XLDELETE**

There are two global user exits in the loader domain. XLDLOAD is invoked when a new instance of a program is loaded into storage, before the program is made available for use.

XLDELETE is invoked after an instance of a program is released by CICS and before the program is freed from storage.

For LPA-resident programs, the exits are still invoked when a program is acquired or released, even though the program is not physically loaded or freed.



These are both information-only exits. Any changes made to the exit parameters by the exit program are ignored by CICS, as is any return code which it sets.

## **Exit XLDLOAD**

### **When invoked**

After an instance of a program is brought into storage, and before the program is made available for use.

### **Exit-specific parameters**

#### **UEPPROGN**

Address of an 8-character field containing the name of the program that is being loaded.

#### **UEPPROGL**

Address of a 4-byte field containing the length, in bytes, of the program that is being loaded.

#### **UEPLDPT**

Address of a 4-byte field containing the address at which the program has been loaded.

#### **UEPENTRY**

Address of a 4-byte field containing the address of the program's entry point.

#### **UEPTRANID**

Zero, or the address of a 4-byte field containing the transaction ID which applied when the exit was invoked.

#### **UEPUSER**

Zero, or the address of an 8-byte field containing the userid in control at the time the exit was invoked.

#### **UEPTERM**

Zero, or the address of a 4-byte field containing the terminal name associated with the transaction under which the exit was invoked.

#### **UEPPROG**

Zero, or the address of an 8-character field containing the name of the program that was in control at the time the exit was invoked.

### **Return codes**

#### **UERCNORM**

Continue processing.

### **XPI calls**

Must not be used.

### **API and SPI calls**

Must not be used.

## **Exit XLDELETE**

### **When invoked**

After an instance of a program is released by CICS, and before the program is freed from storage.

### **Exit-specific parameters**

#### **UEPPROGN**

Address of an 8-character field containing the name of the program that is being freed.

**UEPPROGL**

Address of a 4-byte field containing the length, in bytes, of the program that is being freed.

**UEPLDPT**

Address of a 4-byte field containing the address at which the program resides in storage.

**UEPENTRY**

Address of a 4-byte field containing the address of the program's entry point.

**UEPTRANID**

Zero, or the address of a 4-byte field containing the transaction ID which applied when the exit was invoked.

**UEPUSER**

Zero, or the address of an 8-byte field containing the userid in control at the time the exit was invoked.

**UEPTERM**

Zero, or the address of a 4-byte field containing the terminal name associated with the transaction under which the exit was invoked.

**UEPPROG**

Zero, or the address of an 8-character field containing the name of the program that was in control at the time the exit was invoked.

**Return codes****UERCNORM**

Continue processing.

**XPI calls**

Must not be used.

**API and SPI calls**

Must not be used.

## Log manager domain exit XLGSTRM

There is one exit point, XLGSTRM, in the log manager domain.

You can use XLGSTRM to modify a request to MVS to create a new log stream. You can change the model log stream name and other parameters before they are passed to the MVS system logger.

If a log stream connection request from CICS to the MVS system logger fails because the log stream is not defined to MVS, CICS issues a request to the MVS system logger to create the log stream dynamically, using a model log stream definition.

The model log stream name that CICS passes to MVS depends on whether the journal name refers to the system log or a CICS general log, as follows:

**CICS system logs**

*&sysname.LSN\_last\_qualifier.MODEL*

*&sysname* is the MVS symbol that resolves to the system name of the MVS image. *LSN\_last\_qualifier* is the last qualifier of the log stream name as specified on the JOURNALMODEL resource definition.

If you do not provide a JOURNALMODEL resource definition for DFHLOG and DFHSHUNT, or if you use the CICS definitions supplied in group DFHLGMOD, the model log stream names default to *&sysname.DFHLOG.MODEL* and *&sysname.DFHSHUNT.MODEL*.

For example, if a CICS region issues a request to create a log stream for its primary system log, and CICS is running in an MVS image with a sysid of MV10 and using the default JOURNALMODEL definition, the MVS system logger expects to find a model log stream named MV10.DFHLOG.MODEL.

If the system name of the MVS image starts with a numeric character and is less than 8 characters long, CICS prefixes it with a “C”, so that the model log stream name becomes *C&sysname.LSN\_last\_qualifier*. This is because the MVS system logger rejects log stream names that begin with a numeric. If the system name of the MVS image starts with a numeric but is already 8 characters long (the maximum), CICS does not add the “C” prefix, which means that the MVS system logger will reject the default model log stream name. However, your global user exit program can change the model log stream name.

### CICS general logs

*LSN\_qualifier\_1.LSN\_qualifier2.MODEL*. The defaults for these two qualifiers are the CICS region userid and the CICS region APPLID, but they can be user-defined values specified in a JOURNALMODEL resource definition.

For example, if the CICS region userid is CICSHT## and the APPLID is CICSHTA1, the default model name is CICSHT##.CICSHTA1.MODEL.

The following information is passed to an XLGSTRM global user exit program:

- The name of the log stream to be defined
- The default model log stream name
- A system log flag
- The MVS system logger IXGINVNT parameter list.

Your exit program can amend the model stream name by updating the field pointed to by the UEPMLSN exit-specific parameter. Here is an example of how your exit program can change the model stream name:

```
L      R3,UEPMLSN          R3 = address of stream name
MVC   0(26,R3),=CL26'NEW.MODEL.NAME'
```

By updating the field pointed to by the UEPIXG parameter, your exit program can amend the IXGINVNT macro parameter list used by the MVS system logger to define the log stream. Use the IXGINVNT MF=M form of the macro, which allows the exit to specify the log stream attributes to be used. Here is an example of how your exit program can change the structure name:

```
L      R9,UEPIXG
IXGINVNT REQUEST=DEFINE,
        TYPE=LOGSTREAM,
        STRUCTNAME=NEW_STRUCTURE,
        MF=(M,(R9),NOCHECK)
...
NEW_STRUCTURE DC CL16'LOG_SYSTEST_009'
```

You do not need to code the list and execute forms of the IXGINVNT macro, or include the IXGCON or IXGANSAA macros in your exit—these are provided by the CICS code which actually issues the DEFINE request.

For information about the IXGINVNT service, see the *OS/390 MVS Authorized Assembler Services* manual.

An XLGSTRM global user exit program can set explicit attributes for the log stream definition, and can also set a return code that causes the log stream definition to be bypassed.

**Note:** If you want XLGSTRM to intercept the connection of the CICS system logs, you must enable your exit program in a first-phase PLT program.

## Exit XLGSTRM

### When invoked

After the CICS log manager detects that a log stream does not exist and before calling the MVS system logger to define the log stream dynamically.

### Exit-specific parameters

#### UEPTRANID

The address of the 4-byte transaction id.

#### UEPUSER

The address of the 8-byte userid associated with the transaction if the current task is a user task.

#### UEPTERM

The address of the 4-byte terminal id associated with the transaction, if any.

#### UEPPROG

The address of the 8-byte application program name for this transaction, if any.

#### UEPLSN

Address of a 26-character field containing the name of the log stream to be defined.

Your exit program should not modify the name of the logstream. On return from the exit, CICS ignores any changes to the contents of the field addressed by UEPLSN. JOURNALMODEL definitions are provided to cater for log stream name selection.

#### UEPMLSN

Address of a 26-character field specifying the name of the model log stream to be used to provide the attributes for the new log stream. This field is modifiable to allow the global user exit program to specify a different model log stream name from the one generated by CICS.

#### UEPIXG

Address of the IXGINVNT macro parameter list for use by the MVS system logger to define the log stream. Using the MF=M form of the IXGINVNT macro, the global user exit program can specify the log stream attributes to be used.

For details of the IXGINVNT macro, see the *OS/390 MVS Authorized Assembler Services* manual.

#### UEPLGTYP

Address of a 1-byte field indicating whether the log stream being created is for a system log or a general log. Valid values are:

### **UEPSYSLG**

The log stream is for a CICS system log.

### **UEPGENLG**

The log stream is for a general log (a forward recovery log, a user journal, or auto-journal).

### **Return codes**

#### **UERCNORM**

CICS continues and attempts to define the log stream.

#### **UERCBYB**

CICS does not attempt to define the log stream. The process that was attempting to use the log stream may fail (for example, a data set open).

### **XPI calls**

All can be used.

### **API and SPI commands**

Must not be used.

### **An example of how XLGSTRM can be used**

Imagine that you have 200 CICS regions, running on, say, 20 MVS images. To avoid having to define explicitly each log stream used by each CICS region, you decide to use model definitions. Log streams will be defined to MVS dynamically on their first usage, with an XLGSTRM exit program being used to select from alternative model log streams. This is how it might work:

1. On an initial start of a CICS region, the INITPARM system initialization parameter specifies:

```
INITPARM=(Exit_enabler_pgmname=nnn)
```

where:

- Exit\_enabler\_pgmname is the name of the program that enables the XLGSTRM user exit program.
  - nnn is a number that identifies a group of CICS regions that share the same set of log stream models.
2. The program that enables the XLGSTRM user exit program issues an EXEC CICS ASSIGN INITPARM command to retrieve the value nnn, and places it in the exit program's global work area.
  3. When the region tries to connect to its system log, because the log stream is not defined the XLGSTRM exit program is invoked. The exit program selects model CICS.DFHLOG.MODELnnn.

### **The sample program for the XLGSTRM exit, DFH\$LGLS**

The sample program, DFH\$LGLS, shows you how to access and change some of the parameters passed to an XLGSTRM exit program. Specifically, it:

- Changes the model log stream name pointed to by the UEPMLSN exit-specific parameter
- Uses the IXGINVNT macro to change the value of the HIGHOFFLOAD parameter in the log stream definition parameter list pointed to by the UEPIXG exit-specific parameter.

**Note:** To run the sample program “as is”, you must first create a model log stream called 'CICSAD01.DEPT0001.MODEL100'. However, you will probably want to tailor the sample to suit your own environment. The code contains comments to help you do this.

#### **Related concepts**

“The log manager domain sample exit program” on page 23

## **Message domain exit XMEOUT**

The XMEOUT exit allows you to suppress or reroute CICS and CICSplex SM messages that use the CICS message domain.

Your exit program is subject to certain restrictions:

- It cannot suppress or reroute messages sent to terminal operators, but only those sent to the system console or to transient data queues. (XMEOUT is not invoked for the former type of message.)
- It can suppress or reroute only messages that use the message domain. You can deduce which CICS messages this applies to from the *CICS Messages and Codes*: the description of each message that causes XMEOUT to be driven contains a list of XMEOUT parameters; if no XMEOUT parameters are listed for a message, the latter does not cause the exit to be driven. For example, message DFHDX8320 causes XMEOUT to be invoked, but message DFHDU0205 does not.

For CICSplex SM, XMEOUT is invoked only for messages that have a destination of EYULOG, as these are the messages that use the message domain. You can deduce which messages this applies to from *CICSplex System Manager Messages and Codes*.

**Note:** CICSplex SM messages that cause the XMEOUT exit to be driven, may be rerouted or suppressed only from the joblog or console, not from the EYULOG.

- It cannot reroute or suppress CICSplex SM Web User interface messages.
- It cannot change the text of a message, nor the message inserts. (If it tries to do so, CICS ignores the changes.)
- It cannot suppress or reroute messages issued during the early stages of CICS initialization (because the exit cannot be enabled then).
- It cannot reroute a message to transient data queues during CICS shutdown unless the original message destination included one or more transient data queues. If it attempts to do so, the message in question is routed to its original destination, and message DFHME0120I is issued to the console. Message DFHME0120I cannot be rerouted by the user exit program but it may be suppressed.

This restriction is necessary because the message domain is required to handle messages during CICS shutdown even after the transient data queue function has ended.

To discover whether CICS shutdown has started, your exit program can check for the first instance of message DFHME0120. It can stop rerouting messages to TD queues after DFHME0120 has been issued.

**Note:** If a message is being rerouted to a transient data queue and the transient data request fails, the message is lost. The MEME exception trace point ID X'0328' is written. The interpretation string of this trace entry provides an explanation of why the transient data request failed.

## Important

Because of the danger of recursion, your XMEOUT exit program should **not** try to reroute:

- Any DFHTDxxxx messages, produced by the transient data program.
- User domain messages in the range DFHUS0002 - DFHUS0006, plus message DFHUS0150.
- Transaction manager messages DFHXM0212, DFHXM0213, DFHXM0304 and DFHXM0308.
- Application messages DFHAP0001, DFHAP0002, DFHAP0004, DFHAP0601, DFHAP0602, and DFHAP0603.
- *Any* user domain (DFHUSxxxx) messages to an intrapartition queue defined with a TRIGLEV value of anything other than zero, if the messages are produced while the user domain is performing error recovery processing.

The message definition template contains an indicator called “noreroute”. This indicator is set on if the message being issued cannot be rerouted to a transient data queue by the XMEOUT exit program. The address of the indicator is passed to XMEOUT in the UEPNRTE exit-specific parameter. Your exit program can check the value of the indicator before deciding whether or not to reroute a particular message.

**Note:** If the exit program tries to reroute an ineligible message, the message domain inhibits the rerouting and issues the message to the console instead, along with message

DFHME0137

Each of the messages affected by this restriction is identified by a note in the *CICS Messages and Codes* manual.

It is possible to pass APPLID as an optional parameter in a message. However, the APPLID that is inserted in a message may not be the APPLID of the current CICS system. For example, when a CICSplex SM MAS message is routed to a CMAS, the APPLID of the MAS system may be passed, therefore the message will contain the APPLID of the MAS system and not the current system (the CMAS).

Your exit program can suppress or reroute messages by altering the values held in the addresses pointed to by the UEPMROU, UEPMNRC, UEPMTDQ, and UEPMNTD fields of the parameter list. These four sets of values (route codes, number of route codes, transient data queue names, and number of TDQs) are the only ones that your program can change.

## Exit XMEOUT

### When invoked

Before the message domain sends a CICS message to its destination.

### Exit-specific parameters

#### UEPTRANID

Address of the 4-byte transaction ID.

#### UEPUSER

Address of the 8-byte user ID.

**UEPTERM**

Address of the 4-byte ID of the terminal under which the current transaction is running. If the current transaction is not associated with a terminal, the addressed field contains hexadecimal zeroes.

**UEPPROG**

Address of the 8-byte application program name, or nulls if there is no current application.

**UEPMNUM**

Address of a 4-byte field containing the message number. For CICSplex SM messages, this field contains binary zeros.

**UEPMDOM**

Address of a 2-byte field containing the domain identifier of the CICS message. For CICSplex SM messages, this field contains binary zeros.

**UEPMROU**

Address of an array of up to 28 route codes. Route codes must be numbers in the range 1 through 28.

**UEPMNRC**

Address of a halfword containing the number of route codes in the route code array.

**UEPMTDQ**

Address of an array of up to 25 transient data queue names to which the message is to be sent. TD queue names must consist of 4 alphanumeric characters.

**UEPMNTD**

Address of a halfword containing the number of TDQs in the queues array.

**UEPINSN**

Address of a 2-byte field containing the number of message inserts.

**UEPINSA**

Address of an array, each element of which contains information about a single message insert. The size of the array depends on the number of inserts. Each array element has the following structure:

```

INSERT_FORMAT_P DS A Address of the 1-byte insert
                    type-code, which has one of
                    the following hexadecimal values:
                    0 Not present
                    1 Character
                    2 Hexadecimal
                    3 Decimal
                    4 The insert is a number
                      representing one item in
                      a list of options.
                      (See the example below.)
INSERT_P DS A Address of the message insert
INSERT_LENGTH_P DS A Address of a fullword contain-
                    ing the length of the insert
INSERT_TYPE_P DS A Reserved.
```

You can find the order of the inserts in the array from the entry for the particular message in the *CICS Messages and Codes* manual. For example,



DFHFC0531 *date time applid* Automatic journal *journal journalname*, opened for file *filename* is not of type MVS. Module *module*.

The XMEOUT inserts are *date*, *time*, *applid*, *journal*, *journalname*, *filename*, and *module*. The fourth insert (*journal*) is the number specified for JOURNAL on the file definition.

#### **UEPNRTE**

Address of 1-character flag indicating whether or not the message can be rerouted by XMEOUT. The possible values are:

**C'0:'** The message can be routed.

**C'1:'** The message cannot be routed.

#### **UEPCPID**

Address of a 3-byte product ID. The possible values are:

**DFH** CICS messages.

**EYU** CICSplex SM messages.

#### **UEPCPDOM**

Address of a 2-byte field containing the domain identifier of the message.

#### **UEPCPNUM**

Address of a 4-byte field containing the message number.

#### **UEPCPSEV**

Address of the message severity code.

### **Return codes**

#### **UERCNORM**

Continue processing.

#### **UERCBYP**

Suppress the message for all destinations.

Note that CICSplex SM messages cannot be suppressed. For these messages, a response of UERCBYP is treated as UERCNORM.

### **XPI calls**

WAIT\_MVS can be used. **Do not use any other calls.**

### **The sample XMEOUT global user exit programs**

CICS supplies the following sample programs, which show you how to use the XMEOUT exit to suppress or reroute messages:

#### **DFH\$XP1**

Suppress a message by message number

#### **DFH\$XP2**

Suppress a message by destination route code

#### **DFH\$XP3**

Suppress a message destined for the CSCS transient data queue (which receives signon and sign-off messages)

#### **DFH\$XP4**

Reroute a console message to a TDQ

**DFH\$SXP5**

Reroute a TDQ message to another TDQ

**DFH\$SXP6**

Reroute a TDQ message to a console.

**Related concepts**

“The message domain sample exit programs” on page 23

## Monitoring domain exit XMNOUT

XMNOUT is invoked at the following event points:

- Before an exception class monitoring record is passed to SMF
- Before a performance class monitoring record is written to the performance record buffer
- Before a transaction resource monitoring record is written to the transaction resource record buffer

**Note:** If performance class and transaction resource monitoring are both active in your CICS region, XMNOUT can be invoked twice for the same event. For example, if the event is end-of-task and CICS has both performance class data and transaction resource data to move to the appropriate buffer, XMNOUT is invoked once for each monitoring record type.

You can use this exit to examine the record, to suppress its output to SMF, or to change the data it contains. You must ensure that any changes you make do not conflict with the dictionary description of the data.

You can also add data to performance class data records. To do this you need to define dummy user event-monitoring points (EMPs) in the monitoring control table (MCT) to reserve data fields of the required size and type.

### Exit XMNOUT

**When invoked**

XMNOUT is invoked:

- Before an exception class monitoring record is written to SMF
- Before a performance class monitoring record is buffered for a later write to SMF
- Before a transaction resource monitoring record is buffered for a later write to SMF

**Exit-specific parameters****UEPTRANID**

Address of the 4-byte transaction ID. This field is not available at task termination.

**UEPUSER**

Address of the 8-byte user ID. This field is not available at task termination.

**UEPTERM**

Address of the 4-byte terminal ID. This field is not available at task termination.

**UEPPROG**

Address of the 8-byte application program name. This field is not available at task termination.

**UEPDICT**

Address of the dictionary. The sequence of dictionary entries is mapped by the DSECT generated from the macro DFHMCTDR. This field only has meaning for performance class records. If the monitoring record type is exception class (type 4) or transaction resource (type 5), this field is set to 0 (see parameter UEPMRTYP).

**UEPDICTE**

Address of the fullword number of dictionary entries. This field only has meaning for performance class records. If the monitoring record type is exception class (type 4) or transaction resource (type 5), this field is set to 0 (see parameter UEPMRTYP).

**UEPFCL**

Address of the field connector list, containing a series of halfword connector values. This field only has meaning for performance class records. If the monitoring record type is exception class (type 4) or transaction resource (type 5), this field is set to 0 (see parameter UEPMRTYP).

**UEPFCLNO**

Address of the fullword number of field connectors. This field only has meaning for performance class records. If the monitoring record type is exception class (type 4) or transaction resource (type 5), this field is set to 0 (see parameter UEPMRTYP).

**UEPMRTYP**

Address of the halfword monitoring record type. The monitoring record type value can be one of the numbers shown in the following table:

*Table 7.*

Record type value	Meaning
3	Performance class monitoring record
4	Exception class monitoring record
5	Transaction resource monitoring record

**UEPMRLEN**

Address of the fullword monitoring record length.

**UEPMREC**

Address of monitoring record, whose length is addressed by the parameter UEPMRLN.

**UEPSRCTK**

Address of the MVS workload manager service reporting class token for the current transaction. If CICS support for MVS workload management is not available, this token is null.

**UEMPREC**

Address of the monitoring performance record. This field has meaning only for performance class records. If the monitoring record type is exception class (type 4) or transaction resource (type 5), this field is set to 0 (see parameter UEPMRTYP). The performance record addressed by this parameter must be mapped using the DFHMNTDS dsect, and must not be mapped using the UEPDICT and UEPDICTE dictionary parameters.

**Return codes**

**UERCNORM**

Continue processing.

**UERCBYP**

Suppress monitor record output.

**UERCPURG**

Task purged during XPI call.

**XPI calls**

WAIT\_MVS can be used. **Do not use any other calls.**

## Pipeline domain exits

Use the pipeline domain exits to customize the processing that occurs for inbound and outbound Web services in the pipeline.

**Exit XWSPRROO**

Use the XWSPRROO exit to access containers on the current channel after the Web services provider application issues the Web service response message and before CICS creates the body of the response message.

You can use this exit to issue API and SPI commands to examine the containers on the current channel. You cannot issue a SOAP fault or update any of the containers. CICS ignores any return code specified in register 15 after the global user exit program has finished.

**Exit-specific parameters****UEPTRANID**

Address of the 4-byte transaction ID. The exit or task runs under this transaction ID.

**UEPUSER**

Address of the 8-byte user ID. The user ID is the one associated with the transaction ID.

**UEPTERM**

Address of the 4-byte terminal ID. The value is null for a Web service provider.

**UEPPROG**

Address of the 8-byte application program name. The application program name is that of the application handler DFHPITP.

**UEPCHANN**

Address of a 16-byte field that contains the name of the current channel. You can identify the channel explicitly using this parameter.

**UEPCONTR**

Address of a 16-byte field that contains the name of the data container on the channel named by UEPCHANN. This container holds the application data structure.

**UEPAPAB**

A 1-byte field indicating if the Web service provider application completed its processing successfully. Valid values are as follows:

**UEPAPABY (X'80')**

The Web service provider application abended.

| **UEPAPABN (X'40')**

| The Web service provider application completed its processing  
| successfully.

| **UEPAPSF**

| A 1-byte field indicating if the Web service provider application set a SOAP  
| fault. Valid values are as follows:

| **UEPAPSFY (X'80')**

| The Web service provider application is returning a SOAP fault.

| **UEPAPSFN (X'40')**

| The Web service provider application is not returning a SOAP fault.

| **Return codes**

| **UERCNORM**

| Continue processing.

| **API and SPI commands**

| The following commands are supported:

- | • EXEC CICS ABEND
- | • EXEC CICS ADDRESS
- | • EXEC CICS ASKTIME
- | • EXEC CICS ASSIGN
- | • EXEC CICS FORMATTIME
- | • EXEC CICS GET CONTAINER
- | • EXEC CICS HANDLE ABEND
- | • EXEC CICS INQUIRE WEBSERVICE
- | • EXEC CICS WRITE FILE
- | • EXEC CICS WRITEQ TD
- | • EXEC CICS WRITEQ TS

| **Related reference**

| “The pipeline sample exit program” on page 24

| The DFH\$PIEX sample global user exit program provides sample processing for the  
| XWSPRROO global user exit.

## **Program control program exits XPCREQ, XPCERES, XPCREQC, XPCFTCH, XPCHAIR, XPCTA, and XPCABND**

### **XPCREQ, XPCERES, and XPCREQC**

#### **XPCREQ**

XPCREQ is invoked by the EXEC interface program before a link request is processed. If the request is a distributed program link, the XPCREQ exit is driven on both sides of the link; that is, in both the client and the server regions. The exit program is passed the address of the application's parameter list (in UEPLPS), and can modify this as required. For example, you can use this exit to modify the SYSID at the time of a distributed program link request. One way you can achieve this is to write an application program to manage a list of SYSIDs in a global work area (GWA). The global user exit program can obtain access to the GWA, and use the information stored there to redirect DPL requests.

**Note:**

1. The attributes of the local PROGRAM definition are not passed to the exit program. If the exit program needs to know, for example, the value of the REMOTESYSTEM attribute, it can issue an **EXEC CICS INQUIRE PROGRAM** command.
2. If you use XPCREQ to change the target SYSID, remember that:
  - a. If SYSID specifies a remote region, no reference is made to the local PROGRAM resource definition. Thus, for example, in the remote region the program runs under the transid of the transaction in the client region, *not* under the TRANSID specified on the PROGRAM definition in the client region.
  - b. If SYSID specifies the local region, CICS treats the link request as if SYSID was not specified. The local PROGRAM definition is honored.
  - c. The XPCREQ exit is invoked by internal requests made by CICS code, as well as by requests made by applications.

**XPCERES**

XPCERES is invoked by the EXEC interface program before CICS processes either of the following kinds of dynamically-routed link request:

- A distributed program link (DPL) call
- A Link3270 bridge request

Note that XPCERES is invoked:

- After exit XPCREQ and before XPCREQC (if these exits are enabled). This means that:
  - If an XPCREQ exit program chooses to bypass the request, XPCERES is not invoked, even if it is enabled.
  - If an XPCREQ exit program modifies the command parameter list, XPCERES must deal with the modified request.
- On the *target* region—that is, the region to which the request has been routed.
- Only if the routing region—the region on which the routing program runs—supports the “resource unavailable” condition (RESUNAVAIL). To support the “resource unavailable” condition, the routing region must be a supported release of CICS.
- Only if it is enabled. It is strongly recommended that you enable this exit only in application-owning regions to which the above kinds of request may be dynamically routed.
- By internal requests made by CICS code, as well as by requests made by applications.

The XPCERES exit is *not* invoked:

- For statically-routed requests.
- If it is disabled.
- If an XPCREQ exit program chooses to bypass the request.

You can use XPCERES to check that all resources required by the linked-to program are available on the target region. If, for example, the program is disabled, or a required file is missing, your exit program can give the dynamic routing program the opportunity to route the request to a different region. To do this, set a return code of UERCRESU. This causes CICS to:

1. Set the DYRERROR field of the routing program's communications area to 'F'—resource unavailable.

2. Reinvoke the routing program, on the routing region, for route selection failure.
3. Return a RESUNAVAIL condition on the EXEC CICS LINK command executed by the mirror on the target region. (This condition is *not* returned to the application program.)

CICS ignores any changes made by the exit program to the values of any of the exit parameters. Your exit program can set a return code, but not change any parameters.

For guidance information about dynamically routing DPL requests, see the *CICS Intercommunication Guide*. For guidance information about dynamically routing Link3270 bridge requests, see the *CICS External Interfaces Guide*. For programming information about writing a dynamic routing program to route DPL requests, see “Routing DPL requests dynamically” on page 597. For programming information about writing a dynamic routing program to route Link3270 bridge requests, see “Routing bridge requests dynamically” on page 603.

### **XPCREQC**

XPCREQC is invoked after a link request has completed. You can use this exit to pass back a response to the application via the EIBRESP or EIBRESP2 fields. Such responses could be used to keep status information about a link request up-to-date. For example, if a link request fails because a connection is unavailable, XPCREQC could set EIBRESP=500 (a response code not used by CICS) to indicate the failure, enabling the application, in conjunction with the other exit, XPCREQ, to determine a suitable course of action.

**Note:** The XPCREQC exit is invoked by internal requests made by CICS code, as well as by requests made by applications.

### **Exit XPCREQ:**

#### **When invoked**

By the EXEC interface program before a link request is processed.

#### **Exit-specific parameters**

##### **UEPCLPS**

Address of the command parameter list.

##### **UEPPCTOK**

Address of a 4-byte token to be passed to XPCREQC. This allows you, for example, to pass a work area to exit XPCREQC.

##### **UEPRCODE**

Address of a 6-byte hexadecimal copy of EIBRCODE.

##### **UEPRECUR**

Address of a halfword recursion counter. The counter is set to 0 when the exit is first invoked, and is incremented for each recursive call.

##### **UEPRES P**

Address of a 4-byte copy of EIBRESP.

##### **UEPRES P2**

Address of a 4-byte copy of EIBRESP2.

##### **UEPTSTOK**

Address of a 4-byte token that is valid throughout the life of a task. See “Using the task token UEPTSTOK” on page 185.

**UEPRSRCE**

Address of an 8-character copy of the EIB resource value, EIBRSRCE.

**UEP\_PC\_PBTOK**

Address of a 4-byte field containing the z/OS Workload Manager (WLM) Performance Block Token. An exit program can use this token to access information (such as the service class token, SERVCLS) in the WLM Performance Block. To do so, it must use the WLM EXTRACT macro, IWMMEXTR, passing the Performance Block Token as the MONTKN input parameter. For more information about the IWMMEXTR macro, see *z/OS MVS Programming: Workload Management Services*.

An exit program must not attempt to modify the Performance Block: if it does so, the results are unpredictable.

**Return codes****UERCBYP**

Program control is to ignore the request.

**UERCNORM**

Continue processing.

**UERCPURG**

Task purged during XPI call.

**XPI calls**

All can be used.

Although the exit permits the use of XPI GETMAIN and FREEMAIN calls, we recommend that you use the EXEC CICS GETMAIN and FREEMAIN commands instead.

**API and SPI calls**

All can be used, except for:  
EXEC CICS SHUTDOWN  
EXEC CICS XCTL

**Exit XPCERES:****When invoked**

By the EXEC interface program, before processing of a program link or Link3270 bridge request that has been dynamically routed to this region, where the routing region supports the “resource unavailable” condition.

**Exit-specific parameters**

**Note:** CICS ignores any changes made by the exit program to the values of any of the exit parameters. Your exit program can set a return code, but not change any parameters.

**UEPCLPS**

Address of the command parameter list.

**UEPPCTOK**

Address of a 4-byte token to be passed to XPCREQC.

**UEPRCODE**

Address of a 6-byte hexadecimal copy of EIBRCODE.



**UEPRECUR**

Address of a halfword recursion counter. Because the XPCERES exit can never be called recursively in the same transaction, the value of this field is always 0.

**UEPRES**

Address of a 4-byte copy of EIBRESP.

**UEPRES2**

Address of a 4-byte copy of EIBRESP2.

**UEPTSTOK**

Address of a 4-byte token that is valid throughout the life of a task. See "Using the task token UEPTSTOK" on page 185.

**UEPRSRCE**

Address of an 8-character copy of the EIB resource value, EIBRSRCE.

**UEP\_PC\_PBTOK**

Address of a 4-byte field containing the z/OS Workload Manager (WLM) Performance Block Token. An exit program can use this token to access information (such as the service class token, SERVCLS) in the WLM Performance Block. To do so, it must use the WLM EXTRACT macro, IWMMEXTR, passing the Performance Block Token as the MONTKN input parameter. For more information about the IWMMEXTR macro, see *z/OS MVS Programming: Workload Management Services*.

An exit program must not attempt to modify the Performance Block: if it does so, the results are unpredictable.

**Return codes****UERCNORM**

Continue processing.

**UERCPURG**

Task purged during XPI call.

**UERCRESU**

A required resource is unavailable. Setting this value causes CICS to reject the routed request, and to return a value of 'F' (resource unavailable) in the DYRERROR field of the routing program's communications area.

**XPI calls**

All can be used.

Although the exit permits the use of XPI GETMAIN and FREEMAIN calls, we recommend that you use the EXEC CICS GETMAIN and FREEMAIN commands instead.

**API and SPI calls**

All except EXEC CICS SHUTDOWN and EXEC CICS XCTL can be used.

**Exit XPCREQC:****When invoked**

On completion of a program control link request.

**Exit-specific parameters**

**UEPCLPS**

Address of the command parameter list.

**UEPPCTOK**

Address of a 4-byte token passed from XPCREQ. This allows XPCREQ to, for example, pass a work area to XPCREQC.

**UEPRCODE**

Address of a 6-byte hexadecimal copy of EIBRCODE.

**UEPRECUR**

Address of a halfword recursion counter. The counter is set to 0 when the exit is first invoked, and is incremented for each recursive call.

**UEPRES**

Address of a 4-byte copy of EIBRESP.

**UEPRES2**

Address of a 4-byte copy of EIBRESP2.

**UEPTSTOK**

Address of a 4-byte token that is valid throughout the life of a task. See "Using the task token UEPTSTOK" on page 185.

**UEPRSRCE**

Address of an 8-character copy of the EIB resource value, EIBRSRCE.

**UEP\_PC\_REMOTE\_SYSTEM**

If the request is to be sent to a remote region, is the address of an area containing the 4-byte name of the remote region. (The remote region may have been specified by, for example, the SYSID option of the EXEC CICS LINK command, function shipping, work-load management, or the REMOTESYSTEM option of the PROGRAM definition.)

If the request is to be executed on the local region, this parameter is the address of a 4-byte area containing blanks.

**UEP\_PC\_REMOTE\_NAME**

If the program is to be executed in a remote system, is the address of an area containing the name of the program, as it is known in the remote system.

**UEP\_PC\_PBTOK**

Address of a 4-byte field containing the z/OS Workload Manager (WLM) Performance Block Token. An exit program can use this token to access information (such as the service class token, SERVCLS) in the WLM Performance Block. To do so, it must use the WLM EXTRACT macro, IWMMEXTR, passing the Performance Block Token as the MONTKN input parameter. For more information about the IWMMEXTR macro, see *z/OS MVS Programming: Workload Management Services*.

An exit program must not attempt to modify the Performance Block: if it does so, the results are unpredictable.

**Return codes****UERCNORM**

Continue processing.

## UERPURG

Task purged during XPI call.

### XPI calls

All can be used.

Although the exit permits the use of XPI GETMAIN and FREEMAIN calls, we recommend that you use the EXEC CICS GETMAIN and FREEMAIN commands instead.

### API and SPI calls

All can be used, except for:  
EXEC CICS SHUTDOWN  
EXEC CICS XCTL

**Note:** Take care when issuing recursive commands not to cause a loop. For example, it is your responsibility to avoid entering a loop when a program control request is issued from the XPCREQ or XPCREQC exits.

Use of the recursion counter UEPRECUR is recommended.

### *The command parameter structure:*

The command parameter structure consists of a series of addresses. The first address points to the EXEC interface descriptor (EID), which consists of a bit string that describes the type of request and identifies each keyword specified with the request. The remaining addresses point to pieces of data associated with the request; for instance, the second address always points to the program name. You can examine the parameters in the list to determine the values of the keywords. You can also modify values of parameters specified on the request. For example, you could change the name of the program involved in the request, or add the SYSID to route the link request to a remote system.

### **End of parameter list indicator**

The high-order bit is set on in the last address set in the parameter list to indicate that it is the last one in the list. On return from your user exit program, CICS scans the parameter list for the high-order bit to find the last parameter. Therefore, if you modify the length of the parameter list, you must also reset the high-order bit to indicate which is the new last address.

For example, if the parameter list specifies only the first two addresses (PC\_ADDR0, the address of the EID, and PC\_ADDR1, the address of the name of the program named in the link request), the high-order bit is set on in PC\_ADDR1. If you extend the parameter list by setting the address of a SYSID in PC\_ADDR7, you must unset the high-order bit in PC\_ADDR1 and set it on in PC\_ADDR7 instead.

The original parameter list, as it was before XPCREQ was invoked, is restored after the completion of XPCREQC. It follows that EDF will display the original command before **and** after execution: **EDF will not display any changes made by the exit.**

### *The UEPCLPS exit-specific parameter:*

The UEPCLPS exit-specific parameter is included in both exit XPCREQ and exit XPCREQC. It is the address of the command-level parameter structure. The command-level parameter structure contains 11 addresses, PC\_ADDR0 through

PC\_ADDRA. It is defined in the DSECT PC\_ADDR\_LIST, which you should copy into your exit program by including the statement COPY DFHPCED5.

The command-level parameter list is made up as follows:

**PC\_ADDR0**

is the address of a 7-byte area called the EXEC interface descriptor (EID), which is made up as follows:

- **PC\_GROUP**
- **PC\_FUNCT**
- **PC\_BITS1**
- **PC\_BITS2**
- **PC\_EIDOPT4**
- **PC\_EIDOPT5**
- **PC\_EIDOPT6**

**PC\_GROUP**

Always X'0E', indicating that this is a program control request.

**PC\_FUNCT**

One byte which defines the type of request, which for XPCREQ and XPCREQC is always X'02', indicating a LINK request.

**PC\_BITS1**

Existence bits that define which keywords that contain values were specified. To obtain the value associated with a keyword, you need to use the appropriate address from the command-level parameter list. Before using this address you must check the associated existence bit to ensure that the address is valid. If the existence bit is set off, the keyword was not specified in the request and the address should not be used. The symbolic and hexadecimal values of the existence bits are as follows:

**PC\_EXIST1 (X'80')**

Set if the request contains the keyword PROGRAM. If set, **PC\_ADDR1** is meaningful. (This bit should always be set for a LINK request.)

**PC\_EXIST2 (X'40')**

Set if the request specifies the COMMAREA parameter. If set, **PC\_ADDR2** is meaningful.

**PC\_EXIST3 (X'20')**

Set if the request specifies the LENGTH parameter. If set, **PC\_ADDR3** is meaningful.

**PC\_EXIST4 (X'10')**

Set if the request specifies the INPUTMSG parameter. If set, **PC\_ADDR4** is meaningful.

**PC\_EXIST5 (X'08')**

Set if the request specifies the INPUTMSGLEN parameter. If set, **PC\_ADDR5** is meaningful.

**PC\_EXIST6 (X'04')**

Set if the request specifies the DATALENGTH parameter. If set, **PC\_ADDR6** is meaningful.

**PC\_EXIST7 (X'02 ')**

Set if the request specifies the SYSID parameter. If set, PC\_ADDR7 is meaningful.

**PC\_EXIST8 (X'01 ')**

Set if the request specifies the TRANSID parameter. If set, PC\_ADDR8 is meaningful.

**PC\_BITS2**

One byte containing one of the following values:

**PC\_EXIST9 (X'80')**

Not used.

**PC\_EXISTA (X'40')**

Set if the request specifies the CHANNEL parameter. If set, PC\_ADDRA is meaningful.

**PC\_EIDOPT4**

Not used by program control.

**PC\_EIDOPT5**

Not used by program control.

**PC\_EIDOPT6**

Indicates whether the request specifies the SYNCONRETURN option. If it does, X'80' is set.

**PC\_ADDR1**

is the address of an 8-byte area containing the program name from the PROGRAM parameter.

**PC\_ADDR2**

is the address of the COMMAREA data.

**PC\_ADDR3**

is the address of a 2-byte area containing the length of the COMMAREA, as a half-word binary value.

**PC\_ADDR4**

is the address of the INPUTMSG data.

**PC\_ADDR5**

is the address of a 2-byte area containing the length of the INPUTMSG, as a half-word binary value.

**PC\_ADDR6**

is the address of a 2-byte area containing the length specified on the DATALENGTH parameter, defining how much data is to be sent from the COMMAREA. The length is held as a half-word binary value.

**PC\_ADDR7**

is the address of the 4-byte name of the remote system the LINK request is to be shipped to, as specified on the SYSID parameter.

**PC\_ADDR8**

is the address of the 4-byte name of the mirror transaction to be attached in the remote system, as specified on the TRANSID parameter.

**PC\_ADDR9**

is not used.

#### **PC\_ADDRA**

is the address of the 16-byte channel name, as specified on the CHANNEL parameter.

**Modifying fields in the command parameter structure:** Some fields that are passed to program control are used as input to the request, some are used as output fields, and some are used for both input and output. The method your user exit program uses to modify a field depends on the usage of the field.

*Modifying input fields:* The correct method of modifying an input field is to create a new copy of it, and to change the address in the command parameter list to point to your new data.

**Note:** You must never modify an input field by altering the data that is pointed to by the command parameter list. To do so would corrupt storage belonging to the application program and could cause a failure when the program attempted to reuse the field.

*Modifying output fields:* The technique described in “Modifying input fields” is not suitable for modifying output fields. (The results would be returned to the new area instead of the application’s area, and would be invisible to the application.)

An output field is modified by altering the data that is pointed to by the command-level parameter list. In the case of an output field you can modify the application’s data in place, because the application is expecting the field to be modified anyway.

**Modifying the EID:** It is not possible to modify the EID to make major changes to requests. It is not possible, for example, to change a LINK request to a different type of Program Control request.

However, you can make minor changes to requests, such as to turn on the existence bit for SYSID so that the request can be changed into one that is shipped to a remote system.

The list that follows shows the bits in the EID that can be modified. Any attempt to modify any other part of the EID is ignored.

#### **PC\_BITS1**

- X'40'** The existence bit for the COMMAREA
- X'20'** The existence bit for LENGTH
- X'10'** The existence bit for INPUTMSG
- X'08'** The existence bit for INPUTMSGLEN
- X'04'** The existence bit for DATALENGTH
- X'02'** The existence bit for SYSID
- X'01'** The existence bit for TRANSID.

#### **PC\_BITS2**

- X'40'** The existence bit for CHANNEL.

#### **PC\_EIDOPT5**

Not used for a PC link request.

Bits in the EID should be modified in place. You should not modify the pointer to the EID. (Any attempt to do so is ignored by CICS.)

The EID is reset to its original value before return to the application program. That is, changes made to the EID are retained for the duration of the program control request only.

Your user exit program is prevented from making major changes to the EID.

**Using the program control request token, UEPPCTOK:** UEPPCTOK provides the address of a 4-byte area that you can use to pass information between the XPCREQ and XPCREQC user exits for the same program control request. For example, the address of a piece of storage obtained by the XPCREQ user exit, which has to be freed by the XPCREQC user exit, can be passed in the UEPPCTOK field.

**Using the task token UEPTSTOK:** UEPTSTOK provides the address of a 4-byte area that you can use to pass information between successive program control requests in the same task. (By contrast, UEPPCTOK is usable only for the duration of a single program control request, because its contents may be destroyed at the end of the request.) For example, if you need to pass information between successive invocations of the XPCREQ exit, UEPTSTOK provides a means of doing this.

#### **The EIB:**

Copies of EIBRSRCE, EIBRCODE, EIBRESP, and EIBRESP2 are passed to the exit, so that you can:

- Modify or set completion or resource information in XPCREQ and XPCREQC.
- Examine completion information in XPCREQC.

You can update the copies of EIBRSRCE, EIBRCODE, EIBRESP and EIBRESP2 that you are given in the parameter list. Program Control copies your values into the real EIB after the completion of XPCREQC; or if you specify a return code of 'bypass' in XPCREQ.

You must set valid program control responses. You must set all three of EIBRCODE, EIBRESP and EIBRESP2 to a consistent set of values, such as would be set by Program Control to describe a valid completion. **Program Control does not police the consistency of EIBRCODE, EIBRESP, and EIBRESP2.** To aid you in setting the values of EIBRCODE, EIBRESP, and EIBRESP2, the values used by Program Control are specified in DFHPCEDS.

**Example of how XPCREQ and XPCREQC can be used:** XPCREQ and XPCREQC can be used for a variety of purposes. One example of a possible use is given below.

In this example, XPCREQ and XPCREQC are used to route LINK requests to a number of different CICS regions to provide a simple load balancing mechanism. The example shows only the capabilities of the exits; it is not intended to indicate an ideal way of achieving the load balancing function. For the purpose of this example, it is assumed that a global work area (GWA) already exists, and that it contains a list of available SYSIDs together with a count of the number of LINK requests currently being processed by each SYSID.

*In XPCREQ:*

1. Scan the global work area (GWA) to locate a suitable CICS region - for example, the region currently processing the least number of LINK requests.
2. Having decided which system to route the request to, increment the use count for this system.
3. Obtain a 4-byte area in which to store the SYSID for this request (this can be allocated from the GWA to avoid issuing a GETMAIN). If the area is obtained by issuing a GETMAIN, set UEPPCTOK to the address of the storage obtained.
4. Set PC\_ADDR7 to the address of the 4-byte area.
5. If setting PC\_ADDR7 now makes it the last address, set the high-order bit in the address, and unset the high-order bit in what was previously the last address.
6. Set the X'02' existence bit on in PC\_BITS1 to indicate that a SYSID is specified.
7. Return to CICS.

*In XPCREQC:*

1. Scan the global work area (GWA) and locate the entry for the CICS region specified in the SYSID parameter.
2. Decrement the use count for this system.
3. If a GETMAIN was issued in XPCREQ to obtain an area to hold the SYSID, issue a FREEMAIN for the address held in UEPPCTOK.
4. Return to CICS.

## **Exit XPCFTCH**

XPCFTCH is invoked before a PPT-defined program (including internal CICS modules) receives control, which could be because it is the first program in a transaction, or as a result of a LINK, XCTL, or HANDLE ABEND PROGRAM request. You can use this exit to modify the entry address used when linking to the program. If the exit sets a return code of zero, or a modified address of zero, the entry address of the original application program is used.

When XPCFTCH is invoked for a C or C++ program which was compiled with the XPLINK option, a flag is set to indicate that any modification of the entry point address that might be made by the user exit, is ignored.

The exit is intended to allow you to pass control to an *assembler* application program or routine *before the original program is invoked*. This assembler program, after it has finished its processing, should pass control back to the entry point of the original program using a branch instruction. You should not use the exit to cause a program to be invoked *instead of* the original program. If you do so, the results are unpredictable.

If a modified entry address is supplied, the program that is invoked receives control in the execution key that the original application program would have received control in—that is, as specified on the EXECKEY option of the original program's resource definition.

### **When invoked**

Before an application program receives control.

### **Exit-specific parameters**

#### **UEPPCDS**

Address of a storage area that contains program- and



terminal-related information, and that can be mapped using the DSECT DFHPCUE. When XPCFTCH is invoked, the following DFHPCUE fields are significant:

**PCUE\_CONTROL\_BITS**

- 1-byte flag field. A setting of PCUECBTE indicates that the transaction is linked to a terminal.
- A setting of PCUENOTX (X'40') indicates that the program is not command level.
- A flag, PCUE\_NO\_MODIFY, in PCUE\_CONTROL\_BITS indicates that a modified entry address is not supported. When set, any return code of UERCMEA from XPCFTCH is ignored. This flag is set by CICS before invoking XPCFTCH for C and C++ programs compiled with the XPLINK option.
- A setting of PCUE\_REAL (X'20') indicates that a real entry point is set in PCUE\_REAL\_ENTRY.

**PCUE\_TASK\_NUMBER**

3-character packed decimal field containing the task number.

**PCUE\_TRANSACTION\_ID**

4-character field containing the ID of the original transaction. Note that this may differ from the current transaction ID.

**PCUE\_TERMINAL\_ID**

4-character field containing the terminal ID (if any).

**PCUE\_PROGRAM\_NAME**

8-character field containing the name of the program that is to receive control.

**PCUE\_PROGRAM\_LANGUAGE**

3-character field containing the language of the program that is to receive control.

**PCUE\_LOAD\_POINT**

The program's load point.

**PCUE\_ENTRY\_POINT**

The program's entry point.

**PCUE\_PROGRAM\_SIZE**

Fullword containing the size of the program, in bytes.

**PCUE\_COMMAREA\_ADDRESS**

Address of the program's communication area, if the program has one.

**PCUE\_COMMAREA\_SIZE**

Fullword containing the length of the program's communication area, if the program has one.

**PCUE\_LOGICAL\_LEVEL**

Fullword containing the number of chained DFHRSADS blocks (that is, logical level).

**PCUE\_BRANCH\_ADDRESS**

Fullword. Use this field to supply an alternative entry

address. Set the top bit to specify that the alternative program is to run AMODE (31).

#### **PCUE\_REAL\_ENTRY**

From z/OS 1.7 onwards, this field provides the real entry point for Language Environment conforming programs. Previously only PCUE\_ENTRY\_POINT was available to you, but for Language Environment conforming programs this did not contain the entry point that you needed to know about.

**Note:** With z/OS 1.7, this field provides a solution to the problem raised by APAR PQ43992.

#### **PCUE\_CHANNEL\_NAME**

Address of a 16-byte field containing the name of the channel with which the application program is to be invoked (that is, the program's current channel). If there is no channel, this field is set to blanks.

#### **Return codes**

##### **UERCNORM**

Continue processing.

##### **UERCPURG**

Task purged during XPI call.

##### **UERCMEA**

Entry address has been modified.

#### **XPI calls**

All can be used.

#### **The sample XPCFTCH global user exit program, DFH\$PCEX**

Note that there is a CICS-supplied sample exit program, DFH\$PCEX, that is designed to be driven by the XPCFTCH exit. For more information about DFH\$PCEX, see "Sample global user exit programs" on page 15.

#### **Exit XPCHAIR**

XPCHAIR is invoked before a HANDLE ABEND LABEL routine is given control. Note that this occurs only when a program abend causes a branch to an internal abend routine. (When the HANDLE ABEND request specifies PROGRAM, exit XPCFTCH is invoked, as described above.) You can use this exit to supply an alternative handle-abend address. If the exit sets a return code of zero, or an alternative address of zero, CICS passes control to the application program's specified internal routine.

If a modified entry address is supplied:

- The code that is invoked receives control in the execution key that the internal abend routine would have received control in—that is, the key in force when the EXEC CICS HANDLE ABEND LABEL command was issued.
- The resume address is placed in either register 14 or register 15, depending on the language of the application. For COBOL, R14 holds the return address; for Assembler, R15 is used. If you run in a mixed environment, your exit program may need to set up its own base register. For example, you could set up addressability using:

BASSM 15,0  
USING \*,15

### When invoked

Before a HANDLE ABEND routine is given control.

### Exit-specific parameters

#### UEPPCDS

Address of a storage area that contains program- and terminal-related information, and that can be mapped using the DSECT DFHPCUE. When XPCHAIR is invoked, the following DFHPCUE fields are significant:

#### PCUE\_CONTROL\_BITS

1-byte flag field. A setting of PCUECBTE indicates that the transaction is linked to a terminal.

#### PCUE\_TASK\_NUMBER

3-character packed decimal field containing the task number.

#### PCUE\_TRANSACTION\_ID

4-character field containing the transaction ID.

#### PCUE\_TERMINAL\_ID

4-character field containing the terminal ID (if any).

#### PCUE\_PROGRAM\_NAME

8-character field containing the name of the program that issued the HANDLE ABEND LABEL command.

#### PCUE\_LOGICAL\_LEVEL

Fullword containing the number of chained DFHRSADS blocks (that is, logical level).

#### PCUE\_BRANCH\_ADDRESS

Fullword. Use this field to supply the address of an alternate abend routine. Set the top bit to specify that the alternate abend routine is to run AMODE (31).

#### UEPTACB

Address of the transaction abend control block (TACB) for the abend. If the abend occurred because of a program check, the information in the TACB includes:

- The program status word (PSW)
- The registers at the time of the abend
- Details of the subspace and access registers current at the time of the abend.

You can map the TACB using the DFHTACB TYPE=DSECT macro.

### Return codes

#### UERCNORM

Continue processing.

#### UERCPURG

Task purged during XPI call.

#### UERCMEA

The address of an alternate abend routine has been supplied.

## XPI calls

All can be used.

## Exit XPCTA

XPCTA is invoked immediately after a transaction abend, and before any processing that might modify the existing environment so that the task could not be resumed. You can use it to:

- Set a resume address, instead of letting CICS process the abend
- Specify the subspace that control is passed in.

If a resume address is passed back, registers 0 through 13 and 15 are restored to their values at the time of the abend. Register 14 is used to branch to the resume address. If the exit sets a return code of zero, or a resume address of zero, CICS processes the abend.

**Note:** If the transaction abend occurs as a result of a program check or an operating system abend:

1. It is possible that the XDUREQ dump domain exit may be invoked before XPCTA. (For details of XDUREQ, see page “Exit XDUREQ” on page 53.)
2. If a resume address is passed back, registers 0 through 15 are restored to their value at the time of the abend. The PSW is used to branch to the resume address.

A resume address, normally obtained from the return code UERCMEA from XPCTA, is ignored for C and C++ programs compiled with the XPLINK option.

### When invoked

After an abend and before the environment is modified.

### Exit-specific parameters

#### UEPPCDS

Address of a storage area that contains program- and terminal-related information, and that can be mapped using the DSECT DFHPCUE. When XPCTA is invoked, the following DFHPCUE fields are significant:

#### PCUE\_CONTROL\_BITS

1-byte flag field. A setting of PCUECBTE indicates that the transaction is linked to a terminal.

A flag, PCUE\_NO\_RESUME, in PCUE\_CONTROL\_BITS indicates that a resume address is not supported. When set, any return code of UERCMEA from XPCTA is ignored. This flag is set by CICS before invoking XPCTA for C and C++ programs compiled with the XPLINK option.

#### PCUE\_TASK\_NUMBER

3-character packed decimal field containing the task number.

#### PCUE\_TRANSACTION\_ID

4-character field containing the transaction ID.

#### PCUE\_TERMINAL\_ID

4-character field containing the terminal ID (if any).

#### PCUE\_PROGRAM\_NAME

8-character field containing the name of the failing program.

**PCUE\_LOGICAL\_LEVEL**

Fullword containing the number of chained DFHRSADS blocks (that is, logical level).

**PCUE\_BRANCH\_ADDRESS**

Fullword. You can use this field to supply a resume address. Set the top bit to specify that the resumed task is to run AMODE (31).

**PCUE\_BRANCH\_EXECKEY**

If storage protection is active, you can use this 1-byte field to specify the execution key of the resumed task. The possible values are:

**PCUE\_BRANCH\_USER**

User key

**PCUE\_BRANCH\_CICS**

CICS key.

If storage protection is active, and you do not specify a value, the resumed task executes in User key.

If storage protection is not active, the resumed task executes in CICS key.

**UEPTACB**

Address of the transaction abend control block (TACB) for the abend. If the abend occurred because of a program check, the information in the TACB includes:

- The program status word (PSW)
- The registers at the time of the abend
- The execution key at the time of the abend
- Details of the subspace and access registers current at the time of the abend.

You can map the TACB using the DFHTACB TYPE=DSECT macro.

**Return codes****UERCNORM**

Continue processing.

**UERCPURG**

Task purged during XPI call.

**UERCMEA**

A resume address has been supplied.

**XPI calls**

All can be used.

**The sample XPCTA global user exit program, DFH\$PCTA**

The sample program tests whether the abend was caused by the application program trying to overwrite CICS-key storage in the CDSA or ECDSA, while running in user key. If this was the case, the sample changes the execution key to CICS, and retries the failing instruction.

You can use the sample program to identify, without abending, those programs that need to be defined with EXECKEY(CICS), because they intentionally modify a CICS-key DSA. For details of how to do this, see the prolog of DFH\$PCTA.

DFH\$PCTA can be extended for transaction isolation.

### **Related concepts**

“The transaction-abend sample exit program” on page 24

## **Exit XPCABND**

XPCABND is invoked after a transaction abend and before a transaction dump call: you can use it to suppress the dump.

### **When invoked**

After a transaction abend and before a transaction dump call is made.

### **Exit-specific parameters**

#### **UEPPCDS**

Address of a storage area that contains program-related and terminal-related information. The storage area is mapped by the DSECT DFHPCUE.

When XPCABND is invoked, the following DFHPCUE fields are significant:

#### **PCUE\_CONTROL\_BITS**

A 1-byte flag field. A setting of PCUECBTE indicates that the transaction is linked to a terminal.

#### **PCUE\_TASK\_NUMBER**

A 3-character packed decimal field containing the task number.

#### **PCUE\_TRANSACTION\_ID**

A 4-character field containing the transaction ID.

#### **PCUE\_TERMINAL\_ID**

A 4-character field containing the terminal ID (if any).

#### **PCUE\_PROGRAM\_NAME**

An 8-character field containing the name of the program that is abending.

#### **PCUE\_LOGICAL\_LEVEL**

A fullword containing the number of chained DFHRSADS blocks (that is, the logical level).

#### **UEPTACB**

Address of the transaction abend control block (TACB) for the abend. If the abend occurred because of a program check, the information in the TACB includes:

- The program status word (PSW)
- The registers at the time of the abend.
- Details of the subspace and access registers current at the time of the abend.

You can map the TACB using the DFHTACB TYPE=DSECT macro.

### **Return codes**

#### **UERCNORM**

Continue processing – make the dump call.

**UERCBYP**

Suppress the dump call.

**UERCPUrg**

Task purged during XPI call.

**XPI calls**

All can be used.

## Resource manager interface program exits XRMIIN and XRMIOU

### Exit XRMIIN

**When invoked**

Before a task-related user exit program is invoked due to an application program issuing an RMI API request.

**Exit-specific parameters****UEPTRUEN**

Address of the name of the task-related user exit program.

**UEPTRUEP**

Address of the parameter list to be passed to the task-related user exit program.

**UEP\_RM\_PBTOK**

Address of a 4-byte field containing the z/OS Workload Manager (WLM) Performance Block Token. An exit program can use this token to access information (such as the service class token, SERVCLS) in the WLM Performance Block. To do so, it must use the WLM EXTRACT macro, IWMMEXTR, passing the Performance Block Token as the MONTKN input parameter. For more information about the IWMMEXTR macro, see *z/OS MVS Programming: Workload Management Services*.

An exit program must not attempt to modify the Performance Block: if it does so, the results are unpredictable.

**UEPRECUR**

Address of a halfword recursion counter. The counter is set to 0 when the exit is first invoked, and is incremented for each recursive call.

**Note:** The task-related user exit program's parameter list is mapped by a DFHUEPAR DSECT that shares common field names with the global user exit program's DFHUEPAR parameter list. To include both DSECT definitions in your exit program, you must code:

```
DFHUEXIT TYPE=EP, ID=XRMIIN
DFHUEXIT TYPE, TYPE=RM
```

The statements must be coded in this order.

The two DFHUEPAR parameter lists, the global user exit's and the task-related user exit's, occupy separate areas of storage. The task-related user exit's parameter list is provided for information only; you should not amend it in any way.

**Return codes**

## **UERCNORM**

Continue processing.

## **UERCPURG**

Task purged during XPI call.

### **XPI calls**

All can be used.

### **API and SPI commands**

All except EXEC CICS SHUTDOWN and EXEC CICS XCTL can be used. However, CALLDLI, EXEC DLI, or EXEC SQL commands must **not** be used.

## **Exit XRMIOU**

### **When invoked**

After a task-related user exit program has returned from handling an RMI API request.

### **Exit-specific parameters**

#### **UEPTRUEN**

Address of the name of the task-related user exit program.

#### **UEPTRUEP**

Address of the parameter list to be passed to the task-related user exit program.

#### **UEP\_RM\_PBTOK**

Address of a 4-byte field containing the z/OS Workload Manager (WLM) Performance Block Token. An exit program can use this token to access information (such as the service class token, SERVCLS) in the WLM Performance Block. To do so, it must use the WLM EXTRACT macro, IWMMEXTR, passing the Performance Block Token as the MONTKN input parameter. For more information about the IWMMEXTR macro, see *z/OS MVS Programming: Workload Management Services*.

An exit program must not attempt to modify the Performance Block: if it does so, the results are unpredictable.

#### **UEPRECUR**

Address of a halfword recursion counter. The counter is set to 0 when the exit is first invoked, and is incremented for each recursive call.

**Note:** The task-related user exit program's parameter list is mapped by a DFHUEPAR DSECT that shares common field names with the global user exit program's DFHUEPAR parameter list. To include both DSECT definitions in your exit program, you must code:

```
DFHUEXIT TYPE=EP, ID=XRMIOU  
DFHUEXIT TYPE, TYPE=RM
```

The statements must be coded in this order.

The two DFHUEPAR parameter lists, the global user exit's and the task-related user exit's, occupy separate areas of storage. The task-related user exit's parameter list is provided for information only; you should not amend it in any way.



## Return codes

### UERCNORM

Continue processing.

### UERPURG

Task purged during XPI call.

## XPI calls

All can be used.

## API and SPI commands

All except EXEC CICS SHUTDOWN and EXEC CICS XCTL can be used. However, CALLDLI, EXEC DLI, or EXEC SQL commands must **not** be used.

**Note:** It is not recommended that your exit program make calls to other external resource managers that use the RMI, because this causes recursion, and may result in a loop. It is your exit program's responsibility to avoid entering a loop. It could use the recursion counter field UEPRECUR to guard against this.

## Resource management install and discard exit XRSINDI

The XRSINDI global user exit is driven, if it is enabled, immediately after CICS successfully installs or discards a resource definition.

The install and discard activities that drive the exit are as follows:

- The install function of the group list on an initial or cold start of CICS
- The CEDA INSTALL command
- The CICSplex SM BAS INSTALL command
- All autoinstall operations, as follows:
  - The autoinstall of a terminal, connection, program, mapset, partitionset, or journal
  - The automatic discard of an unused terminal, controlled by the AILDELAY system initialization parameter and the SIGNOFF parameter on the TYPETERM resource definition.
- The connection to, and disconnection from, an MVS log stream
- A CEMT DISCARD and EXEC CICS DISCARD command
- A EXEC CICS CREATE command
- The front-end programming interface (FEPI) install and discard operations: the EXEC CICS FEPI INSTALL command and EXEC CICS FEPI DISCARD command.

The parameter list is designed to pass the names of more than one resource installed or discarded, in field UEPIDNAM. When designing your global user exit program, do not assume that the number of resource names passed is always one. You are recommended to analyze the resources within a loop based on the value referenced by UEPIDNUM.

Note that the names of modegroups are prefixed with the corresponding connection name. There is no separator between the two names: the first four characters form the connection name, followed by eight characters for the modegroup. The parts of the concatenated name are fixed length—if connection names are defined with less than four characters, they are padded with blanks in the concatenated names. Similarly, the connection names for a front-end programming interface (FEPI)

connection is a concatenation of a FEPI node name and a FEPI target name, each of which is 8 characters long (fixed length) with no separator.

The exit is driven once for each individual resource in a group list installed during a CICS initial or cold start. If you are concerned about the performance overhead on an initial or cold start, do not enable the exit until after the group list is installed. To obtain the information about resources installed prior to enabling the exit, you can write a program to scan the tables of installed resources, using the EXEC CICS INQUIRE *resource\_name* browse function.

## Exit XRSINDI

### When invoked

Whenever CICS installs or discards a resource definition.

### Exit-specific parameters

#### UEPTRANID

Address of the 4-byte transaction ID.

#### UEPUSER

Address of the 8-byte user ID.

#### UEPTERM

Address of the 4-byte terminal ID.

#### UEPPROG

Address of the 8-byte application program name.

#### UEPIDREQ

Address of the 1-byte install or discard identifier. The values are:

#### UEIDINS

This request is for an install (or in the case of a log stream, it is a connection to a log stream).

#### UEIDDIS

This request is for a discard (or in the case of a log stream, it is a disconnection from a log stream).

#### UEPIDTYP

Address of the 1-byte type of resource. The values are:

#### UEIDAITM

An autoinstall terminal model

#### UEIDBEAN

An enterprise bean.

**Note:** XRSINDI is called once for each bean in a deployed JAR file. For install, these calls occur after the call for the install of the DJAR. For discard, they occur before the call for the discard of the DJAR.

#### UEIDCONN

A connection

#### UEIDCSRVR

A CorbaServer execution environment for enterprise beans and CORBA stateless objects (CORBASERVER)

#### UEIDDB2C

A DB2 connection

**UEIDDB2E**  
A DB2 entry (DB2ENTRY)

**UEIDDB2T**  
A DB2 transaction (DB2TRAN)

**UEIDDJAR**  
A deployed JAR file (DJAR)

**UEIDDOCT**  
A DOCTEMPLATE

**UEIDFECO**  
A FEPI connection

**UEIDFENO**  
A FEPI node

**UEIDFEPO**  
A FEPI pool

**UEIDFEPS**  
A FEPI propertyset

**UEIDFETA**  
A FEPI target

**UEIDFILE**  
A file

**UEIDIPCO**  
An IPIC connection ( "IPCONN")

**UEIDJNMD**  
A journal model

**UEIDJNNM**  
A journal name

**UEIDLBRY**  
A LIBRARY resource

**UEIDMAP**  
A mapset

**UEIDMODE**  
A modegroup

**UEIDNQRN**  
An ENQMODEL

**UEIDPART**  
A partner

**UEIDPIPE**  
A pipeline (PIPELINE)

**UEIDPROF**  
A profile

**UEIDPROG**  
A program

**UEIDPRTY**  
A BTS process-type

**UEIDPSET**

A partitionset

**UEIDRQMD**

A request model (IIOF)

**UEIDSESS**

A session

**UEIDSTRM**

An MVS log stream

**UEIDTCLS**

A transaction class

**UEIDTCPS**

A TCP/IP service

**UEIDTDQU**

A transient data queue

**UEIDTERM**

A terminal

**UEIDTRAN**

A transaction

**UEIDTSMD**

A temporary storage queue model.

**UEIDURIM**

A URI map (URIMAP)

**UEIDWEBS**

A Web service (WEBSERVICE)

**UEPIDLEN**

Address of the length of an individual resource name, as a full-word binary value.

**UEPIDNUM**

Address of the number of resources reported by this call, as a full-word binary value.

**UEPIDNAM**

Address of a variable-length list containing the names of the individual resources reported by this call.

**UEPIDREC**

Address of a 1-byte identifier indicating whether resources are recovered at a warm or emergency restart. The values are:

**UEIDKEEP**

The resources are recoverable at a warm or emergency restart.

**UEIDLOSE**

The resources are not recoverable.

**Note:** The exit is not driven during a CICS restart.

**Return codes****UERCNORM**

Continue processing. This is the default.

## **UERCPURG**

Task purged during XPI call.

### **XPI calls**

You can use all XPI calls.

### **Important**

Abends in a program enabled at the XRSINDI exit point may cause CICS to terminate, because for some resources the exit is driven during syncpoint. If the exit returns code UERCPURG during syncpoint for these resources, abend code AUPEP is produced and CICS terminates.

## **Signon and signoff exits XSNON, XSNOFF, and XSNEX**

Exit XSNON is invoked after a terminal user signs on, and exit XSNOFF is invoked after a terminal user signs off (whether the signon or sign-off is successful or not). XSNON and XSNOFF do not make any security decisions; they are merely a means of tracking users logging on and off a CICS system.

The activities which drive the exits are:

- Invocation of an EXEC CICS SIGNON command for a terminal (when, for example, the terminal user enters the CICS-supplied CESN, or an equivalent, user-written, signon transaction)
- Invocation of an EXEC CICS SIGNON command for a surrogate terminal (that is, a terminal attached by the CRTE routing transaction, or by dynamic transaction routing)
- Invocation of an EXEC CICS SIGNOFF command for a terminal
- When a 'CANCEL' command is entered to terminate a CRTE routing session
- A timeout sign-off.

XSNEX is a special-purpose global user point, which is intended to be used only with the IBM-supplied global user exit program, DFH\$SNEX.

### **Exit XSNON**

#### **When invoked**

When a user signs on.

#### **Exit-specific parameters**

##### **UEPUSRID**

Address of the terminal userid.

##### **UEPUSRLN**

Address of the terminal userid length.

##### **UEPGRPID**

Address of the group ID. If the signon was successful, the group ID is that which the user is associated with in this signon session. If the signon was unsuccessful, it is that specified by the user when he or she tried to sign on.

##### **UEPGRPLN**

Address of the group ID length.

##### **UEPNETN**

Address of the terminal's netname.

**UEPTRMID**

Address of the terminal id.

**UEPTCTUA**

Address of the TCT user area.

**UEPTCTUL**

Address of the TCT user area length.

**UEPTRMTY**

Address of the terminal-type byte.

**UEPSNFLG**

Address of a 2-byte field containing flags:

*Table 8. Flags set in the UEPSNFLG field of XSNON*

Flag	Equivalent	Meaning
UEPSNOK	0	Signon was successful.
UEPSNFL	1	Signon failed.
UEPSNPSS	2	The persistent sessions signon succeeded.
UEPSNPSF	3	The persistent sessions signon failed.

**Return codes****UERCNORM**

Continue processing.

**UERCPURG**

Task purged during XPI call.

**XPI calls**

All can be used.

**Exit XSNOFF****When invoked**

When a user signs off.

**Exit-specific parameters****UEPUSRID**

Address of the terminal userid.

**UEPUSRLN**

Address of the terminal userid length.

**UEPGRPID**

Address of the group ID.

**UEPGRPLN**

Address of the group ID length.

**UEPNETN**

Address of the terminal's netname.

**UEPTRMID**

Address of the terminal id.

**UEPTCTUA**

Address of the TCT user area.

**UEPTCTUL**

Address of the TCT user area length.

**UEPTRMTY**

Address of the terminal-type byte.

**UEPSNFLG**

Address of a 2-byte field containing flags:

**UEPSNOK**

Sign-off was successful

**UEPSNFL**

Sign-off failed

**UEPSNML**

Normal sign-off

**UEPSNTIM**

Timeout sign-off.

**Return codes****UERCNORM**

Continue processing.

**UERCPURG**

Task purged during XPI call.

**XPI calls**

All can be used.

**Exit XSSEX**

The purpose of XSSEX, in conjunction with its supporting sample programs, is to provide a short-term migration aid. It is designed to give you time to modify those application programs that have a dependency on the way CICS handles EXEC CICS SIGNON and SIGNOFF before CICS TS 2.1, to enable them to work with the current behavior.

**Note: XSSEX is a migration aid only.** You should consider removing all application dependency on the old sign-on and sign-off behaviour.

There are no exit-specific parameters for this global user exit, which is invoked whenever an application program issues an EXEC CICS SIGNON or an EXEC CICS SIGNOFF command. You are not intended to write your own global user exit program for this exit point. IBM provides DFH\$SSEX, the sole purpose of which is to make CICS handle EXEC CICS SIGNON and SIGNOFF commands in the same way as in CICS TS 1.3 and earlier.

The supplied programs are:

**DFH\$SSEX**

This user exit program is supplied in SDFHSAMP. The only function the program performs is to set return code UERCPREV, which causes the security domain to restore CICS behavior as in CICS TS 1.3 and earlier. You can enable this user exit program using DFH\$SNPI.

**DFH\$SNPI**

This post-initialization program is supplied in SDFHSAMP. It issues an EXEC CICS ENABLE PROGRAM('DFH\$SSEX') EXIT('XSSEX') command to enable the IBM-supplied user exit program, DFH\$SSEX, in the final stages of CICS initialization.

To use this program, add an entry to the first section of your PLTPI table (that is, before the DFHDELIM statement). For example:

```
DFHPLT TYPE=INITIAL,SUFFIX=SN
DFHPLT TYPE=ENTRY,PROGRAM=DFH$SNPI
DFHPLT TYPE=ENTRY,PROGRAM=DFHDELIM
DFHPLT TYPE=FINAL
END
```

## Statistics domain exit XSTOUT

On invocation, XSTOUT is passed the address of a buffer containing one or more statistics records. The buffer can contain records for various resource types (for example, connections and modenames), and both specific and global information (for example, loader statistics for individual programs, and loader statistics for all programs).

Your exit program can identify the types of records in the buffer by their STID values. (STID values are described in “CICS statistics data section” on page 773.)

You can use XSTOUT to prevent the contents of the statistics data buffer being written to SMF. Note that you cannot use it to selectively suppress individual records within the buffer. Your exit program should not modify the values of any of the exit-specific parameters.

**Note:** Some statistics records may be produced during very early during CICS initialization which will not be passed to XSTOUT. The earliest that a global user exit can be enabled is during PLT processing. Before this no exits can be invoked.

### Exit XSTOUT

#### When invoked

Before a statistics record is written to SMF.

#### Exit-specific parameters

Fields UEPTRANID, UEPUSER, UEPTERM, and UEPPROG have meaning **only** for requested statistics (when using CEMT PERFORM STATISTICS RECORD or the EXEC CICS PERFORM STATISTICS RECORD command).

#### UEPTRANID

Address of the 4-byte transaction ID.

#### UEPUSER

Address of the 8-byte user ID.

#### UEPTERM

Address of the 4-byte terminal ID.

#### UEPPROG

Address of the 8-byte application program name.

#### UEPSTATS

Address of a buffer containing one or more statistics records. For unsolicited statistics, the buffer always contains one record; for other types of statistics, it may contain several records. The length of the buffer is addressed by the UEPSRLLEN parameter.

#### UEPSRLLEN

Address of the 4-byte hexadecimal length of the statistics record.



**UEPSTYPE**

Address of the 3-byte character field statistics type. The values of the types are:

- INT** Interval statistics
- EOD** End-of-day statistics
- REQ** Requested statistics
- RRT** Requested reset statistics
- USS** Unsolicited statistics.

**UEPSDATE**

Address of a 6-byte character field containing the collection date (MMDDYY).

**UEPSTIME**

Address of a 6-byte character field containing the collection time (HHMMSS).

**UEPSIVAL**

Address of a 6-byte character field containing the interval time (HHMMSS). This field has meaning only for interval statistics.

**UEPSIVN**

Address of the 4-byte interval number. This field has meaning only for interval statistics.

**UEPSCLD**

Address of an 8-byte character field containing the collection date (MMDDYYYY).

**Return codes****UERCNORM**

Continue processing.

**UERCBYP**

Suppress output of statistics data buffer to SMF.

**XPI calls**

WAIT\_MVS can be used. **Note, however, that the wait cannot be purged using CEMT or SPI. Do not use any other calls.**

## System recovery program exit XSRAB

**When invoked**

When the system recovery program (DFHSRP) finds a match in the SRT for an MVS abend code. For information about defining entries in the SRT, refer to the *CICS Resource Definition Guide*.

The SRT table is only processed, and the exit driven, when an MVS abend occurs under a CICS essential TCB; that is, one of QR, RO, CO, SZ, RP, FO. For nonessential TCB types, such as L8, J8, J9, JM, SL, SO, or S8, the exit is not driven.

**Exit-specific parameters****UEPERROR**

Address of the error data structure, SRP\_ERROR\_DATA, which contains the following fields:

**SRP\_ERROR\_TYPE**

The 4-character error type—always 'ASRB'.

**SRP\_SYS\_ABCODE**

2 bytes containing the system abend code XXX in binary format (for example, D37).

**SRP\_USER\_ABCODE**

2 bytes containing the user abend code NNNN in binary format (for example, 0999).

**SRP\_ERROR\_TRANID**

4-character field containing the ID of the abending transaction.

**SRP\_ERROR\_STACK\_NAME**

8-character field containing the name of the current kernel stack entry for the transaction at the time of the abend.

**SRP\_ERROR\_PPT\_NAME**

8-character field containing the name of the current PPT entry for the transaction, if one exists. This field contains a value only if flag SRP\_PPT\_ENTRY is set.

**SRP\_ERROR\_OFFSET**

Fullword containing the offset into the program that abended, as follows:

- If flag SRP\_PPT\_ENTRY is set, gives the offset in SRP\_ERROR\_PPT\_NAME
- Otherwise, gives the offset in SRP\_ERROR\_STACK\_NAME.

This field contains a value only if flag SRP\_VALID\_OFFSET is set.

**SRP\_ERROR\_FLAGS**

1 byte containing flags:

**SRP\_CICS\_CODE**

The abend occurred while running CICS code.

**SRP\_USER\_CODE**

The abend occurred while running user application code.

**SRP\_PPT\_ENTRY**

The abend occurred while running SRP\_ERROR\_PPT\_NAME. If this flag is not set, the abend occurred while running SRP\_ERROR\_STACK\_NAME.

**SRP\_VALID\_OFFSET**

A meaningful offset could be determined.

**SRP\_VALID\_REASON**

MVS has supplied a reason code for the abend.

**SRP\_NOT\_CICS\_RB**

CICS RB was not in control at the time of the abend (that is, the abend occurred in a system service invoked by CICS).

**SRP\_CICS\_ERROR\_REASON**

4-character field containing the MVS abend reason code. It contains a value only if flag SRP\_VALID\_REASON is set.

**SRP\_CICS\_ERROR\_DATA**

An area describing the last thing that CICS did, prior to the abend. It contains the following:

**SRP\_CICS\_EC\_PSW**

8-character field containing the extended control (EC) mode program status word (PSW)

**SRP\_CICS\_EC\_INT**

8-character field containing the interrupt code and ILC

**SRP\_CICS\_REGST**

64-character field containing the contents of the general-purpose (GP) registers

**SRP\_CICS\_EXEC\_KEY**

1 byte containing the PSW key, in the form X'0n'.

**SRP\_SYSTEM\_ERROR\_DATA**

An area describing the last thing “the system” did, prior to the abend. It contains the following:

**SRP\_SYSTEM\_EC\_PSW**

8-character field containing the EC mode PSW

**SRP\_SYSTEM\_EC\_INT**

8-character field containing the interrupt code and ILC

**SRP\_SYSTEM\_REGST**

64-character field containing the contents of the GP registers

**SRP\_SYSTEM\_EXEC\_KEY**

1 byte containing the PSW key, in the form X'0n'.

**SRP\_ERROR\_FP\_REGS**

An area describing the contents of the floating point registers at the time of the abend. It contains:

**SRP\_FP\_REG\_0**

FP register 0

**SRP\_FP\_REG\_2**

FP register 2

**SRP\_FP\_REG\_4**

FP register 4

**SRP\_FP\_REG\_6**

FP register 6.

**Note:**

1. If flag SRP\_NOT\_CICS\_RB is set, SRP\_CICS\_ERROR\_DATA describes the last thing that CICS did, prior to the abend; SRP\_SYSTEM\_ERROR\_DATA describes the last thing that the system service (for example, VTAM, VSAM, or MVS) did.

2. The format of SRP\_ERROR\_DATA is shown in the *CICS Data Areas* manual.

### Return codes

#### **UERCNOCA**

Abnormally terminate the task with abend code 'ASRB'. Do not cancel any program-level abend exits that are associated with this task.

#### **UERCANC**

Abnormally terminate the task with abend code 'ASRB'. Cancel any program-level abend exits that are associated with this task.

#### **UERCICS**

Abnormally terminate CICS.

### XPI calls

Because CICS invokes the exit XSRAB in an error environment, you can only use a subset of the XPI calls.

Only TRACE\_PUT is available for general use.

You can use WAIT\_MVS, but only after the exit program has determined (from the SRP\_CICS\_CODE and SRP\_USER\_CODE fields) that the abend has occurred in user application code, and not in CICS code.

### Important

#### Note:

1. Take care when coding a program to run at the XSRAB exit point. If your exit program causes the system recovery program to be reentered (if, for example, a program check occurs) then CICS terminates abnormally, with a DFHSR06xx message.
2. The default return code is 'UERCNOCA'. This ensures that the task abends if the exit is in error.
3. There is no 'UERCNORM' return code at this exit point, because the exit is invoked after a failure.
4. The exit should not set the return code 'UERCPURG'.

## System termination program exit XSTERM

The XSTERM exit could be used to output final statistics to your statistics SMF data sets, and to close them. (Note that CICS VSAM and BDAM data sets have already been closed by CICS file control before the exit is invoked.)

### Exit XSTERM

#### When invoked

During the second quiesce stage of a normal system shutdown, immediately before the transient data and temporary storage buffers are cleared. The exit is not invoked during an IMMEDIATE shutdown.

#### Exit-specific parameters

None.

#### Return codes

#### **UERCNORM**

Continue processing.

### XPI calls

All other XPI calls except WRITE\_JOURNAL\_DATA can be used. However, their use is not recommended, because they could cause the task to lose control, thus allowing another task to write more monitoring data.

## Temporary storage domain exits XTSQRIN, XTSQROUT, XTSPTIN, and XTSPTOUT

The temporary storage domain exits XTSQRIN, XTSQROUT, XTSPTIN, and XTSPTOUT allow you to:

- Specify, for a request that creates a queue, whether the queue is to be held in main or auxiliary storage, and its recoverability
- Monitor the use of temporary storage
- Control security for temporary storage queues.

The temporary storage domain has two main gates, TSQR, and TSPT, which support the following functions:

**TSQR** Write, Rewrite, Read\_into, Read\_set, Read\_next\_into, Read\_next\_set, Delete.

**TSPT** Put, Put\_replace, Get, Get\_set, Get\_release, Get\_release\_set, Release.

The TSQR functions correspond to those available through the EXEC CICS interface (or through DFHTS TYPE=PUTQ, GETQ, or PURGE). The TSPT functions are used by the interval control program in support of START and RETRIEVE functions (or DFHTS TYPE=PUT, GET, or RELEASE).

### Exit XTSQRIN

#### When invoked

Before execution of a user temporary storage interface request for a user TS queue (for example, a WRITEQ TS, or READQ TS request).

#### Exit-specific parameters

##### UEPTRANID

Address of the 4-byte transaction ID.

##### UEPUSER

Address of the 8-byte user ID.

##### UEPTERM

Address of the 4-byte terminal ID.

##### UEPPROG

Address of the 8-byte application program name.

##### UEP\_TS\_FUNCTION

Address of a byte containing the function:

- UEP\_TS\_FUN\_WRITE
- UEP\_TS\_FUN\_REWRITE
- UEP\_TS\_FUN\_READ\_INTO
- UEP\_TS\_FUN\_READ\_SET
- UEP\_TS\_FUN\_READ\_NEXT\_INTO
- UEP\_TS\_FUN\_READ\_NEXT\_SET
- UEP\_TS\_FUN\_DELETE

**UEP\_TS\_QUEUE\_NAME**

Address of a 16-byte field containing the queue name.

**UEP\_TS\_DATA\_P**

Address of a fullword containing the address of the data. (Write and rewrite requests).

**UEP\_TS\_DATA\_L**

Address of a fullword containing the length of the data. (Write and rewrite requests).

**UEP\_TS\_ITEM\_NUMBER**

Address of a fullword containing the item number. (Rewrite, read\_into and read\_set requests).

**UEP\_TS\_STORAGE\_TYPE**

Address of a byte containing the storage type. (Write requests).

On input to the exit, the parameter will be set to either UEP\_TS\_STORAGE\_TYPE\_MAIN or UEP\_TS\_STORAGE\_TYPE\_AUX\_TST. This parameter may be modified by the exit to any of the values below.

Note that if CICS has been initialized with TS main-only support, setting this parameter has no effect.

**UEP\_TS\_STORAGE\_TYPE\_MAIN**

Main storage.

**UEP\_TS\_STORAGE\_TYPE\_AUX\_TST**

Auxiliary storage (recoverability determined by the TST).

**UEP\_TS\_STORAGE\_TYPE\_AUX\_RECOV\_YES**

Auxiliary storage (recoverable).

**UEP\_TS\_STORAGE\_TYPE\_AUX\_RECOV\_NO**

Auxiliary storage (non-recoverable).

**Return codes****UERCNORM**

Normal.

**UERCPURG**

Purged.

**XPI calls**

All can be used.

**API and SPI calls**

None can be used.

**Exit XTSQRROUT****When invoked**

After execution of a user temporary storage interface request for a user TS queue (for example, a WRITEQ TS, or READQ TS request).

**Exit-specific parameters****UEPTRANID**

Address of the 4-byte transaction ID.

**UEPUSER**

Address of the 8-byte user ID.

**UEPTERM**

Address of the 4-byte terminal ID.

**UEPPROG**

Address of the 8-byte application program name.

**UEP\_TS\_FUNCTION**

Address of a byte containing the function:

- UEP\_TS\_FUN\_WRITE
- UEP\_TS\_FUN\_REWRITE
- UEP\_TS\_FUN\_READ\_INTO
- UEP\_TS\_FUN\_READ\_SET
- UEP\_TS\_FUN\_READ\_NEXT\_INTO
- UEP\_TS\_FUN\_READ\_NEXT\_SET
- UEP\_TS\_FUN\_DELETE

**UEP\_TS\_QUEUE\_NAME**

Address of a 16-byte field containing the queue name.

**UEP\_TS\_DATA\_P**

Address of a fullword containing the address of the data. (All requests except delete).

**UEP\_TS\_DATA\_L**

Address of a fullword containing the length of the data. (All requests except delete).

**UEP\_TS\_ITEM\_NUMBER**

Address of a fullword containing the item number. (Rewrite, read\_into and read\_set requests).

**UEP\_TS\_TOTAL\_ITEMS**

Address of a fullword containing the total number of items in the queue. (All requests except delete).

**UEP\_TS\_RESPONSE**

Address of a byte containing the response after a request has been completed.

- UEP\_TS\_RESPONSE\_OK
- UEP\_TS\_RESPONSE\_PURGED
- UEP\_TS\_RESPONSE\_EXCEPTION
- UEP\_TS\_RESPONSE\_DISASTER
- UEP\_TS\_RESPONSE\_INVALID

**Return codes****UERCNORM**

Normal response.

**UERCPURG**

A purged response was received from an XPI request.

**XPI calls**

All can be used.

**API and SPI calls**

None can be used.

## Exit XTSPTIN

### When invoked

Before execution of a temporary storage interface request for a CICS internal queue (for example, for interval control or BMS queues).

### Exit-specific parameters

#### UEPTRANID

Address of the 4-byte transaction ID.

#### UEPUSER

Address of the 8-byte user ID.

#### UEPTERM

Address of the 4-byte terminal ID.

#### UEPPROG

Address of the 8-byte application program name.

#### UEP\_TS\_FUNCTION

Address of a byte containing the function:

- UEP\_TS\_FUN\_PUT
- UEP\_TS\_FUN\_PUT\_REPLACE
- UEP\_TS\_FUN\_GET
- UEP\_TS\_FUN\_GET\_SET
- UEP\_TS\_FUN\_GET\_RELEASE
- UEP\_TS\_FUN\_GET\_RELEASE\_SET
- UEP\_TS\_FUN\_RELEASE

#### UEP\_TS\_QUEUE\_NAME

Address of a 16-byte field containing the queue name.

#### UEP\_TS\_DATA\_P

Address of a fullword containing the address of the data. (Put and put\_replace).

#### UEP\_TS\_DATA\_L

Address of a fullword containing the length of the data. (Put and put\_replace).

#### UEP\_TS\_STORAGE\_TYPE

Address of a byte containing the storage type. (Put requests).

On input to the exit, the parameter will be set to either UEP\_TS\_STORAGE\_TYPE\_MAIN or UEP\_TS\_STORAGE\_TYPE\_AUX\_TST. This parameter may be modified by the exit to any of the values below.

Note that if CICS has been initialized with TS main-only support, setting this parameter has no effect.

#### UEP\_TS\_STORAGE\_TYPE\_MAIN

Main storage.

#### UEP\_TS\_STORAGE\_TYPE\_AUX\_TST

Auxiliary storage (recoverability determined by the TST).

#### UEP\_TS\_STORAGE\_TYPE\_AUX\_RECOV\_YES

Auxiliary storage (recoverable).

#### UEP\_TS\_STORAGE\_TYPE\_AUX\_RECOV\_NO

Auxiliary storage (non-recoverable).



## Return codes

### **UERCNORM**

Normal.

### **UERCPURG**

Task purged during XPI call.

## XPI calls

All can be used.

## API and SPI calls

None can be used.

## Exit XTSPTOUT

### When invoked

After execution of a temporary storage interface request for a CICS internal queue (for example, for interval control or BMS queues). After execution of a TSPT request. No parameters may be modified.

### Exit-specific parameters

#### **UEPTRANID**

Address of the 4-byte transaction ID.

#### **UEPUSER**

Address of the 8-byte user ID.

#### **UEPTERM**

Address of the 4-byte terminal ID.

#### **UEPPROG**

Address of the 8-byte application program name.

#### **UEP\_TS\_FUNCTION**

Address of a byte containing the function:

- UEP\_TS\_FUNCTION\_PUT
- UEP\_TS\_FUN\_PUT\_REPLACE
- UEP\_TS\_FUN\_GET
- UEP\_TS\_FUN\_GET\_SET
- UEP\_TS\_FUN\_GET\_RELEASE
- UEP\_TS\_FUN\_GET\_RELEASE\_SET
- UEP\_TS\_FUN\_RELEASE

#### **UEP\_TS\_QUEUE\_NAME**

Address of a 16-byte field containing the queue name.

#### **UEP\_TS\_DATA\_P**

Address of a fullword containing the address of the data. (All requests except release).

#### **UEP\_TS\_DATA\_L**

Address of a fullword containing the length of the data. (All requests except release).

#### **UEP\_TS\_RESPONSE**

Address of a byte containing the response after a request has been completed.

- UEP\_TS\_RESPONSE\_OK
- UEP\_TS\_RESPONSE\_PURGED

- UEP\_TS\_RESPONSE\_EXCEPTION
- UEP\_TS\_RESPONSE\_DISASTER
- UEP\_TS\_RESPONSE\_INVALID

#### **Return codes**

##### **UERCNORM**

Normal response.

##### **UERCPURG**

A purged response was received from an XPI request.

#### **XPI calls**

All can be used.

#### **API and SPI calls**

None can be used.

## **Temporary storage EXEC interface program exits XTSERREQ and XTSEREQC**

The XTSERREQ exit allows you to intercept temporary storage API requests before any action has been taken on the request. The XTSEREQC exit allows you to intercept the response after a temporary storage API request has completed.

The API requests affected are:

- EXEC CICS WRITEQ TS
- EXEC CICS READQ TS
- EXEC CICS DELETEQ TS.

Using XTSERREQ, you can:

- Analyze the API parameter list (function, keywords, argument values, and responses)
- Modify any input parameter value prior to execution of a request
- Prevent execution of a request.

Using XTSEREQC, you can:

- Analyze the API parameter list
- Modify any output parameter value after request completion.

You can also:

- Pass data between your XTSERREQ and XTSEREQC exit programs when they are invoked for the same request
- Pass data between your temporary storage exit programs when they are invoked within the same task.

It is possible that programs invoked from the exits in the temporary storage domain (XTSQRIN, XTSQRROUT, XTSPTIN, and XTSPTOUT) could modify situations set up by XTSERREQ; therefore you must consider the order in which the exits are invoked.

If all the temporary storage exits are enabled, the order of invocation is as follows:

1. XTSERREQ
2. XTSQRIN
3. XTSQRROUT
4. XTSEREQC

## Exit XTSEREQ

### When invoked

Before CICS processes a temporary storage API request.

### Exit-specific parameters

#### UEPCLPS

Address of a copy of the command parameter list. See “The command-level parameter structure” on page 215.

#### UEPTQOK

Address of a 4-byte area which can be used to pass information between XTSEREQ and XTSEREQC for a single temporary storage request.

#### UEPRCODE

Address of a 6-byte hexadecimal copy of the EIB return code EIBRCODE. For details of EIB return codes, see EIB fields, in the *CICS Application Programming Reference*.

#### UEPRES

Address of a 4-byte binary copy of the EIB response code EIBRESP.

#### UEPRES2

Address of a 4-byte binary copy of the EIB response code EIBRESP2.

#### UEPTSTOK

Address of a 4-byte token which can be used to pass information between successive temporary storage requests within the same task (for example, between successive invocations of the XTSEREQ exit).

#### UEPRECUR

Address of a halfword recursion counter. The counter is set to 0 when the exit is first invoked, and is incremented for each recursive call.

#### UEPRSRCE

Address of an 8-character copy of the EIB resource value, EIBRSRCE.

### Return codes

#### UERCBYP

Bypass this request.

#### UERCNORM

Continue processing.

#### UEPCPURG

Task purged during XPI call.

### XPI calls

All can be used.

### API and SPI commands

All can be used, except for:  
EXEC CICS SHUTDOWN  
EXEC CICS XCTL

**Note:** Take care when issuing recursive commands. For example, you must avoid entering a loop when issuing a temporary storage request from the XTSERREQ exit. Use of the recursion counter UEPRECUR is recommended.

## Exit XTSEREQC

### When invoked

After a temporary storage API request has completed, before return from the temporary storage EXEC interface program.

### Exit-specific parameters

#### UEPCLPS

Address of a copy of the command parameter list. See “The command-level parameter structure” on page 215.

#### UEPTQOK

Address of a 4-byte area which can be used to pass information between XTSERREQ and XTSEREQC for a single temporary storage request.

#### UEPRCODE

Address of a 6-byte hexadecimal copy of the EIB return code EIBRCODE. For details of EIB return codes, see EIB fields, in the *CICS Application Programming Reference*.

#### UEPRES

Address of a 4-byte binary copy of the EIB response code EIBRESP.

#### UEPRES2

Address of a 4-byte binary copy of the EIB response code EIBRESP2.

#### UEPTSTOK

Address of a 4-byte token which can be used to pass information between successive temporary storage requests within the same task (for example, between successive invocations of the XTSEREQC exit).

#### UEPRECUR

Address of a halfword recursion counter. The counter is set to 0 when the exit is first invoked, and is incremented for each recursive call.

#### UEPRSRCE

Address of an 8-character copy of the EIB resource value, EIBRSRCE.

#### UEP\_TS\_REMOTE\_SYSTEM

If the request is to be sent to a remote region, is the address of an area containing the 4-byte name of the remote region. (The remote region may have been specified by, for example, the SYSID option of the command, function shipping, or work-load management.)

If the request is to be executed on the local region, this parameter is the address of a 4-byte area containing blanks.

### Return codes

#### UERCNORM

Continue processing.

## **UERPURG**

Task purged during XPI call.

### **XPI calls**

All can be used.

### **API and SPI commands**

All can be used, except for:  
EXEC CICS SHUTDOWN  
EXEC CICS XCTL

You can update the copies of EIBRSRCE, EIBRCODE, EIBRESP, and EIBRESP2 that you are given in the parameter list. If you update the values, temporary storage copies the new values into the application program's EIB after the completion of XTSEREQC or if you specify a return code of UERCBYP in XTSEREQ.

You must set valid temporary storage responses. You must set all three of EIBRCODE, EIBRESP, and EIBRESP2 to a consistent set of values, such as would be set by temporary storage to describe a valid completion. CICS does not check the consistency of EIBRCODE, EIBRESP, and EIBRESP2. If EIBRCODE is set to a non-zero value and EIBRESP is set to zero, CICS will override EIBRESP with a non-zero value. To help you set values for EIBRCODE, EIBRESP, and EIBRESP2, the values used by temporary storage are specified in DSECT DFHTSUED.

**Note:** Take care when issuing recursive commands not to cause a loop. For example, it is your responsibility to avoid entering a loop when issuing a temporary storage request from the XTSEREQC exit. Use of the recursion counter UEPRECUR is recommended.

## **The command-level parameter structure**

The command-level parameter structure consists of a series of addresses. The first address points to the EXEC interface descriptor (EID), which consists of a bit string that describes the type of request and identifies each keyword specified with the request. The remaining addresses point to pieces of data associated with the request.

You can examine the EID to determine the type of request and the keywords specified. You can examine the other parameters in the list to determine the values of the keywords. You can also modify values of keywords specified on the request.

## **End of parameter list indicator**

The high-order bit is set on in the last address set in the parameter list to indicate that it is the last one in the list. On return from your user exit program, CICS scans the parameter list for the high-order bit to find the last parameter. Therefore, if you modify the length of the parameter list, you must also reset the high-order bit to indicate which is the new last address.

### ***The UEPCLPS exit-specific parameter:***

The UEPCLPS exit-specific parameter is included in both exit XTSEREQ and exit XTSEREQC. It is the address of the command-level parameter structure. The command-level parameter structure contains 8 addresses, TS\_ADDR0 through TS\_ADDR7. It is defined in the DSECT TS\_ADDR\_LIST, which you should copy into your exit program by including the statement COPY DFHTSUED.

The command-level parameter list is made up as follows.

**Note:** The relationship between arguments, keywords, data types, and input/output types is summarized for the temporary storage commands in the following tables:

*Table 9. The relationship between arguments, keywords, data types, and input/output types for the temporary storage commands*

Command	See
WRITEQ TS	Table 10 on page 219
READQ TS	Table 11 on page 220
DELETEQ TS	Table 12 on page 220

### **TS\_ADDR0**

is the address of a 9-byte area called the EID, which is made up as follows:

- **TS\_GROUP**
- **TS\_FUNCT**
- **TS\_BITS1**
- **TS\_BITS2**
- **TS\_EIDOPT5**
- **TS\_EIDOPT6**
- **TS\_EIDOPT7**
- **TS\_EIDOPT8**

### **TS\_GROUP**

Always X'0A', indicating that this is a temporary storage request.

### **TS\_FUNCT**

One byte that defines the type of request:

- X'02'** WRITEQ
- X'04'** READQ
- X'06'** DELETEQ

### **TS\_BITS1**

Existence bits that define which arguments were specified. To obtain the argument associated with a keyword, you need to use the appropriate address from the command-level parameter structure. Before using this address, you must check the associated existence bit. If the existence bit is set off, the argument was not specified in the request and the address should not be used.

- X'80'** Set if the request contains an argument for the QUEUE or QNAME keyword. If set, **TS\_ADDR1** is meaningful.
- X'40'** Set if the request contains an argument for any of the FROM, INTO, or SET keywords. If set, **TS\_ADDR2** is meaningful.
- X'20'** Set if the request contains an argument for the LENGTH keyword. If set, **TS\_ADDR3** is meaningful.
- X'10'** Set if the request contains an argument for the NUMITEMS keyword. If set, **TS\_ADDR4** is meaningful.
- X'08'** Set if the request contains an argument for the NUMITEMS or ITEM keyword. If set, **TS\_ADDR5** is meaningful.

**X'02'** Set if the request contains an argument for the SYSID keyword. If set, **TS\_ADDR7** is meaningful.

**TS\_BITS2**

Two bytes not used by temporary storage.

**TS\_EIDOPT5**

Indicates whether certain keywords were specified on the request.

**X'80'** QNAME was specified (otherwise QUEUE). You can modify this bit in your user exit if you wish.

**TS\_EIDOPT6**

One byte not used by temporary storage.

**TS\_EIDOPT7**

Indicates whether certain functions and/or keywords were specified on the request.

**X'10'** WRITEQ NOSUSPEND specified.

**X'80'** WRITEQ MAIN or READQ ITEM specified.

**X'04'** WRITEQ REWRITE or READQ NUMITEMS specified.

**TS\_EIDOPT8**

Indicates whether certain keywords were specified on the request.

**X'80'** ITEM was specified (otherwise NUMITEMS).

**TS\_ADDR1**

is the address of area containing 8-byte name from QUEUE. or 16-byte name from QNAME. To determine which of these is applied, see the **TS\_BITS2** field.

**TS\_ADDR2**

is the address of one of the following:

- A 4-byte address from SET (if the request is READQ and **TS\_EIDOPT5** indicates that this is SET).
- Data from INTO (if the request is READQ and **TS\_EIDOPT5** indicates that this is not SET).
- Data from FROM (if the request is WRITEQ).

**TS\_ADDR3**

is the address of the halfword value of LENGTH (if the request is READQ or WRITEQ).

**Warning:** For requests that specify INTO, do not change the value of LENGTH to a value greater than that specified by the application. To do so causes a storage overlay in the application.

**TS\_ADDR4**

is the address of the halfword value of NUMITEMS (if the request is READQ).

**TS\_ADDR5**

is the address of one of the following:

- The halfword value of NUMITEMS (if the request is WRITEQ)
- The halfword value of ITEM (if the request is READQ or WRITEQ).

**TS\_ADDR6**

is the address of a value intended for CICS internal use only. It must not be used.

## TS\_ADDR7

is the address of an area containing the value of SYSID.

**Modifying fields in the command-level parameter structure:** Some fields that are passed to temporary storage are used as input to the request, some are used as output fields, and some are used for both input and output. The method your user exit program uses to modify a field depends on the usage of the field.

The following are always input fields:

- QUEUEIQNAME
- FROM
- SYSID

The following are always output fields:

- INTO
- NUMITEMS
- SET

LENGTH is an input field on a WRITEQ request, and an output field on a READQ request that specifies SET. It is both an input and an output field on a READQ request that specifies INTO.

ITEM is an input field on a READQ request, and on a WRITEQ request that specifies REWRITE. It is both an input and an output field on a WRITEQ request that does not specify REWRITE.

**Modifying input fields:** The correct method of modifying an input field is to create a new copy of it, and to change the address in the command-level parameter list to point to your new data.

**Note:** You must never modify an input field by altering the data that is pointed to by the command-level parameter list. To do so would corrupt storage belonging to the application program and would cause a failure when the program attempted to reuse the field.

**Modifying output fields:** The technique described in “Modifying input fields” is not suitable for modifying output fields. (The results would be returned to the new area instead of the application’s area, and would be invisible to the application.)

An output field is modified by altering the data that is pointed to by the command-level parameter list. In the case of an output field, you can modify the application’s data in place, because the application is expecting the field to be modified anyway.

**Modifying fields used for both input and output:** An example of a field that is used for both input and output is LENGTH on a READQ request that specifies INTO. You can treat such fields in the same way as output fields, and they are considered to be the same.

**Modifying the EID:** It is not possible to modify the EID to make major changes to requests. It is not possible, for example, to change a READQ request to a WRITEQ request.



However, you can make minor changes to requests, such as to turn on the existence bit for SYSID so that the request can be changed into one that is shipped to a remote system.

The list that follows shows the bits in the EID that can be modified. Any attempt to modify any other part of the EID is ignored.

**TS\_BITS1**

**X'02'** The existence bit for SYSID.

**TS\_EIDOPT7**

A user exit program at XTSERREQ can set the following on or off for all WRITEQ TS commands:

**X'10'** The existence bit for NOSUSPEND.

**X'08'** The existence bit for MAIN.

The EID is reset to its original value before return to the application program. That is, changes made to the EID are retained for the duration of the temporary storage request only.

**Note:** Your user exit program is prevented from making major changes to the EID. However, you must take great care when making the minor modifications that **are** permitted.

**Use of the task token UEPTSTOK:** UEPTSTOK provides the address of a 4-byte area that you can use to pass information between successive temporary storage requests in the same task. (By contrast, UEPTQTOK is usable only for the duration of a single temporary storage request, because its contents may be destroyed at the end of the request.) For example, if you need to pass information between successive invocations of the XTSERREQ exit, UEPTSTOK provides a means of doing this.

*Table 10. WRITEQ TS: User arguments and associated keywords, data types, and input/output types*

Argument	Keyword	Data type	Input/output type
Arg1	QUEUE	CHAR(8)	input
Arg1	QNAME	CHAR(16)	input
Arg2	FROM	DATA-AREA	input
Arg3	LENGTH	BIN(15)	input
Arg4	*	*	*
Arg5	ITEM	BIN(15)	input/output
Arg5	NUMITEMS	BIN(15)	output
Arg6	*	*	*
Arg7	SYSID	CHAR(4)	input

**Note:** The different uses of Arg5 are shown, because Arg5 is used by the ITEM and NUMITEMS keywords which are alternatives and the argument to the ITEM keyword is an input field when REWRITE is specified.

Table 11. READQ TS: User arguments and associated keywords, data types, and input/output types

Argument	Keyword	Data type	Input/output type
Arg1	QUEUE	CHAR(8)	input
Arg1	QNAME	CHAR(16)	input
Arg2	SET	DATA-AREA, PTR	output
Arg2	INTO	DATA-AREA	output
Arg3	LENGTH	BIN(15)	input/output
Arg4	NUMITEMS	BIN(15)	output
Arg5	ITEM	BIN(15)	input
Arg6	*	*	
Arg7	SYSID	CHAR(4)	input

Table 12. DELETEQ TS: User arguments and associated keywords, data types, and input/output types

Argument	Keyword	Data type	Input/output type
Arg1	QUEUE	CHAR(8)	input
Arg1	QNAME	CHAR(16)	input
Arg2	*	*	*
Arg3	*	*	*
Arg4	*	*	*
Arg5	*	*	*
Arg6	*	*	*
Arg7	SYSID	CHAR(4)	input

**Modifying user arguments:** User exit programs can modify user arguments, as follows:

For input arguments, the user exit program should obtain sufficient storage to hold the modified argument, set up that storage to the required value, and set the associated pointer in the parameter list to the address of the newly acquired area.

For output arguments, and for input/output arguments, the user exit program can update the argument in place, because the area of storage is represented by a variable in the application which is expected to receive a value from CICS.

**Note:**

1. CICS does not check changes to argument values, so any changes must be verified by the user exit program making the changes.
2. It is not advisable for XTSEREQ to modify output arguments or for XTSEREQC to modify input arguments.

**Adding user arguments:** Global user exit programs can add arguments associated with the SYSID keyword. You must ensure that the arguments you specify or modify in your exit programs are valid.

Assuming that the argument to be added does not already exist, the user exit program must:

1. Obtain storage for the argument to be added
2. Initialize the storage to the required value
3. Select and set up the appropriate pointer from the parameter list
4. Select and set up the appropriate argument existence bit in the EID
5. Modify the parameter list to reflect the new end of list indicator.

**Removing user arguments:** User exit programs can remove arguments (for which the program is totally responsible) associated with the SYSID keyword:

Assuming that the argument to be removed exists, the user exit program must:

1. Switch the corresponding argument existence bit to '0'b in the EID
2. Modify the parameter list to reflect the new end of list indicator.

### Example program

CICS supplies—as a softcopy listing only (not as a source code file)—an example program, DFH\$XTSE, that shows how temporary storage requests can be modified. See Appendix F, “The example program for the XTSEREQ global user exit, DFH\$XTSE,” on page 877.

## Terminal allocation program exit XALCAID

XALCAID is driven when an automatic initiation descriptor (AID) with data is canceled in one of the following ways:

- By means of the CEMT transaction
- During execution of a SET TERMINAL or SET CONNECTION command
- During reinstallation of a terminal or connection.

XALCAID is invoked only if there is data associated with the AID.

### Exit XALCAID

#### When invoked

Whenever an AID with data is canceled.

**Note:** It is not possible for the exit to prevent the request from being canceled.

#### Exit-specific parameters

##### UEPALTSD

Address of a 4-byte field containing the symbolic identifier of the transaction which was to be started by this request.

##### UEPALTRM

Address of a 4-byte field containing the identifier of the terminal or connection to which this request was directed.

##### UEPALDAT

Address of an area of storage containing the data specified in the FROM option; or hexadecimal zeros, in either of the following cases:

- The AID was created by a START request without a FROM option.
- The AID is associated with a channel (in which case the field pointed to by UEPALCHN will be set to a name other than blanks).

**UEPALLEN**

Address of a fullword binary field containing the length of the FROM data; or hexadecimal zeros, in either of the following cases:

- The AID was created by a START request without a FROM option.
- The AID is associated with a channel (in which case the field pointed to by UEPALCHN will be set to a name other than blanks).

**UEPALRQD**

Address of an 8-byte field containing the value of the REQID associated with the FROM data. The data was stored in a temporary storage queue with this name. This value was either specified explicitly using the REQID option on the START command, or created internally by CICS.

**UEPALQUE**

Address of an 8-byte field containing the value specified in the QUEUE option on the START command; or hexadecimal zeros if QUEUE was not specified.

**UEPALRTE**

Address of a 4-byte field containing the value specified in the RTERMID option on the START command, or hexadecimal zeros if RTERMID was not specified.

**UEPALRTA**

Address of a 4-byte field containing the value specified in the RTRANSID option on the START command, or hexadecimal zeros if RTRANSID was not specified.

**UEPALFMH**

Address of a 1-byte field containing the value X'FF' if the data contains FMHs, as specified by the FMH option on the associated START command; or hexadecimal zeros otherwise.

**UEPALSTC**

Address of a 2-byte field containing the start code. This is "SZ" for FEPI starts; otherwise it is "SD".

**UEPALCHN**

Address of a 16-byte field containing the name of the channel associated with the AID. If there is no channel associated with the AID, this field is set to blanks.

**Return codes****UERCNORM**

No other return codes are supplied. The value of the return code is not inspected.

**XPI calls**

You can use:

- INQ\_APPLICATION\_DATA
- INQUIRE\_SYSTEM

No other XPI calls should be used.

**API and SPI commands**

No EXEC CICS commands can be used.

**Note:** The XALTENF exit, used to handle the “terminal not known” condition, is also invoked from the terminal allocation program. XALTENF is described on page “Terminal not known’ condition exits XALTENF and XICTENF” on page 224.

## Terminal control program exits XTCIN, XTCOUT, and XTCATT

### Exit XTCIN

#### When invoked

After an input event for a sequential device.

#### Exit-specific parameters

##### UEPTCTTE

Address of the terminal control table terminal entry (TCTTE). The TCTTE can be mapped using the DSECT DFHTCTTE.

##### UEPTIOA

Address of the terminal input/output area (TIOA). Your exit program should not change the address. The TIOA can be mapped using the DSECT DFHTIOA. However, fields TIOASAL and TIOASCA are **not** programming interfaces.

##### UEPTCTLE

Address of the terminal control table line entry (TCTLE). The TCTLE can be mapped using the DSECT DFHTCTLE.

#### Return codes

##### UERCNORM

Continue processing.

#### XPI calls

All can be used. However, note that you cannot use a GETMAIN call to obtain terminal-class storage for use as a replacement TIOA.

### Exit XTCOUT

#### When invoked

Before an output event for a sequential device.

#### Exit-specific parameters

##### UEPTCTTE

Address of the terminal control table terminal entry (TCTTE). The TCTTE can be mapped using the DSECT DFHTCTTE.

##### UEPTIOA

Address of the terminal input/output area (TIOA). Your exit program should not change the address. The TIOA can be mapped using the DSECT DFHTIOA. However, fields TIOASAL and TIOASCA are **not** programming interfaces.

##### UEPTCTLE

Address of the terminal control table line entry (TCTLE). The TCTLE can be mapped using the DSECT DFHTCTLE.

#### Return codes

##### UERCNORM

Continue processing.

### XPI calls

All can be used. However, note that you cannot use a GETMAIN call to obtain terminal-class storage for use as a replacement TIOA.

### Exit XTCATT

#### When invoked

Before task attach.

#### Exit-specific parameters

##### UEPTCTTE

Address of the terminal control table terminal entry (TCTTE). The TCTTE can be mapped using the DSECT DFHTCTTE.

##### UEPTIOA

Address of the terminal input/output area (TIOA). The TIOA can be mapped using the DSECT DFHTIOA. However, fields TIOASAL and TIOASCA are **not** programming interfaces.

##### UEPTCTLE

Address of the terminal control table line entry (TCTLE). The TCTLE can be mapped using the DSECT DFHTCTLE.

##### UEPTRAN

Address of the 4-byte transaction id.

#### Return codes

##### UERCNORM

Continue processing.

### XPI calls

All can be used.

## 'Terminal not known' condition exits XALTENF and XICTENF

The 'terminal not known' condition can occur when intercommunicating CICS regions use both SHIPPABLE terminal definitions and automatic transaction initiation (ATI). The condition is especially likely to arise if autoinstall is used.

#### SHIPPABLE attribute

Terminals defined with the SHIPPABLE attribute in a terminal-owning region (TOR) do not need a definition in a connected application-owning region (AOR). If necessary to support transaction routing, CICS ships a copy of the definition from the TOR to the AOR. For further information, refer to the *CICS Intercommunication Guide*.

#### Automatic transaction initiation (ATI)

ATI occurs when an internally generated request leads to the initiation of a transaction. For example, when:

- An application issues an EXEC CICS START command, or
- The transient data trigger level is reached.

Two CICS modules handle ATI requests:

The **interval control program** processes a START command, checks that the terminal is known in the local system, and (when any START time interval elapses) calls the terminal allocation program.

The **terminal allocation program** is called by the interval control program or by the transient data triggering mechanism, and checks that the terminal is known

in the local system. If the requested terminal is remote, the terminal allocation program ships an ATI request to the remote system, which initiates transaction routing back to the local system.

For guidance information about ATI, refer to the *CICS Intercommunication Guide*.

#### **'Terminal not known' condition**

The 'terminal not known' condition arises when an ATI request is made for a terminal not known in the region. An ATI request can occur in the AOR for a SHIPPABLE terminal before any transaction routing has taken place for the terminal, and so before the definition of the terminal can have been shipped from the TOR to the AOR.

If the 'terminal not known' condition occurs, both the interval control program and the terminal allocation program reject the transaction-initiation request as 'TERMIDERR'.

### **The exits**

To deal with the 'terminal not known' condition, CICS provides global user exits in the interval control and terminal allocation programs:

#### **XICTENF**

In the interval control program

#### **XALTENF**

In the terminal allocation program.

CICS drives the XICTENF exit when the 'terminal not known' condition occurs after the interval control program has been invoked by an EXEC CICS START command. CICS drives the XALTENF exit when the 'terminal not known' condition occurs after the terminal allocation program has been invoked by the transient data trigger level or the interval control program. Note that an EXEC CICS START command could result in both exits being invoked.

The exit program must indicate whether the terminal exists on another system and, if so, on which one. CICS passes data to the exit program to help establish this information. You can use the same exit program at both exit points. CICS supplies a sample exit program, DFHXTENF (see Figure 2 on page 231), that can be used at both exits and that can deal unchanged with some typical situations.

The exits are designed to deal with 'terminal not known' conditions that occur in CICS regions other than the TOR. For a TOR/AOR pair, enable the exit program in the AOR. The exits cannot deal with a 'terminal not known' condition in the TOR and the exit program should not normally be enabled there. However, if more than one TOR exists, you may need to enable the exit program in each TOR to deal with requests for terminals owned by other TORs. In this case, the exit program must recognize terminals that should be owned by this system and reject the requests ('UERCTEUN'). Although the exit provides as much data as possible, the logic of your program depends entirely on your system design. A simple solution to the most complex case would be to make the name of each terminal reflect the netname or sysid of its owning region.

**Data returned by exit:** The exit program must set a return code in register 15 as follows:

#### **UERCTEUN**

Terminal does not exist

**UERCNETN**

Netname of TOR returned

**UERCYSI**

Sysid of TOR returned.

For return codes UERCNETN and UERCYSI, the exit program must place the netname or sysid of the terminal-owning region in fields UEPxxNTO or UEPxxSYO (where xx is AL or IC).

If the terminal-owning region is a member of a VTAM generic resource, the exit program should place the netname of the terminal in field UEPxxNNO. For information about using ATI with VTAM generic resources, see Using ATI with generic resources, in the *CICS Intercommunication Guide*.

**Exit XALTENF****When invoked**

By the terminal allocation program when the terminal that an ATI request from transient data or interval control requires is unknown in this system. The exit program is expected to give a return code indicating whether the terminal exists on another connected CICS system and, if so, on which one.

**Exit-specific parameters****UEPALEVT**

Address of 2 bytes containing the type of request. The equated values of the types are:

**UEPALESD**

START command with data

**UEPALES**

START command without data

**UEPALETD**

Transient data trigger level reached.

**UEPALTR**

Address of 1 byte containing an indication of whether the task issuing the START command was started by transaction routing. The equated values are:

**UEPALTY**

A START command was being processed and the task issuing the command was transaction routed to.

**UEPALTN**

A START command was not being processed **or** a START command was being processed but the task issuing the command was not transaction routed to.

**UEPALFS**

Address of 1 byte containing an indication of whether the START command was function shipped. The equated values are:

**UEPALFY**

A START command was being processed and the START was function shipped.

**UEPALFN**

A START command was not being processed **or** a START was being processed but it was not function shipped.



**UEPALTRN**

Address of 4 bytes containing the name of the transaction to be run.

**UEPALRTR**

Address of 4 bytes containing the name of the terminal on which the transaction should run. (If a transient data trigger level was reached and the transient data queue definition specified a system, then this would contain a system identifier.)

**UEPALCTR**

Address of 4 bytes containing, for START commands, the name of the current terminal if the command was transaction routed, or the name of the session if the command was function shipped.

For other START commands and for transient data trigger events, the field pointed to contains blanks.

**UEPALNTI**

Address of 8 bytes containing, for function-shipped START commands, the netname of the last system from which the request came.

For START commands issued in this system by transaction routing to a task, the netname of the last system from which the task was routed.

For other START command situations and for transient data trigger level events, the field pointed to contains blanks.

**UEPALSXI**

Address of 4 bytes containing, if UEPALNTI contains a netname, the corresponding sysid.

If UEPALNTI does not contain a netname, the field pointed to is blank.

**UEPALNTO**

Address of 8 bytes containing the contents of UEPALNTI.

**If it sets a return code of 'UERCNETN', your exit program must place in this field the netname of the system to which the ATI request should be sent.**

**UEPALSXI**

Address of 4 bytes containing the contents of UEPALSXI.

**If it sets a return code of 'UERCSYSI', your exit program must place in this field the sysid of the system to which the ATI request should be sent.**

**UEPALNNI**

Address of a 4-byte input field containing the netname of the terminal on which the transaction is to run, if this is known to CICS. If CICS does not know the netname, the addressed field contains blanks.

**UEPALNNO**

Address of a 4-byte input/output field containing, on invocation, the contents of UEPALNNI. Your exit program can use this field to supply the netname of the terminal on which the transaction is to

run. It is important that your exit program supply a terminal netname if the TOR to which it directs the ATI request is a member of a VTAM generic resource.

### Return codes

#### **UERCTEUN**

Terminal unknown, reject request.

#### **UERCNETN**

Terminal known, netname returned in UEPALNTO.

#### **UERCYSYSI**

Terminal known, sysid returned in UEPALSYO.

### XPI calls

You can use:

- INQ\_APPLICATION\_DATA
- INQUIRE\_SYSTEM.

No other XPI calls should be used.

### Exit XICTENF

#### When invoked

By the interval control program when the terminal that an EXEC CICS START command requires is unknown in this system. The exit program is expected to give a return code indicating whether the terminal exists on another connected CICS system and, if so, on which one.

#### Exit-specific parameters

##### **UEPICEVT**

Address of 2 bytes containing the type of request. The equated values of the types are:

##### **UEPICESD**

START command with data

##### **UEPICES**

START command without data.

##### **UEPICTR**

Address of 1 byte containing an indication of whether the task issuing the START command was started by transaction routing. The equated values are:

##### **UEPICTY**

A START command was being processed and the task issuing the command was transaction routed to.

##### **UEPICTN**

A START command was not being processed **or** a START command was being processed but the task issuing the command was not transaction routed to.

##### **UEPICFS**

Address of 1 byte containing an indication of whether the START command was function shipped. The equated values are:

##### **UEPICFY**

A START command was being processed and the START was function shipped.

**UEPICFN**

A START command was not being processed **or** a START was being processed but it was not function shipped.

**UEPICTRN**

Address of 4 bytes containing the name of the transaction to be run.

**UEPICRTR**

Address of 4 bytes containing the name of the terminal on which the transaction should run.

**UEPICCTR**

Address of 4 bytes containing, for START commands, the name of the current terminal if the command was transaction routed, or the name of the session if the command was function shipped.

For other START commands, the field pointed to contains blanks.

**UEPICNTI**

Address of 8 bytes containing, for function-shipped START commands, the netname of the last system from which the request came.

For START commands issued in this system by transaction routing to a task, the netname of the last system from which the task was routed.

For other START command situations, the field pointed to contains blanks.

**UEPICSYI**

Address of 4 bytes containing, if UEPICNTI contains a netname, the corresponding SYSID.

If UEPICNTI does not contain a netname, the field pointed to is blank.

**UEPICNTO**

Address of 8 bytes containing the contents of UEPICNTI.

**If it sets a return code of 'UERCNETN', your exit program must place in this field the netname of the system to which the ATI request should be sent.**

**UEPICSYO**

Address of 4 bytes containing the contents of UEPICSYI.

**If it sets a return code of 'UERCYSYSI', your exit program must place in this field the sysid of the system to which the ATI request should be sent.**

**UEPICNNI**

Address of a 4-byte input field containing the netname of the terminal on which the transaction is to run, if this is known to CICS. If CICS does not know the netname, the addressed field contains blanks.

**UEPICNNO**

Address of a 4-byte input/output field containing, on invocation, the contents of UEPICNNI. Your exit program can use this field to supply the netname of the terminal on which the transaction is to

run. It is important that your exit program supply a terminal netname if the TOR to which it directs the ATI request is a member of a VTAM generic resource.

#### **Return codes**

##### **UERCTEUN**

Terminal unknown, reject request.

##### **UERCNETN**

Terminal known, netname returned in UEPICNTO.

##### **UERCYSI**

Terminal known, sysid returned in UEPICSYO.

##### **UERPURG**

Task purged during XPI call.

#### **XPI calls**

The following must not be used:

- ADD\_SUSPEND
- DELETE\_SUSPEND
- DEQUEUE
- ENQUEUE
- RESUME
- SUSPEND
- WAIT\_MVS.

#### **The sample program for the XALTENF and XICTENF exits, DFHXTENF**

One program can be used for both exits, or a separate program can be written for each. Figure 2 on page 231 shows the executable code from the supplied sample program DFHXTENF, which can be used for both exits. DFHXTENF rejects transient data requests, because the action in this case is very much installation-dependent.

```

DFHXTENF CSECT
          DFHVM XTENF
          ENTRY DFHXTENA
DFHXTENA DS    0H
          STM   R14,R12,12(R13)    save registers
          BALR  R11,0              set up base register
          USING *,R11

*
          USING DFHUEPAR,R1        DFHUEH parameter list
*
*      Could check the terminal ID at this point. In this
*      program we assume it is valid. We also choose to accept
*      START requests and reject Transient Data trigger level
*      events.
*
          L     R2,UEPICEVT        access type of request
          CLC   0(2,R2),START      START command?
          BE    STARTCMD          yes
*
          CLC   0(2,R2),STARTDAT   START command with data?
          BNE   NOTSTART          no, must be Transient Data
*
STARTCMD DS    0H
*
*      Accept the default netname if we are Function Shipping.
*      Otherwise build a netname.
*
          L     R2,UEPICFS         access FS information
          CLI   0(R2),UEPICFY      Function Shipping?
          BNE   BLDNETNM          no, build a netname
*
          LH   R15,NETNAME        accept the default netname
          B    EXIT
*BLDNETNM DS    0H
*
*      Build a netname by taking the first character of the
*      terminal ID and appending it to the characters 'CICS'.
*
          L     R2,UEPICNTO        access the output netname field
          L     R3,UEPICRTR        access ID of requested terminal
          MVC   0(8,R2),=C'CICS    '
          MVC   4(1,R2),0(R3)      first character of terminal ID
          LH   R15,NETNAME        netname returned
          B    EXIT
*
NOTSTART DS    0H
          LH   R15,UNKNOWN        reject Transient Data trigger
                                level events
*
EXIT     DS    0H
          L     R14,12(R13)        restore registers except 15
          LM    R0,R12,20(R13)     which contains the return code
          BR   R14
*
*****
*      Local constants
*****
START    DC    AL2(UEPICES)
STARTDAT DC    AL2(UEPICESD)
NETNAME  DC    AL2(UERCNETN)
UNKNOWN  DC    AL2(UERCTEUN)
*
          DFHEND DFHXTENF

```

Figure 2. Sample program for XALTENF and XICTENF exits

## Important

The example in Figure 2 on page 231 is intended purely as a demonstration of some of the possibilities available, and would be impractical in a production environment.

### Related concepts

“The terminal-not-known sample exit program” on page 25

## Transaction manager domain exit **XXMATT**

### Exit **XXMATT**

#### When invoked

During transaction attach. This exit is able to change some of the attributes of the transaction that is being attached.

The exit can change the attach transaction ID of the transaction by changing the field addressed by UEPATPTI. You cannot use **EXEC CICS** commands from this exit.

#### Exit-specific parameters

##### **UEPTRANID**

The address of transaction ID (see Notes).

##### **UEPUSER**

The address of the user ID associated with the transaction if the current task is a user task (see Notes).

##### **UEPTERM**

The address of the terminal ID associated with the transaction, if any (see Notes).

##### **UEPPROG**

The address of the application program name for this transaction, if any (see Notes).

##### **UEPATPTI**

The address of a 4 byte field containing the primary transaction id. You can change the primary transaction id by modifying the addressed field.

##### **UEPATOTI**

The address of the 4 byte attach transaction ID. A transid of X'00000000' indicates that a transid was not supplied on the attach.

##### **UEPATTPL**

The address of an area containing the length of the attach TPName. A length of zero indicates that a TPName was not supplied on the attach.

##### **UEPATTPA**

The address of a fullword containing the address of the attach TPName. The attach TPName can be 1 through 64 bytes long, as defined by UEPTTPL.

##### **UEPATLOC**

The address of a 1 byte field indicating whether the transaction was found. Note that if the transaction was *not* found but system initialization parameters DTRTRAN and DTRPGM are specified, the

transaction specified on DTRTRAN is attached and CICS considers that the transaction has been found.

Equated values are:

**UEATFND**

The transaction was found.

**UEATNFND**

The transaction was not found.

**UEPATTST**

The address of a 1 byte transaction definition state. Equated values for the definition state are:

**UEATENAB**

The transaction is enabled.

**UEATDISA**

The transaction is disabled.

**UEPATTTK**

The address of a doubleword containing a transaction token. Note that some of the transaction manager XPI calls require this token to identify the transaction that is being attached.

**Return codes**

**UERCNORM**

Continue attach processing.

**XPI calls**

The user exit can inquire on the transaction being attached, using the UEPATTTK transaction token as input to the XMIQ INQUIRE\_TRANSACTION XPI call.

The exit can also set the total priority and TCLASS, using the XMIQ SET\_TRANSACTION XPI call.

Most of the XPI calls can be used, but with caution since typically this exit is invoked under the TCP task. Thus it is advisable not to issue any XPI calls that might cause the TCP task to wait.

**Note:**

1. The following XPI calls can be useful for obtaining information that could be used to modify the attach of a transaction:
  - INQUIRE\_TRANSACTION
  - INQUIRE\_MXT
  - INQUIRE\_TCLASS
  - INQUIRE\_TRANDEF
  - INQUIRE\_SYSTEM
2. The fields UEPTRANID, UEPUSER, UEPTERM, and UEPPROG are common to many of the domain global user exit points, and normally return values associated with the current user task. In the case of XXMATT, however, the user task that is being attached is **not** the current task when the exit is invoked. Until task attach is complete, the current task is the CICS task that is performing the attach.

When the task being attached is for a task started by an immediate START command; that is, a START without an interval, the current task is the task that issues the START command, and the fields contain values associated with that task.

## Transient data program exits XTDREQ, XTDIN, and XTDOUT

### Exit XTDREQ

#### When invoked

Before request analysis.

#### Exit-specific parameters

##### UEPTDQUE

Address of 4-byte TD queue name.

##### UEPTDTYP

Address of 1-byte TD request type. Values are:

##### UEPTDPUT

PUT request

##### UEPTDGET

GET request

##### UEPTDPUR

PURGE request.

#### Return codes

##### UERCNORM

Continue TD processing.

##### UERCTDOK

Quit TD processing – returning 'NORMAL' to the caller.

##### UERCTDNA

Quit TD processing – returning 'NOTAUTH' to the caller.

##### UERCPURG

Task purged during XPI call.

#### XPI calls

You can use:

- INQ\_APPLICATION\_DATA
- INQUIRE\_SYSTEM
- WAIT\_MVS

**Do not use any other calls.**

### Exit XTDIN

#### When invoked

After receiving data from QSAM (for extrapartition) or VSAM (for intrapartition).

#### Exit-specific parameters

##### UEPTDQUE

Address of the 4-byte TD queue name.

##### UEPTDAUD

Address of the unmodified TD data.



**UEPTDLUD**

Address of the fullword length of the unmodified TD data.

**UEPTDAMD**

Address of the TD data modified by the exit program.

**UEPTDLMD**

Address of the fullword length of the TD data modified by the exit program.

**Return codes****UERCNORM**

Continue TD processing.

**UERCPURG**

Task purged during XPI call.

**XPI calls**

You can use:

- INQ\_APPLICATION\_DATA
- INQUIRE\_SYSTEM
- WAIT\_MVS

**Do not use any other calls.**

**Exit XTDOUT****When invoked**

Before passing the data to a QSAM (for extrapartition) or VSAM (for intrapartition) user-defined transient data queue.

**Exit-specific parameters****UEPTDQUE**

Address of the 4-byte TD queue name.

**UEPTDAUD**

Address of the unmodified TD data.

**UEPTDLUD**

Address of the fullword length of the unmodified TD data.

**UEPTDAMD**

Address of the TD data modified by the exit program.

**UEPTDLMD**

Address of the fullword length of TD data modified by the exit program.

**UEPTDNUM**

Address of the fullword containing the number of items in the list.

**UEPTDCUR**

Address of the fullword containing the number of the current item.

**Return codes****UERCNORM**

Continue TD processing.

**UERCTDOK**

Quit TD processing – returning 'NORMAL' to the caller.

**Note:** If you return UERCTDOK to suppress the first line of a multiline message, the rest of the message is not presented to XTDOU, but is also suppressed.

### **UERCPURG**

Task purged during XPI call.

### **XPI calls**

You can use:

- INQ\_APPLICATION\_DATA
- INQUIRE\_SYSTEM
- WAIT\_MVS

**Do not use any other calls.**

## **Transient data EXEC interface program exits XTDEREQ and XTDEREQC**

The XTDEREQ exit allows you to intercept a transient data request before any action has been taken on it by transient data. The XTDEREQC exit allows you to intercept a transient data request after transient data has completed its processing.

Using XTDEREQ, you can:

- Analyze the request to determine its type, the keywords specified, and their values.
- Modify any value specified by the request before the command is executed.
- Set return codes to specify that either:
  - CICS should continue with the (possibly modified) request.
  - CICS should bypass the request. (Note that if you set this return code, you must also set up return codes for the EXEC interface block (EIB), as if you had processed the request yourself.)

Using XTDEREQC, you can:

- Analyze the request, to determine its type, the keywords specified, and their values.
- Set return codes for the EIB.

Both exits are passed eight parameters as follows:

- The address of the command-level parameter structure
- The address of a token (UEPTDTOK) used to pass 4 bytes of data from XTDEREQ to XTDEREQC
- The addresses of copies of four pieces of return code and resource information from the EIB
- The address of a token (UEPTSTOK) that is valid throughout the life of a task
- The address of an exit recursion count (UEPRECUR).

### **Example program**

CICS supplies—as a softcopy listing only (not as a source code file)—an example program, DFH\$XTSE, that shows how to modify fields in the command-level parameter structure passed to EXEC interface exits. DFH\$XTSE is listed on page Appendix F, “The example program for the XTSEREQ global user exit, DFH\$XTSE,” on page 877.

## Exit XTDEREQ

### When invoked

Before CICS processes a transient data API request.

### Exit-specific parameters

#### UEPCLPS

Address of the command-level parameter structure. See “The UEPCLPS exit-specific parameter” on page 240.

#### UEPTDOK

Address of the 4-byte token to be passed to XTDEREQC. This allows you, for example, to pass a work area to exit XTDEREQC.

#### UEPRCODE

Address of a 6-byte hexadecimal copy of the EIB return code ‘EIBRCODE’. For details of EIB return codes, refer to EIB fields, in the *CICS Application Programming Reference* manual.

#### UEPRES

Address of a 4-byte binary copy of the EIB response code ‘EIBRESP’.

#### UEPRES2

Address of a 4-byte binary copy of the EIB response code ‘EIBRESP2’.

#### UEPTSTOK

Address of a 4-byte token that is valid throughout the life of a task. See “Use of the task token UEPTSTOK” on page 243.

#### UEPRECUR

Address of a halfword recursion counter. The counter is set to 0 when the exit is first invoked, and is incremented for each recursive call.

#### UEPRSRCE

Address of an 8-character copy of the EIB resource value, EIBRSRCE.

### Return codes

#### UERCNORM

Continue processing.

#### UERCBYP

The transient data EXEC interface program should ignore this request.

#### UERCPURG

Task purged during XPI call.

### XPI calls

All can be used.

Although the exit permits the use of XPI GETMAIN and FREEMAIN calls, we recommend that you use the EXEC CICS GETMAIN and FREEMAIN commands instead.

### API and SPI commands

All can be used, except for:  
EXEC CICS SHUTDOWN  
EXEC CICS XCTL

**Note:** Take care when issuing recursive commands. For example, you must avoid entering a loop when issuing a transient data request from the XTDEREQ exit. Use of the recursion counter UEPRECUR is recommended.

## Exit XTDEREQC

### When invoked

After a transient data API request has completed, and before return from the transient data EXEC interface program.

### Exit-specific parameters

#### UEPCLPS

Address of the command-level parameter structure. See “The UEPCLPS exit-specific parameter” on page 240.

#### UEPTDOK

Address of the 4 byte token to be passed to XTDEREQC. This allows you, for example, to pass a work area to exit XTDEREQC.

#### UEPRCODE

Address of a 6-byte hexadecimal copy of the EIB return code ‘EIBRCODE’. For details of EIB return codes, refer to EIB fields, in the *CICS Application Programming Reference* manual.

#### UEPRESP

Address of a 4-byte binary copy of the EIB response code ‘EIBRESP’.

#### UEPRESP2

Address of a 4-byte binary copy of the EIB response code ‘EIBRESP2’.

#### UEPTSTOK

Address of a 4-byte token that is valid throughout the life of a task. See “Use of the task token UEPTSTOK” on page 243.

#### UEPRECUR

Address of a halfword recursion counter. The counter is set to 0 when the exit is first invoked, and is incremented for each recursive call.

#### UEPRSRCE

Address of an 8-character copy of the EIB resource value, EIBRSRCE.

#### UEP\_TD\_REMOTE\_SYSTEM

If the request is to be sent to a remote region, is the address of an area containing the 4-byte name of the remote region. (The remote region may have been specified by, for example, the SYSID option of the command, function shipping, or the REMOTESYSTEM option of the TDQUEUE definition.)

If the request is to be executed on the local region, this parameter is the address of a 4-byte area containing blanks.

#### UEP\_TD\_REMOTE\_NAME

If the request is to be sent to a remote region, is the address of an area containing the 4-character name by which the queue is known in the remote region.

### Return codes

## UERCNORM

Continue processing.

## UERC PURG

Task purged during XPI call.

### XPI calls

All can be used.

Although the exit permits the use of XPI GETMAIN and FREEMAIN calls, we recommend that you use the EXEC CICS GETMAIN and FREEMAIN commands instead.

### API and SPI commands

All can be used, except for:  
EXEC CICS SHUTDOWN  
EXEC CICS XCTL

**Note:** Take care when issuing recursive commands. For example, you must avoid entering a loop when issuing a transient data request from the XTDEREQC exit. Use of the recursion counter UEPRECUR is recommended.

## The command-level parameter structure

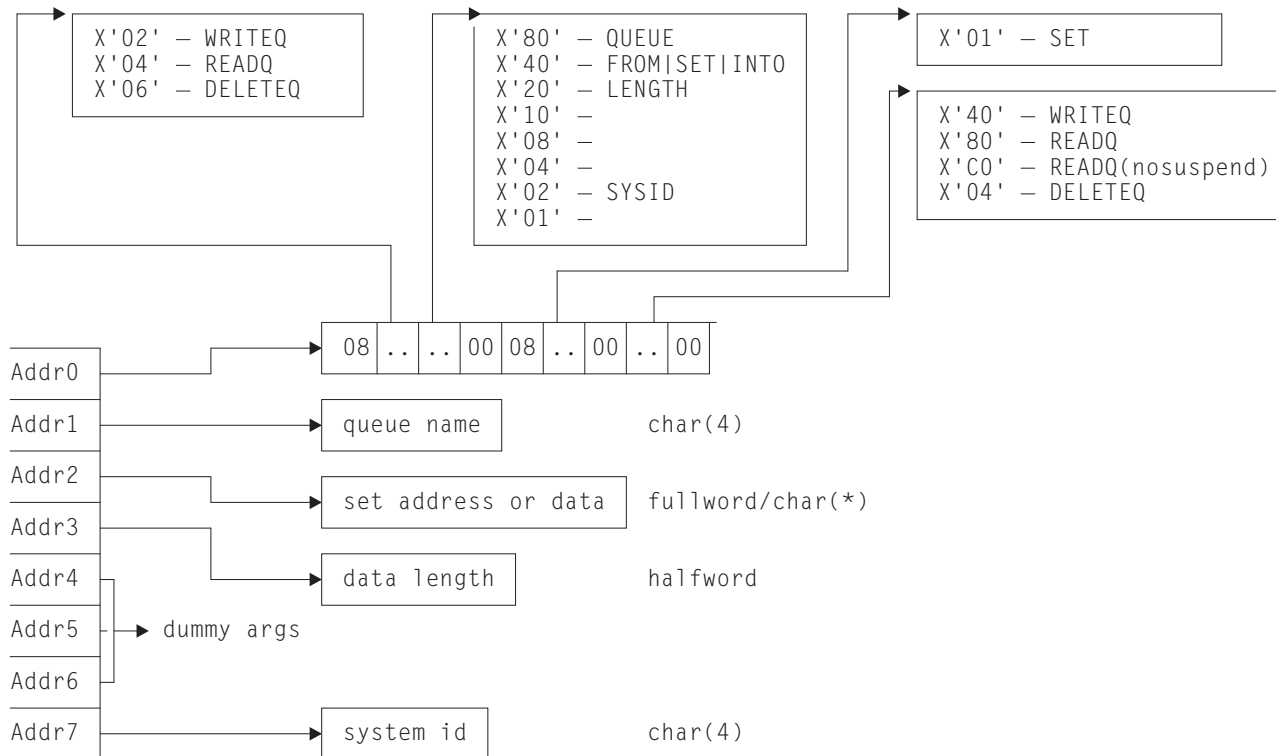

Figure 3. The command-level parameter structure for transient data

The command-level parameter structure consists of a series of addresses. The first address points to the EXEC interface descriptor (EID), which consists of an 8-byte area that describes the type of request and identifies each keyword specified with the request. The remaining addresses point to pieces of data associated with the request. (For example, the second address points to the queue name.)

You can examine the EID to determine the type of request and the keywords specified. You can examine the other parameters in the list to determine the values of the keywords. You can also modify values of keywords specified on the request. (For example, you could change the sysid specified in the request.)

### **End of parameter list indicator**

The high-order bit is set on in the last address set in the parameter list to indicate that it is the last one in the list. On return from your user exit program, CICS scans the parameter list for the high-order bit to find the last parameter. Therefore, if you modify the length of the parameter list, you must also reset the high-order bit to indicate which is the new last address.

For example, if the parameter list specifies only the first two addresses (TD\_ADDR0, the address of the EID, and TD\_ADDR1, the address of the name of the queue named in a DELETEQ request), the high-order bit is set on in TD\_ADDR1. If you extend the parameter list by setting the address of a SYSID in TD\_ADDR7, you must reset the high-order bit in TD\_ADDR1 and set it on in TD\_ADDR7 instead.

The maximum size of parameter list is supplied to the exit, thus allowing your exit program to add any parameters not already specified without needing to first obtain more storage.

The original parameter list, as it was before XTDEREQ was invoked, is restored after the completion of XTDEREQC. It follows that the execution diagnostic facility (EDF) displays the original command before **and** after execution. **EDF does not display any changes made by the exit.**

#### ***The UEPCLPS exit-specific parameter:***

The UEPCLPS exit-specific parameter is included in both exit XTDEREQ and exit XTDEREQC. It is the address of the command-level parameter structure. The command-level parameter structure contains 8 addresses, TD\_ADDR0 through TD\_ADDR7. It is defined in the DSECT TD\_ADDR\_LIST, which you should copy into your exit program by including the statement COPY DFHTDUED.

The command-level parameter list is made up as follows:

#### **TD\_ADDR0**

is the address of an 8-byte area called the EID, which is made up as follows:

- **TD\_GROUP**
- **TD\_FUNCT**
- **TD\_BITS1**
- **TD\_BITS2**
- **TD\_EIDOPT5**
- **TD\_EIDOPT6**
- **TD\_EIDOPT7**

#### **TD\_GROUP**

Always X'08', indicating that this is a transient data request.

#### **TD\_FUNCT**

One byte that defines the type of request:

**X'02'** WRITEQ

X'04' READQ  
X'06' DELETEQ.

#### TD\_BITS1

Existence bits that define which arguments were specified. To obtain the argument associated with a keyword, you need to use the appropriate address from the command-level parameter structure. Before using this address, you must check the associated existence bit. If the existence bit is set off, the argument was not specified in the request and the address should not be used.

X'80' Set if the request contains an argument for the QUEUE keyword. If set, **TD\_ADDR1** is meaningful.

X'40' Set if the request contains an argument for any of the INTO, SET, or FROM keywords. If set, **TD\_ADDR2** is meaningful.

X'20' Set if the request contains an argument for the LENGTH keyword. If set, **TD\_ADDR3** is meaningful.

X'02' Set if the request contains an argument for the SYSID keyword. If set, **TD\_ADDR7** is meaningful.

#### TD\_BITS2

Two bytes not used by transient data.

#### TD\_EIDOPT5

Indicates whether certain keywords were specified on the request.

X'01' SET (and not INTO) was specified.

#### TD\_EIDOPT6

One byte not used by transient data.

#### TD\_EIDOPT7

Indicates whether certain functions and/or keywords were specified on the request:

X'40' WRITEQ specified

X'80' READQ specified

X'C0' READQ(nosuspend) specified

X'04' DELETEQ specified.

#### TD\_ADDR1

is the address of a 4-byte area containing the name from QUEUE.

#### TD\_ADDR2

is the address of one of the following:

- A 4-byte address from SET (if the request is READQ and **TD\_EIDOPT5** indicates that this is SET).
- Data from INTO (if the request is READQ and **TD\_EIDOPT5** indicates that this is not SET). You cannot modify this bit in your user exit.
- Data from FROM (if the request is WRITEQ).

#### TD\_ADDR3

is the address of one of the following:

- The halfword value of LENGTH (if the request is READQ or WRITEQ).  
**Warning:** For requests that specify INTO, do not change the value of LENGTH to a value greater than that specified by the application. To do so causes a storage overlay in the application.

**TD\_ADDR4**

is the address of a value intended for CICS internal use only. It must not be used.

**TD\_ADDR5**

is the address of a value intended for CICS internal use only. It must not be used.

**TD\_ADDR6**

is the address of a value intended for CICS internal use only. It must not be used.

**TD\_ADDR7**

is the address of an area containing the value of SYSID.

**TD\_ADDR8**

is the address of a value intended for CICS internal use only. It must not be used.

**Modifying fields in the command-level parameter structure:** Some fields that are passed to transient data are used as input to the request, some are used as output fields, and some are used for both input and output. The method your user exit program uses to modify a field depends on the usage of the field.

The following are always input fields:

- QUEUE
- FROM
- SYSID

The following are always output fields:

- INTO
- SET

LENGTH is an input field on a WRITEQ request, and an output field on a READQ request that specifies SET. It is both an input and an output field on a READQ request that specifies INTO.

**Modifying input fields:** The correct method of modifying an input field is to create a new copy of it, and to change the address in the command-level parameter list to point to your new data.

**Note:** You must never modify an input field by altering the data that is pointed to by the command-level parameter list. To do so would corrupt storage belonging to the application program and would cause a failure when the program attempted to reuse the field.

**Modifying output fields:** The technique described in “Modifying input fields” is not suitable for modifying output fields. (The results would be returned to the new area instead of the application’s area, and would be invisible to the application.)

An output field is modified by altering the data that is pointed to by the command-level parameter list. In the case of an output field, you can modify the application’s data in place, because the application is expecting the field to be modified.



**Modifying fields used for both input and output:** An example of a field that is used for both input and output is LENGTH on a READQ request that specifies INTO. You can treat such fields in the same way as output fields, and they are considered to be the same.

**Modifying the EID:** It is not possible to modify the EID to make major changes to requests, such as changing a READQ request to a WRITEQ request.

However, you can make minor changes to requests, such as turning on the existence bit for SYSID so that the request can be changed into one that is shipped to a remote system.

The list that follows shows the bits in the EID that **can** be modified. Any attempt to modify any other part of the EID is ignored.

**TD\_BITS1**

**X'20'** The existence bit for LENGTH.

**X'02'** The existence bit for SYSID.

**TD\_EIDOPT5**

**X'01'** Existence bit for SET keyword. You cannot modify this bit from your user exit.

**TD\_EIDOPT7**

Changes to TD\_EIDOPT7 are limited to READQ requests. X'80'-READQ is interchangeable with X'C0'-READQ(nosuspend). No other changes may be made to this byte.

The EID is reset to its original value before return to the application program. That is, changes made to the EID are retained for the duration of the transient data request only.

**Note:** Your user exit program is prevented from making major changes to the EID. However, you must take great care when making the minor modifications that **are** permitted.

**Use of the task token UEPTSTOK:** UEPTSTOK provides the address of a 4-byte area that you can use to pass information between successive transient data requests in the same task. (By contrast, UEPTDTOK is usable only for the duration of a single transient data request, because its contents may be destroyed at the end of the request.) For example, if you need to pass information between successive invocations of the XTDEREQ exit, UEPTSTOK provides a means of doing this.

**The EIB:**

Copies of EIBRSRCE, EIBRCODE, EIBRESP, and EIBRESP2 are passed to the exit, so that you can:

- Modify or set completion and resource information in XTDEREQ and XTDEREQC
- Examine completion and resource information in XTDEREQC.

You can update the copies of EIBRSRCE, EIBRCODE, EIBRESP, and EIBRESP2 that you are given in the parameter list. Transient data copies your values into the real EIB after the completion of XTDEREQC; or if you specify a return code of 'bypass' in XTDEREQ.

You must set valid transient data responses. You must set all three of EIBRCODE, EIBRESP, and EIBRESP2 to a consistent set of values, such as would be set by CICS transient data to describe a valid completion. **CICS does not police the consistency of EIBRCODE, EIBRESP, and EIBRESP2.** However, if EIBRCODE is set to a non-zero value and EIBRESP is set to zero then CICS will override EIBRESP with a non-zero value. To aid you in setting the values of EIBRCODE, EIBRESP, and EIBRESP2, the values used by transient data are specified in DFHTDUED.

## User log record recovery program exits XRCINIT and XRCINPT

At warm and emergency restart, updates made to recoverable CICS resources that were not committed when the system terminated must be backed out. XRCINIT and XRCINPT are invoked from the user log record recovery program, which is used to back out, where necessary, user-written system log entries.

XRCINIT is invoked at warm and emergency restart:

- Before the first user recovery record is delivered to XRCINPT
- When all such records have been delivered to XRCINPT.

XRCINPT is invoked whenever a user log record is read from the system log.

You can use XRCINPT to change the default actions taken by CICS at emergency restart for particular user-journaled records. Records passed to XRCINPT are those in UOWs that:

- Appeared in the last complete activity keypoint
- Were in flight when CICS terminated
- Committed, backed out, or went in-doubt after the start of the last complete activity keypoint. (However, this only applies to those records for which the leftmost bit of the JTYPEID specified in the WRITE JOURNALNAME(DFHLOG) request was a one.)

Records written by the activity keypoint exit XAKUSER are passed only if they appear in the last complete activity keypoint. They are passed after all other records. The order of presentation of records may therefore be different from their order in the reverse log stream sequence.

The format of records passed to the exit is:

### Offset Field contents

0	JTYPEID
2	Reserved
4	Length of prefix data (L). (Zero if no prefix)
8	Prefix data (if any)
8 + L	Log data

The record is mapped by the DSECT CL\_USER\_HEADER in copybook DFHLGGFD.

When using XRCINIT and XRCINPT, you should bear in mind that the exits may be invoked before recovery of temporary storage and transient data resources is complete.

For further guidance information about exits for unit of work backout, refer to the *CICS Recovery and Restart Guide*.

### **Coding the exit programs**

CICS services can be used in exit programs invoked from these exits using the XPI or EXEC CICS commands. However, you need to consider the following:

- There is a restriction on using the XPI early during initialization: do not invoke exit programs that use the XPI functions TRANSACTION\_DUMP, WRITE\_JOURNAL\_DATA, MONITOR and INQUIRE\_MONITOR\_DATA until the second phase of the PLTPI.
- There are also restrictions on the use of EXEC CICS commands in these exits:
  - You cannot use EXEC CICS commands to access terminal control services.
  - You are strongly advised not to use temporary storage, transient data, file control, journal control, or DL/I services, because the resources that you try to access may also be in a state of recovery and therefore “not open for business”. Attempting to access resources in these circumstances causes, at best, serialization of the recovery tasks and, at worst, a deadlock.

If you do issue file control requests in programs invoked from these exits, note that:

- If an exit program acquires an area as a result of a file control request, it is the responsibility of the program to release that area.
  - An exit program must not attempt to make any file control requests to a file referring to a VSAM data set with a string number of 1, unless no action is specified for that file during the initialization exit.
  - Your exit program must not issue EXEC CICS commands if the recovery is as the result of an EXEC CICS SYNCPOINT ROLLBACK request.
  - Exit programs that issue EXEC CICS commands must first address the EIB. See “Using CICS services” on page 4.
  - Exit programs that issue EXEC CICS commands, and that use the DFHEIENT macro, should use the DFHEIRET macro to set a return code and return to CICS. See “Returning values to CICS” on page 10.
  - Exit programs invoked from these exits must be translated with the NOEDF option, if they issue EXEC CICS commands. See “EDF and global user exits” on page 6.
- Task-chained storage acquired in an exit program is released at the completion of emergency restart processing. However, the exit program should attempt to release the storage as soon as its contents are no longer needed.
  - No exit program should reset either the absent or no-action indicators set by the file control backout program.
  - Take care when issuing recursive commands not to cause a loop. For example, it is your responsibility to avoid entering a loop when an RC request is issued from these exits.

### **Enabling the exit programs**

To enable these exits, you must do one of the following:

- Specify the system initialization parameter TBEXITS=(name1,name2,name3,name4,name5,name6), where name1 through

name6 are the names of your user exit programs for XRCINIT, XRCINPT, XFCBFAIL, XFCLDEL, XFCBOVER, and XFCBOUT.

- Enable the exits during the first stage of initialization using a PLTPI program.

If you use the TBEXITS parameter to enable the exits, a global work area of 4 bytes is provided. If you use a PLTPI program, you can select the size of the global work area. You can also enable more than one exit program for use at each exit point; the TBEXITS parameter allows only one exit program at each exit point. PLTPI processing is described in Chapter 4, “Writing initialization and shutdown programs,” on page 425.

## Exit XRCINIT

### When invoked

At warm and emergency restart:

- Before the first user recovery record is delivered to XRCINPT
- When all such records have been delivered to XRCINPT.

### Exit-specific parameters

#### UEPTREQ

Address of a 1-byte flag indicating the reason for the call. When UEPTREQ has a value of UEUSINIT, the exit has been invoked at the start of user recovery, and when UEPTREQ has a value of UEUSTERM, the exit has been invoked at the end of user recovery.

#### UEPRSTRT

Address of a 1-byte flag that indicates how CICS was restarted:

#### UEPRWARM

Warm start

#### UEPREMER

Emergency start.

### Return codes

#### UERCNORM

Continue processing. No other return codes are supported.

### XPI calls

All can be used. See page “User log record recovery program exits XRCINIT and XRCINPT” on page 244 for restrictions.

## Exit XRCINPT

### When invoked

At warm and emergency restart, once for each user log record found in the system log.

### Exit-specific parameters

#### UEPUOWST

Address of a 1-byte flag indicating the disposition of the UOW. The possible values are:

#### UEPUOWAK

Activity keypoint record

#### UEPUOWCM

UOW committed

**UEPUOWBO**

UOW backed out

**UEPUOWIF**

UOW was in-flight

**UEPUOWID**

UOW was in-doubt.

**UEPLGREC**

Address of the log record just read. The journal control record can be mapped using the information supplied in Chapter 27, "CICS logging and journaling," on page 709.

**UEPLGLEN**

Address of a fullword containing the length of the log record.

**UEPTAID**

Address of a 4-byte field containing the task identifier.

**UEPTRID**

Address of a 4-byte field containing the transaction identifier.

**UEPTEID**

Address of a 4-byte field containing the terminal identifier.

**Note:** The values of the fields addressed by UEPTAID, UEPTRID, and UEPTEID are meaningless for activity keypoint records (that is, if the field addressed by UEPUOWST contains UEPUOWAK).

**Return codes****UERCNORM**

Continue processing.

**UERCBYBYP**

Bypass this record.

**XPI calls**

All can be used. See page "User log record recovery program exits XRCINIT and XRCINPT" on page 244 for restrictions.

**VTAM terminal management program exit XZCATT****Exit XZCATT****When invoked**

Before task attach for terminal tasks.

**Exit-specific parameters****UEPTCTTE**

Address of the terminal control table terminal entry (TCTTE). The TCTTE can be mapped using the DSECT DFHTCTTE.

**UEPTIOA**

Address of the terminal input/output area (TIOA). The TIOA can be mapped using the DSECT DFHTIOA. However, fields TIOASAL and TIOASCA are **not** programming interfaces.

**UEPTPN**

Address of the APPC transaction process name (TPN), or the LU6.1 process name (DPN), whose length is addressed by the parameter UEPTPNL.

**UEPTPNL**

Address of a 1-byte field containing the length of the TPN or DPN.

**UEPTRAN**

Address of the 4-byte transaction ID.

**Note:** The exit program must not change the TRANSID of tasks started by automatic transaction initiation (ATI). (This is because CICS needs to match the TRANSID in its program control table with the TRANSID in the automatic initiate descriptor (AID) that was created in the AOR.)

**Return codes****UERCNORM**

Continue processing.

**XPI calls**

All can be used.

## VTAM working-set module exits XZCIN, XZCOUT, XZCOUT1, and XZIQUE

**Note:** None of the exits in the VTAM working-set module is available for advanced program-to-program communication (APPC, or LUTYPE6.2) links.

**Exit XZCIN****When invoked**

After an input event.

**Exit-specific parameters****UEPTCTTE**

Address of the terminal control table terminal entry (TCTTE). The TCTTE can be mapped using the DSECT DFHTCTTE.

**UEPTIOA**

Address of the terminal input/output area (TIOA). Your exit program should not change the address. The TIOA can be mapped using the DSECT DFHTIOA. However, fields TIOASAL and TIOASCA are **not** programming interfaces.

**Return codes****UERCNORM**

Continue processing.

**XPI calls**

All can be used. However, we do not recommend that you use a GETMAIN call to obtain terminal-class storage for use as a replacement TIOA. This is because there are several internal pointers to the TIOA, and if any one of these is not updated the application may experience problems.

**Exit XZCOUT****When invoked**

Before an output event.

**Exit-specific parameters**

### **UEPTCTTE**

Address of the terminal control table terminal entry (TCTTE). The TCTTE can be mapped using the DSECT DFHTCTTE.

### **UEPTIOA**

Address of the terminal input/output area (TIOA). Your exit program should not change the address. The TIOA can be mapped using the DSECT DFHTIOA. However, fields TIOASAL and TIOASCA are **not** programming interfaces.

**Note:** In certain circumstances—for example, when XZCOUT is invoked before the send of a NULL RU—UEPTIOA contains zeroes.

### **Return codes**

#### **UERCNORM**

Continue processing.

### **XPI calls**

All can be used. However, we do not recommend that you use a GETMAIN call to obtain terminal-class storage for use as a replacement TIOA. This is because there are several internal pointers to the TIOA, and if any one of these is not updated the application may experience problems.

## **Exit XZCOUT1**

### **When invoked**

Before a message is broken into RUs.

### **Exit-specific parameters**

#### **UEPTCTTE**

Address of the terminal control table terminal entry (TCTTE). The TCTTE can be mapped using the DSECT DFHTCTTE.

#### **UEPTIOA**

Address of the terminal input/output area (TIOA). Your exit program should not change the address. The TIOA can be mapped using the DSECT DFHTIOA. However, fields TIOASAL and TIOASCA are **not** programming interfaces.

### **Return codes**

#### **UERCNORM**

Continue processing.

### **XPI calls**

All can be used. However, we do not recommend that you use a GETMAIN call to obtain terminal-class storage for use as a replacement TIOA. This is because there are several internal pointers to the TIOA, and if any one of these is not updated the application may experience problems.

## **XZIQUE exit for managing MRO and APPC intersystem queues**

You can use the XZIQUE exit to control the number of queued requests for sessions on MRO and APPC connections.

### **Note:**

- Queued requests for sessions are known as “*allocate queues*”.

- The equivalent global user exit to control the number of queued requests for sessions on IP interconnectivity (IPIC) connections is XISQUE: see “XISQUE exit for managing IPIC intersystem queues” on page 258.
- There are several methods that you can use to control the length of intersystem queues. For a description of the various methods, see Intersystem session queue management, in the *CICS Intercommunication Guide*.

The XZIQUE exit enables you detect queuing problems (bottlenecks) early. It extends the function provided by the XISCONA global user exit (introduced in CICS/ESA 3.3 and described on page “Intersystem communication program exits XISCONA and XISLCLQ” on page 138), which is invoked only for function shipping and DPL requests. XZIQUE is invoked for transaction routing, asynchronous processing, and distributed transaction processing requests, as well as for function shipping and DPL. Compared with XISCONA, it receives more detailed information on which to base its decisions.

XZIQUE enables allocate requests to be queued or rejected, depending on the length of the queue. It also allows a connection on which there is a bottleneck to be terminated and then re-established.

**Interaction with the XISCONA exit:** There is no interaction between the XZIQUE and XISCONA global user exits. If you enable both exits, XISCONA and XZIQUE could both be invoked for function shipping and DPL requests, which is not recommended. You should ensure that only one of these exits is enabled. Because of it provides more function and greater flexibility, it is recommended that you use XZIQUE rather than XISCONA.

If you already have an XISCONA global user exit program, you could possibly modify it for use at the XZIQUE exit point.

**When the XZIQUE exit is invoked:**

The XZIQUE global user exit is invoked, if it is enabled, at the following times:

- Whenever CICS tries to acquire a session with a remote system and there is no free session available. It is invoked whether or not you have specified the QUEUELIMIT option on the CONNECTION definition, and whether or not the limit has been exceeded. It is not invoked if the allocate request specifies NOQUEUE or NOSUSPEND.  
Requests for sessions can arise in a number of ways, such as explicit EXEC CICS ALLOCATE commands issued by DTP programs, or by transaction routing or function shipping requests.
- Whenever an allocate request succeeds in finding a free session, after the queue on the connection has been purged by a previous invocation of the exit program. In this case, your exit program can indicate that CICS is to continue processing normally, resuming queuing when necessary.

**Using an XZIQUE global user exit program:** When the exit is enabled, your XZIQUE global user exit program is able to check on the state of the allocate queue for a particular connection in the local system. Information is passed to the exit program in a parameter list, that is structured to provide data about non-specific allocate requests, or requests for specific modegroups, depending on the session request. Non-specific allocate requests are for MRO, LU6.1, and APPC sessions that do not specify a modegroup.



Using the information passed in the parameter list, your global user exit program can decide (based on queue length, for example) whether CICS is to queue the allocate request. Your program communicates its decision to CICS by means of one of the return codes CICS provides. These are:

#### **UERCAQUE**

This return code indicates that CICS is to queue the allocate request.

The total number of allocate requests queued against the connection is provided in field A14ESTAQ of the system entry statistics (for all non-specific allocates) or A20ESTAQ of the mode entry statistics (for specific modegroup allocates). See DSECTs DFHA14DS or DFHA20DS for details. CICS passes to the exit program, in the exit specific parameter UEPQUELIM, the QUEUELIMIT parameter from the connection definition.

If the limit has not been reached, you can return control to CICS with return code UERCAQUE.

#### **UERCAPUR**

This return code indicates that CICS is to reject the allocate request and return SYSIDERR to the application program, but leave the existing queue unchanged.

If the number of queued allocate requests has reached the limit set on the QUEUELIMIT parameter for the connection, you can request that CICS rejects the request. However, you should first check whether the state of the link is satisfactory. This means checking that the rate of allocation of sessions is acceptable. Use the time the queue was started, the current time, and the total number of allocates processed since the queue began, to determine the rate at which CICS is processing requests. The relevant fields are: UEPSAQTS and UEPSACNT for non-specific allocate requests; and UEPMAQTS and UEPMACNT for specific modegroup requests.

To determine whether CICS is allocating requests for sessions on this connection at an acceptable rate, you can compare the calculated time with either of the following:

1. The parameter from the connection definition, MAXQTIME, which is passed in the exit specific parameter UEPQMXQT
2. Some other preset time value.

If the processing time using this kind of formula is acceptable, return control to CICS with return code UERCAPUR to purge only this request.

#### **UERCALL or UERCALLM**

These return codes indicate that you want CICS to deal with the request as follows:

- UERCALL—reject this request, purge all other queued allocate requests on this connection, and send an information message to the operator console.
- UERCALLM—reject this request, purge all other queued modegroup allocate requests on this connection, and send an information message to the operator console.

If the queue limit has been reached but the performance of allocate processing against the queue is below the acceptable limits defined in your user exit program, you can return control to CICS as follows:

- For non-specific allocate requests, use return code UERCALL. UERCALL also returns SYSIDERR to all application programs waiting on the purged allocate requests. CICS sets the UEPFLAG parameter to UEPRC8 on subsequent calls to your XZIQUE exit program to indicate that UERCALL was returned previously to purge the queue.

- For specific modegroup allocate requests, use return code UERCAKLM. UERCAKLM also returns SYSIDERR to all application programs waiting on the purged allocate requests. CICS sets the UEPFLAG parameter to UEPRC12 on subsequent calls to your XZIQUE exit program to indicate that UERCAKLM was returned previously to purge the queue.

Purging a queue that is causing congestion in the flow of tasks frees task slots that are needed to prevent the system becoming clogged. The more you allow a session queue to grow, the more likely you are to reach the task ceiling set by the MAXT parameter, and then cause a queue of incoming tasks in the local region that cannot be attached. Note that some internal CICS requests (such as those for the LU services model transactions CLS1, CLS2, and CLS3) are not purged by return codes UERCAKLL and UERCAKLM.

If a queue has been purged previously (with UERCAKLL or UERCAKLM) but there are no queued requests currently, check the number of successful allocates since the queue was last purged. For non-specific allocate requests, this number is in UEPSARC8, and for specific modegroup requests, this number is in UEPMAR12. If no requests of this type have been allocated on this connection since the queue was last purged, the problem that caused the purge previously has not been resolved, and this request should be rejected with UERCAPUR.

If the UEPSARC8 or UEPMAR12 parameters show that allocates are being processed, you should use UERCAQUE to resume queuing of requests. If you return with UERCAQUE in this case, CICS issues an information message to the console to signal that queuing has been resumed.

**Note:** The address of the system entry statistics record, UEPCONST, is supplied for both non-specific and specific modegroup allocate requests.

The address of the modegroup statistics record, UEPMODST, is set to zeros for non-specific allocate requests. This address is supplied only if the request is for a specific modegroup.

If the exit is invoked after a successful allocate following the suppression of queuing, you can use the following return code:

**UERCNORM**

This return code indicates that CICS is to resume normal processing on the link, including queuing of requests.

***Statistics fields in DFHA14DS and DFHA20DS:***

There are some statistics fields that your XZIQUE global user exit program can use to control queues.

***A14EALRJ:***

Each time an XZIQUE global user exit program returns with a request to reject a request, CICS increments a new field in the system entry connection statistics. This is A14EALRJ (allocate rejected) in DSECT DFHA14DS. This field is provided to help you to tune the queue limit. Normally, if the number of sessions and the queue limit defined for a link are correctly balanced, and there has been no abnormal congestion on the link, the A14EALRJ should be zero. If the rejected allocates field is non-zero it probably indicates that some action is needed.

***A14EQPCT and A20EQPCT:***

Each time an XZIQUE global user exit program returns with a request to purge a queue, CICS increments a new field in either the system entry or mode entry connection statistics. These fields are:

**A14EQPCT**

The count of the number of times the queue has been purged for the connection as a whole.

**A20EQPCT**

The count of the number of times the mode group queue has been purged.

For detailed information about statistics fields, what they contain and how they are updated, see ISC/IRC system entry: Resource statistics, in the *CICS Performance Guide*.

**Exit XZIQUE:**

**When invoked**

Whenever:

1. An allocate request for a session is about to be queued
2. An allocate request succeeds following previous suppression of queuing.

**Exit-specific parameters**

**UEPZDATA**

Address of the 70-byte area containing the information listed below. This area is mapped by the DSECT in copybook DFHXZIDS.

**Area addressed by UEPZDATA**

**UEPSYSID**

The 4-byte SYSID of the connection.

**UEPREQ**

A 2-byte origin-of-request code, which can have the following values:

- TR** Transaction routing
- FS** Function shipping (includes distributed program link)
- AL** Other kinds of intercommunication (for example, distributed transaction processing (DTP) or CPI Communications).

**UEPREQTR**

The 4-byte identifier of the requesting transaction (applicable only when the origin-of-request code is FS or AL).

**UEPTRAN**

The 4-byte identifier of the transaction being routed (applicable only when origin of request is TR).

**UEPFLAG**

A 1-byte flag indicating whether a return code 8 or return code 12 was issued last time the exit was invoked.

**UEPRC8**

The exit program returned control to CICS on the previous invocation with return code 8.

**UEPRC12**

The exit program returned control to CICS on the previous invocation with return code 12.

**UEPPAD**

A 1-byte padding field.

**UEPFSPL**

Address of the 10-byte function shipping parameter list.

**UEPCONST**

Address of the 158-byte system entry statistics record (this can be mapped using DSECT DFHA14DS).

**UEPMDST**

Address of the 84-byte modegroup statistics record for the modegroup specified in the relevant CICS profile. This field applies only to APPC connections for a specific allocate. For LU61, IRC, or non-specific APPC allocates, it contains zero.

The statistics record can be mapped using DSECT DFHA20DS. The modegroup name field (A20MODE) may contain blanks. The record is followed by a fullword of X'FFFFFFFF'.

**UEPSTEX**

A 6-byte area containing additional current statistics for APPC that are not already in the modegroup statistics record (DFHA20DS). For specific allocates, the numbers refer to the specified modegroup only. For non-specific allocates, they refer to the whole connection—that is, they are the totals of each modegroup.

The 6-byte area contains:

**UEPEBND**

A halfword binary field containing the number of bound sessions

**UEPEWWT**

A halfword binary field containing the number of contention winners with tasks

**UEPELWT**

A halfword binary field containing the number of contention losers with tasks.

**UEPEMXQT**

A halfword binary field containing the maximum queuing time specified for the connection (MAXQTIME on the CONNECTION resource definition).

**UEPMDGST**

Address of a set of 84-byte modegroup statistics records—one for each user modegroup for the connection. This field applies only to APPC connections for a non-specific allocate. For LU61, IRC, and APPC specific allocates, it contains zero.

Each statistics record can be mapped using DSECT DFHA20DS. The modegroup name field (A20MODE) may contain blanks. The end of the set of records is indicated by a fullword of X'FFFFFFFF'.

**Non-specific allocates data:**The following three fields contain data relating to MRO, LU6.1, and non-specific APPC allocates:

**UEPSAQTS**

A double-word binary field containing the time stamp from the TCT system entry indicating the time the queue of non-specific requests was started.

**UEPSACNT**

A half-word binary field containing the number of all non-specific allocates processed since the queue was started (see UEPSAQTS for the start time).

**UEPSARC8**

A half-word binary field containing the number of sessions freed since the queue was last purged as a result of a UEPCAKLL return code to CICS.

**Specific allocates data:**The following three fields contain data relating to specific modegroup allocates. They are applicable only when UEPMODST is non-zero (that is, it contains the address of the relevant modegroup statistics).

**UEPMAQTS**

A double-word binary field containing the time stamp from the TCT mode entry indicating the time that the modegroup queue was started for this specific modegroup.

**UEPMACNT**

A half-word binary field containing the number of all specific allocates for this modegroup processed since the queue was started (see UEPMAQTS for the start time).

**UEPMAR12**

A half-word binary field containing the number of modegroup sessions freed since the queue was last purged as a result of a UEPCAKLL return code to CICS.

**UEPQUELM**

A half-word binary field containing the queue limit specified for this connection (QUEUELIMIT on the CONNECTION definition).

**Return codes**

In the case of an allocate that is about to be queued, use one of the following:

**UERCAQUE**

Queue the allocate request.

**UERCAPUR**

Reject the allocate request with SYSIDERR.

**UERCAKLL**

Reject this allocate request with SYSIDERR. Purge all other queued allocate requests and send an information message to the operator console. CICS also returns SYSIDERR to all application programs waiting on the purged allocate requests.

**UERCAKLM**

Reject this allocate request for the modegroup and return SYSIDERR. Purge all other queued allocate requests for the modegroup specified on this allocate request and send an information message to the operator console. Retry the modegroup after an interval.

**UERCPURG**

Task purged during XPI call.

In the case of a successful allocate following the use of UERCAKLL or UERCAKLM, on a previous invocation of the exit, use one of the following:

**UERCNORM**

Resume normal operation of the link or modegroup.

**UERCAPUR**

Reject the allocate request with SYSIDERR.

**XPI calls**

All can be used.

**Designing an XZIQUE global user exit program**

The functions of your XZIQUE exit should be designed:

1. To control of the number of tasks (and the amount of associated resource) that are waiting in a queue for a free intersystem session. Waiting tasks can degrade the performance of the local system.
2. To detect poor response from the receiving (remote) system and to notify the operator (or automatic operations program).
3. To cause CICS to issue a message when the link resumes normal operation.

The XZIQUE global user exit parameter list is designed to support these objectives.

**Related concepts**

“The MRO and APPC session queue management sample exit program” on page 24

**Design considerations:** The information passed at XZIQUE is designed to enable your XZIQUE global user exit program to:

- Avoid false diagnosis of problems on the connection by distinguishing poor response times from a complete bottleneck
- Ensure that a link resumes normal operation quickly and without operator intervention once any problem in a remote system is resolved.

**Some guidance on the use of IRC/ISC statistics:** CICS adds an entry for unsatisfied allocate requests to the following queues:

**Non-specific (generic) allocate queue**

All non-specific allocate requests are queued in this single queue. CICS makes the total number of entries in this queue available in the system entry statistics field A14ESTAQ, to which your global user exit program has access by means of the address of the system entry statistics, which is passed in UEPCONST.

**Specific modegroup allocate queues**

Specific allocate requests are queued in the appropriate modegroup queue—one queue for each specific modegroup name. CICS makes the total number of entries in all these queues available, as a single total, in the mode entry statistics field A20ESTAQ, to which your global user exit program has access by means of the address of the mode entry statistics, which is passed in UEPMODST.

**Sample exit program design:** A sample XZIQUE exit program is provided with CICS Transaction Server for z/OS, Version 3 Release 2 as a base for you to design your own global user exit program. It is called DFH\$XZIQ, and is supplied in the CICSTS32.CICS.SDFHSAMP library. The DSECT used by the sample program to map the area addressed by UEPZDATA is called DFHXZIDS, and this is supplied in the CICSTS32.CICS.SDFHMAC library.

As supplied, the sample exit program implements the same basic function as described for the QUEUELIMIT and MAXQTIME parameters on the connection resource definition. If the XZIQUE exit is not enabled, CICS uses these parameters

to control the existence and length of the queue of allocate requests. If you enable the exit, the parameters from the connection definition are passed to your XZIQUE global user exit program, which can change the way in which these parameters are used.

The exit program also demonstrates how to control allocate requests for a particular modegroup, based on the same QUEUELIMIT and MAXQTIME parameters.

*Overview of the sample exit program:* The program uses the exit-specific parameters passed by CICS to determine the state of the connection, and to request the appropriate action, as follows:

1. The connection is operating normally; a queue may exist, but is of short length. In this case, the exit program returns with UERCAQUE to indicate that CICS is to **queue the request**.
2. The response from the partner system is slower than the rate of requests demands, and the queue length has grown to the limit specified on the QUEUELIMIT parameter. The partner system is still operating normally, but is overloaded. In this case, the exit program returns with UERCAPUR to indicate that CICS is to **purge the request**.
3. The queue has reached the limit specified by the QUEUELIMIT parameter, **and** requests that join the queue are expected to take longer to be satisfied than the time defined by the MAXQTIME parameter. (The estimated time for a request to complete is calculated by dividing the number of successful requests since the queue first formed by the time elapsed since it formed. These statistics are passed to the exit in the parameter list.)  
These criteria are used to determine that the connection is not operating correctly, and that continued queuing of tasks is not helpful. In this case:
  - The exit returns with UERCAKLL requesting CICS to **purge all queued** user requests from the connection. The SYSIDERR condition is returned to the application program.
  - CICS issues message DFHZC2300 to warn that a connection is not performing as expected.
4. The queue has been purged as a result of a previous invocation of the global user exit program, there are still no free sessions, and the request is about to be queued. In this case, the exit program returns with UERCAPUR to indicate that CICS is to **purge the request**. This also leaves the UEPRC8 flag set.
5. The queue has been purged as a result of a previous invocation of the global user exit program. A new allocate request has been received and is about to be allocated because a session has become free. CICS invokes the exit program to enable it to indicate that normal processing can continue. In this case, the exit program returns with UERCNORM to indicate that CICS is to **continue processing normally**. This also causes the UEPRC8 flag to be unset following this invocation, and CICS to issue message DFHZC2301.

The sample program also monitors the length of queues for modegroup-specific allocate requests and controls these—in the same way as the queue for the whole connection—using the QUEUELIMIT parameter and MAXQTIME parameters.

If both UEPRC8 and UEPRC12 are set, UERCNORM is required twice to resume normal operation. The UEPRC8 condition is reset first in this case.

*Extensions to the sample program:* The sample exit program does not attempt to control the queue length, or detect poor response for a particular modegroup differently from the whole connection. This kind of enhancement is something you might want to add to your own exit program if your applications request specific modegroups via the allocate command (or via a transaction profile) and you think it would be useful to control the modegroups individually.

You can also use more complex decisions (such as adding time delays to lessen the risk of false diagnosis) to decide when to issue the return codes that purge the queue, and allow queuing to restart.

## XISQUE exit for managing IPIC intersystem queues

You can use the XISQUE exit to control the number of queued distributed program link (DPL) requests for sessions on IP interconnectivity (IPIC) connections.

### Note:

- Queued requests for sessions are known as “*allocate queues*”.
- IPIC connections are also known as “*IPCONN*s”.
- The equivalent global user exit to control the number of queued requests for sessions on MRO and APPC connections is XZIQUE: see “XZIQUE exit for managing MRO and APPC intersystem queues” on page 249.

The XISQUE exit enables you to detect queuing problems (bottlenecks) early. It is invoked only for DPL requests across IPCONN.

XISQUE enables allocate requests to be queued or rejected, depending on the length of the queue. It also allows an IPCONN on which there is a bottleneck to be terminated and then re-established.

### Related concepts

“The session queue management sample exit program, for IPIC connections” on page 24

## When the XISQUE exit is invoked

The XISQUE global user exit is invoked, if it is enabled, at the following times:

- Whenever CICS tries to acquire a session on an IPIC connection to a remote system and there is no free session available. It is invoked whether or not you have specified the QUEUELIMIT option on the IPCONN definition, and whether or not the limit has been exceeded.

Requests for IPIC sessions arise when DPL is used across an IPCONN.

- Whenever an allocate request succeeds in finding a free session, after the queue on the IPCONN has been purged by a previous invocation of the exit program. In this case, your exit program can indicate that CICS is to continue processing normally, resuming queuing when necessary.

## Exit XISQUE

### When invoked

When:

1. A DPL request for a session on an IPIC connection is about to be queued
2. An IPIC allocate request succeeds following previous suppression of queuing.



## Exit-specific parameters

### UEPISDATA

Address of the 78-byte area containing the information listed below. This area is mapped by the DSECT in copybook DFHXIQDS.

#### Area addressed by UEPISDATA:

### UEPREQ

A 2-byte origin-of-request code, which can have the following value:

**FS** Function shipping (includes distributed program link.)

### UEPIPCNM

The 8-byte name of the IPCONN.

### UEPREQTR

The 4-byte identifier of the requesting transaction.

### UEPFLAG

A 1-byte flag indicating whether a return code 8 was issued the last time the exit was invoked.

### UEPRC8

The exit program returned control to CICS on the previous invocation with return code 8.

### UEPFSPL

Address of the 10-byte parameter list for the DPL request.

### UEPCONST

Address of the 504-byte IPCONN statistics record (this can be mapped using DSECT DFHISRDS).

### UEPEMXQT

A halfword binary field containing the maximum queuing time specified for the IPCONN (the value of MAXQTIME on the IPCONN resource definition).

### UEPSAQTS

A double-word binary field containing the time stamp from the installed IPCONN resource definition, indicating the time the queue of allocate requests was started.

### UEPSACNT

A half-word binary field containing the number of allocate requests processed since the queue was started (see UEPSAQTS for the start time).

### UEPSARC8

A half-word binary field containing the number of sessions freed since the queue was last purged as the result of an UEPCAKLL return code.

### UEPQUELM

A half-word binary field containing the queue limit specified for this IPCONN (from the QUEUELIMIT option of the IPCONN definition).

## Return codes

In the case of an allocate that is about to be queued, use one of the following:

**UERCAQUE**

Queue the allocate request.

**UERCAPUR**

Reject the allocate request with SYSIDERR.

**UERCALL**

Reject this allocate request with SYSIDERR. Purge all other queued allocate requests and send an information message to the operator console. CICS also returns SYSIDERR to all application programs waiting on the purged allocate requests.

**UERPURG**

Task purged during XPI call.

In the case of a successful allocate following the use of UERCALL on a previous invocation of the exit, use one of the following:

**UERCNORM**

Resume normal operation of the IPCONN.

**UERCAPUR**

Reject the allocate request with SYSIDERR.

**XPI calls**

All can be used.

**Using an XISQUE global user exit program**

When the exit is enabled, your XISQUE global user exit program is able to check on the state of allocate queues for IPCONNs in the local system. The parameter list passed to the exit program on invocation provides data about a specific allocate request and IPCONN.

Using the information passed in the parameter list, your global user exit program can decide (based on queue length, for example) whether CICS is to queue the allocate request. Your program communicates its decision to CICS by setting one of the following return codes:

**UERCAQUE**

CICS is to queue the allocate request.

The total number of allocate requests currently queued against the connection is provided in field `ISR_CURRENT_QUEUED_ALLOCATES` of the IPCONN statistics record, which is addressed by the `UEPCONST` exit-specific parameter. See `DSECT DFHISRDS` for details.

CICS also passes to the exit program, in field `UEPQUELM`, the value of the `QUEUELIMIT` option of the IPCONN resource definition. If the queue limit has not been reached, you can return control to CICS with return code `UERCAQUE`.

**UERCAPUR**

CICS is to reject the allocate request, return `SYSIDERR` to the application program, and leave the existing queue unchanged.

If the number of queued allocate requests has reached the limit set on the `QUEUELIMIT` option of the IPCONN definition, you can request that CICS rejects the request. However, you should first check whether the state of the link is satisfactory. This means checking that the rate of allocation of sessions is acceptable. Use the time the queue was started, the current time, and the total

number of allocates processed since the queue began, to determine the rate at which CICS is processing requests. The relevant fields are: UEPSAQTS and UEPSACNT.

To determine whether CICS is allocating requests for sessions on this IPCONN at an acceptable rate, you can compare the calculated time with either of the following:

1. The value of the MAXQTIME option of the IPCONN resource definition, which is passed in the UEPEMXQT exit-specific parameter.
2. Some other preset time value.

If, using this kind of formula, you find the processing time to be acceptable, return control to CICS with return code UERCAPUR, which purges only this request.

#### **UERCALL**

Reject this request, purge all other allocate requests queued on this IPCONN, and send an information message to the operator console.

If the queue limit has been reached and the performance of allocate processing is below the acceptable limits defined in your user exit program, you can purge all queued allocate requests by specifying return code UERCALL.

UERCALL also causes CICS to:

- Return SYSIDERR to all application programs waiting on the purged allocate requests.
- On subsequent calls to your XISQUE exit program, set the UEPFLAG parameter to UEPRC8 to indicate that UERCALL was returned previously to purge the queue.

Purging a queue that is causing congestion in the flow of tasks frees task slots that are needed to prevent the system becoming clogged. The more you allow a session queue to grow, the more likely you are to reach the task ceiling set by the MAXT parameter, and then cause a queue of incoming tasks in the local region that cannot be attached.

If a queue has been purged previously (with UERCALL) but there are no queued requests currently, check the number of sessions freed since the queue was last purged. This number is in UEPSARC8. If no sessions have been freed on this IPCONN since the queue was last purged, the problem that caused the purge previously has not been resolved, and this request should be rejected with UERCAPUR.

If the UEPSARC8 parameter shows that sessions are being freed, you should use UERCAQUE to resume queuing of requests. If you return with UERCAQUE in this case, CICS issues an information message to the console to signal that queuing has been resumed.

#### **UERCNORM**

CICS is to resume normal processing on the connection, including queuing of requests.

Use UERCNORM when the exit is invoked after a successful allocate following the suppression of queuing.

### **Statistics fields in DFHISRDS**

The following fields in IPCONN statistics can help your XISQUE global user exit program to control allocate queues efficiently:

### **ISR\_XISQUE\_ALLOC\_REJECTS**

Each time an XISQUE global user exit program returns with a request to reject a request, CICS increments this field, which is provided to help you tune the queue limit. Normally, if the number of sessions and the queue limit specified on the IPCONN definition are correctly balanced, and there has been no abnormal congestion on the link, ISR\_XISQUE\_ALLOC\_REJECTS should be zero. If the rejected allocates field is non-zero it indicates that action is probably needed.

### **ISR\_XISQUE\_ALLOC\_QPURGES**

Each time an XISQUE global user exit program returns with a request to purge a queue, CICS increments this field.

For detailed information about the fields in IPCONN statistics, see “IPCONN statistics”, in the *CICS Performance Guide*. IPCONN statistics are mapped by DSECT DFHISRDS.

## **Designing an XISQUE global user exit program**

Your XISQUE exit program should be designed to:

1. Control of the number of tasks (and the amount of associated resource) that are waiting in a queue for a free IPIC session. Waiting tasks can degrade the performance of the local system.
2. Detect poor response from the remote system and notify the operator (or automatic operations program).
3. Cause CICS to issue a message when the IPCONN resumes normal operation.

The XISQUE parameter list is designed to support these objectives. The information it contains enables your exit program to:

- Avoid false diagnosis of connection problems by distinguishing poor response times from a complete bottleneck
- Ensure that a link resumes normal operation quickly and without operator intervention after a problem in a remote system is resolved

## **Using IPCONN statistics**

In reaching its decisions about which requests to reject, which to queue, and which queues to purge, your exit program will probably take into account the number of allocate requests currently queued against the connection. All allocate requests for a particular IPCONN are queued in a single queue that is specific to that IPCONN. CICS makes the total number of entries in this queue available in the IPCONN statistics field ISR\_CURRENT\_QUEUED\_ALLOCATES. Your exit program can access this field by means of the address of the IPCONN statistics, which is passed in the UEPCONST exit-specific parameter.

## **The sample exit program, DFH\$XISQ**

CICS provides a sample XISQUE exit program, DFH\$XISQ, that you can use as the basis for your own program. It is supplied in the CICSTS32.CICS.SDFHSAMP library. The DSECT used by the sample program to map the area addressed by UEPISTDATA is called DFHXIQDS, and is supplied in the CICSTS32.CICS.SDFHMAC library.

As supplied, the sample exit program implements the same basic function as described for the QUEUELIMIT and MAXQTIME parameters of the IPCONN resource definition. If the XISQUE exit is not enabled, CICS uses these parameters to control the existence and length of the queue of allocate requests. If you enable

the exit, the parameters from the IPCONN definition are passed to the XISQUE exit program, which can change the way in which these parameters are used.

#### Overview of the sample exit program

The program uses the exit-specific parameters passed by CICS to determine the state of the IPCONN, and to request the appropriate action, as follows:

1. The IPCONN is operating normally; a queue may exist, but is of short length.

In this case, the exit program returns with UERCAQUE to indicate that CICS is to queue the request.

2. The response from the partner system is slower than the rate of requests, and the queue length has grown to the limit specified on the QUEUELIMIT parameter. The partner system is still operating normally, but is overloaded.

In this case, the exit program returns with UERCAPUR to indicate that CICS is to purge the request.

3. The queue has reached the limit specified by the QUEUELIMIT parameter, and requests that join the queue are expected to take longer to be satisfied than the time defined by the MAXQTIME parameter. (The estimated time for a request to complete is calculated by dividing the number of successful requests since the queue first formed by the time elapsed since it formed. These statistics are passed to the exit in the parameter list.)

These criteria are used to determine that the connection is not operating correctly, and that continued queuing of tasks is not helpful. In this case:

- The exit returns with UERCAKLL, requesting CICS to purge all queued user requests from the connection. The SYSIDERR condition is returned to the application program.
- CICS issues message DFHZCaaaa to warn that a connection is not performing as expected.

4. The queue has been purged as a result of a previous invocation of the global user exit program, there are still no free sessions, and the request is about to be queued.

In this case, the exit program returns with UERCAPUR to indicate that CICS is to purge the request. This also leaves the UEPRC8 flag set.

5. The queue has been purged as a result of a previous invocation of the global user exit program. A new allocate request has been received and is about to be allocated because a session has become free.

In this case, the exit program returns with UERCNORM to indicate that CICS is to continue processing normally. This also causes the UEPRC8 flag to be unset and CICS to issue message DFHZCbbbb.

#### Extending the sample program

The sample exit program does not attempt to control the queue length. This kind of enhancement is something you might want to add to your own exit program.

You can also use more complex decisions (such as adding time delays to lessen the risk of false diagnosis) to decide when to issue the return codes that purge the queue, and allow queuing to restart.

## XRF request-processing program exit XXRSTAT

XXRSTAT enables you to decide whether to terminate CICS when either of the following occurs:

- CICS is notified of a VTAM failure by the TPEND exit.

- A **predatory takeover**. A “predatory takeover” can occur, if you are using VTAM Release 3.4.0 or above, and a VTAM application with the same APPLID as that of the executing CICS system assumes control of all the sessions of the executing CICS system.

XXRSTAT gives you the choice of allowing the system which has suffered the takeover to continue or to terminate.

To avoid potential integrity exposures, CICS default action after a predatory takeover is to terminate without a dump. If you want CICS to terminate with a dump, your exit program should return UERCABDU. CICS terminates with the abend code specified by your exit program.

If you want CICS to continue after a predatory takeover, your exit program must return UERCCOIG. Message DFHZC0101 is issued and CICS continues processing without VTAM support. The predatory application assumes control of all VTAM sessions.

**Note:** Allowing CICS to continue after a predatory takeover could cause integrity problems and is not recommended. You are also recommended to use RACF to protect your CICS APPLIDs.

For more information about this exit and the circumstances in which you can use it, refer to the *CICS/ESA 3.3 XRF Guide*.

## Exit XXRSTAT

### When invoked

After either of the following:

- CICS is notified of a VTAM failure by the TPEND exit.
- A predatory takeover.

### Exit-specific parameters

#### UEPERRA

Address of parameter list containing:

#### UEPGAPLD

Address of the 8-byte generic applid

#### UEPSAPLD

Address of the 8-byte specific applid

#### UEPDOMID

Address of the 4-byte domain ID

#### UEPERRID

Address of the 4-byte error ID.

### Note:

1. No DSECT is provided for the above parameter list. You need to code your own DSECT to access the named fields.
2. When VTAM has failed, the domain ID is 'ZC ' (uppercase Z, uppercase C, and two blanks), and the error ID is the character string '3443'.

### Return codes

#### UERCNORM

Take the system action. The system action depends on the reason why the exit was invoked:

- For XRF, in the event of a VTAM failure: CICS continues processing as if the exit program had not been invoked.
- For VTAM persistent sessions, in the event of a predatory takeover: CICS abends without a dump.

**UERCCOIG**

Ignore.

**UERCABNO**

Abend CICS without a dump.

**UERCABDU**

Abend CICS with a dump.

**UERCPURG**

Task purged during XPI call.

**XPI calls**

All can be used.





---

## Chapter 2. Task-related user exit programs

This chapter describes a special kind of user exit called a **task-related user exit (TRUE)**. The chapter is divided into the following sections:

1. “Introduction to the task-related user exit mechanism (the adapter)”
2. “The stub program” on page 269
3. “Writing a task-related user exit program” on page 271
4. “Administering the adapter” on page 302.

---

### Introduction to the task-related user exit mechanism (the adapter)

A task-related user exit allows you to write your own program to access a resource, such as a database, that would not otherwise be available to your CICS system. Such a resource is known as a non-CICS resource. The exit is said to be task-related because it becomes part of the task that invoked it and because, unlike a global user exit, it is not associated with an exit point. You do not have to use any of the task-related user exits, but you can use them to extend and customize the function of your CICS system according to your own requirements.

The most common use of a task-related user exit is to communicate with a resource manager external to CICS; for example, a file or database manager. The CICS interface modules that handle the communication between the task-related user exit and the resource manager are usually referred to as the resource manager interface (RMI) or the task-related user exit interface.

The task-related user exit mechanism is known as an **adapter** because it provides the connection between an application program that needs to access a non-CICS resource and the manager of that resource. Figure 4 on page 268 illustrates the adapter concept.

The adapter is made up of three or more locally-written programs. These are a “stub” program, a task-related user exit program, and one or more administration routines or programs.

The **stub program** intercepts a request (for example, to access data held on an external database manager) issued by the calling application program. The stub can be used to resolve a locally-defined high-level language command into a task-related user exit macro call, DFHRMCAL, which then causes CICS to pass control to the task-related user exit program.

The **task-related user exit program** translates commands for accessing a non-CICS resource into a form acceptable to the resource manager. The program must be written in assembler language, and can reside above or below the 16MB line. For more guidance information about addressing and residency modes, refer to “Addressing-mode implications” on page 289. The program must not alter the contents of any access registers. It is executed in response to a specific application program request, for example, to read data from an external database. In this instance, it may be passed application data, such as a search argument for a required record. Responses from the resource manager are passed back to the calling program by the task-related user exit program.

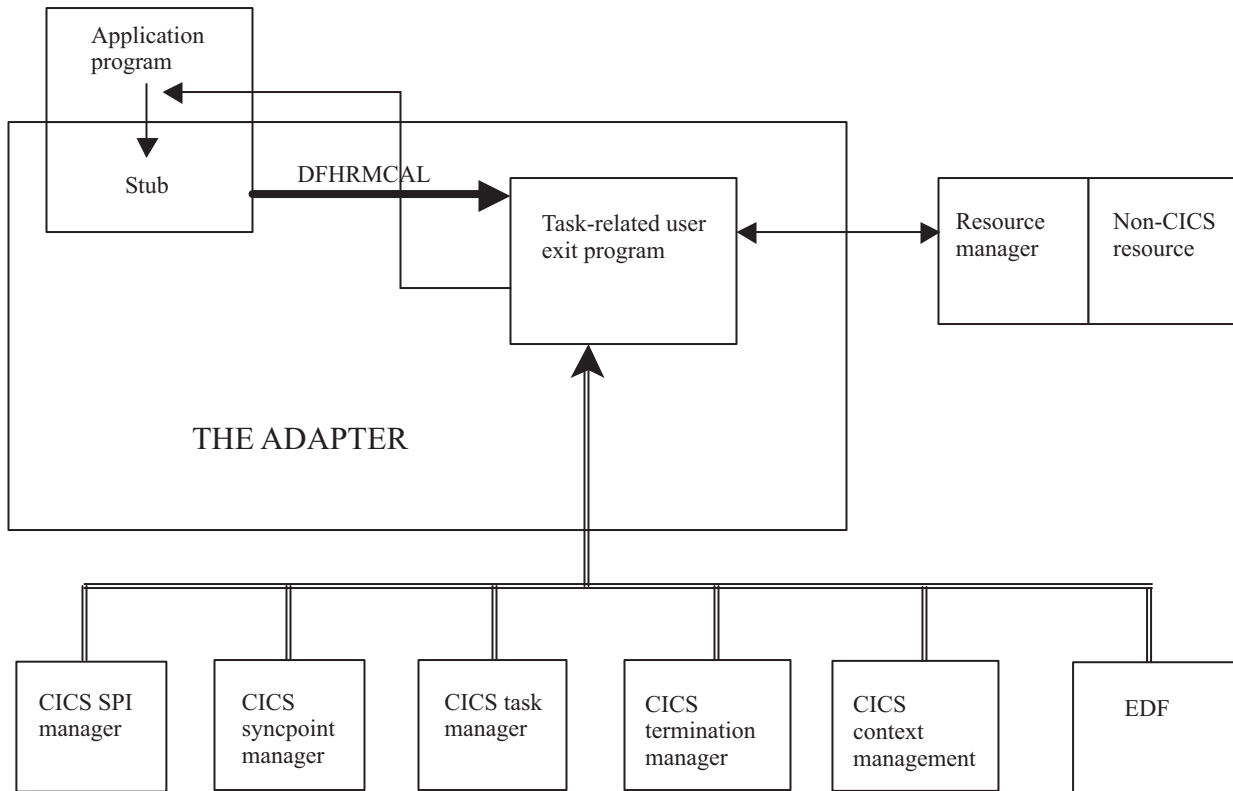

Figure 4. The adapter concept

The task-related user exit program is provided with a parameter list (DFHUEPAR) by the CICS management module that handles task-related user exits. This parameter list gives the task-related user exit access to information such as the addresses and sizes of its own work areas.

The task-related user exit program can be invoked by any of the following:

- An application program
- CICS SPI manager
- CICS syncpoint manager
- CICS task manager
- CICS termination manager
- CICS context management
- The Execution Diagnostic Facility (EDF)

The parameter list serves to distinguish between these various callers, and gives access to a register save area containing the caller's registers.

The **administration routines** contain the EXEC CICS ENABLE and DISABLE commands that you use to install and withdraw the task-related user exit program.

The administration routines may also contain commands to retrieve information about one of the exit program's work areas (the EXEC CICS EXTRACT EXIT command), and to resolve any inconsistency between CICS and a non-CICS resource manager after a system failure (the EXEC CICS RESYNC command). For programming information about the EXEC CICS ENABLE PROGRAM, DISABLE PROGRAM, EXTRACT EXIT, and RESYNC ENTRYNAME commands, refer to the *CICS System Programming Reference* manual.

The remainder of this section discusses each of these parts of the adapter in turn.

## The stub program

The purpose of the stub program is to shield your application programmers from the mechanics of non-CICS resource managers. It is written in assembler language. After assembly, the stub is link-edited to each application program that wants to use it. See Figure 5.

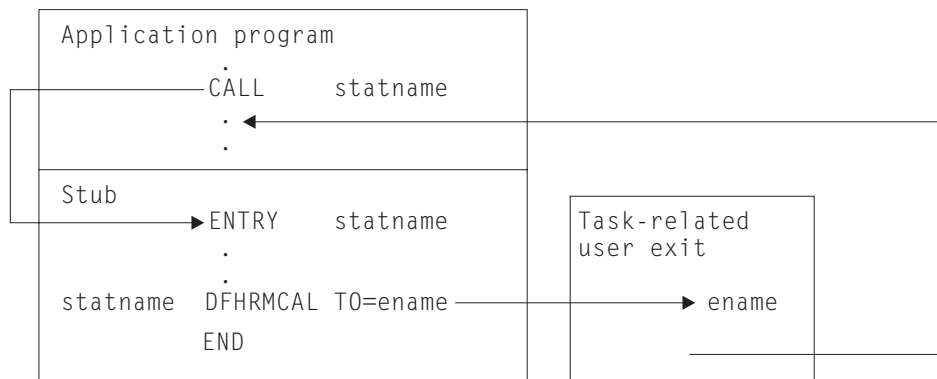

Figure 5. The stub concept

### statname

is a label that can be referenced externally. It should conform to the requirements of an assembler-language ENTRY statement, and typically resolves a V-type address constant, or the target of a high-level language CALL. A single stub may contain several such labels.

### ename

is the entry name (specified on the EXEC CICS ENABLE command) of the task-related user exit program that you want to handle resource manager requests.

You can define high-level language commands for your programmers to use when they want to access a non-CICS resource. If you do this, you must use a translator to convert a locally-defined high-level language command into a conventional CALL to the required entry point of the stub program. Alternatively, the application program can issue a CALL naming the stub entry point, as shown in Figure 5. For example, to read a record from a non-CICS resource, an application program can use the COBOL statement:

```
CALL 'XYZ' USING PARM1 PARM2...
```

XYZ is an entry point (the statname) in your stub program. The stub converts the command into a macro call (DFHRMCAL) to the task-related user exit program, specified in the TO= operand. Return from the task-related user exit program is to the calling application program, not to the stub program.

The application can use a parameter to determine whether the resource manager was called. For example, if the application sets a parameter to zero and the resource manager sets it to nonzero, the parameter value on return indicates whether the resource manager was invoked.

**Note:** The only operands of the DFHRMCAL macro intended for customer use are TO, RTNABND, and SUPPEDF (the latter two being described below). The other operands are for CICS internal use only.

## Returning control to the application program

If you specify RTNABND=YES in the DFHRMCAL macro, control returns to the application program when the task-related user exit is not available, for example, because it is not enabled or started. Note that for assembler-language application programs, a negative value in register 15 signals to the application program that control has returned because the exit is not available. The task-related user exit program can use positive values (including zero) in register 15 to pass resource manager response codes to the application program.

If you do not specify RTNABND=YES and the task-related user exit is not available, the application program terminates abnormally with the abend code 'AEY9'.

## Task-related user exits and EDF

When a task-related user exit (TRUE) is invoked for a call to a non-CICS resource manager from an application that is being monitored by EDF, EDF's default action is to display the parameters that are addressed by the parameter list passed by the DFHRMCAL macro. However, the parameter list can be transformed into a more meaningful display by the TRUE itself. This is done by specifying FORMATEDF on the EXEC CICS ENABLE command that enables the TRUE. The latter is then invoked several times, before and after the invocation to satisfy the call to the resource manager, to format the data to be displayed by EDF and to deal with any changes made by the user to the data on the EDF screen.

For more information about how to format screens for EDF, refer to "CICS EDF build parameters" on page 283 and "Using EDF with your task-related user exit program" on page 301.

If a task-related user exit program contains EXEC CICS commands, EDF may be useful in debugging the TRUE itself. If you want EDF to display commands from the TRUE, you must specify the EDF option when the TRUE program is translated. The standard EDF screens for the CICS commands are then displayed between the "About to Execute" and "Command Execution Complete" screens for the call to the resource manager. However, as EDF is primarily an application debugging tool and the CICS commands within the TRUE would not generally be of interest to the application programmer, the TRUE program is normally translated with the "NOEDF" option; in this case, screens for CICS commands within the TRUE are suppressed.

**Note:** If you specify SUPPEDF=YES on the DFHRMCAL macro, the "About to Execute" and "Command Execution Complete" screens relating to DFHRMCAL's invocation of the TRUE are suppressed; in other words, DFHRMCAL becomes "invisible" to EDF. (Specifying SUPPEDF=YES has no effect in determining whether EDF displays EXEC CICS commands within the TRUE—the factors governing this are as described above—but it **does** suppress the display of parameters passed to the TRUE.)

---

## Writing a task-related user exit program

The main function of the task-related user exit program is to translate the calling program's parameters into a form acceptable to your non-CICS resource manager, and then to pass control to the resource manager. You therefore need to be familiar with your resource manager's syntax requirements. The calling program's parameters are described in "Caller parameter lists" on page 279.

This section describes the user exit parameter lists, the schedule flag word, which is used by the exit program to register its need to be invoked by CICS management services, and register-handling in the task-related user exit program. This section also discusses the use of the CICS syncpoint manager and the CICS task manager. It also discusses some factors that you should consider if you plan to use TCBs provided by the CICS open transaction environment (OTE).

## Obligations of OPENAPI task-related user exits

Open API task-related user exits (that is, exits enabled with the OPENAPI option) are invoked on an open L8 mode TCB instead of the main CICS QR TCB. If a TRUE wants to invoke an external resource manager *without* the benefit of the open API facility, it has to manage its own set of subtask TCBs. It can then use one of these private TCBs on which it can run the request to access the external resource manager. Typically, the subtask TCB is posted to access the external resource manager, while the CICS task running on the QR TCB in the TRUE is put into a CICS dispatcher wait until the subtask completes its work. The CICS dispatcher wait allows the CICS dispatcher to dispatch another CICS task on the QR TCB in the meantime. The reason for this architecture is that external resource managers cannot be invoked directly by a caller on the QR TCB, because any operating system wait issued by the external resource manager would halt the QR TCB, and thereby the whole of CICS.

An open API TRUE is invoked on an L8 mode TCB, which is dedicated for use by the calling CICS task, and is separate from the CICS QR TCB. Therefore, a TRUE can invoke its external resource manager on the allocated L8 TCB and avoid the need to manage its own set of subtask TCBs. An operating system wait issued by an external resource manager will halt the L8 TCB, but CICS continues processing on the QR TCB, and on other open TCBs.

An open API TRUE, although freed from the constraints imposed by the QR TCB, and from having to create subtask TCBs, nevertheless does have obligations both to the CICS system as a whole and to future users of the L8 TCB it is using. An L8 TCB is dedicated for use by the CICS task to which it is allocated, but once the CICS task has completed, the L8 TCB is returned to the dispatcher-managed pool of L8 mode TCBs, provided it is still in a "clean" state. (An **unclean** TCB in this context means that the task using the L8 mode TCB suffered an unhandled abend in an open API TRUE, and not that the TRUE has broken the threadsafe restrictions, which CICS would not detect.) Note that the L8 TCB is not dedicated for use by a particular open API TRUE, but is used by all open API TRUES and OPENAPI programs invoked by the CICS task to which the L8 mode TCB is allocated. Also, if an application program invoking an open API TRUE is coded to threadsafe standards, and defined to CICS as threadsafe, it continues to execute on the L8 mode TCB on return from the TRUE. When considering whether to exploit CICS OTE support rather than manage your own subtask TCBs, consider the restrictions listed below. You can then decide whether to work within these restrictions or to use your own subtask TCB, which is dedicated for your own TRUE's use.

## Threadsafe restrictions

An open API TRUE must not treat the executing open TCB environment in such a way that it causes problems for:

- Other open API TRUEs called by the same task
- OPENAPI programs called by the same task
- Application program logic that could run on the open TCB
- Future tasks that might use the open TCB
- CICS management code.

In particular:

- When invoking CICS services, or when returning to CICS, an open API TRUE must ensure it restores the MVS programming environment as it was on entry to the TRUE. This includes cross-memory mode, ASC mode, request block (RB) level, linkage stack level, TCB dispatching priority, in addition to cancelling any ESTAEs added.
- At CICS task termination, an open API TRUE must ensure it leaves the open TCB in a state suitable to be reused by another CICS transaction. In particular, it must ensure that all non-CICS resources acquired specifically on behalf of the terminating task are freed. Such resources might include:
  - Dynamically allocated data sets
  - Open ACBs or DCBs
  - STIMERM requests
  - MVS managed storage
  - ENQ requests
  - Attached subtasks
  - Loaded modules
  - Owned data spaces
  - Added access list entries
  - Name/token pairs
  - Fixed pages
  - Security settings (TCBSENV must be set to zero)
- An open API TRUE must not use the following MVS system services that will affect overall CICS operation:
  - CHKPT
  - ESPIE
  - QEDIT
  - SPIE
  - STIMER
  - TTIMER
  - XCTL / XCTLX
  - Any TSO/E services.
- An open API TRUE must not invoke under the L8 mode TCB a Language Environment program that is using MVS Language Environment services, because L8 mode TCBs are initialized for Language Environment using CICS services.

## Calling an OPENAPI task-related user exit

If a task-related user exit is enabled with the OPENAPI option, CICS uses the following rules, based on the type of call, to determine the TCB on which it should invoke the TRUE—on the QR TCB, on the caller's TCB, or an L8 mode TCB:

**Application program call (API)—UERTAPPL**

For this call, CICS always invokes the TRUE on an L8 mode TCB

**CICS syncpoint manager call—UERTSYNC**

For this call, CICS always invokes the TRUE on an L8 mode TCB

**CICS task manager call—UERTTASK**

For this call, the TCB on which CICS invokes the TRUE is further determined by the type of task manager call:

**UERTSOTR—Start of task**

For this call the open API option is ignored for performance reasons, and CICS always invokes the TRUE on the QR TCB.

**UERTEOTR —End of task**

For this call, CICS always invokes the TRUE on an L8 mode TCB.

**EDF call—UERTFEDF**

For this call, CICS always invokes the TRUE on an L8 mode TCB

**CICS SPI call—UERTSPI**

For this call, CICS always invokes the TRUE as a threadsafe TRUE on the TCB on which the task is currently running at the time of the call.

The SPI function, which is to satisfy EXEC CICS INQUIRE EXITPROGRAM commands on which the CONNECTST or QUALIFIER option are specified, is simple and does not require invocation on a specific TCB.

**CICS termination call—UERTCTER**

For this call the open API option is ignored and CICS always invokes the TRUE on the QR TCB.

**Note:** Even for call types that are invoked on an L8 TCB, it is possible that the L8 TCB could suffer an asynchronous abend and therefore not be available for subsequent use, with the following result:

- If CICS is unable to switch to the L8 TCB for an API call to a TRUE, CICS abends the transaction.
- If CICS is unable to switch to the L8 TCB for a syncpoint or end of task call, CICS invokes the TRUE on the QR TCB instead.

The TCB mode on which the task-related user exit is being called is provided in the second and third bytes of a three-byte field addressed by the UEPTIND parameter. See Table 13 on page 277 for details.

## User exit parameter lists

When a task-related user exit is invoked, the CICS management module that handles task-related user exits provides the exit with a parameter list. The address of this parameter list is passed in register 1. The list contains the following information:

- The identity of the caller
- Addresses and sizes of any work areas that are available to the task-related user exit program
- The address of the register save area of the caller
- The address of an EXEC interface block (EIB) that is for use by the task-related user exit program during this invocation
- The address of the identifier of the current unit of recovery
- The address of the schedule flag word

- The address of the kernel stack entry
- The address of the APPC unit of work (UOW) identifier
- The address of the user security block flag
- The address of the user security block
- The address of the resource manager qualifier name
- The address of the resource manager's "single-update" and "read-only" indicator byte
- The address of the caller's AMODE indicator byte
- The address of the application's DATALOC and TASKDATAKEY indicator byte
- The address of the performance block token
- The address of a trace flag.

To enable your exit program to access this parameter list, you must include in it the macro:

```
DFHUEXIT TYPE=RM
```

The DFHUEXIT TYPE=RM macro causes the assembler to create the storage definitions (DSECTs) DFHUEPAR, DFHUERTR, and DFHUECON. If you want your task-related user exit to be able to format screens for EDF, you must include in it the macro:

```
DFHUEXIT TYPE=RM,DSECT=EDF
```

This causes the assembler to create the UEPEDFRM DSECT, which is described in "CICS EDF build parameters" on page 283. All of the user exit parameter lists are summarized in Figure 7 on page 286.

The format and the purpose of these definitions are described below.

## DFHUEPAR

DFHUEPAR gives you the following symbolic names for address parameters:

### UEPEXN

Address of the function definition, which tells the task-related user exit program why it is being called. See "DFHUERTR (the function definition)" on page 278 for more details.

### UEPGAA

Address of the global work area requested in the EXEC CICS ENABLE command. The global work area is described on page "The global work area" on page 292. CICS initializes this work area to X'00' when the task-related user exit program is enabled.

### UEPGAL

Address of a halfword containing the length (binary value) of the global work area.

### UEPTCA

This field is retained for historical reasons. It should **not** be referenced by your exit program.

### UEPCSA

This field is retained for historical reasons. It should **not** be referenced by your exit program.

### UEPHMSA

Address of the register save area (RSA) of the caller. It is an 18-word save



area, with the contents of registers 14 through 12 stored in the fourth and subsequent words. Its fifth word, representing the calling program's register 15, is cleared by CICS before the task-related user exit program is invoked, so that it can be used to convey response codes from the resource manager to the calling program. For this reason you cannot use register 15 to send data to the task-related user exit program. The seventh word of the save area contains the caller's register 1. Register 1 addresses the caller's parameter list if the exit program is being invoked by the CICS task manager or the CICS syncpoint manager, by EDF, or at CICS termination. When the caller is an application program, the contents of register 1 are determined by the linkage conventions of the adapter's language interface.

#### **UEPTAA**

Address of the local work area requested in the EXEC CICS ENABLE command. The local work area is described on page "The local work area" on page 293. CICS initializes the work area to X'00' throughout on first acquiring the area; that is, when the task first invokes the task-related user exit program.

#### **UEPTAL**

Address of a halfword containing the binary length of the local work area.

#### **UEPEIB**

Address of the EXEC interface block (EIB) created by CICS for the task-related user exit program. The EIB exists only for the duration of the call and it allows the task-related user exit program to request CICS services through the command-level interface. This is not the same EIB that is available to the calling program, so you cannot access the calling program's environment other than by UEPHMSA (see above), which provides the address of the calling program's register save area (RSA).

#### **UEPURID**

Address of CICS unit of recovery identifier. This field contains the 8-byte date and time value that is generated by an STCK instruction, and it identifies the current unit of work.

#### **UEPFLAGS**

Address of the schedule flag word. This is a fullword that the task-related user exit program uses to register its need for CICS management programs' services. For more information, see "The schedule flag word" on page 287.

#### **UEPRMSTK**

Address of the kernel stack entry.

#### **UEPUOWDS**

Address of the APPC unit of work (UOW) identifier.

#### **UEPSECFLG**

Address of the user security flag. The user security flag is a 1-byte field that can take the following values:

##### **UEPNOSEC (X'80')**

Security is not active for this CICS system.

##### **UEPSEC (X'20')**

Security is active for this CICS system. Only in this case is the address of the "user security block" set.

#### **UEPSECBLK**

Address of a fullword that addresses the "user security block"—that is, the ACEE.

## **UEPRMQUA**

Address of an 8-byte field into which the task-related user exit can move the qualifier name of the resource manager on each API request. This is useful where the same exit program is used to connect to more than one instance of a resource manager; the qualifier identifies the instance of the resource manager to which the exit is currently connected.

Where different resource manager qualifiers are returned on the responses to various API requests within a UOW, it is the resource manager qualifier returned on the final API request immediately before a prepare or backout invocation that is used when recording any in-doubt information.

## **UEPCALAM**

Address of caller's AMODE indication byte.

**X'80'** Indicates that the original caller was in AMODE 31. If the top bit is not set, then the caller was in AMODE 24.

## **UEPSYNCA**

Address of the single-update and read-only indication byte. This field contains flags that your exit program can set to indicate that the resource manager “understands” the single-update protocol, and to record the status of the current unit of work (UOW). See “Increasing efficiency – single-update and read-only protocols” on page 294.

### **UEPSUPDR (X'80')**

The resource manager understands the single-update protocol. That is, your exit program can instruct the resource manager to perform a single-phase commit, in appropriate circumstances.

### **UEPREADO (X'40')**

The resource manager understands the read-only protocol, and has been in read-only mode for this UOW so far. (If this flag is not set, it means either that the UOW contains updates for this resource manager, or that the UOW may be read-only but the resource manager does not understand the read-only protocol.)

## **UEPTIND**

Address of a 3-byte field containing indicators.

The first indicator byte can take one of three symbolic values, UEPTANY, UEPTCICS, and UEPTUTCB, which you can test to determine: whether data locations can be above or below 16MB; whether the application's storage is in CICS-key or user-key storage; and whether the TRUE has been called by an unexpected TCB:

### **UEPTANY (X'80')**

The application can accept addresses above 16MB. If the symbolic value is not UEPTANY, the application must be returned an address below 16MB.

### **UEPTCICS (X'40')**

The application's working storage and task life-time storage are in CICS-key storage (TASKDATAKEY=CICS). If the symbolic value is not UEPTCICS, the application's working storage and the task's life-time storage are in user-key storage (TASKDATAKEY=USER).

### **UEPTUTCB (X'20')**

Indicates an unexpected TCB. Set on a syncpoint or end-of-task call only, this indicates a failure to switch to the TCB expected by the task-related user exit. In these two cases, the task-related user

exit is called on the QR TCB with the UEPTUTCB bit set. For all other calls, CICS abends the transaction without invoking the task-related user exit.

The second and third bytes contain a value indicating the TCB mode of its caller. This is represented in DFHUEPAR as both a two-character code and a symbolic value, as follows:

Table 13. TCB indicators in DFHUEPAR. Description

Symbolic value	2-byte code	Description
UEPTQR	QR	The quasi-reentrant mode TCB
UEPTRO	RO	The resource-owning mode TCB
UEPTCO	CO	The concurrent mode TCB
UEPTSZ	SZ	The FEPI mode TCB
UEPTRP	RP	The ONC/RPC mode TCB
UEPTFO	FO	The file-owning mode TCB
UEPTSL	SL	The sockets listener mode TCB
UEPTSO	SO	The sockets mode TCB
UEPTS8	S8	The secure sockets layer mode TCB
UEPTD2	D2	The CICS–DB2 housekeeping mode TCB
UEPTJ8	J8	The J8 open TCB, used for JVMs that are in CICS key
UEPTJ9	J9	The J9 open TCB, used for JVMs that are in user key
UEPTJM	JM	The JM open TCB, used with the IBM SDK for z/OS, V1.4.2 for the master JVM that initializes the shared class cache
UEPTL8	L8	An L8 open TCB, used for OPENAPI TRUEs, or OPENAPI programs that are in CICS key
UEPTL9	L9	An L9 open TCB, used for OPENAPI programs that are in user key
UEPTX8	X8	An X8 open TCB, used for C and C++ programs, compiled with the XPLINK option, that are in CICS key
UEPTX9	X9	An X9 open TCB, used for C and C++ programs, compiled with the XPLINK option, that are in user key

### UEPPBTK

Address of a 4-byte field containing the z/OS Workload Manager (WLM) Performance Block Token. An exit program can use this token to:

- Access information (such as the service class token, SERVCLS) in the WLM Performance Block. To do so, it must use the WLM EXTRACT macro, IWMMEXTR, passing the Performance Block Token as the MONTKN input parameter. For more information about the IWMMEXTR macro, see *z/OS MVS Programming: Workload Management Services*.
- Relate its resource manager's performance blocks for the work request with the original CICS performance block. For example, DBCTL and DB2 need to correlate the work they do on behalf of CICS with the originating CICS task, so that the z/OS Workload Manager can measure the performance of the whole CICS task. To do this it must use the WLM IWMMRELA macro.

An exit program must make no assumptions about the contents of the Performance Block and *must not attempt to modify it*: if it does so, the results are unpredictable.

#### **UEPTRCE**

Address of a 1-byte trace flag indicating whether RMI tracing (the RI trace component) is active.

#### **UEPTRLV1 (X'80')**

RMI level 1 trace is active.

#### **UEPTRLV2 (X'40')**

RMI level 2 trace is active.

Having tested this field, the task-related user exit could, for example, issue an EXEC CICS SET TRACETYPE command to reset the level of RMI tracing.

### **DFHUERTR (the function definition)**

The function definition identifies the caller of the task-related user exit program. The DSECT contains two symbolic definitions (fields).

#### **UERTFGP**

A single byte that is set to X'00'. The zero setting shows that this is a task-related user exit invocation and that the parameter list therefore includes the fields UEPTAA, UEPTAL, UEPEIB, UEPURID, and UEPFLAGS.

#### **UERTFID**

A single-byte identifier that shows whether this call has been made by an application program, the CICS SPI manager, the CICS syncpoint manager, the CICS task manager, the CICS termination manager, CICS context management, or by EDF. It can have one of the following seven settings:

#### **UERTSPI**

(X'01') CICS SPI call.

#### **UERTAPPL**

(X'02') Application program call.

#### **UERTSYNC**

(X'04') CICS syncpoint manager call.

#### **UERTTASK**

(X'08') CICS task manager call.

#### **UERTCTER**

(X'0A') CICS termination call.

#### **UERTFEDF**

(X'0C') EDF call.

#### **UERTFCON**

(X'0E') CICS context management call.

It is important to know which type of program has made the call because it affects how the calling program's parameter list is interpreted by the task-related user exit program.

## Caller parameter lists

In addition to the DSECTs DFHUEPAR and DFHUERTR, the inclusion of DFHUEXIT TYPE=RM in the task-related user exit program provides some field definitions that are specific to the caller of the task-related user exit. The calling program's parameter list is normally addressed by R1 in the calling program's RSA. This RSA is addressed by field UEPHMSA of DFHUEPAR. These parameters are described below.

### ***Application program parameters:***

If the caller is an application program, the format and addressing of its parameter list are decided locally.

### ***CICS SPI parameters:***

If you enable your task-related exit program with the SPI option of the EXEC CICS ENABLE PROGRAM command (or the program itself “expresses interest” in SPI calls—see “The schedule flag word” on page 287), the exit program can be invoked to satisfy EXEC CICS INQUIRE EXITPROGRAM commands on which the CONNECTST or QUALIFIER option is specified. This allows applications to query whether the exit program is connected to its resource manager, and its entryname-qualifier. For information about the INQUIRE EXITPROGRAM command, see the *CICS System Programming Reference* manual.

The CICS SPI parameter list contains two entries:

#### **Parameter 1**

The address of a 1-byte output field, which your task-related exit program should use to indicate whether it is connected to its external resource manager. The equated return code values are:

#### **UERTCONN**

(X'80') The exit is connected to its resource manager.

#### **UERTNCONN**

(X'40') The exit is not connected to its resource manager.

#### **Parameter 2**

The address of an 8-character output field, in which your task-related exit program should return the qualifier of the external resource manager, if known. See the UEPRMQUA parameter in “DFHUEPAR” on page 274 for more information on qualifier names.

### ***CICS syncpoint manager parameters:***

The CICS syncpoint manager's parameter list contains ten entries, although on most invocations only parameters 1 and 10 contain values. The operation bytes pointed to by parameters 1 and 10 contain flags which, when combined, form an operation code that tells the TRUE why it has been invoked.

Parameters 2 through 9 contain values only when the syncpoint manager makes a “Commit Unconditionally” or “Backout” call to the TRUE, for resynchronization purposes after a session or system failure. These extra parameters point to fields that identify the task, the transaction that started the task, the terminal from which it was initiated, the identity of the terminal operator, the date and time of the failing syncpoint, and (if there are no further units of recovery associated with the task) the next transaction code. Typically, you would use these values to create meaningful

messages for resource recovery. They are presented explicitly because, after a system failure, the task driving the exit is not the task that originally scheduled the recoverable work. These additional parameters describe the **original** task's environment and are accessed directly.

The full parameter list is as follows:

#### Parameter 1

The address of operation byte 1, which contains the following flags:

##### **UERTPREP**

(X'80') Prepare to commit (that is, perform the first phase of a two-phase commit).

##### **UERTCOMM**

(X'40') Commit unconditionally (perform the second phase of a two-phase commit).

##### **UERTBACK**

(X'20') Backout.

##### **UERTDGCS**

(X'10') Unit of recovery has been lost because of an initial start of CICS.

##### **UERTDGNK**

(X'08') Resource manager should not be in doubt about this unit of recovery.

##### **UERTWAIT**

(X'04') Resource manager must wait for the outcome of this unit of recovery. This value is set at phase two of a two-phase commit, if CICS is in-doubt about the outcome of a UOW. It occurs only if the task-related user exit is enabled with the INDOUBTWAIT option (see "Enabling for specific invocation-types" on page 303).

##### **UERTRSYN**

(X'02') This syncpoint request was generated as the result of an EXEC CICS RESYNC command.

##### **UERTLAST**

(X'01') There are no further units of recovery associated with this task. Note that when this bit is **not** set, there may or may not be further units of recovery. For this reason, it is not recommended that you rely on this bit to signal end-of-task. You should instead schedule the CICS task manager to drive you at end-of-task by setting the task manager bit in the schedule flag word. If you do use UERTLAST to signal end-of-task, and if at that stage you can complete your clean-up process, you can set the task manager bit off in the schedule flag word when the clean-up process is finished, to avoid an unnecessary invocation by the CICS task manager.

The only **valid bit combinations** are those produced by combining one of UERTPREP, UERTCOMM, UERTBACK, UERTDGCS, and UERTDGNK with either UERTLAST or UERTRSYN, or both; or by combining UERTWAIT and UERTLAST.

Your exit program should examine the flags set both in this byte and in operation byte 2 (see parameter 10), to determine what action is expected of it.

#### Parameter 2

If not zero, the address of a 4-byte, packed-decimal field identifying the original

task. But note that, on many invocations of the exit program, parameters 2 through 9 do not contain values. See note 1.

**Parameter 3**

Address of a 4-character field identifying the transaction that started the original task. See note 1.

**Parameter 4**

Address of a 4-character field identifying the terminal from which the original task was initiated. See note 1.

**Parameter 5**

Address of a 4-character field containing the identity of the terminal operator (OPID) who initiated the original task. See note 1.

**Parameter 6**

Address of a 4-byte, packed-decimal field containing the date of the failing syncpoint, in the format 0Cyydddss, where:

- **C** is a century indicator. (0=1900, 1=2000, 2=2100, and so on.)
- **yy**=years.
- **ddd**=days.
- **s** is the sign.

See note 1.

**Parameter 7**

Address of a 4-byte, packed-decimal field containing the time of the failing syncpoint, in the format 0hhmmss+. See note 1.

**Parameter 8**

Address of an 8-byte field containing the resource manager qualifier. See note 1.

To verify that this is a resync for this instance of the resource manager, your exit program should check that the qualifier passed is the one that is currently in use. If it is not, the exit program should ignore the resync and set a return code of UERFHOLD, to indicate that CICS should keep the disposition of the unit of work.

**Parameter 9**

Address of a 4-character field containing the next transaction code. If the transaction ended with an EXEC CICS RETURN without specifying the next transaction code, the addressed field is set to nulls; otherwise, it is set to the value specified by the application. See note 2.

**Parameter 10**

The address of operation byte 2, which contains the following flags:

**UERTONLY**

(X'80') Perform a single-phase commit. (No recoverable resources other than those owned by the resource manager being invoked have been updated during the current UOW.)

**URTELUW**

(X'40') Perform a single-phase commit. (The resource manager was in read-only mode throughout the current UOW.)

Your exit program should examine the flags set both in this byte and in operation byte 1 (see parameter 1), to determine what action is expected of it.

**Note:**

- Parameters 2 through 8 contain values only if the CICS syncpoint manager call is prompted by the issue of an EXEC CICS RESYNC command after a session or system failure, and operation byte 1 contains the bit settings UERTCOMM or UERTBACK. Otherwise, they are set to X'00' (hexadecimal zero). For programming information about the EXEC CICS RESYNC command and about the completion of the syncpointing procedure following a system failure, refer to RESYNC ENTRYNAME, in the *CICS System Programming Reference* manual. Note that parameters 2 through 8 describe the environment of the **original** task (not of the task that is currently driving the TRUE).
- Unless the UERTLAST bit is set in operation byte 1, parameter 9 is a zero address. Although for a call prompted by an EXEC CICS RESYNC call, the UERTLAST bit will be set on, in this case the next transaction code does not apply and so Parameter 9 addresses a field set to nulls.

***CICS task manager parameters:***

There are either one or two entries in the CICS task manager's parameter list, depending on the reason for the call to the TRUE: on start-of-task calls, the parameter list contains one entry, while on end-of-task calls, it contains two. Each entry consists of an address, and the end of the parameter list is indicated by the top bit of the address being set.

The significance of the parameters is as follows:

**Parameter 1**

The address of a single byte with bit definitions indicating the reason for the call:

**UERTSOTR**

(X'40') Start of CICS task

**UERTEOTR**

(X'80') End of CICS task.

**Parameter 2**

This parameter is passed only on end-of-task calls. It is the address of a 4-character field which contains the next transaction code specified on the EXEC CICS RETURN command. If the transaction ends with an EXEC CICS RETURN without specifying a next transaction, this field is set to nulls.

The schedule flag word should be set during the start-of-task call if you want your task-related user exit program to be invoked unconditionally by the CICS syncpoint manager.

***CICS termination manager parameters:***

All task-related user exit programs that have been enabled with the SHUTDOWN option of the EXEC CICS ENABLE command, and started, are invoked at CICS termination to allow them to do the clean-up processing that is appropriate to the type of termination. At CICS termination, the address of a one-byte termination code is passed to your exit program. The code may consist of any of the following bit settings:

**UERTCORD**

(X'80') CICS orderly shutdown

**UERTCIMM**

(X'40') CICS immediate shutdown



**UERTCABY**

(X'20') CICS abend, retry possible, TCBs dispatchable

**UERTCABN**

(X'10') CICS abend, retry not possible, TCBs dispatchable

**UERTOPCA**

(X'01') CICS abend, retry not possible, TCBs not dispatchable.

For further information about shutdown TRUEs, see “Coding a program to be invoked at CICS termination” on page 298.

***CICS context management parameters:***

CICS context management parameters are those parameters that CICS passes when a task-related user exit signals that CICS should be called for CICS context management.

A CICS application that interacts with another (non-CICS) product that supports the Application Response Measurement (ARM) workload balancing and reporting standard can use a task-related user exit program, invoked by CICS context management, to support cross-product workload monitoring. Sometimes, such a task-related user exit program is supplied by the non-CICS, ARM-enabled, product.

If the context management bit in the schedule word is set for the current transaction, CICS context management invokes the exit program whenever the transaction issues a non-terminal-related EXEC CICS START command. The exit program is not invoked for terminal-related EXEC CICS START commands.

On invocation, the exit program is passed the following parameter list, which is mapped by the DFHUECON DSECT:

**UECON\_EXEC\_PLIST\_PTR**

Address of a copy of the parameter list passed to the EXEC CICS START command. Your task-related user exit program can use this to access, for example, the data passed on the FROM parameter of the START command, or the name of the transaction to be started. The EXEC CICS START parameter list is described by the DFHICUED copy book.

**UECON\_CORRELATOR\_PTR**

Address of a 512-byte area in which the exit program can place an ARM workload correlator.

***CICS EDF build parameters:***

On EDF invocations, the address contained in register 1 of the calling program's RSA points to the UEPEDFRM DSECT. This contains the following fields:

**UEPEDFR1**

The address of the application's R1 parameter list.

**UEPEDFFI**

The input flag byte. When a task-related user exit is invoked by EDF, UEPEDFFI can take one or more of the following bit settings:

**UEPEDFRQ**

(X'80') “About to Execute” invocation.

**UEPEDFRS**

(X'40') “Command Execution Complete” invocation.

**UEPEDFRA**

(X'20') About to display command to EDF.

**UEPEDFRC**

(X'10') Command has been displayed to EDF.

**UEPEDFSC**

(X'08') EDF user has changed the screen.

**UEPEDFWS**

(X'04') EDF user has changed working storage.

**UEPEDFNO**

(X'01') EDF user has requested NOOP.

**UEPEDFFO**

The output flag byte. If the task-related user exit requires, it can set the UEPEDFFO flag byte to indicate to EDF what action the task-related user exit wants EDF to take. It can take the following values:

**UEPEDFDF**

(X'80') Take default CICS action. (EDF screen contains the uninterpreted caller's R1 parameter list.)

**UEPEDFND**

(X'40') Do not display command to EDF.

**UEPEDFRD**

(X'20') Redisplay command to EDF.

**UEPEDFDL**

EDF screen attributes. These are for information only: the task-related user exit program cannot change these fields.

**UEPEDFPS (halfword binary)**

Page size (number of lines).

**UEPEDFLS (halfword binary)**

Line size.

**UEPEDFMP (halfword binary)**

Maximum number of pages.

**UEPEDFPA**

The address of the EDF display data parameter list, supplied by the task-related user exit. The display data parameter list is composed of alternating pairs of attribute-byte addresses and data-field addresses. Attribute bytes refer to the line of display data pointed to by the data-field addresses. The data field must be the same size as the value specified in UEPEDFLS. The display data is in the format shown in Figure 6 on page 285.

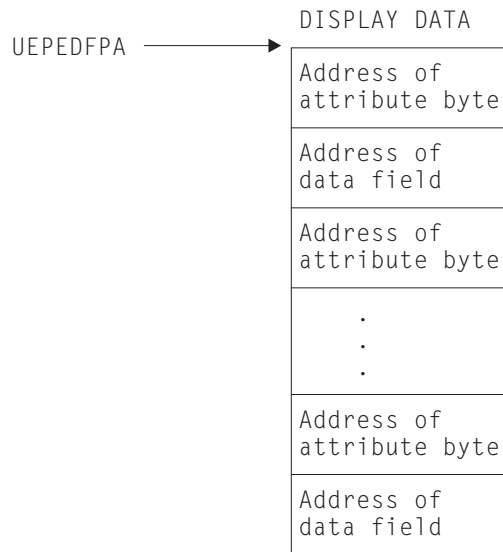

Figure 6. Display data parameter list

**Note:**

1. CICS provides a list of named standard attribute bytes that you may want to use. These standard attribute bytes are contained within DFHBMSCA, which must be copied into your program. For programming information, including a list of the attribute bytes and their meanings, refer to BMS-related constants, in the *CICS Application Programming Reference* manual.
2. The high-order bit must be set **on** in the last address, to indicate to EDF that this is the last address.

**Summary of the task-related user exit parameter lists**

Figure 7 on page 286 shows, in diagrammatic form, the relationships between the parameter lists that are discussed in the preceding sections.

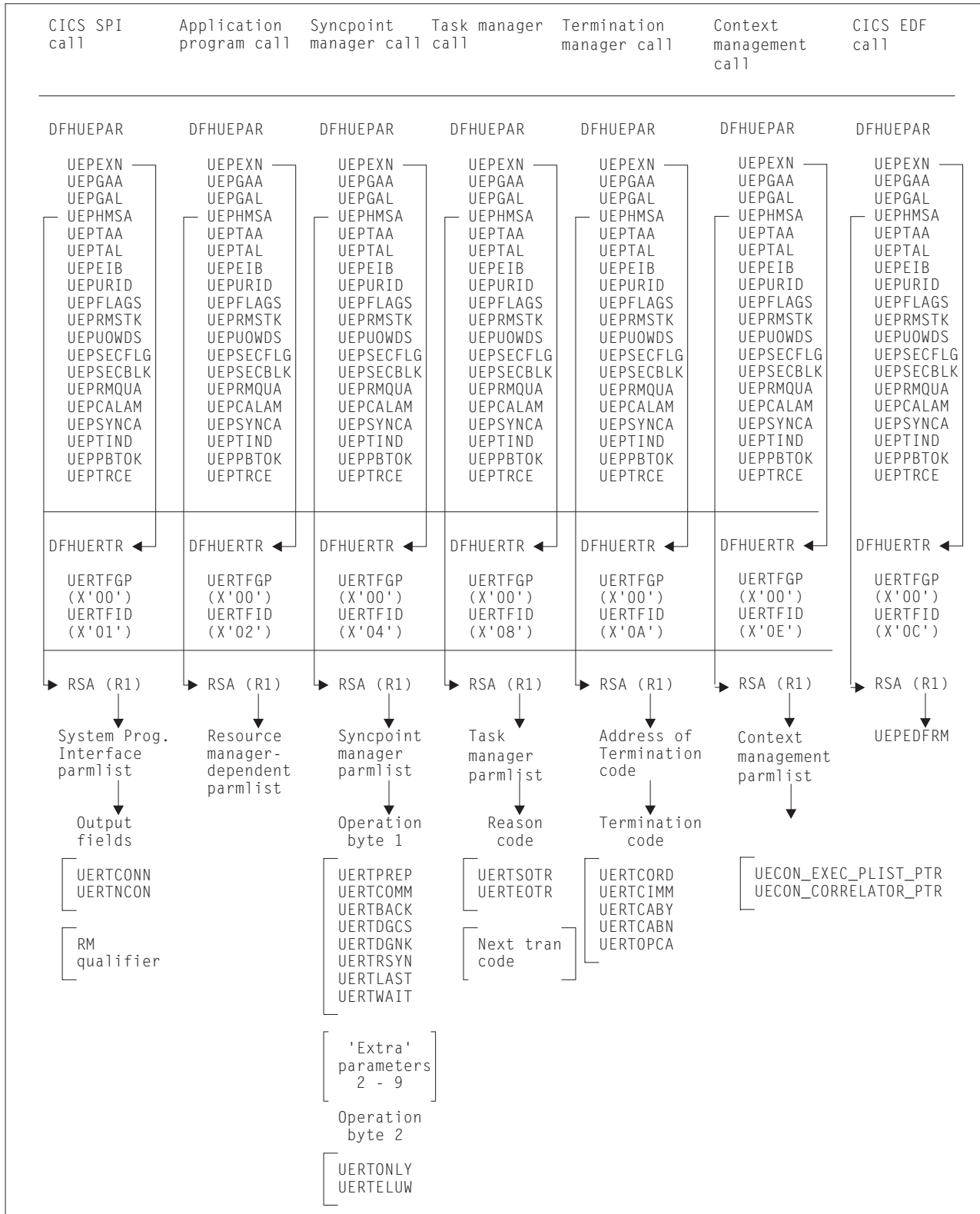

Figure 7. Task-related user exit parameter lists

## The schedule flag word

The schedule flag word is a fullword indicator that the task-related user exit program uses to control its own invocation. It is also used by CICS to schedule the first invocation of a task-related user exit program. The schedule flag word is accessed by the address parameter UEPFLAGS of DFHUEPAR. There is a unique schedule flag word for each association between a CICS task and the ENTRYNAME specified when a task-related user exit program is enabled.

The default setting of the schedule flag word is for application program requests (that is, the last two bytes are set to X'0004').

The format of the schedule flag word is shown in Table 14.

Table 14. Format of the schedule flag word

Byte	Setting	EXEC CICS ENABLE option	Comments
0	—	—	Reserved.
1	—	—	Reserved.
2	UEFDCON UEFD FEDF UEFDCTER UEFDTASK	— — SHUTDOWN —	Bit mask for context management Bit mask for EDF invocation. Bit mask for termination manager Bit mask for task manager.
3	UEFDSYNC UEFDAPPL UEFDSPI	INDOUBTWAIT — SPI	Bit mask for syncpoint manager. Bit mask for application program Bit mask for SPI.

The bit settings of the schedule flag word specify which programs invoke your task-related user exit program. For example, if an exit program is to be invoked by the CICS task manager, the CICS syncpoint manager, **and** an application program, then the last two bytes of the schedule flag word should be set to X'0114'. If an exit program is to be called by the CICS task manager and an application program only, the last two bytes of the flag word should be set to X'0104'. Before the exit program is first called by a task, CICS sets the API flag bit on.

The third column of the table shows the option of the EXEC CICS ENABLE command, if any, that can be used to set the bit for each type of invocation. (How to use options of the EXEC CICS ENABLE command to cause a task-related user exit program to be invoked for specific types of call is described in “Enabling for specific invocation-types” on page 303.)

Before returning from any call, the task-related user exit can change the bit settings of the flag word to register its need to be invoked by a different CICS management service, or to register lack of interest in a service by setting the relevant flag bit to zero.

For example, a task-related user exit may be called by an application program that needs to access a non-CICS recoverable resource. When the exit program is first called, the API bit is set on by CICS. If the calling program then issues a request to update a record, the exit program sets the syncpoint manager bit on in the schedule

flag word. When the calling application program subsequently issues a syncpoint command, or when end-of-task is reached, the CICS syncpoint manager calls the exit program.

**Note:** CICS sets the syncpoint manager bit off after every call to the syncpoint manager. This is to avoid the CICS syncpoint manager invoking the task-related user exit program for a unit of recovery during which the exit program did no recoverable work. The syncpoint manager bit must therefore be set on whenever the exit program performs any recoverable work.

If you set the task manager bit in the schedule flag word on, CICS invokes your task-related exit program at the end of this task. (Note that, if you want your exit program to be called at the **start** as well as at the end of a task, you must specify TASKSTART on the EXEC CICS ENABLE command for the TRUE. This causes the TRUE to be invoked at the start and end of **every** task.)

If the last two bytes of the schedule flag word are set to X'1000', this indicates that the task-related user exit is interested in being invoked by EDF to format requests for display. This schedule flag bit UEFDFEDF is set **on** either by the EXEC CICS ENABLE FORMATEDF command, or by the task-related user exit. Unlike other schedule flag bits, there are restrictions on when the task-related user exit can register a lack of interest in EDF (that is, restrictions on when UEFDFEDF can be set off). Once a task-related user exit has formatted the initial screen for EDF to display on "About to Execute" or "Command Execution Complete", CICS does not allow it to set the EDF bit UEFDFEDF off until the screen build cycle is complete.

## Register handling in the task-related user exit program

In this section, two sets of registers are discussed:

1. The registers belonging to the CICS management module that handles task-related user exits. These are referred to as the **CICS registers**.
2. The registers belonging to the calling program and that are addressed by parameter UEPHMSA of DFHUEPAR. These are referred to as the **calling program's registers**.
3. The registers belonging to the called resource management interface (RMI). These are referred to as the **RMI registers**.

### Saving CICS registers

Your task-related user exit program should begin by saving the contents of the CICS registers. Register 13 addresses an 18-word area into whose 4th and subsequent words your exit program should store registers 14 through 12. Three of the saved values have significance, as follows:

- The saved contents of register 14 contain the address within CICS to which the task-related user exit program returns control.
- The saved contents of register 15 contain the address at which the task-related user exit program has just been entered.
- The saved contents of register 1 address the parameter list (DFHUEPAR) that is provided by CICS for the task-related user exit program.

**Note:** As a general rule, if you fail to understand the origin or the purpose of a call, you should:

1. Restore any registers that you have used to the state they were in on entry to your code
2. Return to the address contained in CICS register 14.

## The calling program's registers

The calling program's registers are stored at the address specified by UEPHMSA of DFHUEPAR. Where the calling program is a CICS management program, for example the syncpoint manager, the only caller registers that have significance are registers 1 and 15. Register 1 addresses the calling program's parameter list. CICS sets the calling program's register 15 to zero before the task-related user exit program is invoked. The calling program's register 15 can sometimes be used to pass responses back to the calling program from the task-related user exit program, depending on the identity of the caller. If the calling program is a CICS management program, and the register is still zero on return, CICS assumes that its call was not understood. If the calling program is an application program, the significance of register settings on return are either described in your resource manager's documentation, or defined locally.

## The RMI registers

CICS does not support 64-bit addressing for applications, but TRUEs can invoke RMI programs that use storage at addresses which are only available when running on 64-bit architecture machines. The CICS dump formatter displays the contents of the 64-bit General Purpose Registers captured when an abend occurs.

## Addressing-mode implications

The task-related user exit is invoked in the AMODE of the caller, unless the exit has been enabled with the LINKEDITMODE option of the EXEC CICS ENABLE command. This option enables the task-related user exit in its link-edit AMODE. Therefore, if the TRUE has been link-edited AMODE 31 and is enabled with the LINKEDITMODE option, it can be placed above the 16MB line. For programming information about the LINKEDITMODE option of the EXEC CICS ENABLE command, refer to ENABLE PROGRAM, in the *CICS System Programming Reference* manual.

## Important

You should avoid the use of the LINKEDITMODE option where the TRUE has been link-edited AMODE 24. This combination forces the TRUE *always* to run AMODE 24, which is unwise because:

- An AMODE 24 TRUE cannot be invoked from a transaction running with TASKDATALOC(ANY). This results in an 'AEZB' abend.
- Enabling an AMODE 24 TRUE for task start causes CICS to force all transactions to run with TASKDATALOC(BELOW).
- On a CICS termination call, CICS ignores LINKEDITMODE and invokes the TRUE in AMODE 31, if it detects that the TCA it is running under is above the 16MB line. (This is because, for some types of termination, such as a cancel, the TCA under which the TRUE will run is not predetermined.)

It is recommended that TRUEs are:

- Written so that they can always run AMODE 31
- Link-edited AMODE 31
- Enabled with the LINKEDITMODE option.

If the task-related user exit has not been enabled with the LINKEDITMODE option of EXEC CICS ENABLE, it is invoked in the AMODE of the caller. For example, in the case of an application request, if the application is AMODE 24 at the time of the

DFHRMCAL, the task-related user exit is invoked in AMODE 24. For this reason, task-related user exits which have been enabled without the LINKEDITMODE option must reside below the 16MB line.

## Exit programs and the CICS storage protection facility

When you are running CICS with the storage protection facility, there are two points you need to consider for task-related user exits:

1. The execution key in which your task-related user exit programs run
2. The storage key of data storage obtained for your exit programs.

### Execution key for task-related user exit programs

When you are running with storage protection active, CICS always invokes task-related user exit programs in CICS key. Even if you specify EXECKEY(USER) on the program resource definition, CICS forces CICS key when it passes control to the TRUE. However, if a task-related user exit program itself passes control to another program (via a link or transfer-control command), the program thus invoked executes according to the execution key (EXECKEY) defined in its program resource definition.

### Important

You are strongly recommended to specify EXECKEY(CICS) when defining both task-related user exit programs, and programs to which an exit program passes control.

### Data storage key for task-related user exit programs

The storage key of storage used by task-related user exit programs depends on how the storage is obtained:

- Global or local work areas specified when an exit program is enabled, are always in CICS key.
- Any working storage obtained for the exit program is in the key set by the TASKDATAKEY of the transaction under which the exit program is invoked.
- Task-related user exit programs can use EXEC CICS commands to obtain storage by issuing:
  - Explicit EXEC CICS GETMAIN commands
  - Implicit storage requests as a result of EXEC CICS commands that use the SET option.

The default storage key for storage obtained by EXEC CICS commands is set by the TASKDATAKEY of the transaction under which the exit program is invoked.

## Recursion within a task-related user exit program

The task-related user exit has the ability to invoke itself recursively. It can do this, for example, by issuing a DFHRMCAL call to its own entry name (as specified on the EXEC CICS ENABLE command). It can also be entered recursively if it performs an EXEC CICS SYNCPOINT when it is interested in SYNCPOINT invocations.

## Purging tasks

The operation of task purging when control is within a task-related user exit depends on the PURGEABLE option on the EXEC CICS ENABLE PROGRAM command.

If the PURGEABLE option is *not* specified:



- Before passing control to a task-related user exit program, CICS inhibits:
  - The ability to purge tasks
  - The monitoring of runaway tasks
- While control is in a task-related user exit program:
  - Purge requests are deferred until control is returned from the task-related user exit program.
  - Monitoring of runaway tasks is inactive.
  - Force purge requests are actioned.

If the PURGEABLE option *is* specified, before passing control to a task-related user exit program CICS inhibits the monitoring of runaway tasks but not the ability to purge tasks. While control is in a task-related user exit program:

- Purge requests are actioned.
- Force purge requests are actioned.
- Monitoring of runaway tasks is inactive.

See “Wait states in your task-related user exit program” on page 292 for a fuller explanation of the PURGEABLE option.

## Using CICS services in your task-related user exit program

You might find some CICS services useful in your exit program. These can be invoked using EXEC CICS commands. However, you should take note of the following:

- If your program is invoked because of a CICS abend, it must not use any CICS services. See “Coding a program to be invoked at CICS termination” on page 298.
- EXEC CICS commands that cause an XCTL (either directly or implied)—for example, EXEC CICS XCTL or EXEC CICS SHUTDOWN—must never be used.
- DFHEIENT and DFHEIRET must be in your program. *But see the note about not using DFHEIENT in abend invocations, in “Limitations” on page 298.* For further details of the DFHEIENT and DFHEIRET macros, see DFHECALL macro, in the *CICS Application Programming Reference* manual.
- If your exit program entry point is immediately followed by an occurrence of a DFHEIENT macro, inserted either implicitly by CICS or explicitly in the program, then the expansion of the DFHEIENT macro stores incorrect values at DFHEIBP and DFHEICAP. Your code can subsequently correct this by copying UEPEIB into DFHEIBP, reloading the EIB base register (DFHEIBR) from UEPEIB, and setting DFHEICAP to X'80000000'. For example,

```
TESTPROG DFHEIENT CODEREG=2,EIBREG=11,DATAREG=10
          USING DFHUEPAR,1
          MVC  DFHEIBP,UEPEIB           Get correct EIB address
          L   DFHEIBR,UEPEIB           Reload EIB base register
          MVC  DFHEICAP,=X'80000000'
```

Note that the entry point of a program does not have to be at the start of the program and can be positioned after the DFHEIENT macro.

- The DFHEIENT macro allocates dynamic storage to be mapped by the DFHEISTG DSECT. You must return to CICS by means of the DFHEIRET macro, which frees the dynamic storage.
- Command-level calls use registers 0, 1, 14, and 15.
- Do not issue a syncpoint in start-of-task, end-of-task, or syncpoint invocations.

- On each invocation of a task-related user exit program, a new EXEC environment is created, even when the program is being invoked from the same task. This means that CICS operations, such as browse of a resource definition table, cannot be continued from one invocation of the exit program to the next.

## Using channels and containers

Task-related user exit programs cannot access channels and containers created by application programs. They can, however, create their own channels and pass them to programs which they call.

For information about channels and containers, see Enhanced inter-program data transfer: channels as modern-day COMMAREAs, in the *CICS Application Programming Guide*.

## Assembler programs and LEASM

Assembler programs translated with the LEASM option cannot be used as task-related user exit programs.

LEASM is used to produce Language Environment conforming main programs in assembler. For information about the LEASM translator option, see LEASM, in the *CICS Application Programming Guide*.

## Wait states in your task-related user exit program

By default, tasks that are active in a task-related user exit and have entered a CICS wait state cannot be purged—only force purge can be used. However, if a task-related user exit is enabled with the PURGEABLE option, a task can be successfully purged from a wait within the task-related user exit. If this option is to be used, the task-related user exit program must be written to process correctly a purged response from the wait. See ENABLE PROGRAM, in the *CICS System Programming Reference* manual for more information.

## Work areas

When you use the EXEC CICS ENABLE command to identify a task-related user exit program to CICS, you may specify that the program must have access to one local and one global work area. The EXEC CICS ENABLE command allows you to specify the size, in bytes, of the work areas to be acquired for your task-related user exit program. CICS acquires storage for the areas and initializes pointers to them. The user exit parameter list, DFHUEPAR, gives you access to the pointers. For more information, see the description of DFHUEPAR under “User exit parameter lists” on page 273.

### The global work area

A global work area is associated with an exit program. Whenever the exit program is invoked, it has access to the area through the parameter UEPGAA of DFHUEPAR. The global work area may be shared by a number of exit programs. You must have specified the size of the global work area using the GALENGTH parameter or the GAENTRYNAME parameter of the EXEC CICS ENABLE command.

The global work area is located below the 16MB line.

## The local work area

A local work area is associated with a single task and lasts only for the duration of the task. It is for the use of a single task-related user exit program. It can be thought of as a logical extension to the transaction work area (TWA, TWACOBAs) that is exclusively for the exit program's use. It is specified using the TALENGTH option of the EXEC CICS ENABLE command and is accessed using the UEPTAA parameter of DFHUEPAR.

If the TRUE is enabled with the LINKEDITMODE option of the EXEC CICS ENABLE command and link-edited AMODE 31, local work areas are located above the 16MB line; otherwise, they are below the line.

## Coding a program to be invoked by the CICS SPI

If you enable your task-related exit program with the SPI option of the EXEC CICS ENABLE PROGRAM command (or your program “expresses interest” in SPI calls by setting the SPI bit-mask in the schedule flag word), your program is invoked to satisfy EXEC CICS INQUIRE EXITPROGRAM commands that query whether the exit program is connected to its resource manager, and its entryname-qualifier. (For information about the INQUIRE EXITPROGRAM command, see INQUIRE EXITPROGRAM, in the *CICS System Programming Reference* manual.)

When invoked for SPI calls, your exit program should:

- Indicate whether it is connected to its external resource manager, by returning the appropriate value in the first field addressed by the caller's parameter list. The equated values are:

### UERTCONN

(X'80') The exit is connected to its resource manager.

### UERTNCONN

(X'40') The exit is not connected to its resource manager.

- Return the resource manager qualifier—that is, the entryname-qualifier, as returned by the UEPRMQUA parameter of an API call, and used on an EXEC CICS RESYNC command—in the second field addressed by the caller's parameter list.

Typically, both the above pieces of information are kept in the exit program's global work area. The caller parameter list for SPI calls is described in “CICS SPI parameters” on page 279.

The RMI SPI call allows a task-related user exit to be called by long-running monitor tasks, even if it has been disabled and reenabled since it was last called by the task. (All other types of RMI call fail if this is the case.)

**Note:** When invoked for an SPI call, your exit program should not rely on the contents of the task local work area. If the exit has been disabled and reenabled, a new version may have been loaded, which may have a different mapping of the task local work area. The long-running task, however, is running with the original task local work area allocated to it on its first call.

## Coding a program to be invoked by the CICS syncpoint manager

All task-related user exit programs can be invoked by the CICS syncpoint manager. An exit program must “schedule” the syncpoint manager by setting the syncpoint manager bit-mask in the schedule flag word. The bit-mask must be set after every

piece of recoverable work to ensure that the CICS syncpoint manager calls the exit program during syncpoint processing. (The identification of the current unit of recovery—or unit of work—is addressed by the 8-byte field UEPURID. This is available on all invocations of your exit program in which recoverable actions are possible, for example, application calls and subsequent syncpoint manager calls.)

### **Increasing efficiency – single-update and read-only protocols**

If your resource manager is capable of performing a single-phase commit, you can increase the efficiency of your system by means of CICS single-update and read-only protocols.

**Single-update protocol:** Many CICS transactions use only one external resource manager. In this case, a single-phase commit is in order. The benefits of a single-phase commit are:

- The resource manager can reduce from two to one the number of log forces required for transactions.
- The number of transaction-related log records written by CICS is reduced.
- A path length reduction is achieved, because the TRUE is invoked only once at the syncpoint, rather than twice.

To take advantage of these benefits, your task-related user exit program must indicate to CICS that the resource manager understands the single-update protocol, and that it (the TRUE) can process a syncpoint call to perform a single-phase commit. It indicates this by setting the UEPSUPDR flag in the field pointed to by UEPSYNCA in the DFHUEPAR parameter list. It must do this every time it sets the syncpoint manager bit in the schedule flag word.

If the exit program has set the UEPSUPDR flag, then, when the syncpoint manager next invokes the TRUE, it informs it whether the resource manager is the only one to have updated resources in the current UOW. It does this by means of the UERTONLY bit (in operation byte 2 of the syncpoint manager's parameter list); if this is set on, then the resource manager can be asked to perform a single-phase commit.

**Read-only protocol:** Similar gains in efficiency can be made if the resource manager is in read-only mode throughout the current UOW. Again, a single-phase commit is in order. To benefit, the resource manager must return to the TRUE a flag indicating whether the UOW is read-only or not. The flag may show either the "history" of the UOW so far (for example, so far it is read-only), or simply whether the current request is read-only. In turn, the TRUE must update the UEPREADO flag in the DFHUEPAR parameter list with the history of the UOW so far. That is, it must set UEPREADO initially, but unset it as soon as the UOW contains updates. (Once UEPREADO has been unset, CICS ignores any subsequent setting of the flag during the current UOW, and treats the UOW as containing updates.)

At the end of the UOW, if the UEPREADO flag is still set, the syncpoint manager invokes the TRUE with instructions to issue a single-phase commit to the resource manager (by setting the UERTELUW bit on).

### **Return codes**

When a task-related user exit program is invoked by the CICS syncpoint manager, the return codes it is able to set depend on the reason for the invocation. Table 15 on page 295 shows the relationship between the request flags in the syncpoint

manager's parameter list and the TRUE return codes. (The CICS syncpoint manager parameters are described in "CICS syncpoint manager parameters" on page 279.)

*Table 15. Valid return codes for a TRUE invoked by the CICS syncpoint manager*

Request-type	Return codes	Meaning
UERTPREP	UERFPREP	Phase 1 of 2-phase commit successful
UERTPREP	UERFBACK	Phase 1 of 2-phase commit unsuccessful
UERTWAIT	None	Not applicable
UERTCOMM	UERFDONE	Phase 2 of 2-phase commit successful
UERTCOMM	UERFHOLD	Phase 2 of 2-phase commit unsuccessful
UERTBACK	UERFDONE	Backout successful
UERTBACK	UERFHOLD	Backout unsuccessful
UERTONLY	UERFOK	Single-phase commit successful
UERTONLY	UERFBOUT	Single-phase commit failed and backed out
UERTELUW	None	Not applicable

### **What is expected of your resource manager**

If every request from the syncpoint manager prompts a meaningful response from the resource manager, CICS ensures that changes to recoverable resources (such as databases) can be synchronized. That is, either all the changes take effect or all are backed out, even across system failures.

### **Limitations**

Do not update a recoverable CICS resource during a syncpoint call because any changes will not be seen by the CICS syncpoint manager.

### **Sample code for a TRUE invoked by the CICS syncpoint manager**

The pseudocode given in Figure 8 on page 296 is only an example. It is not complete, and includes only some of the conditions that a task-related user exit invoked at a syncpoint might be required to check.

```

if UERTFID = UERTSYNC then      /* Caller is CICS syncpoint manager */
select;                          /* Type of syncpoint manager request */
  when (UERTONLY)                /* ONLY resource manager */
    invoke RM for single-phase commit /* Single-phase commit */
    if RM single-phase commit succeeded then
      give CICS syncpoint manager 'YES' vote (UERFOK)
    else                          /* Single-phase commit failed */
                                  /* If RM completed backout */
      if RM single-phase commit failed and backed out
        give CICS syncpoint manager 'NO' vote (UERFBOUT)
      else                          /* Don't know what happened */
        put out message and issue transaction abend
      endif
    endif
  when (UERTELUW)                /* RM read-only for current UOW */
    invoke RM for single-phase commit /* Single-phase commit */
  when (UERTPREP)                /* Not ONLY resource manager, nor read-only */
    invoke RM for PREPARE /* Prepare - phase 1 of 2-phase commit */
    select (resource manager vote)
      when (YES)                  /* Phase 1 completed */
        give CICS syncpoint manager 'YES' vote (UERFPREP)
      otherwise
        give CICS syncpoint manager 'NO' vote (UERFBACK)
    endselect
  when (UERTCOMM)                /* Commit - phase 2 of 2-phase commit */
    invoke RM for commit phase 2
    if RM commit succeeded then
      tell CICS sync manager OK (UERFDONE)
    else
      tell CICS sync manager remember could not commit (UERFHOLD)
    endif
  when (UERTBACK)                /* Backout request */
    invoke RM for backout
    if RM backout succeeded then
      tell CICS sync manager OK (UERFDONE)
    else
      tell CICS sync manager remember could not backout (UERFHOLD)
    endif
  when (UERTWAIT)                /* CICS in-doubt about UOW */
    invoke RM to free thread
    (but maintain locks for UOW and record UOW is in-doubt)
endselect
endif

```

Figure 8. Sample pseudocode for a task-related user exit program to be invoked by the CICS syncpoint manager

As described in “Increasing efficiency – single-update and read-only protocols” on page 294, if the UERTONLY bit is set (indicating that the resource manager is the only one to have updated resources) the exit program should cause the resource manager to perform a single-phase commit. If the commit is successful, the exit program should return ‘UERFOK’ in register 15; if not, it should return ‘UERFBOUT’, meaning that the commit was unsuccessful and the resources were backed out. If the exit program is unsure about the outcome of a single-phase commit, it must abend the task, having saved or displayed any diagnostic information that it considers necessary.

Note that “register 15” in this section refers to the syncpoint manager’s register 15, the fifth word of the area addressed by UEPHMSA.

Similarly, when the UERTELUW bit is set (indicating that the resource manager was in read-only mode throughout this UOW), the exit program should cause the resource manager to perform a single-phase commit. There are no return codes for a UERTELUW call. Because no updates were made, data integrity is not at risk, and therefore no action is taken if the commit fails.

On receiving a request to perform the first phase of a two-phase commit, the resource manager is expected to get into a state where recoverable changes made since the last syncpoint can be either committed or backed out on demand, even if there is an intervening system failure. For example, buffer contents must be moved to nonvolatile storage. If the resource manager is unable to get into this state, the exit program should return 'UERFBACK' in register 15, to request backout. Normally, it should return 'UERFPREP', to indicate a successful phase 1 of a 2-phase commit.

On receiving a request to wait (indicating that CICS is in-doubt about the outcome of the UOW), the resource manager should free any task-related resources, such as the thread. However, it should maintain any locks held by the UOW, and record that the UOW is in-doubt. See "Enabling for specific invocation-types" on page 303.

On receiving a request to perform the second phase of a two-phase commit, or a request to back out, the resource manager should take the corresponding irreversible step, and have the exit program send the syncpoint manager a return code: either 'UERFDONE', meaning that the commit or abend process is complete; or 'UERFHOLD', meaning that the commit or abend must be resolved later. These return code constants are available to you when you code the macro DFHUEXIT TYPE=RM in your exit program.

If a resource manager cannot understand a call, it should not change the contents of the caller's register 15 before returning to the caller, because it cannot anticipate how the caller will interpret the change.

### **Resynchronization**

If a failure occurs between returning from the exit after performing phase 1 of a 2-phase commit and the subsequent phase 2 or back out call, the resource manager must be ready, on restart, to discover the state of the unit of recovery, and to act accordingly. For programming information about restart resynchronization using the EXEC CICS RESYNC command, see RESYNC ENTRYNAME, in the *CICS System Programming Reference* manual.

If CICS is in-doubt about a unit of work, it sends the exit program a request to wait (UERTWAIT). When the status of the in-doubt UOW is resolved, CICS initiates a resynchronization task, to inform the exit program of the outcome of the unit of work.

Information about in-doubt units of work is retained across both warm and cold starts of CICS. CICS initialization and keypoint management routines recover from the system log all information associating resource managers with outstanding units of recovery, which are resolved automatically when CICS reconnects to the resource managers concerned.

## **Coding a program to be invoked by the CICS task manager**

If your exit program sets the task manager bit in the schedule flag word, it is invoked at end-of-task. If you specify TASKSTART on the EXEC CICS ENABLE command for the TRUE, it is invoked at start-of-task, and (providing it does not unset the task manager bit), at end-of-task too. To determine whether a particular invocation is at start- or end-of-task, you can examine the CICS task manager parameters described in "CICS task manager parameters" on page 282. Typically, your program shows interest in task manager events if it needs to save task-related information, such as performance or accounting data, before the task ends.

## Limitations

If your exit program is invoked at end-of-task, you must be alert to possible limitations on exit program activity at task-detach. For example:

- Do not update any CICS resources at all during a task-detach exit call, because the CICS syncpoint manager is not invoked again for that task. Note also that all resources (terminals, and so on) except task-storage have been released by end-of-task.

**Note:** You should also be aware that transactions with resource security or command security defined may not run successfully after the terminal has been released. See the *CICS RACF Security Guide* to determine which resources and commands are subject to security checking. Failure to observe these limitations can result in an ABENDAEY7 - NOTAUTH condition arising.

- It is possible to schedule a new CICS task from your exit program using the EXEC CICS START command and to pass data to a new task. However, you should note that EXEC CICS START uses a temporary storage queue to pass data to the new transaction. If this queue is recoverable (DFHTST TYPE=RECOVERY), it is locked to the detaching task. It is never unlocked, because, when the task-detach exit call is made, the resources of the detaching task have **already** been freed. Use of the PROTECT option would cause a different problem: the new task could not be scheduled until the next syncpoint of the detaching task, but there will be no such syncpoint.
- It is recommended that you do not access remote resources using a task-related user exit program. However, if you do so, then you must understand fully the circumstances in which the function shipping conversation may be terminated.

## Coding a program to be invoked at CICS termination

If you specify the SHUTDOWN option when enabling your task-related user exit program, it is invoked at system termination. The CICS system termination manager passes the exit program the address of a one-byte code that identifies the type of termination (see “CICS termination manager parameters” on page 282). You can use this invocation of your program to do processing appropriate to the type of termination. For example, at an orderly shutdown you could use it, rather than a PLT program, to shut down the adapter; at a CICS abend you could use it to take special actions, related to the seriousness of the abend.

### Limitations

Note that, due to the nature of CICS abends and operator cancels, there is no guarantee that CICS will be able to invoke your exit program at system termination, even if you have specified SHUTDOWN; it may be too impaired to do so.

The limitations on what your program can do, if invoked, depend on the type of termination:

#### Orderly shutdown (UERTCORD)

Your exit program must follow the rules for programs that execute during the first quiesce stage of CICS shutdown—that is, all CICS services are available, but programs must not start any new tasks.

#### Immediate shutdown (UERTCIMM)

As for orderly shutdown, except that your exit program should do the minimum required and return control, so that shutdown can proceed.



**CICS abend, retry possible, TCBs dispatchable (UERTCABY)**

MVS has flagged the failure as being “eligible for retry”. Your exit program must follow the MVS rules for this type of failure, documented in the *OS/390 MVS Authorized Assembler Services Guide*.

Subtasks in the region (that is, task control blocks (TCBs) in addition to the CICS job-step TCB) are still dispatchable, and your exit program can execute code under them.

You must not use any CICS services.

**CICS abend, retry not possible, TCBs dispatchable (UERTCABN)**

MVS has flagged the failure as “not eligible for retry”. Your exit program must follow the MVS rules for this type of failure. Note that your exit program is invoked from code within the CICS extended subtask abend exit (ESTAE). MVS imposes more restrictions on ESTAE code than on non-ESTAE code.

Subtasks in the region are still dispatchable, and your exit program can execute code under them.

You must not use any CICS services.

**CICS abend, retry not possible, TCBs not dispatchable (UERTOPCA)**

As for UERTCABN, except that subtasks in the region are **not** dispatchable; your exit program must not try to execute code under any TCBs that it may have attached.

**Important**

In the abend invocations (UERTCABY through UERTOPCA), your exit program must not use any CICS services. This includes the DFHEIENT call, which performs a CICS GETMAIN. To prevent a DFHEIENT call being issued automatically on each invocation of your program, specify the NOPROLOG translator option; but include in the program source your own DFHEIENT call to be issued on non-abend invocations only. An example of how to code a task-related user exit program to be invoked at CICS termination is given in Figure 9 on page 300. For further information about coding a DFHEIENT call, see DFHECALL macro, in the *CICS Application Programming Reference* manual.

**Sample code for a TRUE invoked at CICS termination**

Note that the sample in Figure 9 on page 300 is a multipurpose program—that is, it is coded to be invoked at many task-related user exit invocation points. However, to avoid the need to test for CICS abends in all of your multipurpose TRUES, it is recommended that you use a separate program for termination invocations.

```

JTRUE1A  CSECT          TERMINATION TRUE ENTRYPOINT
        STM  14,12,12(13)  Save registers
        USING JTRUE1A,R3
        LR   R3,R15        Use R3 as base register
        USING DFHUEPAR,R1  Address DFHUEPAR parameter list
        L    R2,UEPEXN
        USING DFHUERTR,R2
        CLI  UERTFID,UERTCTER  CICS Termination call?
        BNE  CONT          No, so continue
        L    R10,UEPHMSA     Address Host register save area
        USING SA,R10
        L    R5,RSAR1        Get Caller's R1
        USING DFHCTERM,R5
        L    R5,CTERML       Get termination type
        USING CTERMLIST,R5
        TM   CTERMTYPE,UERTCORD  CICS orderly shutdown?
        BO   CONT          Yes, so can use CICS services
        TM   CTERMTYPE,UERTCIMM  CICS immediate shutdown?
        BO   CONT          Yes, so can use CICS services
*
*   ...
*
*   Insert code here for any processing when CICS is abending
*   (No CICS services should be used)
*
*   ...
*
        LM   14,12,12(13)    Restore caller's registers
        BSM  0,14           Return to caller
CONT     DS   0H           Continue in new CSECT
        LM   14,12,12(13)    Restore callers's registers
        DROP R3
        USING JTRUE1A,R15    Use R15 as temporary base register
        L    R15,=V(JTRUE1B)  Get address of new CSECT
        BR   R15           Branch to new CSECT
        DROP R15
        LTORG
JTRUE1B  CSECT          POST TEST CSECT
        DFHEIENT
        LR   R4,R1          Use R4 to address parm list
        USING DFHUEPAR,R4    Address parm list
        L    R5,UEPEXN
        USING DFHUERTR,R5
        MVC  DFHEIBP,UEPEIB
        MVC  DFHEICAP,=X'80000000'
*
*   .....
*   Insert code here for all types of call other than when CICS
*   is abending
*   (CICS services can be used)
*
*   .....
EXIT     DS   0H
        DFHEIRET
*
        LTORG
*
DFHCTERM DSECT
CTERML  DS   A
*
CTERMLIST DSECT
CTERMTYPE DS  CL1
*

```

Figure 9. Sample code for a task-related user exit program to be invoked at CICS termination (part 1)

```

DFHEISTG DSECT
*
*      Local working storage for CSECT JTRUE1B
*
RSA    DS    18F                Register save area
SA     DSECT                Register save area DSECT
      DS    F
*
RSACB  DS    F      +004
RSACF  DS    F      +008
RSAR14 DS    F      +00C
RSAR15 DS    F      +010
RSAR0  DS    F      +014
RSAR1  DS    F      +018
RSAR2  DS    F
RSAR3  DS    F
RSAR4  DS    F
RSAR5  DS    F
RSAR6  DS    F
RSAR7  DS    F
RSAR8  DS    F
RSAR9  DS    F
RSAR10 DS    F
RSAR11 DS    F
RSAR12 DS    F
DFHREGS
DFHUEXIT TYPE=RM
DFHEISTG
DFHEIEND
PRINT NOGEN
PRINT GEN
END

```

Figure 10. Sample code for a task-related user exit program to be invoked at CICS termination (part 2)

## Using EDF with your task-related user exit program

If your exit program sets the EDF bit in the schedule flag word and EDF is active, the exit program is invoked before and after each API request to format screens for EDF to display.

Communication between the task-related user exit and EDF is controlled by the task-related user exit interface. The command flow between this interface, EDF, and the task-related user exit is summarized in Figure 11 on page 302.

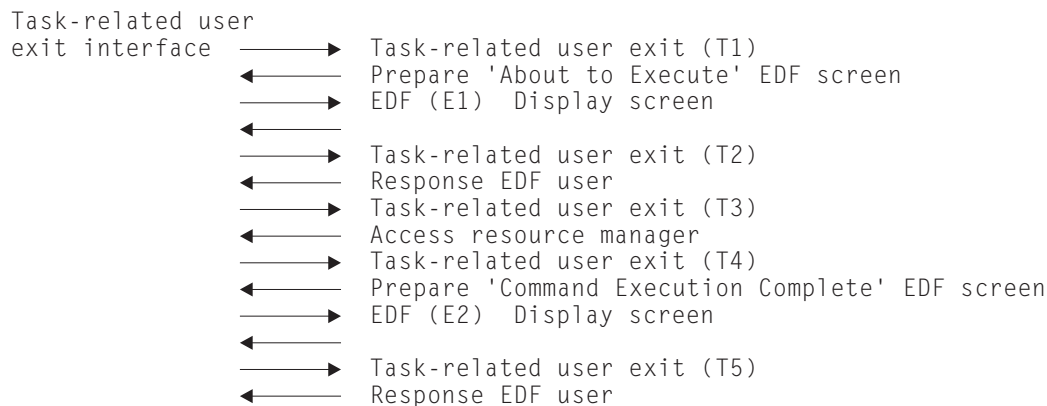

Figure 11. Interface between the task-related user exit and EDF

Table 16 describes each stage of the interface between the task-related user exit and EDF, relating the descriptions to the (Tn) and (En) expressions in Figure 11.

Table 16. Description of each stage of the task-related user exit/EDF interface

Invocation	Description
(T1)	Task-related user exit invoked to set up its EDF requirements. At this stage the task-related user exit prepares the “About to Execute” screen based on the application request.
(E1)	Using information passed back from the task-related user exit at invocation T1, the task-related user exit interface invokes EDF to display the “About to Execute” screen. EDF sets up the EDF user response, for example, if the user has changed the screen.
(T2)	Task-related user exit is invoked with the EDF user response to the “About to Execute” screen.
(T3)	Task-related user exit invoked to access external resource manager for application request.
(T4)	Task-related user exit invoked to prepare a “Command Execution Complete” screen, based on the result of the application request.
(E2)	Using information passed back from the task-related user exit at invocation T4, the task-related user exit interface invokes EDF to display the “Command Execution Complete” screen. EDF sets up the EDF user response, for example, if the user has changed the screen.
(T5)	Task-related user exit is invoked with the EDF user response to the “Command Execution Complete” screen.

### Important

The E1/T2 and E2/T5 cycles can be used repeatedly. This may occur, for example, if the EDF user changes the screen a number of times.

---

## Administering the adapter

Careful use of task-related user exits can allow your application programmers to be unaffected by the invocation of non-CICS resource managers from CICS application programs. Enabling and disabling task-related user exit programs for an installation should be the responsibility of one or more supervisory or master terminal

operators. This section lists what you must do before you can use the adapter, and describes the commands used by the supervisor to administer task-related user exit programs.

## What you must do before using the adapter

A task-related user exit program must be both enabled and started before it is available for execution.

1. Use the CEDA INSTALL PROGRAM command to define the task-related user exit program to the system.
2. Use the EXEC CICS ENABLE command to enable the task-related user exit program and to define its working storage needs.

```
EXEC CICS ENABLE PROGRAM('EP9')
      TALENGTH(750) GALENGTH(200) SHUTDOWN
EXEC CICS ENABLE PROGRAM('EP9')
      START
```

The first command loads the task-related user exit program, EP9, and causes a 200-byte work area to be obtained and associated with it. The first command also schedules the allocation of a further 750-byte work area for each task that subsequently invokes EP9, and for the invocation of EP9 at CICS termination. The second command starts the exit program: that is, it makes its entry point capable of being invoked.

### Enabling for specific invocation-types

Use the following options of the EXEC CICS ENABLE command to cause your exit program to be invoked at specific events:

#### INDOUBTWAIT

specifies that, at phase 2 syncpoint time, if CICS is in-doubt about the outcome of the UOW, the exit program is to be invoked with the UERTWAIT verb (wait), instead of a forced definition of UERTCOMM (commit) or UERTBACK (backout). UERTWAIT signifies that CICS does not yet know the outcome of the UOW. In response to a UERTWAIT call, the task-related user exit should invoke its resource manager to free any task-related resources, such as the thread. However, the resource manager should maintain any locks held by the UOW, and record that the UOW is in-doubt.

When CICS receives the outcome of the UOW from its coordinator, a resynchronization task is attached to notify the task-related user exit about the outcome of the UOW.

If CICS is in-doubt about the outcome of a UOW for which an external resource manager has requested resynchronization (using the EXEC CICS RESYNC command), CICS waits until the in-doubt has been resolved before initiating a resynchronization task.

The effects of **not** enabling a task-related user exit with the INDOUBT keyword are:

- If CICS is in-doubt about a UOW, a forced decision is taken and the task-related user exit invoked with the forced decision.
- If CICS is forced to take a decision because a task-related user exit is not enabled with INDOUBTWAIT, it takes a forced decision for **all** resources updated by the UOW, even if all the other resources are

capable of waiting for in-doubt resolution. This applies to local resources such as files, and also other RMCs, such as LU6.1, LU6.2, or MRO connections to other systems.

- An inbound RESYNC command from a resource manager that requests resynchronization for a UOW that CICS was in-doubt about, results in CICS invoking the task-related user exit with a forced decision.

#### **SHUTDOWN**

specifies that the exit program is to be invoked at CICS shutdown.

**SPI** specifies that the exit program is to be invoked to satisfy EXEC CICS INQUIRE EXITPROGRAM calls that specify the CONNECTST or QUALIFIER options. Use this option to enable user programs to discover whether the exit program is connected to its resource manager, and what its entryname qualifier is.

**Note:** The exit program can set this option dynamically, by setting the UEFMSPI bit-mask in the schedule flag word.

For programming information about the EXEC CICS ENABLE PROGRAM command, refer to ENABLE PROGRAM, in the *CICS System Programming Reference* manual.

#### **The administration routines**

As well as being enabled before they can be used, task-related user exit programs should be disabled when you have finished using them. You should prepare procedures (the administration routines) for enabling and disabling your task-related user exit programs, using the EXEC CICS ENABLE and DISABLE commands, and for resynchronizing between sessions or after a system failure. Your enabling routines could be PLT initialization programs or online programs. Your disabling routines could, for example, be started by a TRUE invoked at CICS termination.

The EXTRACT EXIT command obtains the address and the length of a global work area that is owned by, or shared by, a named task-related user exit program.

For programming information about these system commands, and the rules governing them, and also about resynchronization, refer to the *CICS System Programming Reference* manual.

## **Tracing a task-related user exit program**

CICS outputs a trace entry just before control is passed to the task-related user exit and just after returning from the exit. You can control these trace entries using the RI option of the CETR trace control transaction or the EXEC CICS SET TRACETYPE command.

---

## Chapter 3. The user exit programming interface (XPI)

This chapter describes the user exit programming interface (XPI) of CICS Transaction Server for z/OS, Version 3 Release 2. It is divided into the following sections:

- “Overview of the XPI” is an introduction to the XPI.
- “Making an XPI call” on page 308 contains information that applies to all the XPI calls.
- “Global user exit XPI examples, showing the use of storage” on page 313 contains two pieces of sample code.
- “XPI syntax” on page 319 describes the syntax of the individual XPI calls. The calls are grouped according to the type of function they perform (for example, dump control, storage control). The functional groups are ordered alphabetically.

---

### Overview of the XPI

The user exit programming interface provides global user exit programs with access to some CICS services. It consists of a set of macro function calls that you can use in your user exit programs.

It provides opportunities to extend CICS functions beyond the facilities provided in the standard CICS system, but it must be used with care. Any exit programs you write that use the interface must be written following the guidance and they must be carefully tested to ensure that they cannot cause system errors.

The user exit programs must be in assembler language; the XPI is not provided for other languages. You should also note that programs containing XPI calls must be written to 31-bit standards, and must be reentrant.

You must be in primary-space translation mode when you invoke the XPI. (For information about translation modes, see *z/Architecture Principles of Operation*, SA22-7832.)

- Using the XPI directory functions, you can:
  - Establish a session with an LDAP server—see “The BIND\_LDAP call” on page 321
  - Terminate a session with an LDAP server—see “The UNBIND\_LDAP call” on page 330
  - Remove the contents of all cached search responses for the specified LDAP connection—see “The FLUSH\_LDAP\_CACHE call” on page 323
  - Send a search request to a specified LDAP server—see “The SEARCH\_LDAP call” on page 328
  - Browse the results (attributes or entries) returned by the SEARCH\_LDAP call—see “The START\_BROWSE\_RESULTS call” on page 329
  - Get the next attribute in a series, from an entry returned by the SEARCH\_LDAP call—see “The GET\_NEXT\_ATTRIBUTE call” on page 326
  - Get the next entry, from a series of entries returned by the SEARCH\_LDAP call—see “The GET\_NEXT\_ENTRY call” on page 327
  - Retrieve the value associated with an attribute returned by the SEARCH\_LDAP call—see “The GET\_ATTRIBUTE\_VALUE call” on page 325
  - End the browse session that was started by the START\_BROWSE\_RESULTS call—see “The END\_BROWSE\_RESULTS call” on page 323

- Release all storage held by the SEARCH\_LDAP function—see “The FREE\_SEARCH\_RESULTS call” on page 324.
- Using the XPI dispatcher functions, you can:
  - Obtain a suspend token for a task—see “The ADD\_SUSPEND call” on page 334
  - Suspend execution of the issuing task—see “The SUSPEND call” on page 335
  - Resume execution of a suspended task—see “The RESUME call” on page 339
  - Release a suspend token associated with a task—see “The DELETE\_SUSPEND call” on page 340
  - Request a wait on one or more MVS event control blocks (ECBs)—see “The WAIT\_MVS call” on page 340
  - Change the priority of the issuing task—see “The CHANGE\_PRIORITY call” on page 344.
- Using the XPI dump control functions, you can:
  - Request a system dump—see “The SYSTEM\_DUMP call” on page 345
  - Request a transaction dump—see “The TRANSACTION\_DUMP call” on page 347.
- Using the XPI enqueue domain functions, you can:
  - Enqueue on a named resource—see “The ENQUEUE function” on page 349
  - Release a resource previously enqueued by an ENQUEUE function call—see “The DEQUEUE function” on page 350.
- Using the XPI kernel domain functions, you can:
  - Inhibit purge for the current task—see “The START\_PURGE\_PROTECTION function” on page 351
  - Reenable purge for the current task—see “The STOP\_PURGE\_PROTECTION function” on page 351.
- Using the XPI loader functions, you can:
  - Define a new program to the loader domain—see “The DEFINE\_PROGRAM call” on page 353
  - Load a program or, if it is already loaded, obtain its load and entry-point addresses—see “The ACQUIRE\_PROGRAM call” on page 356
  - Release the storage occupied by a program, or decrement its use count by one—see “The RELEASE\_PROGRAM call” on page 358
  - Delete a program definition from the list of current programs—see “The DELETE\_PROGRAM call” on page 359.
- Using the XPI log manager functions, you can:
  - Retrieve information about the activity keypoint frequency of the system—see “The INQUIRE\_PARAMETERS call” on page 360
  - Set the activity keypoint frequency of the system—see “The SET\_PARAMETERS call” on page 361.
- Using the XPI monitoring functions, you can:
  - Process a user event-monitoring point—see “The MONITOR call” on page 362
  - Retrieve the current monitoring data for the issuing task—see “The INQUIRE\_MONITORING\_DATA call” on page 364.
- Using the XPI program management functions, you can:



- Inquire about the attributes of a specified program—see “The INQUIRE\_PROGRAM call” on page 366
- Inquire about the attributes of the program that is currently running—see “The INQUIRE\_CURRENT\_PROGRAM call” on page 373
- Set selected attributes in the definition of a specified program—see “The SET\_PROGRAM call” on page 375
- Browse through program definitions, optionally starting at the definition of a specified program—see “The START\_BROWSE\_PROGRAM call” on page 379, “The GET\_NEXT\_PROGRAM call” on page 380, and “The END\_BROWSE\_PROGRAM call” on page 381
- Inquire about the settings of the autoinstall function for programs, mapsets, and partitionsets—see “The INQUIRE\_AUTOINSTALL call” on page 382
- Change the settings of the autoinstall function for programs, mapsets, and partitionsets—see “The SET\_AUTOINSTALL call” on page 382.
- Using the XPI state data access functions, you can:
  - Inquire on application system data in the AP domain—see “The INQ\_APPLICATION\_DATA call” on page 384
  - Inquire on CICS system data in the AP domain—see “The INQUIRE\_SYSTEM call” on page 386
  - Set CICS system data values in the AP domain—see “The SET\_SYSTEM call” on page 391.
- Using the XPI storage control functions, you can:
  - Obtain and initialize storage—see “The GETMAIN call” on page 392
  - Release storage—see “The FREEMAIN call” on page 395
  - Inquire about the access-key of an element of storage—see “The INQUIRE\_ACCESS call” on page 395
  - Obtain the start address and length of an element of task-lifetime storage—see “The INQUIRE\_ELEMENT\_LENGTH call” on page 396
  - Discover whether CICS is short on storage—see “The INQUIRE\_SHORT\_ON\_STORAGE call” on page 397
  - Inquire about a task’s task-lifetime storage—see “The INQUIRE\_TASK\_STORAGE call” on page 398
  - Cause CICS to switch from a subspace to base space—see “The SWITCH\_SUBSPACE call” on page 399.
- Using the XPI trace control function, you can:
  - Write a trace entry to the active trace destinations—see “The TRACE\_PUT call” on page 400.
- Using the XPI transaction management functions, you can:
  - Inquire about the environment in which a transaction is running—see “The INQUIRE\_CONTEXT call” on page 401
  - Discover the name of the dynamic transaction routing transaction definition—see “The INQUIRE\_DTRTRAN call” on page 403
  - Discover the current value of the MXT system initialization parameter—see “The INQUIRE\_MXT call” on page 403
  - Inquire about a specified transaction class—see “The INQUIRE\_TCLASS call” on page 405
  - Inquire about a specified transaction definition—see “The INQUIRE\_TRANDEF call” on page 406

- Inquire about an attached transaction—see “The INQUIRE\_TRANSACTION call” on page 414
- Change the task priority and transaction class of the current task—see “The SET\_TRANSACTION call” on page 418.
- Using the XPI user journaling function, you can:
  - Write a record to a CICS journal—see “The WRITE\_JOURNAL\_DATA call” on page 419.

### Important

1. You cannot use all of the XPI calls at every global user exit point. You will find an indication of when these calls cannot be used both with the description of each function call, and in the lists of exit points in Chapter 1, “Global user exit programs,” on page 3.  
XPI calls are used to invoke CICS services; using them in the wrong exits causes unpredictable errors in your CICS system.
2. There is a restriction on using the XPI early during initialization. Do not start exit programs that use the XPI functions INQUIRE\_MONITOR\_DATA, MONITOR, TRANSACTION\_DUMP, and WRITE\_JOURNAL\_DATA until the second phase of the PLTPI. For further information about the PLTPI, refer to Chapter 4, “Writing initialization and shutdown programs,” on page 425.
3. These XPI functions are likely to cause the task executing the user exit program to lose control to another task while the XPI function is being executed. Therefore the use of XPI functions must be very carefully considered, as interrupting the flow of CICS functions could cause problems, such as lockouts, to occur.

---

## Making an XPI call

If you make an XPI call, it must be in the form described below. It consists of two sets of parameters:

- Input parameters, including the XPI function call and the parameters passed to the call
- Output parameters, by which CICS can return values to you, including response and reason codes that tell you whether the call was successful.

To use an XPI macro call, you must include a copy book that defines the input and output parameters. The name of the macro is always of the form DFHxxyyX, and the associated copy book has the name DFHxxyyY. For example, the GETMAIN call is part of the storage control XPI. The macro you would use is DFHSMMCX and the associated copy book is DFHSMMCX.

The general format (omitting the assembler-language continuation character) of all XPI calls is:

```
macro-name [CALL],
           [CLEAR],
           [IN,
           FUNCTION(call_name),
           mandin1(value),
           mandin2(value),
           ...
           [optin1(value),]
           [optin2(value),]
           ...]
           [OUT,
           mandout1(value),
```

```

mandout2(value),
...
[optout1(value),]
[optout2(value),]
...
RESPONSE,
REASON]

```

XPI calls follow assembler-language coding conventions:

- The “macro-name” must begin before column 16.
- The continuation lines must begin in column 16.
- There must be no embedded blanks apart from the blank between the macro-name and the first keyword (usually CALL).
- Entries on lines other than the final line must end with a comma.
- Lines other than the final line must have a continuation character in column 72.
- Parentheses around the input and output values are required—and if you use a register reference as an input or output value, it must be enclosed in an inner pair of parentheses, thus: ((R6)).
- For details about how to set the values of the XPI options, refer to “XPI syntax” on page 319.

There are three uses of these XPI functions. You can:

- Clear the parameter list used by the XPI call
- Set up the input parameters
- Make the call to the CICS function.

You can code all of these individually (see “An example showing how to build a parameter list incrementally” on page 318), or include them in a single statement.

Some options are common to all uses of the XPI. They are included in all of the syntax descriptions, but their explanation is given here. The options are CALL, CLEAR, IN, FUNCTION, OUT, RESPONSE, and REASON.

**CALL** causes code generation that issues a call to the XPI function. If you specify CALL, IN, FUNCTION, and OUT, then code is generated to perform the whole operation of building the parameter list, invoking the function, and receiving the result. You can omit the CALL, but specify IN to build your parameter list incrementally; later you can use CALL with that list, coding CALL, IN, FUNCTION, OUT, and all required options. You can then represent the values of the preset options by an asterisk (\*) to show that the value is already present in the list.

**Note:** If you build your parameter list incrementally, do not specify CLEAR when you finally issue the call, because the CLEAR option sets the parameter list to zeros, which will cause you to lose the preset values.

#### **CLEAR**

sets the existence bits in the parameter list (both mandatory and optional parameters) to binary zeros. Each macro has a COPY code, which defines the parameter list by a DSECT consisting of a header section, followed by a set of existence bits, and the parameters themselves. For performance reasons, the header section and the existence bits only are cleared. The rest of the parameter list is left unchanged.

**Note:** Failure to clear the parameter list can cause unpredictable results, such as program checks or storage violations. If you are building the parameter list incrementally, specify CLEAR before specifying any parameters. If you are not building the parameter incrementally, specify CLEAR when the CALL is issued.

**IN** tells CICS that any parameter following the IN option and preceding the OUT option is an input value. It **must** be specified when CALL is specified. If you use the function without CALL to build a parameter list, you can specify IN and some parameter values to store values into your list.

### FUNCTION

specifies which function of the macro you require; for instance, GETMAIN or FREEMAIN. It **must** be specified when CALL is specified, and unlike other options, it must always be explicit—you **cannot** code “FUNCTION(\*)”.

### mandin(value)

“mandin” represents an option that becomes mandatory if CALL is specified. “value” may be represented by an asterisk (\*) to show that a previous use of the macro has already set the value in the parameter list (see above under “CALL”). For further details about how to complete “value”, refer to the specific function calls in “XPI syntax” on page 319.

**OUT** tells CICS that any parameter following the OUT option is a receiver field. It **must** be specified when CALL is specified.

**Note:** The use of the following output parameters with values other than an asterisk (\*) is invalid if CALL is not specified.

### mandout(value)

“mandout” represents an option that becomes mandatory if CALL is specified. The output is placed in the parameter list if an asterisk (\*) is coded, or in the location that you have specified in “value”. RESPONSE is a special case of a mandout option (see below). For further details about how to complete “value”, refer to the specific function calls (see “XPI syntax” on page 319).

### optin1,2...; optout1,2....

represent items that are completely optional for **all** forms of the macro; in particular, they do not have to be specified when CALL is specified.

### RESPONSE

is a mandatory data area that you define to receive the response from your XPI call. You can use an asterisk (\*) to indicate to CICS that the RESPONSE value is to be placed in the parameter list, or you can specify the name of a field in which you want the RESPONSE value to be placed. You need not code the RESPONSE option if you are using the macro without CALL to build a parameter list.

The response from any XPI call is always one of ‘OK’, ‘EXCEPTION’, ‘DISASTER’, ‘INVALID’, ‘KERNERROR’, and ‘PURGED’. There are standardized names (EQU symbols) for the response code values provided by CICS:

xxyy\_OK, xxyy\_EXCEPTION, xxyy\_DISASTER, xxyy\_INVALID,  
xxyy\_KERNERROR, and xxyy\_PURGED,

where “xxyy” is a prefix derived from the four letters of the relevant macro-name following the string ‘DFH’. Thus for DFHSMCMX the prefix is SMMC; for DFHLDLDX the prefix is LDLD. Equate values with these names are generated when you include the copy book DFHxxyY for the macro

DFHxxyyX. You cannot assume that the arithmetic values of corresponding RESPONSE codes are the same for all macro calls. The meanings of the RESPONSE codes are as follows:

**OK** The XPI request was completed successfully.

**EXCEPTION**

The function was not completed successfully for a reason which could be expected to happen, and which may be coded for by a program (for example, TRANSACTION\_DUMP, EXCEPTION = SUPPRESSED\_BY\_DUMPTABLE). Any REASON value may provide more information.

**DISASTER**

The request has failed completely. You cannot recover from this failure within the user exit program. When this failure occurs, CICS takes a system dump, issues an error message, and sets a 'DISASTER' response. On receiving this, your user exit program should exit without attempting any further processing. The REASON value for this response, shown only in the trace, may provide more information. There is no REASON value returned to the calling program.

**INVALID**

You have omitted a mandatory value, or you have supplied an invalid value for an option. You cannot recover from this failure within the user exit program. When this failure occurs, CICS takes a system dump, issues an error message, and sets an 'INVALID' response. On receiving this response, your user exit program should return to the caller without attempting any further processing. The REASON value for this response, shown only in the trace, may provide more information. This may help you to correct any error in your exit program. There is no REASON value returned to the calling program.

**KERNERROR**

The kernel has detected an error with the CICS function you are trying to invoke. Either the function you have requested is unavailable or not valid, or there is an error within CICS.

**PURGED**

The task has been purged, or an interval specified on your XPI call has expired. Examine the REASON code.

Note that if an XPI call other than DFHDSSRX SUSPEND or WAIT\_MVS gets this RESPONSE, your exit program should set the return code to 'UERC PURG' and return to the caller.

If a DFHDSSRX SUSPEND or WAIT\_MVS call specifies an INTERVAL and gets this RESPONSE with a REASON of 'TIMED\_OUT', it indicates that the INTERVAL you specified has passed. It is up to you to decide what you do next.

If a DFHDSSRX SUSPEND or WAIT\_MVS call specifies an INTERVAL and gets this RESPONSE with a REASON of 'TASK\_CANCELLED', this indicates that the INTERVAL you specified has not passed but that the task has been purged by an operator or an application. In this case, you must set a return code of 'UERC PURG' and return.

If a DFHDSSRX SUSPEND or WAIT\_MVS call does **not** specify an INTERVAL, and gets this RESPONSE with a REASON of 'TASK\_CANCELLED' or 'TIMED\_OUT', it indicates that the task has been purged by an operator or an application, or by the deadlock time-out facility. In this case, you must set a return code of 'UERCPURG' and return.

You **must not** return the response code 'UERCPURG' to CICS for any other reason. If you attempt to do so, your program will have unpredictable results.

### REASON

This is a mandatory data area that you define in order to receive more information about the RESPONSE value. You can use (\*) to indicate to CICS that the REASON value is to be placed in the parameter list. On most XPI calls, standardized reason names (EQU symbols) are provided only for RESPONSE values of 'EXCEPTION' and 'PURGED'. The REASON values that accompany responses vary from one XPI function to another, so details are provided with the descriptions of the XPI calls.

REASON is not applicable where RESPONSE was 'OK'. In these circumstances, you should not test the REASON field.

**Note:** For examples of how to initialize the parameter list, set up parameters, make the call, and receive output parameters, refer to “Global user exit XPI examples, showing the use of storage” on page 313. That section includes both a complete example, and also an example in which each step is executed separately.

## Setting up the XPI environment

The exit programming interface (XPI) does not require the usual CICS transaction environment, but you do need to set up a special exit programming environment before you can use any XPI calls. If you are going to use any of the XPI functions in an exit program, you must include in your program, at a point **before** you issue any XPI calls, the macro:

```
DFHUEXIT TYPE=XPIENV
```

The expansion of this macro provides the DSECTs that are used in all XPI calls. It also provides a list of register equates (R0 EQU 0, R1 EQU 1, and so on), that you can use in your exit program. The other fields generated by the macro are used by CICS to perform the XPI call processing. You must not use any of these fields: if you do so, your user exit program will have unpredictable results.

The user exit program should be in 31-bit addressing mode.

## XPI register usage

Before you can issue an XPI call from a global user exit program, you **must** move the contents of the parameter UEPSTACK (the kernel stack entry) of DFHUEPAR to the exit program's register 13.

The XPI function expansion uses registers 0, 1, 14, and 15, so the exit program must save and restore them if necessary around an XPI call.

For an example of how to use EXEC CICS commands and XPI calls in the same exit program, see Appendix F, “The example program for the XTSEREQ global user exit, DFH\$XTSE,” on page 877.

## The XPI copy books

There is a copy book for each XPI function, to provide the DSECTs associated with that function. These DSECTs allow you to map the parameters and the response and reason codes of an XPI call. You must include in your exit program a COPY statement for each XPI function that you are going to use. The copy book name is the same as the macro name, except that the final letter “X” becomes a letter “Y”.

For example, to include the copy book for the XPI function DFHSMMCX, you must include the statement:

```
COPY DFHSMMCY
```

Trace entries for your XPI calls show these parameter lists if you have tracing on for the function you are using.

## Reentrancy considerations resulting from XPI calls

During an XPI call, CICS may give control to another task while processing the XPI call. This second task could also cause the same exit program to be invoked and the same XPI call to be made, but perhaps this time with different parameter values. **It is your responsibility to ensure that lockout situations do not occur.**

While processing an XPI call, CICS may encounter another user exit point that uses the same user exit program. Therefore the XPI parameter lists must be built in storage associated with a single invocation of the exit program.

If your exit program is a global user exit, CICS provides it with 320 bytes of LIFO storage, which is exclusive to a single invocation of your exit program. Your exit program can access this storage using parameter UEPXSTOR of the DFHUEPAR parameter list. Use this storage to base the DSECT provided by the DFHxxyyY copy book when building the XPI parameter list. In this way, the parameters are not corrupted if the exit program is reentered.

Parameter lists for the XPI services provided here do not exceed 256 bytes. The remaining 64 bytes of the UEPXSTOR storage can be used by your exit program for its own purpose. It is expected that the 64 bytes of spare storage will, in most cases, avoid the need for your exit programs to obtain more storage. If you do need to obtain more than the extra 64 bytes provided, obtain it by either a DFHSMMCX FUNCTION (GETMAIN) macro, or an MVS GETMAIN request.

Information to be kept across invocations of an exit program can be stored in the global work area that you can define for an exit program (or group of exit programs). The 320 bytes of LIFO storage cannot be used for this purpose because it is dynamic.

---

## Global user exit XPI examples, showing the use of storage

The example in Figure 12 on page 315 illustrates the use of the XPI and storage in a global user exit program. It is not a complete program, but merely an example of entry and exit code for any global user exit program, and the use of the XPI function.

The options of the DFHSMMCX macro used in the example are described in “Storage control XPI functions” on page 392.

The example uses the technique of obtaining some storage for this invocation of the program using the XPI GETMAIN call, and then saving the address of this storage

in the first 4 bytes of the LIFO storage addressed by UEPXSTOR. In this example, the initialization of the parameter list (using the CLEAR option), the building of the parameter list, and the GETMAIN call occur in a single macro. For details of how to build the parameter list incrementally, and how to separate the CLEAR and the GETMAIN call, refer to “An example showing how to build a parameter list incrementally” on page 318.



```

TITLE 'GUEXPI - GLOBAL USER EXIT PROGRAM WITH XPI'
*****
* The first three instructions set up the global user exit      *
* environment, identify the user exit point, prepare for the use of *
* the exit programming interface, and copy in the definitions that *
* are to be used by the XPI function.                            *
*****
*
*       DFHUEXIT TYPE=EP,ID=XFCREQ      PROVIDE DFHUEPAR PARAMETER
*                                       LIST FOR XFCREQ IN THE FILE
*                                       CONTROL PROGRAM AND LIST
*                                       OF EXITID EQUATES
*
*       DFHUEXIT TYPE=XPIENV           SET UP ENVIRONMENT FOR
*                                       EXIT PROGRAMMING INTERFACE --
*                                       MUST BE ISSUED BEFORE ANY
*                                       XPI MACROS ARE ISSUED
*
*       COPY DFHSMNCY                  DEFINE PARAMETER LIST FOR
*                                       USE BY DFHSMCX MACRO
*
*****
* The following DSECT maps a storage area you can use to make the *
* exit program reentrant by storing the address of the storage you *
* acquire in the first four bytes of the 260-byte area provided by *
* the user exit handler (DFHUEH) and addressed by UEPXSTOR.      *
*****
*
TRANSTOR DSECT                          DSECT FOR STORAGE OBTAINED BY
*                                       GETMAIN
*
*
*
storage declarations
*
*
*****
* The next seven instructions form the normal start of a global user *
* exit program, setting the program addressing mode to 31-bit, saving *
* the calling program's registers, establishing base addressing, and *
* establishing the addressing of the user exit parameter list.      *
*****
*
GXPI      CSECT
GXPI      AMODE 31                      SET TO 31-BIT ADDRESSING
*
*       SAVE (14,12)                    SAVE CALLING PROGRAM'S REGISTERS
*
*       LR   R11,R15                     SET UP USER EXIT PROGRAM'S
*       USING GXPI,R11                   BASE REGISTER
*
*       LR   R2,R1                       SET UP ADDRESSING FOR USER
*       USING DFHUEPAR,R2                EXIT PARAMETER LIST -- USE
*                                       REGISTER 2 AS XPI CALLS USE
*                                       REGISTER 1
*
*

```

Figure 12. Global user exit program with XPI (part 1)

```

*****
* Before issuing an XPI function call, set up addressing to XPI      *
* parameter list.                                                    *
*****
*
*       L       R5,UEPXSTOR           SET UP ADDRESSING FOR XPI
*
*       USING DFHSMC_ARG,R5          MAP PARAMETER LIST
*
*****
* Before issuing an XPI function call, you must ensure that register *
* 13 addresses the kernel stack.                                     *
*****
*
*       L       R13,UEPSTACK          ADDRESS KERNEL STACK
*
*****
* Issue the DFHSMCX macro call, specifying:                          *
*
* CALL --      the macro is to be called immediately                *
*
* CLEAR --     initialize the parameter list before inserting values.*
*
* IN --        input values follow.                                  *
*
*              FUNCTION(GETMAIN) -- acquire storage                 *
*              GET_LENGTH(120) -- 120 bytes of it                   *
*              SUSPEND(NO) -- don't suspend if storage not available *
*              INITIAL_IMAGE(X'00') -- clear acquired storage       *
*                               to hex zero throughout.            *
*              STORAGE_CLASS(USER) -- class of storage to be       *
*                               acquired is user storage            *
*                               above the 16MB line.                 *
*
* OUT --       output values follow                                  *
*
*              ADDRESS((R6)) -- put address of acquired storage in  *
*                               register 6.                          *
*              RESPONSE(*) -- put response at SMMC_RESPONSE in     *
*                               macro parameter list.               *
*              REASON(*) -- put reason at SMMC_REASON in macro     *
*                               parameter list.                      *
*****
*
*       DFHSMCX CALL,
*       CLEAR,
*       IN,
*       FUNCTION(GETMAIN),
*       GET_LENGTH(120),
*       SUSPEND(NO),
*       INITIAL_IMAGE(X'00'),
*       STORAGE_CLASS(USER),
*       OUT,
*       ADDRESS((R6)),
*       RESPONSE(*),
*       REASON(*)
*

```

Figure 13. Global user exit program with XPI (part 2)

```

*****
* Test SMMC_RESPONSE -- if OK, then branch round error handling.      *
*****
*
    CLI  SMMC_RESPONSE,SMMC_OK    CHECK RESPONSE AND...
    BE   STOK                     ...IF OK, BYPASS ERROR ROUTINES
*
    .
    .
    .
    error-handling routines
    .
    .
*****
* The next section maps TRANSTOR on the acquired storage.            *
*****
STOK    DS    0H
        USING TRANSTOR,R6          MAP ACQUIRED STORAGE
        ST    R6,0(R5)             SAVE STORAGE ADDRESS IN FIRST
*                                       4 BYTES OF STORAGE ADDRESSED
*                                       BY UEPXSTOR
*
        LA   R5,4(R5)              ADDRESS 4-BYTE OFFSET
        DROP R5                    REUSE REGISTER 5 TO BASE ALL
        USING DFHxxyy_ARG,R5       FOLLOWING XPI PARAMETER LISTS
*                                       AT 4-BYTE OFFSET INTO STORAGE
*                                       ADDRESSED BY UEPXSTOR
*
    .
    .
    .
rest of user exit program
    .
    .
    .
*****
* When the rest of the exit program is completed, free the storage   *
* and return.                                                         *
*****
*
        DROP R5                    REUSE REGISTER 5 TO MAP DFHSMMC
        USING DFHSMMC_ARG,R5       XPI PARAMETER LIST
*
        L    R13,UEPSTACK          ADDRESS KERNEL STACK
*
*****
* Issue the DFHSMMCX macro call, specifying:                          *
*
* CALL --      the macro is to be called immediately.                *
*
* CLEAR --     initialize the parameter list before inserting values. *
*
* IN --        input values follow.                                    *
*
*              FUNCTION(FREEMAIN) -- release storage                  *
*              ADDRESS((R6)) -- address of storage is in register 6. *
*              STORAGE_CLASS(USER) -- class of acquired storage was  *
*                                     31-bit user storage.             *
*

```

Figure 14. Global user exit program with XPI (part 3)

```

*   OUT --      output values follow                                     *
*                                                       *
*   RESPONSE(*) -- put response at SMMC_RESPONSE in macro parameter list. *
*                                                       *
*   REASON(*) -- put reason at SMMC_REASON in macro parameter list.      *
*                                                       *
*****
*
*   DFHSMMCX CALL,                                                     +
*   CLEAR,                                                             +
*   IN,                                                                  +
*   FUNCTION(FREEMAIN),                                                +
*   ADDRESS((R6)),                                                       +
*   STORAGE_CLASS(USER),                                                +
*   OUT,                                                                  +
*   RESPONSE(*),                                                         +
*   REASON(*)                                                             +
*
*****
* Test SMMC_RESPONSE -- if OK, then branch round error handling.      *
*****
*
*   CLI  SMMC_RESPONSE,SMMC_OK    CHECK RESPONSE AND...
*   BE   STEND                    ...IF OK, BYPASS ERROR ROUTINES
*
*
*   .
*   .
*   .
*   error-handling routines
*   .
*   .
*
*****
* Restore registers, set return code, and return to user exit handler *
*****
*
STEND  DS   0H
        L   R13,UEPEPSA
        RETURN (14,12),RC=UERCNORM
        LTORG
        END  GXPI

```

Figure 15. Global user exit program with XPI (part 4)

## An example showing how to build a parameter list incrementally

In the following example, the parameter list is built incrementally. The initialization of the parameter list (using the CLEAR option), the building of the parameter list, and the GETMAIN call are separated into discrete steps.

```

        DFHSMMCX CLEAR
        :
        :
        DFHSMMCX GET_LENGTH(100)
        :
        :
        DFHSMMCX CALL,
            IN,
            FUNCTION(GETMAIN),
            GET_LENGTH(*),
            SUSPEND(NO),
            INITIAL_IMAGE(X'00'),
            STORAGE_CLASS(USER),

```

OUT,	*
ADDRESS((R6)),	*
RESPONSE(*),	*
REASON(*)	

## Important

You must set your parameters using **only** the XPI functions.

---

## XPI syntax

The XPI functions use special syntax. The description of each function defines only the options that are specific to that call. Options that are applicable to all function calls are described in “Making an XPI call” on page 308. The following argument types are used:

### **name1, name2,....**

Each of these refers to the name of a field of the given size in bytes.

“name1” means that the name you specify should be that of a 1-byte field.

### **literalconst**

A number in the form of a literal, for example B'00000000', X'FF', X'FCF4', "0", or an equate symbol with a similar value.

### **expression**

A valid assembler-language expression: a decimal integer, or any arithmetic expression (including symbolic values) valid in assembler language; for example:

20; L'AREA; L'AREA+10; L'AREA+X'22'; SYMB/3+20 .

**(Rn)** A register reference. The parentheses shown here are required in addition to those that surround the argument. For example: OPTION((R5)).

### **block-descriptor**

Represents a source of both the data address and the data length fields. A block-descriptor can be either a single value or a double value. The following is the single-value form:

OPTION(blkname)

#### **blkname**

The name of a block-descriptor. A pair of contiguous fullwords, in which the first word contains the address of the data, and the second word contains the length in bytes of the data, as a fullword binary value. Register notation is not accepted for this single-value form.

The following is the double-value form:

OPTION(addr,len)

**addr** The data address as {namea | (Ra) | aliteral}:

#### **namea**

The name of a location containing the data address

#### **(Ra)**

A register containing the data address

#### **aliteral**

An address constant literal; for example: A(data).

**len** The data length as {name1 | (Rn) | expression}:

**name1** The name of a location containing a binary fullword giving the data length in bytes

**(Rn)** A register, the contents of which specify in fullword binary the number of bytes of data

**expression**  
A decimal integer, or any arithmetic expression, including symbolic values, valid in assembler language; for example:  
L'AREA ; L'AREA+10 ; L'AREA+X'22' ; SYMB/3+20 .

### buffer-descriptor

Represents a source of both the data address and the maximum data length fields. Parts of the buffer-descriptor are also reserved to act as receiving fields for output information. A buffer-descriptor can be either a single value or a multiple value. The following is the single-value form:

OPTION(bufdname)

### bufdname

The name of a buffer-descriptor. A group of up to four contiguous fullwords, that represent multiple components of the buffer-descriptor. The fields are interpreted as follows:

- The first word contains the address of the data (input).
- The second word is reserved to receive the current length in bytes of the data, as a fullword binary value (output). If three components are specified, the third component maps to this word. If only two components are specified in the buffer-descriptor, the second component maps to this word.
- The third word contains the maximum length in bytes of the data, as a fullword binary value (input). If three components are specified, the second component maps to this word. If only two components are specified in the buffer-descriptor, this field is not used.
- The fourth word is reserved for use by the XPI.

Register notation is not accepted for this single-value form.

The following is the multiple-value form:

OPTION(addr,maxlen,\*)

**addr** The data address as {namea | (Ra) | aliteral}:

#### namea

The name of a location containing the data address

#### (Ra)

A register containing the data address

#### aliteral

An address constant literal, for example, A(data).

### maxlen

The maximum data length as {name1 | (Rn) | expression}:

#### name1

The name of a location containing a binary fullword giving the maximum data length in bytes

**(Rn)** A register, the contents of which specify in fullword binary the maximum number of bytes of data

**expression**

A decimal integer, or any arithmetic expression, including symbolic values, valid in assembler language; for example:

L'AREA ; L'AREA+10 ; L'AREA+X'22' ; SYMB/3+20 .

- \* A required parameter to indicate that the parameter list is to be used for the reserved fields. If this parameter is coded, then the required value must be taken from the \_N component returned in the buffer-descriptor.

---

## Directory domain XPI functions

There are ten XPI directory domain functions.

1. BIND\_LDAP
2. END\_BROWSE\_RESULTS
3. FLUSH\_LDAP\_CACHE
4. FREE\_SEARCH\_RESULTS
5. GET\_ATTRIBUTE\_VALUE
6. GET\_NEXT\_ATTRIBUTE
7. GET\_NEXT\_ENTRY
8. SEARCH\_LDAP
9. START\_BROWSE\_RESULTS
10. UNBIND\_LDAP

These are the DFHDDAPX calls. The *CICS Internet Guide* provides more information on use of these functions.

## The BIND\_LDAP call

The BIND\_LDAP call establishes a session with an LDAP server. The server is identified by one of the following:

- The LDAP URL and the distinguished name and password of the user authorized to extract the expected data.
- A RACF profile in the LDAPBIND class that contains the LDAP URL and distinguished name and password. This is the preferred option, as you do not need to code LDAP credentials in your application.

### BIND\_LDAP

```
DFHDDAPX [CALL],
          [CLEAR],
          [IN,
          FUNCTION(BIND_LDAP),
          {LDAP_BIND_PROFILE(block-descriptor) |
          LDAP_SERVER_URL((block-descriptor),DISTINGUISHED_NAME((block-descriptor),
          PASSWORD(block-descriptor),}
          [CACHE_SIZE(name4),CACHE_TIME_LIMIT(name4),]
          [OUT,
          LDAP_SESSION_TOKEN(name4),
          [LDAP_RESPONSE(name4),]
          RESPONSE(name1 | *),
          REASON(name1 | *)]
```

This command is threadsafe.

**CACHE\_SIZE(name4)**

a fullword that specifies the number of bytes available for caching LDAP search results. A value of zero indicates an unlimited cache size. If **CACHE\_SIZE** is specified, **CACHE\_TIME\_LIMIT** must also be specified. If neither parameter is specified, results will not be cached.

**CACHE\_TIME\_LIMIT(name4)**

a fullword that specifies the amount of time (in seconds) that LDAP search results are cached. A value of zero indicates an unlimited cache time limit.

**DISTINGUISHED\_NAME(block-descriptor)**

specifies the location of the LDAP distinguished name, of the user permitted to bind to the chosen server. The block-descriptor is two fullwords of data, in which the first word contains the address of the data, and the second word contains the length in bytes of the data. For more information on block-descriptors, see "XPI syntax" on page 319.

**LDAP\_BIND\_PROFILE(block-descriptor)**

specifies the location of the name of a RACF profile in the LDAPBIND class that contains the URL and credentials for the LDAP server being accessed. The block-descriptor is two fullwords of data, in which the first word contains the address of the data, and the second word contains the length in bytes of the data. For more information on block-descriptors, see "XPI syntax" on page 319. You should specify either **LDAP\_BIND\_PROFILE**, or all three **LDAP\_SERVER\_URL**, **DISTINGUISHED\_NAME** and **PASSWORD** parameters.

**LDAP\_RESPONSE(name4)**

specifies the return code that is sent by the LDAP API, in response to receiving URL and user credentials.

**LDAP\_SERVER\_URL(block-descriptor)**

specifies the location of the LDAP URL (in the format ldap://server:port) of the LDAP server being accessed. If the colon and port number are omitted, the port defaults to 389. The block-descriptor is two fullwords of data, in which the first word contains the address of the data, and the second word contains the length in bytes of the data. For more information on block-descriptors, see "XPI syntax" on page 319.

**LDAP\_SESSION\_TOKEN(name4)**

the name of the fullword token that specifies the LDAP connection.

**PASSWORD(block-descriptor)**

specifies the location of the password for the user identified in the **DISTINGUISHED\_NAME** input. The block-descriptor is two fullwords of data, in which the first word contains the address of the data, and the second word contains the length in bytes of the data. For more information on block-descriptors, see "XPI syntax" on page 319.

**RESPONSE and REASON values for BIND\_LDAP:**

<i>RESPONSE</i>	<i>REASON</i>
OK	None
EXCEPTION	INVALID_BUFFER_LENGTH
	INVALID_LDAP_PROFILE
	INVALID_LDAP_URL
	LDAP_INACTIVE
	NOTAUTH
	NOTFOUND
DISASTER	None
INVALID	None



<i>RESPONSE</i>	<i>REASON</i>
KERNERROR	None
PURGED	None

**Note:** For more detail, refer to the explanation of RESPONSE and REASON in “Making an XPI call” on page 308.

## The END\_BROWSE\_RESULTS call

The END\_BROWSE\_RESULTS call allows you to end the browse session that was started by the START\_BROWSE\_RESULTS call.

### END\_BROWSE\_RESULTS

```
DFHDDAPX [CALL],
  [CLEAR],
  [IN,
  FUNCTION(END_BROWSE_RESULTS),
  SEARCH_TOKEN(name4),]
  [OUT,
  [LDAP_RESPONSE(name4),]
  RESPONSE(name1 | *),
  REASON(name1 | *)]
```

This command is threadsafe.

#### LDAP\_RESPONSE(name4)

specifies the return code that is sent by the LDAP API.

#### SEARCH\_TOKEN(name4)

the name of the fullword token that is returned by the SEARCH\_LDAP function.

### RESPONSE and REASON values for END\_BROWSE\_RESULTS:

<i>RESPONSE</i>	<i>REASON</i>
OK	None
EXCEPTION	INVALID_TOKEN
	INVALID_CALLING_SEQUENCE
	NOTFOUND
DISASTER	None
INVALID	None
KERNERROR	None
PURGED	None

**Note:** For more detail, refer to the explanation of RESPONSE and REASON in “Making an XPI call” on page 308.

## The FLUSH\_LDAP\_CACHE call

The FLUSH\_LDAP\_CACHE call removes the contents of all cached search responses for the specified LDAP connection.

### FLUSH\_LDAP\_CACHE

```
DFHDDAPX [CALL],
  [CLEAR],
  [IN,
  FUNCTION(FLUSH_LDAP_CACHE),
  LDAP_SESSION_TOKEN(name4),]
```

```
[OUT,
 [LDAP_RESPONSE(name4),]
 RESPONSE(name1 | *),
 REASON(name1 | *)]
```

This command is threadsafe.

**LDAP\_RESPONSE(name4)**

specifies the return code that is sent by the LDAP API.

**LDAP\_SESSION\_TOKEN(name4)**

the name of the fullword token that was returned by the BIND\_LDAP function.

**RESPONSE and REASON values for FLUSH\_LDAP\_CACHE:**

<i>RESPONSE</i>	<i>REASON</i>
OK	None
EXCEPTION	INVALID_TOKEN
	LDAP_INACTIVE
DISASTER	None
INVALID	None
KERNERROR	None
PURGED	None

**Note:** For more detail, refer to the explanation of RESPONSE and REASON in “Making an XPI call” on page 308.

## The FREE\_SEARCH\_RESULTS call

The FREE\_SEARCH\_RESULTS call releases all storage held by the SEARCH\_LDAP function. The search results are terminated and the search token is invalidated. If the application does not call the FREE\_SEARCH\_RESULTS function, it is invoked by CICS when the task is terminated.

**FREE\_SEARCH\_RESULTS**

```
DFHDDAPX [CALL],
 [CLEAR],
 [IN,
 FUNCTION(FREE_SEARCH_RESULTS),
 SEARCH_TOKEN(name4),]
 [OUT,
 [LDAP_RESPONSE(name4),]
 RESPONSE(name1 | *),
 REASON(name1 | *)]
```

This command is threadsafe.

**LDAP\_RESPONSE(name4)**

specifies the return code that is sent by the LDAP API.

**SEARCH\_TOKEN(name4)**

the name of the fullword token that is returned by the SEARCH\_LDAP function.

**RESPONSE and REASON values for FREE\_SEARCH\_RESULTS:**

<i>RESPONSE</i>	<i>REASON</i>
OK	None
EXCEPTION	INVALID_TOKEN
DISASTER	None

<i>RESPONSE</i>	<i>REASON</i>
INVALID	None
KERNERROR	None
PURGED	None

**Note:** For more detail, refer to the explanation of *RESPONSE* and *REASON* in “Making an XPI call” on page 308.

## The `GET_ATTRIBUTE_VALUE` call

The `GET_ATTRIBUTE_VALUE` call allows you to retrieve the value associated with an attribute returned by the `SEARCH_LDAP` call. An entry is an LDAP record, and an attribute is one element within an entry. The attribute can be returned by either the `GET_NEXT_ATTRIBUTE` function, or by specifying the name of the attribute.

### `GET_ATTRIBUTE_VALUE`

```
DFHDDAPX [CALL],
  [CLEAR],
  [IN,
  FUNCTION(GET_ATTRIBUTE_VALUE),
  SEARCH_TOKEN(name4),
  LDAP_ATTRIBUTE_NAME(block-descriptor),
  LDAP_ATTRIBUTE_VALUE(buffer-descriptor),
  [ATTRIBUTE_TYPE(name4),]
  [VALUE_ARRAY_POSITION(name4),]]
  [OUT,
  [LDAP_RESPONSE(name4),]
  RESPONSE(name1 | *),
  REASON(name1 | *)]
```

This command is threadsafe.

#### **ATTRIBUTE\_TYPE(name4)**

specifies the keyword `CHARACTER` or `BINARY`, indicating the format of the attribute. If this parameter is not specified, a value of `CHARACTER` is assumed.

#### **LDAP\_ATTRIBUTE\_NAME(block-descriptor)**

specifies the location of the LDAP attribute name. The block-descriptor is two fullwords of data, in which the first word contains the address of the attribute name, and the second word contains the length in bytes of the attribute name. For more information on block-descriptors, see “XPI syntax” on page 319.

#### **LDAP\_ATTRIBUTE\_VALUE(buffer-descriptor)**

indicates the buffer where you want the attribute value returned. A group of three fullwords are specified for the buffer-descriptor:

- The address where the result is returned.
- The maximum size in bytes, of the data returned.
- The actual length in bytes of the result. This can be specified as `*`, and the length is then returned in `DDAP_LDAP_ATTRIBUTE_VALUE_N`.

For more information on buffer-descriptors, see “XPI syntax” on page 319.

#### **LDAP\_RESPONSE(name4)**

specifies the return code that is sent by the LDAP API.

#### **SEARCH\_TOKEN(name4)**

the name of the fullword token that is returned by the `SEARCH_LDAP` function.

**VALUE\_ARRAY\_POSITION(name4)**

specifies the position of the requested value, in the value array for the current attribute. This parameter is only required if multiple values are expected. Array indexing starts at position 1.

**RESPONSE and REASON values for GET\_ATTRIBUTE\_VALUE:**

<i>RESPONSE</i>	<i>REASON</i>
OK	None
EXCEPTION	INVALID_TOKEN
	NOTFOUND
	INVALID_BUFFER_LENGTH
	INVALID_CALLING_SEQUENCE
DISASTER	None
INVALID	None
KERNERROR	None
PURGED	None

**Note:** For more detail, refer to the explanation of RESPONSE and REASON in “Making an XPI call” on page 308.

**The GET\_NEXT\_ATTRIBUTE call**

The GET\_NEXT\_ATTRIBUTE call allows you to get the next attribute in a series, from an entry returned by the SEARCH\_LDAP call. An entry is an LDAP record, and an attribute is one element within an entry.

**GET\_NEXT\_ATTRIBUTE**

```
DFHDDAPX [CALL],
  [CLEAR],
  [IN,
  FUNCTION(GET_NEXT_ATTRIBUTE),
  SEARCH_TOKEN(name4),
  LDAP_ATTRIBUTE_NAME(buffer-descriptor),]
  [OUT,
  [LDAP_RESPONSE(name4),]
  [VALUE_COUNT(name4),]
  RESPONSE(name1 | *),
  REASON(name1 | *)]
```

This command is threadsafe.

**LDAP\_ATTRIBUTE\_NAME(buffer-descriptor)**

indicates the buffer where you want the attribute name returned. A group of three fullwords are specified for the buffer-descriptor:

- The address where the data is returned.
- The maximum size in bytes, of the data returned.
- The actual length in bytes of the data. This can be specified as \*, and the length is then returned in DDAP\_LDAP\_ATTRIBUTE\_NAME\_N.

For more information on buffer-descriptors, see “XPI syntax” on page 319.

**LDAP\_RESPONSE(name4)**

specifies the return code that is sent by the LDAP API.

**SEARCH\_TOKEN(name4)**

the name of the fullword token that is returned by the SEARCH\_LDAP function.

**VALUE\_COUNT(name4)**

a fullword containing the number of values returned for this attribute. There is usually one value returned.

**RESPONSE and REASON values for GET\_NEXT\_ATTRIBUTE:**

<i>RESPONSE</i>	<i>REASON</i>
OK	None
EXCEPTION	BROWSE_END
	INVALID_BUFFER_LENGTH
	INVALID_CALLING_SEQUENCE
	INVALID_TOKEN
	NOT_FOUND
DISASTER	None
INVALID	None
KERNERROR	None
PURGED	None

**Note:** For more detail, refer to the explanation of RESPONSE and REASON in “Making an XPI call” on page 308.

**The GET\_NEXT\_ENTRY call**

The GET\_NEXT\_ENTRY call allows you to get the next entry, from a series of entries returned by the SEARCH\_LDAP call. An entry is an LDAP record. The distinguished name associated with the entry is returned by this call.

**GET\_NEXT\_ENTRY**

```
DFHDDAPX [CALL],
  [CLEAR],
  [IN,
  FUNCTION(GET_NEXT_ENTRY),
  SEARCH_TOKEN(name4),
  [DISTINGUISHED_NAME(buffer-descriptor),]]
  [OUT,
  [LDAP_RESPONSE(name4),]
  [ATTRIBUTE_COUNT(name4),]
  RESPONSE(name1 | *),
  REASON(name1 | *)]
```

This command is threadsafe.

**ATTRIBUTE\_COUNT(name4)**

specifies the number of attributes in the retrieved entry.

**DISTINGUISHED\_NAME(buffer-descriptor)**

indicates the buffer where you want the distinguished name of the next entry in the search returned. A group of three fullwords are specified for the buffer-descriptor:

- The address where the data is returned.
- The maximum size in bytes, of the data is returned.
- The actual length in bytes of the data. This can be specified as \*, and the length is then returned in DDAP\_DISTINGUISHED\_NAME\_N.

For more information on buffer-descriptors, see “XPI syntax” on page 319.

**LDAP\_RESPONSE(name4)**

specifies the return code that is sent by the LDAP API.

#### SEARCH\_TOKEN(name4)

the name of the fullword token that is returned by the SEARCH\_LDAP function.

#### RESPONSE and REASON values for GET\_NEXT\_ENTRY:

<i>RESPONSE</i>	<i>REASON</i>
OK	None
EXCEPTION	INVALID_TOKEN INVALID_BUFFER_LENGTH INVALID_CALLING_SEQUENCE BROWSE_END
DISASTER	None
INVALID	None
KERNERROR	None
PURGED	None

**Note:** For more detail, refer to the explanation of RESPONSE and REASON in “Making an XPI call” on page 308.

## The SEARCH\_LDAP call

The SEARCH\_LDAP call sends a search request to a specified LDAP server. The search specifies an LDAP distinguished name, that is the target of the search. The search returns a series of results (attributes or entries) that can be browsed or selected. An entry is an LDAP record, and an attribute is one element within an entry.

#### SEARCH\_LDAP

```
DFHDDAPX [CALL],  
  [CLEAR],  
  [IN,  
  FUNCTION(SEARCH_LDAP),  
  LDAP_SESSION_TOKEN(name4),  
  DISTINGUISHED_NAME(block-descriptor),  
  [FILTER(block-descriptor),]  
  [SEARCH_TIME_LIMIT(name4),]]  
  [OUT,  
  SEARCH_TOKEN(name4),  
  [LDAP_RESPONSE(name4),]  
  [ENTRY_COUNT(name4),]  
  RESPONSE(name1 | *),  
  REASON(name1 | *)]
```

This command is threadsafe.

#### DISTINGUISHED\_NAME(block-descriptor)

specifies the location of the LDAP distinguished name. The block-descriptor is two fullwords of data, in which the first word contains the address of the data, and the second word contains the length in bytes of the data. For more information on block-descriptors, see “XPI syntax” on page 319.

#### ENTRY\_COUNT(name4)

the number of LDAP entries returned by the search.

#### FILTER(block-descriptor)

specifies the location of an LDAP filter string that limits the search. If this parameter is not specified or is zero, the search filter is set to (objectClass=\*). The block-descriptor is two fullwords of data, in which the first word contains the

address of the data, and the second word contains the length in bytes of the data. For more information on block-descriptors, see “XPI syntax” on page 319.

**LDAP\_RESPONSE(name4)**

specifies the return code that is sent by the LDAP API.

**LDAP\_SESSION\_TOKEN(name4)**

the name of the fullword token that was returned by the BIND\_LDAP function.

**SEARCH\_TIME\_LIMIT(name4)**

specifies the time limit for the search (in seconds). If the search is not successful within this time limit, the search is abandoned. If this parameter is not specified or is zero, the search time is unlimited.

**SEARCH\_TOKEN(name4)**

the name of the fullword token that identifies and holds the current position in the search.

**RESPONSE and REASON values for SEARCH\_LDAP:**

<i>RESPONSE</i>	<i>REASON</i>
OK	None
EXCEPTION	INVALID_BUFFER_LENGTH INVALID_TOKEN NOTFOUND TIMED_OUT LDAP_INACTIVE
DISASTER	None
INVALID	None
KERNERROR	None
PURGED	None

**Note:** For more detail, refer to the explanation of RESPONSE and REASON in “Making an XPI call” on page 308.

## The START\_BROWSE\_RESULTS call

The START\_BROWSE\_RESULTS call allows you to browse the results (attributes or entries) returned by the SEARCH\_LDAP call. START\_BROWSE\_RESULTS starts the browse at the first or only entry returned (there may be multiple entries returned by the search). The GET\_NEXT\_ENTRY call allows you to retrieve other entries.

START\_BROWSE\_RESULTS can be issued more than once for a SEARCH\_TOKEN. If the call is issued after a GET\_NEXT\_ENTRY or GET\_NEXT\_ATTRIBUTE call, the browse position will be reset to the start of the search results.

### START\_BROWSE\_RESULTS

```
DFHDDAPX [CALL],  
  [CLEAR],  
  [IN,  
  FUNCTION(START_BROWSE_RESULTS),  
  SEARCH_TOKEN(name4),  
  [DISTINGUISHED_NAME(buffer-descriptor),]]  
  [OUT,
```

```
[LDAP_RESPONSE(name4),]
[ATTRIBUTE_COUNT(name4),]
RESPONSE(name1 | *),
REASON(name1 | *)]
```

This command is threadsafe.

**DISTINGUISHED\_NAME(buffer-descriptor)**

indicates the buffer where you want the distinguished name of the first, or only located result returned. A group of three fullwords are specified for the buffer-descriptor:

- The address where the data is returned.
- The length of the buffer in bytes, where the data is returned.
- The maximum length in bytes of the data. This can be specified as \*, and the length is then returned in DDAP\_DISTINGUISHED\_NAME\_N.

For more information on buffer-descriptors, see “XPI syntax” on page 319.

**ATTRIBUTE\_COUNT(name4)**

a fullword indicating the number of attributes that can be browsed in the current entry.

**LDAP\_RESPONSE(name4)**

specifies the return code that is sent by the LDAP API.

**SEARCH\_TOKEN(name4)**

the name of the fullword token that is returned by the SEARCH\_LDAP function.

**RESPONSE and REASON values for START\_BROWSE\_RESULTS:**

<i>RESPONSE</i>	<i>REASON</i>
OK	None
EXCEPTION	INVALID_TOKEN
	INVALID_BUFFER_LENGTH
	INVALID_CALLING_SEQUENCE
DISASTER	None
INVALID	None
KERNERROR	None
PURGED	None

**Note:** For more detail, refer to the explanation of RESPONSE and REASON in “Making an XPI call” on page 308.

## The UNBIND\_LDAP call

The UNBIND\_LDAP call terminates a session with an LDAP server.

**UNBIND\_LDAP**

```
DFHDDAPX [CALL],
  [CLEAR],
  [IN,
  FUNCTION(UNBIND_LDAP),
  LDAP_SESSION_TOKEN(name4),]
  [OUT,
  [LDAP_RESPONSE(name4),]
  RESPONSE(name1 | *),
  REASON(name1 | *)]
```



This command is threadsafe.

**LDAP\_RESPONSE(name4)**

specifies the return code that is sent by the LDAP API.

**LDAP\_SESSION\_TOKEN(name4)**

the name of the fullword token that was returned by the BIND\_LDAP function.

**RESPONSE and REASON values for UNBIND\_LDAP:**

<i>RESPONSE</i>	<i>REASON</i>
OK	None
EXCEPTION	INVALID_TOKEN LDAP_INACTIVE
DISASTER	None
INVALID	None
KERNERROR	None
PURGED	None

**Note:** For more detail, refer to the explanation of RESPONSE and REASON in “Making an XPI call” on page 308.

---

## Dispatcher XPI functions

There are six XPI dispatcher functions. These are the DFHDSSRX calls ADD\_SUSPEND, SUSPEND, RESUME, DELETE\_SUSPEND, and WAIT\_MVS, and the DFHDSATX call CHANGE\_PRIORITY.

Usage of these dispatcher calls is very limited. Check the details supplied for each exit in Chapter 1, “Global user exit programs,” on page 3 before using any functions.

**Note:**

1. You must issue an ADD\_SUSPEND call to create a suspend token **before** you issue a SUSPEND or RESUME call.
2. If a suspended task is canceled, the SUSPEND fails with a RESPONSE value of ‘PURGED’ and a REASON value of ‘TASK\_CANCELLED’. A corresponding RESUME call returns with a RESPONSE value of ‘EXCEPTION’ and a REASON value of ‘TASK\_CANCELLED’.
3. If a suspended task is timed out, the SUSPEND fails with a RESPONSE value of ‘PURGED’ and a REASON value of ‘TIMED\_OUT’. A corresponding RESUME call returns with a RESPONSE value of ‘EXCEPTION’ and a REASON value of ‘TIMED\_OUT’.
4. Dispatcher protocols require that you issue a RESUME even if the SUSPEND was purged (due to task cancel or time-out). You must issue one and only one RESUME for each SUSPEND call.

## Synchronization protocols for SUSPEND and RESUME processing

This section describes the protocols that must be observed by users of XPI SUSPEND and RESUME processing, so that task purging can be handled effectively.

## The normal synchronization protocol

In the normal case, synchronization involves two tasks and three operations. In the following sample operations, the tasks are A (the task that requests a service) and B (the task that processes a request from task A).

1. Task A starts the request by:
  - Setting the parameters to be used by task B
  - Resuming task B
  - Issuing the SUSPEND call.
2. Task B performs the action by:
  - Getting the parameters
  - Performing the action
  - Setting the results
  - Terminating (or waiting for new work).
3. Task A ends the interaction by:
  - Getting the results left by task B.

This sequence looks like:

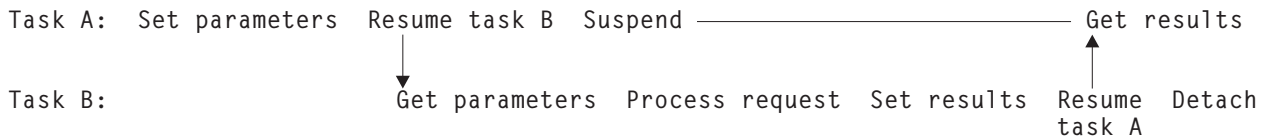

Ignoring the Resume and Suspend, the execution amounts to:

Set parameters; Get parameters; Process request; Set results; Get results

where these actions are always **sequential**.

## The synchronization protocol and task purge

If one of the tasks is to be purged, it is task A, because task A is the one suspended. In this case, execution of task A after the failed SUSPEND would be in parallel with task B; the proper serialization would be lost. If the program were left unchanged, Process request and Set results would be taking place at the same time as Get results, with unpredictable results.

One way of preventing this problem is to ensure that **task A, if it is to be purged, does not do anything that could interfere with task B**. (This may well mean that A must not detach, if doing so releases storage that B needs to access.) Because the only task that is now involved is task B, B is left with the responsibility of cleaning up for both tasks.

The sequence is:

Task A: Set parameters; Resume task B; Suspend-fail



Task B: Get parameters; Process request; Resume-fail; Clean up both

Because task-purging is effective only if performed between SUSPEND and RESUME, Suspend-fail precedes Resume-fail. This means that, with the same constraints on serialization as in the normal synchronization protocol, the task-purge protocol can be logically reduced to:

Set parameters; Get parameters; Process request; Clean up

The difference is that Set results and Get results are replaced by Clean up. It is vital that only these two sequences can happen; this means that both programs must be coded correctly. CICS ensures that both tasks are told either that SUSPEND and RESUME processing worked, or that it failed.

The following shows the programming steps that conform to these rules:

Program for Task A	Program for Task B
SET PARAMETERS;	GET PARAMETERS;
RESUME B;	PROCESS REQUEST;
SUSPEND A;	RESUME A;
if	if
RESPONSE = OK	RESPONSE $\neq$ OK
then	then
GET RESULTS;	CLEAN UP;
endif	endif

If both the SUSPEND and RESUME return 'OK', the example follows the rules for the normal synchronization; processing finishes at Get results. If neither SUSPEND nor RESUME returns 'OK', the example follows the rules for the task-purge protocol, and processing finishes at Clean up.

For further information about SUSPEND and RESUME processing, see the *CICS Problem Determination Guide*.

### Alternative approach to task purge

The sequence described above is one method for dealing with the problem of task purge. Using this method, task B does not know, when it is processing the request, whether or not task A has been purged; this means that B must take great care in its use of resources owned by A (in case A has been purged). In some situations, this restriction may cause difficulties.

A different approach is as follows; if task A is to be purged:

1. A communicates to B that it is no longer available, thus informing B not to use any resources owned by A.
2. A performs its own clean-up processing (including issuing the RESUME call for the purged SUSPEND, as required by the dispatcher protocols), and abends.
3. B performs its own clean-up processing.

## The ADD\_SUSPEND call

ADD\_SUSPEND acquires a suspend token that can later be used to identify a SUSPEND/RESUME pair.

### ADD\_SUSPEND

```
DFHSSRX [CALL,]  
        [CLEAR,]  
        [IN,  
        FUNCTION(ADD_SUSPEND),  
        [RESOURCE_NAME(name16 | string | 'string'),]  
        [RESOURCE_TYPE(name8 | string | 'string'),]]  
        [OUT,  
        SUSPEND_TOKEN(name4 | (Rn)),  
        RESPONSE(name1 | *),  
        REASON(name1 | *)]
```

This command is threadsafe.

#### RESOURCE\_NAME(name16 | string | "string")

specifies a 16-character string that can be used to document and trace the resource involved in suspend and resume processing. You cannot use register notation to specify the address of the string.

##### name16

The name of the location where a 16-byte value is stored.

**string** A string of characters without intervening blanks; if it is not 16 bytes long, it is extended with blanks or truncated as required.

##### "string"

A string of characters enclosed in quotation marks. Blanks are permitted in the enclosed string. If you want to document a name (label) in your program, use this form.

**Note:** RESOURCE\_NAME on ADD\_SUSPEND supplies a default value which is used if RESOURCE\_NAME is not specified on a SUSPEND call.

#### RESOURCE\_TYPE(name8 | string | "string")

specifies an 8-character string that can be used to document and trace the resource involved in suspend and resume processing. You cannot use register notation to specify the address of the string.

##### name8

The name of the location where an 8-byte value is stored.

**string** A string of characters without intervening blanks; if it is not 8 bytes long, it is extended with blanks or truncated as required.

##### "string"

A string of characters enclosed in quotation marks. Blanks are permitted in the enclosed string. If you want to document a name (label) in your program, use this form.

**Note:** RESOURCE\_TYPE on ADD\_SUSPEND supplies a default value which is used if RESOURCE\_TYPE is not specified on a SUSPEND call.

#### SUSPEND\_TOKEN(name4 | (Rn))

returns a token assigned by the system to identify the SUSPEND/RESUME pair of operations used on the task.

**name4**

The name of a 4-byte field where the token is stored

**(Rn)**

A register into which the token value is loaded.

**RESPONSE and REASON values for ADD\_SUSPEND:**

<i>RESPONSE</i>	<i>REASON</i>
OK	None
EXCEPTION	None
DISASTER	None
INVALID	None
KERNERROR	None
PURGED	None

**Note:** For more detail, refer to the explanation of RESPONSE and REASON in “Making an XPI call” on page 308.

**The SUSPEND call**

SUSPEND suspends execution of a running task. The task can be resumed in one of two ways. You can issue the XPI RESUME call, or the task is resumed automatically if the INTERVAL value that you specify on the DFHDSSRX macro expires. Suspended tasks can also be purged by the operator, or by an application, or by the deadlock time-out facility.

**SUSPEND**

```
DFHDSSRX [CALL,]
  [CLEAR,]
  [IN,]
  FUNCTION(SUSPEND),
  PURGEABLE(YES|NO),
  SUSPEND_TOKEN(name4 | (Rn)),
  [INTERVAL(name4 | (Rn)),]
  [RESOURCE_NAME(name16 | string | 'string'),]
  [RESOURCE_TYPE(name8 | string | 'string'),]
  [TIME_UNIT(SECOND|MILLI_SECOND),]
  [WLM_WAIT_TYPE,]
  [OUT,]
  [COMPLETION_CODE(name1 | (Rn)),]
  RESPONSE(name1 | *),
  REASON(name1 | *)]
```

This command is threadsafe.

**COMPLETION\_CODE (name1 | (Rn))**

returns a user-defined “reason for action” code during suspend and resume processing.

**name1**

The name of a 1-byte area to receive the code. The value in this field is user-defined, and is ignored by CICS.

**(Rn)**

A register in which the low-order byte contains the completion code and the other bytes are zero.

**INTERVAL(name4 | (Rn))**

specifies in seconds or milliseconds the time after which the task is automatically resumed and given a RESPONSE value of ‘PURGED’ and a REASON value of ‘TIMED\_OUT’. The time unit used on the INTERVAL option

depends on the setting of the TIME\_UNIT option. The INTERVAL value overrides any time-out (DTIMOUT) value specified for the transaction.

**name4**

The name of a 4-byte area, which is interpreted as a binary fullword.

**(Rn)** A register containing the interval value, a binary fullword.

**PURGEABLE(YES|NO)**

specifies whether your code can cope with the request being abnormally terminated as a result of a purge. There are four types of purge, as shown in Table 17. Specifying PURGEABLE(NO) tells the dispatcher:

- To reject any attempt to PURGE the task.
- To suppress the deadlock time-out (DTIMOUT) facility (if applicable to this task) for the duration of this request.

Table 17. SUSPEND call - RESPONSE(PURGED)

REASON	TASK_CANCELLED		TIMED_OUT	
CONDITION	PURGE	FORCEPURGE	DTIMOUT	INTERVAL
<b>PURGEABLE (NO)</b>	Canceled	Proceeds normally	Canceled	Proceeds normally
<b>PURGEABLE (YES)</b>	Proceeds normally	Proceeds normally	Proceeds normally	Proceeds normally

**Note:** A FORCEPURGE always assumes that the user wants the task to be purged, and so overrides the PURGEABLE(NO) option. If the user has set an INTERVAL, then this, too, overrides the PURGEABLE(NO) option.

**RESOURCE\_NAME(name16 | string | "string")**

specifies a 16-character string that can be used to document and trace the resource involved in suspend and resume processing. You cannot use register notation to specify the address of the string.

**name16**

The name of the location where a 16-byte value is stored.

**string** A string of characters without intervening blanks; if it is not 16 bytes long, it is extended with blanks or truncated as required.

**"string"**

A string of characters enclosed in quotation marks. Blanks are permitted in the enclosed string. If you want to document a name (label) in your program, use this form.

**Note:**

1. CICS does not use the RESOURCE\_NAME information but includes it in trace entries, and displays it on appropriate CEMT screens to help you to see what your task is doing. CICS internal requests specify values, and you should use different values to avoid ambiguity. CICS internal request values are documented in the *CICS Problem Determination Guide*.
2. If RESOURCE\_NAME is not specified, the default value, if any, from ADD\_SUSPEND is used.

**RESOURCE\_TYPE(name8 | string | "string")**

specifies an 8-character string that can be used to document and trace the resource involved in suspend and resume processing. You cannot use register notation to specify the address of the string.

**name8**

The name of the location where an 8-byte value is stored.

**string** A string of characters without intervening blanks; if it is not 8 bytes long, it is extended with blanks or truncated as required.

**"string"**

A string of characters enclosed in quotation marks. Blanks are permitted in the enclosed string. If you want to document a name (label) in your program, use this form.

**Note:**

1. CICS does not use the RESOURCE\_TYPE information but includes it in trace entries, and displays it on appropriate CEMT screens to help you to see what your task is doing. CICS internal requests specify values, and you should use different values to avoid ambiguity. CICS internal request values are documented in The resources on which tasks in a CICS system can wait, in the *CICS Problem Determination Guide*.
2. If RESOURCE\_TYPE is not specified, the default value, if any, from ADD\_SUSPEND is used.

**SUSPEND\_TOKEN(name4 | (Rn))**

specifies a token assigned by the system to identify the SUSPEND/RESUME pair of operations used on the task.

**name4**

The name of a location where you have a 4-byte token previously obtained as output from an ADD\_SUSPEND call

**(Rn)** A register containing the token value.

**TIME\_UNIT(SECOND | MILLI\_SECOND)**

specifies the time unit used on the INTERVAL option.

**SECOND**

The INTERVAL option specifies the number of seconds before timeout.

**MILLI\_SECOND**

The INTERVAL option specifies the number of milliseconds before timeout.

**WLM\_WAIT\_TYPE(name1)**

specifies, in a 1-byte location, the reason for suspending the task. This indicates the nature of the task's wait state to the MVS workload manager.

The equated values for the type of wait are as follows:

**CMDRESP**

Waiting on a command response.

**CONV**

Waiting on a conversation.

**DISTRIB**

Waiting on a distributed request.

**IDLE**

A CICS task, acting as a work manager, that has no work request that is allowed to service within the monitoring environment. For example, journaling code that suspends itself when there are no journaling I/O operations to perform.

**IO** Waiting on an I/O operation or indeterminate I/O-related operation (locks, buffer, string, and so on).

**LOCK**

Waiting on a lock.

**MISC**

Waiting on an unidentified resource.

**Note:** This is the default reason given to the wait if you suspend a task and do not specify the WLM\_WAIT\_TYPE parameter.

**OTHER\_PRODUCT**

Waiting on another product to complete its function; for example, when the workload has been passed to DB2.

**SESS\_LOCALMVS**

Waiting on the establishment of a session in the MVS image on which this CICS region is running.

**SESS\_NETWORK**

Waiting on the establishment of a session elsewhere in the network (that is, not on this MVS image).

**SESS\_SYSPLEX**

Waiting on establishment of a session somewhere in the sysplex (that is, not on this MVS image).

**TIMER**

Waiting on the timeout of a timer (for example, a task that puts itself to sleep).

If you are running CICS in an MVS goal-mode workload management environment (that is, you are using goal-oriented performance management), you are recommended to specify the reason for suspending the task on the WLM\_WAIT\_TYPE parameter.

**RESPONSE and REASON values for SUSPEND:**

<i>RESPONSE</i>	<i>REASON</i>
OK	None
EXCEPTION	None
DISASTER	None
INVALID	None
KERNERROR	None
PURGED	TASK_CANCELLED
	TIMED_OUT

**Note:**

1. For more detail, refer to the explanation of RESPONSE and REASON in "Making an XPI call" on page 308.
2. 'TASK\_CANCELLED' means that the task has been canceled by operator action or by an application command.
3. After a 'PURGED' response, the suspend token must not be reused in another SUSPEND until it has been reset by a RESUME corresponding to the purged SUSPEND.
4. 'TIMED\_OUT' means that the task has been automatically resumed because the specified INTERVAL (or the time-out value specified at task



attach) has expired. The token, however, remains suspended and must be the object of a RESUME before it can be the object of a DELETE\_SUSPEND.

## The RESUME call

RESUME restarts execution of a task that is suspended or timed out. There must be only one RESUME request for each SUSPEND. However, because this is an asynchronous interface, a SUSPEND can be received either before or after its corresponding RESUME. You must ensure that you keep account of the SUSPEND and RESUME requests issued from your exit program.

### RESUME

```
DFHSSRX [CALL,]
        [CLEAR,]
        [IN,
        FUNCTION(RESUME),
        SUSPEND_TOKEN(name4 | (Rn)),
        [COMPLETION_CODE(name1 | (Rn)),]
        [OUT,
        RESPONSE(name1 | *),
        REASON(name1 | *)]
```

This command is threadsafe.

#### COMPLETION\_CODE(name1 | (Rn))

specifies a user-defined “reason for RESUME” code during suspend and resume processing.

##### name1

The name of a 1-byte area to receive the code

**(Rn)** A register, in which the low-order byte contains the completion code and the other bytes are zero.

#### SUSPEND\_TOKEN(name4 | (Rn))

specifies a token assigned by the system to identify the SUSPEND/RESUME pair of operations used on the task.

##### name4

The name of a location where you have a 4-byte token previously obtained as output from an ADD\_SUSPEND call

**(Rn)** A register containing the token value.

### RESPONSE and REASON values for RESUME:

<i>RESPONSE</i>	<i>REASON</i>
OK	None
EXCEPTION	TASK_CANCELLED
	TIMED_OUT
DISASTER	None
INVALID	None
KERNERROR	None
PURGED	None

#### Note:

1. For more detail, refer to the explanation of RESPONSE and REASON in “Making an XPI call” on page 308.

2. 'TASK\_CANCELLED' means that the task was canceled by operator action while it was suspended, and that the suspend token is available for use.

## The DELETE\_SUSPEND call

DELETE\_SUSPEND releases a suspend token associated with this task.

### DELETE\_SUSPEND

```
DFHDSSRX [CALL,]
          [CLEAR,]
          [IN,
           FUNCTION(DELETE_SUSPEND),
           SUSPEND_TOKEN(name4 | (Rn)),]
          [OUT,
           RESPONSE(name1 | *),
           REASON(name1 | *)]
```

This command is threadsafe.

#### SUSPEND\_TOKEN(name4 | (Rn) )

specifies a token assigned by the system to identify the SUSPEND/RESUME pair of operations used on the task.

##### name4

The name of a 4-byte field, where the token obtained by an ADD\_SUSPEND call has been stored

**(Rn)** A register containing the token value previously obtained.

### RESPONSE and REASON values for DELETE\_SUSPEND:

<i>RESPONSE</i>	<i>REASON</i>
OK	None
EXCEPTION	None
DISASTER	None
INVALID	None
KERNERROR	None
PURGED	None

**Note:** For more detail, refer to the explanation of RESPONSE and REASON in "Making an XPI call" on page 308.

## The WAIT\_MVS call

WAIT\_MVS requests a wait on an MVS event control block (ECB) or on a list of MVS ECBs. For example, you could issue the WAIT\_MVS to wait for completion of an MVS task for which you have issued ATTACH and provided a task-completion ECB.

The dispatcher does not clear the ECBs when a WAIT\_MVS request is received. If any ECB is already posted, control is returned immediately to the exit program with a response of 'OK'.

A single ECB must not be the subject of more than one wait at a time. If any ECB is already being waited on when a WAIT\_MVS request is received, the request is rejected. The RESPONSE code is 'DSSR\_INVALID', and the REASON code 'DSSR\_ALREADY\_WAITING'.

**Note:** ECBs used in WAIT\_MVS requests must never be “hand posted”. They must be posted using the MVS POST macro.

## WAIT\_MVS

```
DFHDSSRX [CALL,]
  [CLEAR,]
  [IN,
  FUNCTION(WAIT_MVS),
  {ECB_ADDRESS(name4 | (Ra)) | ECB_LIST_ADDRESS(name4 | (Ra)),}
  PURGEABLE(YES|NO),
  [INTERVAL(name4 | (Rn)),]
  [RESOURCE_NAME(name16 | string | 'string'),]
  [RESOURCE_TYPE(name8 | string | 'string'),]
  [TIME_UNIT(SECOND|MILLI_SECOND),]
  [WLM_WAIT_TYPE,]
  [OUT,
  RESPONSE(name1 | *),
  REASON(name1 | *)]
```

This command is threadsafe.

### ECB\_ADDRESS(name4 | (Ra))

specifies the address of the ECB to be waited on.

#### name4

The name of a location that contains an ECB address.

**(Ra)** A register that contains the address of an ECB.

### ECB\_LIST\_ADDRESS(name4 | (Ra))

specifies the address of a list of ECB addresses to be waited on.

#### name4

The name of a location that contains an ECB address, possibly followed by more ECB addresses. The last address word in the list has the high-order bit set to 1.

**(Ra)** A register pointing to an address list as described above.

### INTERVAL(name4 | (Rn))

specifies in seconds or milliseconds the time after which the task is automatically resumed and given a RESPONSE value of 'PURGED' and a REASON value of 'TIMED\_OUT'. The time unit used on the INTERVAL option depends on the setting of the TIME\_UNIT option.

The INTERVAL value overrides any time-out (DTIMOUT) value specified for the transaction.

#### name4

The name of a 4-byte area, which is interpreted as a binary fullword

**(Rn)** A register containing the interval value, a binary fullword.

### PURGEABLE(YES|NO)

specifies whether your code can cope with the request being abnormally terminated as a result of a purge. There are four types of purge, as shown in Table 18. Specifying PURGEABLE(NO) tells the dispatcher:

- To reject any attempt to PURGE the task
- To suppress the deadlock time-out (DTIMOUT) facility (if applicable to this task) for the duration of this request.

Table 18. WAIT\_MVS call - RESPONSE(PURGED)

REASON	TASK_CANCELLED	TIMED_OUT
--------	----------------	-----------

Table 18. WAIT\_MVS call - RESPONSE(PURGED) (continued)

CONDITION	PURGE	FORCEPURGE	DTIMOUT	INTERVAL
PURGEABLE (NO)	Canceled	Proceeds normally	Canceled	Proceeds normally
PURGEABLE (YES)	Proceeds normally	Proceeds normally	Proceeds normally	Proceeds normally

**Note:** A FORCEPURGE always assumes that the user wants the task to be purged, and so overrides the PURGEABLE(NO) option. If the user has set an INTERVAL, then this, too, overrides the PURGEABLE(NO) option.

**RESOURCE\_NAME(name16 | string | "string")**

specifies a 16-character string that can be used to document and trace the resource involved in suspend and resume processing. You cannot use register notation to specify the address of the string.

**name16**

The name of the location where a 16-byte value is stored.

**string** A string of characters without intervening blanks; if it is not 16 bytes long, it is extended with blanks or truncated as required.

**"string"**

A string of characters enclosed in quotation marks. Blanks are permitted in the enclosed string. If you want to document a name (label) in your program, use this form.

**Note:** CICS does not use the RESOURCE\_NAME information but includes it in trace entries, and displays it on appropriate CEMT screens to help you to see what your task is doing. CICS internal requests specify values, and you should use different values to avoid ambiguity. CICS internal request values are documented in The resources on which tasks in a CICS system can wait, in the *CICS Problem Determination Guide*.

**RESOURCE\_TYPE(name8 | string | "string")**

specifies an 8-character string that can be used to document and trace the resource involved in suspend and resume processing. You cannot use register notation to specify the address of the string.

**name** The name of the location where an 8-byte value is stored.

**string** A string of characters without intervening blanks; if it is not 8 bytes long, it will be extended with blanks or truncated as required.

**"string"**

A string of characters enclosed in quotation marks. Blanks are permitted in the enclosed string. If you want to document a name (label) in your program, use this form.

**Note:** CICS does not use the RESOURCE\_TYPE information but includes it in trace entries, and displays it on appropriate CEMT screens to help you to see what your task is doing. CICS internal requests specify values, and you should use different values to avoid ambiguity. CICS internal request values are documented in The resources on which tasks in a CICS system can wait, in the *CICS Problem Determination Guide*.

**TIME\_UNIT(SECOND | MILLI\_SECOND)**

specifies the time unit used on the INTERVAL option.

**SECOND**

The INTERVAL option specifies the number of seconds before timeout.

**MILLI\_SECOND**

The INTERVAL option specifies the number of milliseconds before timeout.

**WLM\_WAIT\_TYPE(name1)**

specifies, in a 1-byte location, the reason for suspending the task. This indicates the nature of the task's wait state to the MVS workload manager.

The equated values for the type of wait are as follows:

**CMDRESP**

Waiting on a command response.

**CONV**

Waiting on a conversation.

**DISTRIB**

Waiting on a distributed request.

**IDLE**

A CICS task, acting as a work manager, that has no work request that is allowed to service within the monitoring environment. For example, journaling code that suspends itself when there are no journaling I/O operations to perform.

**IO** Waiting on an I/O operation or indeterminate I/O-related operation (locks, buffer, string, and so on).

**LOCK**

Waiting on a lock.

**MISC**

Waiting on an unidentified resource.

**Note:** This is the default reason given to the wait if you suspend a task and do not specify the WLM\_WAIT\_TYPE parameter.

**OTHER\_PRODUCT**

Waiting on another product to complete its function; for example, when the workload has been passed to DB2.

**SESS\_LOCALMVS**

Waiting on the establishment of a session in the MVS image on which this CICS region is running.

**SESS\_NETWORK**

Waiting on the establishment of a session elsewhere in the network (that is, not on this MVS image).

**SESS\_SYSPLEX**

Waiting on establishment of a session somewhere in the sysplex (that is, not on this MVS image).

**TIMER**

Waiting on the timeout of a timer (for example, a task that puts itself to sleep).

If you are running CICS in an MVS goal-mode workload management environment (that is, you are using goal-oriented performance management), you are recommended to specify the reason for suspending the task on the WLM\_WAIT\_TYPE parameter.

## RESPONSE and REASON values for WAIT\_MVS:

<i>RESPONSE</i>	<i>REASON</i>
OK	None
EXCEPTION	None
DISASTER	None
INVALID	None
KERNERROR	None
PURGED	TASK_CANCELLED
	TIMED_OUT

### Note:

1. For more detail, refer to the explanation of RESPONSE and REASON in “Making an XPI call” on page 308.
2. ‘TIMED\_OUT’ is returned if the INTERVAL expires, or if a deadlock time-out interval expires.
3. ‘TASK\_CANCELLED’ means that the task has been canceled by operator action or by an application command.

## The CHANGE\_PRIORITY call

CHANGE\_PRIORITY allows the issuing task to change its own priority. It cannot be used to change the priority of another task. This command causes the issuing task to release control, and so provide other tasks with the opportunity to run.

### CHANGE\_PRIORITY

```
DFHDSATX [CALL,]
          [CLEAR,]
          [IN,
          FUNCTION(CHANGE_PRIORITY),
          PRIORITY(name1 | (Rn) | decimalint | literalconst),]
          [OUT,
          [OLD_PRIORITY(name1 | (Rn)),]
          RESPONSE(name1 | *),
          REASON(name1 | *)]
```

This command is threadsafe.

#### OLD\_PRIORITY(name1 | (Rn))

returns the previous priority of the issuing task.

##### name1

The name of a 1-byte field where the task’s previous priority is stored

**(Rn)** A register in which the low-order byte receives the previous priority value and the other bytes are set to zero.

#### PRIORITY(name1 | (Rn) | decimalint | literalconst)

specifies the new priority to be assigned to the issuing task.

##### name1

The name of a 1-byte field, with a value in the range 0 through 255.

**(Rn)** A register with the low-order byte containing the new priority value.

##### decimalint

A decimal integer not exceeding 255 in value. Neither an expression nor hexadecimal notation is allowed.

### literalconst

A number in the form of a literal, for example B'00000000', X'FF', X'FCF4', "0" or an equate symbol with a similar value.

### RESPONSE and REASON values for CHANGE\_PRIORITY:

<i>RESPONSE</i>	<i>REASON</i>
OK	None
DISASTER	None
INVALID	None
KERNERROR	None

**Note:** For more detail, refer to the explanation of RESPONSE and REASON in "Making an XPI call" on page 308.

---

## Dump control XPI functions

There are two XPI dump control functions. These are the DFHDUDUX macro calls SYSTEM\_DUMP and TRANSACTION\_DUMP.

**DFHDUDUX calls cannot be used** in any exit program invoked from any global user exit point in the:

- Statistics domain
- Monitor domain
- Dump domain
- Dispatcher domain
- Transient data program.

## The SYSTEM\_DUMP call

SYSTEM\_DUMP causes a system dump to be taken. If the system dump code that you supply on input is in the system dump code table, the dump may be suppressed. For information about the dump table and how it works, refer to the *CICS Problem Determination Guide* and the *CICS System Programming Reference* manual.

### SYSTEM\_DUMP

```
DFHDUDUX [CALL,]  
    [CLEAR,]  
    [IN,  
    FUNCTION(SYSTEM_DUMP),  
    SYSTEM_DUMPCODE(name8 | string | "string"),  
    CALLER(block-descriptor),]  
    [TITLE(block-descriptor),]  
    [OUT,  
    DUMPID(name9 | *),  
    RESPONSE(name1 | *),  
    REASON(name1 | *)]
```

This command is threadsafe.

#### CALLER(block-descriptor)

specifies the source of a system dump request. The information that you supply

here appears in the dump header, so you could use it to identify the exit program that initiated the system dump request. For a description of valid block-descriptors, see block-descriptor.

**DUMPID(name9 | \*)**

returns the dump identifier.

**name9**

The name of a 9-byte field to receive the assigned ID.

**SYSTEM\_DUMPCODE(name8 | string | "string")**

specifies the code corresponding to the error that caused this system dump call. System dump codes are held in the dump table; for information about the dump table and how it works, refer to the *CICS Problem Determination Guide* and the *CICS System Programming Reference* manual.

**name8**

The name of a location containing an 8-byte string.

**string** A string of characters without intervening blanks. The macro generates, from the string, a literal constant of length 8 bytes, extending with blanks or truncating as required.

**"string"**

A string, enclosed in quotation marks and possibly containing blanks. This value is processed in the same way as the "string" above.

**TITLE(block-descriptor)**

specifies an area containing the text you want to appear in the dump header when the system dump is printed.

### **RESPONSE and REASON values for SYSTEM\_DUMP:**

<i>RESPONSE</i>	<i>REASON</i>
OK	None
EXCEPTION	FESTAE_FAILED
	INSUFFICIENT_STORAGE
	IWMWQWRK_FAILED
	NO_DATASET
	PARTIAL_SYSTEM_DUMP
	SDUMP_BUSY
	SDUMP_FAILED
	SDUMP_NOT_AUTHORIZED
	SUPPRESSED_BY_DUMPOPTION
	SUPPRESSED_BY_DUMPTABLE
	SUPPRESSED_BY_USEREXIT
DISASTER	None
INVALID	INVALID_DUMPCODE
	INVALID_PROBDESC
	INVALID_SVC_CALL
KERNERROR	None
PURGED	None

**Note:** For more detail, refer to the explanation of RESPONSE and REASON in "Making an XPI call" on page 308.



## The TRANSACTION\_DUMP call

TRANSACTION\_DUMP causes a transaction dump to be taken. If the transaction dump code that you supply on input is in the transaction dump code table, the dump may be suppressed and, optionally, a system dump may be taken. For information about the dump table and how it works, refer to the *CICS Problem Determination Guide* and SET TRANDUMPCODE, in the *CICS System Programming Reference* manual.

### Important

There is a restriction in using the XPI early during initialization. Do not start exit programs that use the XPI functions TRANSACTION\_DUMP, WRITE\_JOURNAL\_DATA, MONITOR, and INQUIRE\_MONITOR\_DATA until the second phase of the PLTPI. For further information about the PLTPI, refer to Chapter 4, "Writing initialization and shutdown programs," on page 425.

### TRANSACTION\_DUMP

```
DFHDUDUX [CALL,]
          [CLEAR,]
          [IN,
          FUNCTION(TRANSACTION_DUMP),
          TRANSACTION_DUMPCODE(name4 | string | 'string')
          [CSA(NO|YES),]
          [PROGRAM(NO|YES),]
          [SEGMENT(b|ock-descriptor),]
          [SEGMENT_LIST(block-descriptor),]
          [TCA(NO|YES),]
          [TERMINAL(NO|YES),]
          [TRANSACTION(NO|YES),]
          [TRT(NO|YES),]]
          [OUT,
          DUMPID(name9 | *),
          RESPONSE(name1 | *),
          REASON(name1 | *)]
```

**Note:** This command is **NOT** threadsafe.

#### CSA(NO|YES)

specifies whether the common system area (CSA) is to be included in the transaction dump. The default is NO.

#### DUMPID(name9 | \*)

returns the dump identifier.

#### name9

The name of a 9-byte field to receive the assigned ID.

#### PROGRAM(NO|YES)

specifies whether all program storage areas associated with this task are to be included in the transaction dump. The default is NO.

#### SEGMENT(b|ock-descriptor)

specifies the address and the length of a single block of storage that is to be dumped. See block-descriptor for a description of valid block-descriptors. SEGMENT and SEGMENT\_LIST are mutually exclusive.

#### SEGMENT\_LIST(b|ock-descriptor)

specifies the address and length of a *set* of contiguous word pairs. The first word in each pair specifies the **length** in bytes of a storage segment to be dumped; the second word contains the **address** of the storage segment. The

end of the list must be marked by a word containing X'FFFFFFFF'. SEGMENT and SEGMENT\_LIST are mutually exclusive.

**TCA**(NO|YES)

specifies whether the task control area (TCA) is to be included in the transaction dump. The default is NO.

**TERMINAL**(NO|YES)

specifies whether all terminal storage areas associated with the task are to be included in the transaction dump. The default is NO.

**TRANSACTION**(NO|YES)

specifies whether all transaction storage areas associated with the task are to be included in the transaction dump. The default is NO.

**TRANSACTION\_DUMP**CODE(name4 | string | "string")

specifies the code corresponding to the error that caused this transaction dump call. Transaction dump codes are held in the dump table; for information about the dump table and how it works, refer to the *CICS Problem Determination Guide* and SET TRANDUMPCODE, in the *CICS System Programming Reference* manual.

**name4**

The name of a location containing a 4-byte string.

**string**

A string of characters without intervening blanks. The macro generates a literal constant of length 4 bytes from the string, extending with blanks or truncating as required.

**"string"**

A string, enclosed in quotation marks and possibly containing blanks. This value is processed in the same way as the "string" above.

**TRT**(NO|YES)

specifies whether the trace table (TRT) is to be included in the transaction dump. The default is NO.

**RESPONSE and REASON values for TRANSACTION\_DUMP:**

<i>RESPONSE</i>	<i>REASON</i>
OK	None
EXCEPTION	FESTAE_FAILED
	INSUFFICIENT_STORAGE
	IWMWQWRK_FAILED
	NOT_OPEN
	OPEN_ERROR
	PARTIAL_SYSTEM_DUMP
	PARTIAL_TRANSACTION_DUMP
	SDUMP_BUSY
	SDUMP_FAILED
	SDUMP_NOT_AUTHORIZED
	SUPPRESSED_BY_DUMPOPTION
	SUPPRESSED_BY_DUMPTABLE
	SUPPRESSED_BY_USEREXIT
DISASTER	None
INVALID	INVALID_DUMPCODE
	INVALID_PROBDESC
	INVALID_SVC_CALL
KERNERROR	None
PURGED	None

**Note:**

1. For more detail, refer to the explanation of RESPONSE and REASON in “Making an XPI call” on page 308.
2. ‘NOT\_OPEN’ means that the CICS dump data set is closed.
3. ‘OPEN\_ERROR’ means that an error occurred while a CICS dump data set was being opened.
4. ‘PARTIAL’ means that the transaction dump resulting from this request is incomplete.

---

## Enqueue domain XPI functions

There are two XPI enqueue domain functions. These are the DFHNQEDX macro calls ENQUEUE and DEQUEUE.

### The ENQUEUE function

The ENQUEUE functions is provided on the DFHNQEDX macro call. It allows you to enqueue on a named resource.

All enqueues created by XPI ENQUEUE commands are allocated to a specific enqueue pool called “DISPATCH” and are treated as internal to CICS. Thus XPI enqueues do not conflict with enqueues created by EXEC CICS ENQ commands, which are added to different enqueue pools, depending on the enqueue model specified. For example, an active EXEC CICS ENQ on a string does not prevent an XPI ENQUEUE on the same string being obtained. Furthermore:

- XPI enqueues cannot be browsed using the CICS SPI.
- XPI enqueues cannot be controlled by the use of ENQMODELS.

### ENQUEUE

```
DFHNQEDX [CALL,]
          [CLEAR,]
          [IN,
          FUNCTION(ENQUEUE),
          ENQUEUE_NAME1(address,length),
          [ENQUEUE_NAME2(address,length),]
          MAX_LIFETIME(DISPATCHER_TASK),
          [WAIT(YES|NO),]
          [PURGEABLE(YES|NO),]]
          [OUT,
          [ENQUEUE_TOKEN(name4),]
          [DUPLICATE_REQUEST,]
          RESPONSE (name1 | *),
          REASON(name1 | *)]
```

This command is threadsafe.

#### DUPLICATE\_REQUEST

indicates that the requesting dispatcher task already owns the resource being enqueued.

#### ENQUEUE\_NAME1(address,length)

specifies the high-order part of name to be enqueued.

#### ENQUEUE\_NAME2(address,length)

specifies the low-order part, if any, of name to be enqueued.

#### ENQUEUE\_TOKEN(name4)

enables a subsequent DEQUEUE request to identify the resource by a token

rather than enqueue name, allowing the NQ domain to locate the enqueue control block directly, and hence more efficiently.

#### **MAX\_LIFETIME(DISPATCHER\_TASK)**

MAX\_LIFETIME(DISPATCHER\_TASK) is required and specifies that all XPI enqueues are owned by the requesting dispatcher task.

If you use the ENQUEUE XPI call to ensure that your global user exit programs are threadsafe, you are recommended to free (dequeue) resources during the invocation of the global user exit program in which they were enqueued. However, as no recovery services are provided for abending global user exits, CICS ensures that any outstanding XPI enqueues are dequeued automatically when the dispatcher task terminates. Note that if the dispatcher task is running a CICS transaction, the dispatcher task terminates when the CICS transaction terminates (whether normally or abnormally).

Normally enqueues are owned by the requesting transaction, which contains units of work (UOWs), and these are used to anchor the enqueue control blocks. The XPI, however, does not require a transaction environment, and global user exits may be invoked under dispatcher tasks which have no transactions or UOWs.

#### **PURGEABLE(YES|NO)**

specifies whether a purge (or timeout) request against the task is to be honored if the requesting dispatcher task has to wait for the enqueue.

#### **WAIT(YES|NO)**

specifies whether the dispatcher task is to wait if the resource is currently enqueued to another dispatcher task.

### **RESPONSE and REASON values for ENQUEUE**

<i>RESPONSE</i>	<i>REASON</i>
OK	None
EXCEPTION	ENQUEUE_BUSY ENQUEUE_LOCKED ENQUEUE_DISABLED LIMIT_EXCEEDED SYSENQ_FAILURE
PURGED	TASK_CANCELLED TIMED_OUT

## **The DEQUEUE function**

The DEQUEUE function is provided on the DFHNQEDX macro call. It releases a resource previously enqueued by an ENQUEUE function call.

### **DEQUEUE**

```
DFHNQEDX [CALL,]  
    [CLEAR,]  
    [IN,  
    FUNCTION(DEQUEUE),  
    {ENQUEUE_TOKEN(name4), |  
    ENQUEUE_NAME1(address,length), [ENQUEUE_NAME2(address,length), ]}  
    MAX_LIFETIME(DISPATCHER_TASK), ]  
    [OUT,  
    RESPONSE (name1 | *),  
    REASON(name1 | *)]
```

This command is threadsafe.

The ENQUEUE\_TOKEN, ENQUEUE\_NAME1, ENQUEUE\_NAME2, and MAX\_LIFETIME(DISPATCHER\_TASK) parameters are the same as in the ENQUEUE function call.

### RESPONSE and REASON values for DEQUEUE

<i>RESPONSE</i>	<i>REASON</i>
OK	None
EXCEPTION	ENQUEUE_NOT_OWNED ENQUEUE_LOCKED

---

## Kernel domain XPI functions

### The START\_PURGE\_PROTECTION function

The START\_PURGE\_PROTECTION function is provided on the DFHKEDSX macro call. It inhibits purge, but not force-purge, for the current task. This function can be used by all global user exit programs if they want to inhibit purge during a global user exit call.

In general, each START\_PURGE\_PROTECTION call should have a corresponding STOP\_PURGE\_PROTECTION function call to end the purge protection period on completion of any program logic that needs such protection.

#### START\_PURGE\_PROTECTION

```
DFHKEDSX [CALL,]
          [CLEAR,]
          [IN,
          FUNCTION(START_PURGE_PROTECTION),]
          [OUT,
          RESPONSE (name1 | *)]
```

This command is threadsafe.

There are no input or output parameters on this call, only a RESPONSE.

#### RESPONSE values for START\_PURGE\_PROTECTION:

<i>RESPONSE</i>	<i>REASON</i>
OK	None
DISASTER	None
INVALID	None

### The STOP\_PURGE\_PROTECTION function

The STOP\_PURGE\_PROTECTION function is provided on the DFHKEDSX macro call. It re-enables purge for the current task after purge has been suspended by a preceding START\_PURGE\_PROTECTION function call.

## STOP\_PURGE\_PROTECTION

```
DFHKEDSX [CALL,]  
          [CLEAR,]  
          [IN,  
          FUNCTION(STOP_PURGE_PROTECTION),]  
          [OUT,  
          RESPONSE (name1 | *)]
```

This command is threadsafe.

There are no input or output parameters on this call, only a RESPONSE.

### RESPONSE values for STOP\_PURGE\_PROTECTION:

<i>RESPONSE</i>	<i>REASON</i>
OK	None
DISASTER	None
INVALID	None

## Nesting purge protection calls

Note that the START\_ and STOP\_PURGE\_PROTECTION functions can be nested. You should ensure that, if multiple START\_PURGE\_PROTECTION calls are issued for a task, that the correct number of STOP\_PURGE\_PROTECTION calls are issued to cancel the purge protection. If you issue two starts and only one stop, purge protection is left on for the current task.

For example, for any current task, more than one global user exit program may be driven. You must design your exit programs to ensure that purge protection is correctly cancelled. An example of nesting is shown as follows:

```
XEIIN:  
  EXIT_PROG1: Calls START_PURGE_PROTECTION  
  
  XFCREQ:  
    EXIT_PROG2: Calls START_PURGE_PROTECTION  
  
  XFCREQC:  
    EXIT_PROG3: Calls STOP_PURGE_PROTECTION  
  
XEIOUT:  
  EXIT_PROG4: Calls STOP_PURGE_PROTECTION
```

---

## Loader XPI functions

There are four XPI loader functions. These are the DFHLDLDX calls ACQUIRE\_PROGRAM, RELEASE\_PROGRAM, DEFINE\_PROGRAM, and DELETE\_PROGRAM.

**DFHLDLDX calls cannot be used** in any exit program invoked from any global user exit point in the:

- Statistics domain
- Monitor domain
- Dump domain
- Dispatcher domain
- Transient data program.

## The DEFINE\_PROGRAM call

DEFINE\_PROGRAM allows you to define new programs to the loader domain, or to change the details of programs that have already been defined. The details that you provide are recorded on the local catalog, and become immediately available. They are used on all subsequent ACQUIRE requests for the named program. However, note that program definitions made in this way are **not** retained over an XRF takeover. Also, the CSD is not updated, only the loader domain definitions.

### DEFINE\_PROGRAM

```
DFHLDLX [CALL,]
  [CLEAR,]
  [IN,
  FUNCTION(DEFINE_PROGRAM),
  PROGRAM_NAME(name8 | string | 'string' ),
  [EXECUTION_KEY(CICS|USER),]
  [PROGRAM_ATTRIBUTE(RELOAD|RESIDENT|REUSABLE|TRANSIENT),]
  [PROGRAM_TYPE(PRIVATE|SHARED|TYPE_ANY),]
  [REQUIRED_AMODE(24|31|AMODE_ANY),]
  [REQUIRED_RMODE(24|RMODE_ANY),]]
  [OUT,
  [NEW_PROGRAM_TOKEN(name4),]
  RESPONSE(name1 | *),
  REASON(name1 | *)]
```

This command is threadsafe.

#### EXECUTION\_KEY(CICS|USER)

specifies, in conjunction with other program attributes, the type of dynamic storage area (DSA) into which the loader is to load the program.

**CICS** For non-reentrant programs, means that the program is to be loaded into a CICS DSA, above or below the 16MB line; that is, the CDSA or ECDSA. The choice of CICS DSA is dependent on the residence mode (RMODE) attribute of the program as defined to the linkage-editor.

For reentrant RMODE(24) programs, means that the program is to be loaded into the CDSA.

**USER** For non-reentrant programs, means that the program is to be loaded into a user DSA, above or below the 16MB line; that is, the UDSA or EUDSA. The choice of user DSA is dependent on the residence mode (RMODE) attribute of the program as defined to the linkage-editor.

For reentrant RMODE(24) programs, means that the program is to be loaded into the UDSA.

**Reentrant programs eligible to reside above the 16MB line:** If a program is link-edited as reentrant with AMODE(31),RMODE(ANY), the EXECUTION\_KEY option is ignored, and it is loaded into a read-only DSA (the RDSA or ERDSA). For details of the type of storage allocated for the ERDSA, see the RENTPGM system initialization parameter.

See Table 19 for a summary of the effect of the EXECUTION\_KEY option in conjunction with other factors.

Table 19. Summary of attributes defining DSA eligibility

EXECUTION_KEY option	Reentrant	Above or below 16MB line	Dynamic storage area (DSA)
CICS	No	Below	CDSA

Table 19. Summary of attributes defining DSA eligibility (continued)

EXECUTION_KEY option	Reentrant	Above or below 16MB line	Dynamic storage area (DSA)
CICS	Yes	Below	RDSA
CICS	No	Above	ECDSA
CICS	Yes	Above	ERDSA
USER	No	Below	UDSA
USER	Yes	Below	RDSA
USER	No	Above	EUDSA
USER	Yes	Above	ERDSA

**NEW\_PROGRAM\_TOKEN(name4)**

returns the token supplied for the newly-defined program.

**name4**

The name of a location to contain the 4-byte token obtained.

**PROGRAM\_ATTRIBUTE(RELOAD|RESIDENT|REUSABLE|TRANSIENT)**

specifies the residency status of the program.

**RELOAD**

Every ACQUIRE\_PROGRAM request for this program is satisfied by loading a new copy into storage. When a RELEASE request is issued for a copy, it is removed from storage.

**Note:** Do not use this attribute when defining an exit program.

**RESIDENT**

There is a single copy of the program that is not removed from storage unless deleted. RESIDENT programs must be at least quasireentrant.

**REUSABLE**

The program is at least quasireentrant; a single copy in storage can be used by several tasks in the system. A REUSABLE program becomes eligible for removal from storage as part of the normal dynamic program compression scheme when its use count reaches zero.

**TRANSIENT**

Similar to REUSABLE, except that the program is removed from storage immediately its use count reaches zero. This should be specified only for less-frequently used programs, or for programs in systems that are critically short on storage.

**PROGRAM\_NAME(name8 | string | "string")**

specifies the name of the program to be defined.

**name8**

The name of a location where there is an 8-byte program name.

**string** A string of characters, without intervening blanks, naming the program.

**"string"**

A string of characters within quotation marks. The string length is set to 8 by padding with blanks or by truncation.

**PROGRAM\_TYPE(PRIVATE|SHARED|TYPE\_ANY)**

specifies where to load the program from.



## PRIVATE

The program is in the DFHRPL or dynamic LIBRARY concatenation. A PRIVATE program need not be reentrant, and is given only limited protection from unauthorized overwriting. The degree of protection depends on the type of dynamic storage area (DSA) into which the program is loaded (see the EXECUTION\_KEY option):

### **DSA Protection from unauthorized overwriting**

**CDSA** Cannot be overwritten by USER tasks

### **ECDSA**

Cannot be overwritten by USER tasks

### **ERDSA**

Complete—cannot be overwritten by USER tasks or CICS tasks

### **EUDSA**

None

**RDSA** Complete—cannot be overwritten by USER tasks or CICS tasks

**UDSA** None.

## SHARED

The program is located in the link pack area (LPA), is reentrant, and is protected.

## TYPE\_ANY

Either the copy in DFHRPL or dynamic LIBRARY concatenation, or the LPA copy of the program may be used, though preference is given to the LPA copy.

## REQUIRED\_AMODE (24|31|AMODE\_ANY)

specifies the addressing mode of the program. If, during subsequent ACQUIRE\_PROGRAM processing, no copy of the program that meets the defined addressing requirement can be found, the ACQUIRE\_PROGRAM call receives an 'EXCEPTION' response and the REASON value 'PROGRAM\_NOT\_FOUND'.

### **Note:**

1. AMODE\_ANY and AMODE 31 have identical meanings for this function.
2. You cannot use this option to override the link-edited addressing mode of the program.

## REQUIRED\_RMODE (24|RMODE\_ANY)

specifies the residency mode of the program. If, during subsequent ACQUIRE\_PROGRAM processing, no copy of the program that meets the defined addressing requirement can be found, the ACQUIRE\_PROGRAM call receives an 'EXCEPTION' response and the REASON value 'PROGRAM\_NOT\_FOUND'.

**Note:** You cannot use this option to override the link-edited residence mode of the program.

## RESPONSE and REASON values for DEFINE\_PROGRAM:

<i>RESPONSE</i>	<i>REASON</i>
OK	None
EXCEPTION	CATALOG_ERROR

<i>RESPONSE</i>	<i>REASON</i>
DISASTER	CATALOG_NOT_OPERATIONAL
INVALID	None
KERNERROR	None
PURGED	None

**Note:** For more detail, refer to the explanation of RESPONSE and REASON in “Making an XPI call” on page 308.

## The ACQUIRE\_PROGRAM call

ACQUIRE\_PROGRAM returns the entry and load point addresses, the length, and a new program token for a usable copy of the named program, which can be identified by either its name or a program token.

### ACQUIRE\_PROGRAM

```
DFHLDLX [CALL,]
  [CLEAR,]
  [IN,
  FUNCTION(ACQUIRE_PROGRAM),
  {PROGRAM_NAME(name8 | string | 'string')|
  PROGRAM_TOKEN(name4)},
  [SUSPEND(NO|YES),]
  [OUT,
  ENTRY_POINT(name4 | (Ra)),
  [LOAD_POINT(name4 | (Ra)),]
  [NEW_PROGRAM_TOKEN(name4),]
  [PROGRAM_ATTRIBUTE(name1 | (Rn)),]
  [PROGRAM_LENGTH(name4 | (Rn)),]
  RESPONSE(name1 | *),
  REASON(name1 | *)]
```

This command is threadsafe.

#### ENTRY\_POINT(name4 | (Ra))

returns the program's entry point address.

##### name4

The name of a 4-byte location to receive the 31-bit entry address

**(Ra)** A register to receive the entry address.

#### LOAD\_POINT(name4 | (Ra))

returns the program's load point address.

##### name4

The name of a 4-byte location to receive the loaded address

**(Ra)** A register that is to contain the load address.

#### NEW\_PROGRAM\_TOKEN(name4)

returns the new program token for a usable copy of the named program.

##### name4

The name of a location to receive a 4-byte token that identifies this program and instance.

#### PROGRAM\_ATTRIBUTE(name1 | (Rn))

returns the program attribute.

**name1**

The name of a 1-byte location to receive the program attribute.

**(Rn)** A register in which the low-order byte receives the program attribute and the other bytes are set to zero. It can have the values RELOAD, RESIDENT, REUSABLE, or TRANSIENT.

**RELOAD**

The program is not reusable, and therefore several copies of the program may be loaded. A copy is removed from storage when a RELEASE\_PROGRAM call (for that copy) is issued.

**RESIDENT**

There is a single copy of the program that is not removed from storage unless deleted. RESIDENT programs must be at least quasireentrant. Any program of PROGRAM\_TYPE SHARED has the RESIDENT attribute by default. The DELETE\_PROGRAM call has no effect on this type of RESIDENT program.

**REUSABLE**

Similar to RESIDENT, except that a REUSABLE program that is not in use can be removed from storage by CICS, for storage optimization reasons.

**TRANSIENT**

Similar to RESIDENT, except that a TRANSIENT program is removed from storage as soon as its use count drops to zero.

**PROGRAM\_LENGTH(name4 | (Rn))**

returns the length of the named program.

**name4**

The name of a 4-byte location that is to receive the length in bytes, expressed in binary

**(Rn)** A register to contain the length in bytes, expressed in binary.

**PROGRAM\_NAME(name8 | string | "string")**

specifies the name of the program to be acquired.

**name8**

The name of a location containing an 8-byte program name.

**string** A string of characters naming the program.

**"string"**

A string in quotation marks. The string length is set to 8 by padding with blanks or truncating.

**PROGRAM\_TOKEN(name4),**

specifies a token identifying the program whose details are to be acquired.

**name4**

The name of a location containing a 4-byte token obtained by a previous DEFINE\_PROGRAM or ACQUIRE\_PROGRAM call.

**SUSPEND(NO|YES)**

specifies whether execution is to be suspended until the request can be granted.

## RESPONSE and REASON values for ACQUIRE\_PROGRAM:

<i>RESPONSE</i>	<i>REASON</i>
OK	None
EXCEPTION	NO_STORAGE PROGRAM_NOT_DEFINED PROGRAM_NOT_FOUND
DISASTER	None
INVALID	None
KERNERROR	None
PURGED	None

### Note:

1. For more detail, refer to the explanation of RESPONSE and REASON in “Making an XPI call” on page 308.
2. A REASON of ‘NO\_STORAGE’ with a RESPONSE of ‘EXCEPTION’ means that there was insufficient storage to satisfy this request, and SUSPEND(NO) was specified.
3. A REASON of ‘PROGRAM\_NOT\_FOUND’ is returned if the program has not been included in the library concatenation, or if the link-edit failed. In such a case, the program is marked as “not executable”; it must be re-linked before it can be successfully acquired.

## The RELEASE\_PROGRAM call

RELEASE\_PROGRAM decrements the use count of a currently loaded program by one.

If the program has been defined with the RELOAD attribute, the storage occupied by this copy of the program is released.

You should issue the ACQUIRE\_PROGRAM and RELEASE\_PROGRAM requests for a single program during the same execution of the exit program. If you do not want to do this, you should acquire the program once during CICS initialization, and leave it resident until CICS termination.

### RELEASE\_PROGRAM

```
DFHLDLX [CALL,]
        [CLEAR,]
        [IN,
        FUNCTION(RELEASE_PROGRAM),
        ENTRY_POINT(pointer),
        {PROGRAM_NAME(name8 | string | 'string')|
        PROGRAM_TOKEN(name4)},]
        [OUT,
        RESPONSE(name1 | *),
        REASON(name1 | *)]
```

This command is threadsafe.

#### **ENTRY\_POINT(pointer)**

specifies the address of the entry point of this copy of the named program.

#### **PROGRAM\_NAME(name8 | string | "string")**

specifies the name of the program to be released.

**name8**

The name of a location containing an 8-byte program name.

**string** A string of characters naming the program.

**"string"**

A string in quotation marks. The string length is set to 8 by padding with blanks or truncating.

**PROGRAM\_TOKEN(name4),**

specifies a token identifying the program to be released.

**name4**

The name of a location containing an 4-byte token obtained by a previous DEFINE\_PROGRAM or ACQUIRE\_PROGRAM call.

**RESPONSE and REASON values for RELEASE\_PROGRAM:**

<i>RESPONSE</i>	<i>REASON</i>
OK	None
EXCEPTION	PROGRAM_NOT_DEFINED
	PROGRAM_NOT_IN_USE
DISASTER	None
INVALID	None
KERNERROR	None
PURGED	None

**Note:**

1. For more detail, refer to the explanation of RESPONSE and REASON in "Making an XPI call" on page 308.
2. 'PROGRAM\_NOT\_DEFINED' is returned if the program that you name is not known to the system.
3. 'PROGRAM\_NOT\_IN\_USE' is returned when the use count for the named program is already zero.

**The DELETE\_PROGRAM call**

DELETE\_PROGRAM removes the definition of a named program from the catalog and from the list of current programs. When this request executes successfully, subsequent ACQUIRE\_PROGRAM requests fail with a REASON value of 'PROGRAM\_NOT\_DEFINED'.

**DELETE\_PROGRAM**

```
DFHLDLX [CALL,]
  [CLEAR,]
  [IN,
  FUNCTION(DELETE_PROGRAM),
  PROGRAM_NAME(name8 | string | 'string' ),]
  [OUT,
  RESPONSE(name1 | *),
  REASON(name1 | *)]
```

This command is threadsafe.

**PROGRAM\_NAME(name8 | string | "string")**

specifies the name of the program to be deleted.

**name8**

The name of a location containing an 8-byte program name.

**string** A string of characters naming the program.

**"string"**

A string in quotation marks. The string length is set to 8 by padding with blanks or truncating.

### **RESPONSE and REASON values for DELETE\_PROGRAM:**

<i>RESPONSE</i>	<i>REASON</i>
OK	None
EXCEPTION	PROGRAM_NOT_DEFINED
DISASTER	None
INVALID	None
KERNERROR	None
PURGED	None

**Note:** For more detail, refer to the explanation of RESPONSE and REASON in “Making an XPI call” on page 308.

---

## **Log manager XPI functions**

There are two XPI log manager functions. These are the DFHLGPAX calls:

- INQUIRE\_PARAMETERS
- SET\_PARAMETERS

These calls allow you to inquire upon, and set, the log manager parameter, KEYPOINT\_FREQUENCY. The value in this parameter specifies the activity keypoint frequency of the CICS region.

### **The INQUIRE\_PARAMETERS call**

INQUIRE\_PARAMETERS returns information about the activity keypoint frequency of the system.

#### **INQUIRE\_PARAMETERS**

```
DFHLGPAX [CALL,]  
  [CLEAR,]  
  [IN,  
  FUNCTION(INQUIRE_PARAMETERS),  
  [OUT,  
  [KEYPOINT_FREQUENCY(name4 | *),]  
  RESPONSE(name1 | *),  
  REASON(name1 | *)]
```

This command is threadsafe.

**KEYPOINT\_FREQUENCY(name4 | \*)**

returns the activity keypointing frequency of the CICS region.

**name4**

The name of a 4-byte location that is to receive the frequency value.

### **RESPONSE and REASON values for INQUIRE\_PARAMETERS:**

<i>RESPONSE</i>	<i>REASON</i>
OK	None
DISASTER	None

<i>RESPONSE</i>	<i>REASON</i>
INVALID	None
KERNERROR	None

## The SET\_PARAMETERS call

SET\_PARAMETERS allows you to set the activity keypoint frequency for the CICS region.

### SET\_PARAMETERS

```
DFHLGPAX [CALL,]
          [CLEAR,]
          [IN,
          FUNCTION(SET_PARAMETERS),
          [KEYPOINT_FREQUENCY(name4 | (Rn) ),]]
          [OUT,
          RESPONSE(name1 | *),
          REASON(name1 | *)]
```

This command is threadsafe.

#### KEYPOINT\_FREQUENCY(name4 | \*)

specifies the activity keypointing frequency of the CICS region.

Permitted values are 0, or any integer between 200 and 65535 inclusive.

#### name4

The name of a 4-byte location that contains the new frequency value.

**(Rn)** A register that contains the new frequency value.

### RESPONSE and REASON values for SET\_PARAMETERS:

<i>RESPONSE</i>	<i>REASON</i>
OK	None
EXCEPTION	OUT_OF_RANGE
DISASTER	None
INVALID	None
KERNERROR	None

**Note:** For more detail, refer to the explanation of RESPONSE and REASON in “Making an XPI call” on page 308.

---

## Monitoring XPI functions

There are two XPI monitoring functions. These are the DFHMNMNX calls MONITOR and INQUIRE\_MONITORING\_DATA.

**DFHMNMNX calls cannot be used** in any exit program invoked from any global user exit point in the:

- Dispatcher domain
- Dump domain
- Monitor domain
- Statistics domain
- Transient data program.

**INQUIRE\_MONITORING\_DATA** calls cannot be used in any exit program invoked from any global user exit point in DFHTCP or DFHZCP (that is, at any of the exit points named “XTCx...” or “XZCx...”).

## The MONITOR call

The MONITOR XPI call is similar to the EXEC CICS MONITOR command. It enables you to invoke user event-monitoring points (EMPs) in your exit programs. The user event-monitoring points must be defined in the monitoring control table (MCT) using the DFHMCT TYPE=EMP macro, or generated by the APPLNAME parameter on the DFHMCT TYPE=INITIAL macro. For more information about CICS monitoring, read Chapter 28, “CICS monitoring,” on page 743.

At a user EMP, you can add your own data (up to 256 counters, up to 256 clocks, and a single character string of up to 256 bytes) to fields reserved unconditionally for you in performance class monitoring data records. You can also add up to 12 bytes of user information at the DFHAPPL EMPs.

### MONITOR

```
DFHMNMNX [CALL,]
  [CLEAR,]
  [IN,
  FUNCTION(MONITOR),
  POINT(expression | name2 | (Rn)),
  [DATA1(expression | name4 | (Ra) | *),]
  [DATA2(expression | name4 | (Ra) | *),]
  [ENTRYNAME(name8 | string | 'string'),]
  [OUT,
  RESPONSE(name1 | *),
  REASON(name1 | *)]
```

This command is threadsafe.

### Important

There is a restriction in using the XPI early during initialization. Do not start exit programs that use the XPI functions TRANSACTION\_DUMP, WRITE\_JOURNAL\_DATA, MONITOR, and INQUIRE\_MONITORING\_DATA until the second phase of the PLTPI. For further information about the PLTPI, refer to Chapter 4, “Writing initialization and shutdown programs,” on page 425.

#### **DATA1(expression | name4 | (Ra) | \*)**

specifies a fullword binary variable whose contents depend on the type of user EMP being used:

- If the MCT user EMP definition contains an ADDCNT, SUBCNT, NACNT, EXCNT, or ORCNT option, the DATA1 variable is an area used as defined by the user EMP definition.
- If the MCT user EMP definition contains an MLTCNT option, the DATA1 variable is an area with the address of a series of adjacent fullwords containing the values to be added to the user count fields defined in the user EMP definition.
- If the MCT user EMP definition contains a MOVE option, the DATA1 variable is an area with the address of the character string to be moved. This rule also applies to the DFHAPPL EMPs.

For details of the user EMP options, see User event monitoring points—DFHMCT TYPE=EMP, in the *CICS Resource Definition Guide*.



**expression**

A valid assembler-language expression giving the fullword binary variable for this EMP.

**name4**

The name of a 4-byte field containing the fullword binary variable for this EMP.

**(Ra)** A register containing the fullword binary variable for this EMP.

\* The value of this option is already present in the parameter list, or the option is not specified for this EMP.

**DATA2(expression | name4 | (Rn) | \*)**

specifies a fullword binary variable whose contents depend on the type of user EMP being used:

- If the MCT user EMP definition contains an ADDCNT, SUBCNT, NACNT, EXCNT, or ORCNT option, the DATA2 variable is an area used as defined by the user EMP definition.

- If the MCT user EMP definition contains an MLTCNT option, the DATA2 variable is an area with the number of user count fields to be updated.

The number specified in DATA2 overrides the default value defined in the MCT for the operation. A value of 0 instructs monitoring to use the default. Not specifying a value for DATA2 does not prevent the MLTCNT operation from being successful; but, if it is, an exception response of 'DATA2\_NOT\_SPECIFIED' is returned. See note 5.

- If the MCT user EMP definition contains a MOVE option, the DATA2 variable is an area with the length of the character string to be moved.

The length specified in DATA2 overrides the default value defined in the MCT for the operation. A value of 0 instructs monitoring to use the default. Not specifying a value for DATA2 does not prevent the MOVE operation from being successful; but, if it is, an exception response of 'DATA2\_NOT\_SPECIFIED' is returned. See note 5.

For details of the user EMP options, see User event monitoring points—DFHMCT TYPE=EMP, in the *CICS Resource Definition Guide*.

**expression**

A valid assembler-language expression giving the fullword binary variable for this EMP.

**name4**

The name of a 4-byte field containing the fullword binary variable for this EMP.

**(Rn)** A register containing the fullword binary variable for this EMP.

\* The value of this option is already present in the parameter list, or the option is not specified for this EMP.

**ENTRYNAME(name8 | string | "string")**

specifies the monitoring point entry name, which qualifies the POINT value and which is defined in the monitoring control table (MCT).

**name8**

The name of a location containing an 8-byte string.

**string** A string of characters without intervening blanks. The macro generates, from the string, a literal constant of length 8 bytes, extending with blanks or truncating as required.

**"string"**

A string, enclosed in quotation marks, and possibly containing blanks. This value is processed in the same way as the "string" above.

**Note:** If, when defining the EMP in the MCT, you do not specify an entry name, the entry name defaults to 'USER'. ENTRYNAME likewise defaults to 'USER' if not specified.

**POINT(expression | name2 | (Rn))**

specifies the monitoring point identifier as defined in the MCT, and is in the range 0 through 255. Note, however, that point identifiers in the range 200 through 255 are reserved for use by IBM program products.

**expression**

A valid assembler-language expression that can be expressed in 2 bytes.

**name2**

The name of a 2-byte source of point data

**(Rn)** A register containing the point data in the low-order 2 bytes

**RESPONSE and REASON values for MONITOR:**

<i>RESPONSE</i>	<i>REASON</i>
OK	None
EXCEPTION	DATA1_NOT_SPECIFIED
	DATA2_NOT_SPECIFIED
	POINT_NOT_DEFINED
	INVALID_DATA1_VALUE
	INVALID_DATA2_VALUE
DISASTER	None
INVALID	None
KERNERROR	None
PURGED	None

**Note:**

1. For more detail, refer to the explanation of RESPONSE and REASON in "Making an XPI call" on page 308.
2. 'POINT\_NOT\_DEFINED' means that the EMP you have specified was not defined in the MCT.
3. 'INVALID\_DATA1\_VALUE' and 'INVALID\_DATA2\_VALUE' are most likely to have been caused by provision of bad addresses; this causes a program check.
4. DATA1\_NOT\_SPECIFIED and DATA2\_NOT\_SPECIFIED mean that you have not specified DATA1 or DATA2 respectively when the operation required them. See the description of DATA2.
5. Any error response terminates processing of the EMP. Operations defined to execute before the point of failure will have done so; later operations are canceled.

**The INQUIRE\_MONITORING\_DATA call**

The INQUIRE\_MONITORING\_DATA function returns to the exit program the performance class monitoring data that has been accumulated for the issuing task.

The DFHMNTDS DSECT that maps the data is of fixed format. Note that:

- All the CICS system-defined fields in the performance records (including fields that you have specified for exclusion using the EXCLUDE option of the DFHMCT TYPE=RECORD macro) are listed.
- No user-defined data fields are listed.

## INQUIRE\_MONITORING\_DATA

```
DFHMNMN [CALL,]
          [CLEAR,]
          [IN,
           FUNCTION(INQUIRE_MONITORING_DATA),
           DATA_BUFFER(buffer-descriptor),]
          [OUT,
           RESPONSE(name1 | *),
           REASON(name1 | *)]
```

This command is threadsafe.

### Important

There is a restriction in using the XPI early during initialization. Do not start exit programs that use the XPI functions TRANSACTION\_DUMP, WRITE\_JOURNAL\_DATA, MONITOR, and INQUIRE\_MONITOR\_DATA until the second phase of the PLTPI. For further information about the PLTPI, refer to Chapter 4, “Writing initialization and shutdown programs,” on page 425.

#### DATA\_BUFFER(buffer-descriptor)

specifies the address and the length of a buffer to contain the returned monitoring data; see buffer-descriptor for a full definition of a buffer-descriptor. The DSECT DFHMNTDS maps the monitoring data.

### RESPONSE and REASON values for INQUIRE\_MONITORING\_DATA:

<i>RESPONSE</i>	<i>REASON</i>
OK	None
EXCEPTION	LENGTH_ERROR MONITOR_DATA_UNAVAILABLE
DISASTER	None
INVALID	None
KERNERROR	None
PURGED	None

#### Note:

1. For more detail, refer to the explanation of RESPONSE and REASON in “Making an XPI call” on page 308.
2. ‘LENGTH\_ERROR’ means that the length specified in the buffer-descriptor was too short for the monitoring data returned from the XPI call.

---

## Program management XPI functions

There are eight XPI program management functions. These are the DFHPGISX calls:

```
INQUIRE_PROGRAM
INQUIRE_CURRENT_PROGRAM
SET_PROGRAM
START_BROWSE_PROGRAM
GET_NEXT_PROGRAM
END_BROWSE_PROGRAM
```

and the DFHPGAQX calls:

```
INQUIRE_AUTOINSTALL
SET_AUTOINSTALL
```

Used with the Loader functions DEFINE\_PROGRAM, ACQUIRE\_PROGRAM, RELEASE\_PROGRAM, and DELETE\_PROGRAM, these calls give you a comprehensive set of tools for manipulating programs. (Note, however, that the tokens returned in the NEW\_PROGRAM\_TOKEN fields of DFHPGISX calls are different from those returned by DFHLDLDX Loader calls. You should not use a token obtained from a DFHPGISX call in a DFHLDLDX call, or vice versa.)

### The INQUIRE\_PROGRAM call

INQUIRE\_PROGRAM returns information about the attributes of a specified program.

#### INQUIRE\_PROGRAM

```
DFHPGISX [CALL,]
  [CLEAR,]
  [IN,
  FUNCTION(INQUIRE_PROGRAM),
  {PROGRAM_NAME(name8 | string | 'string')|
  PROGRAM_TOKEN(name4)},,]
  [OUT,
  [ACCESS(CICS|NONE|READ_ONLY|USER),]
  [APIST(CICSAPI|OPENAPI),]
  [AVAIL_STATUS(DISABLED|ENABLED),]
  [CEDF_STATUS(CEDF|NOCEDF|NOT_APPLIC),]
  [CONCURRENCY(QUASIRENT|THREADSAFE),]
  [DATA_LOCATION(ANY|BELOW|NOT_APPLIC),]
  [DYNAMIC_STATUS(DYNAMIC|NOT_DYNAMIC),]
  [ENTRY_POINT(name4),]
  [EXECUTION_KEY(CICS|NOT_APPLIC|USER),]
  [EXECUTION_SET(DPLSUBSET|FULLAPI|NOT_APPLIC),]
  [HOLD_STATUS(CICS_LIFE|NOT_APPLIC|TASK_LIFE),]
  [INSTALL_TYPE(AUTO|CATALOG|GROUPLIST|MANUAL|RDO|SYSAUTO),]
  [LANGUAGE_DEDUCED(ASSEMBLER|C370|COBOL|
                    COBOL2|LE370|NOT_APPLIC|NOT_DEDUCED|PLI),]
  [LANGUAGE_DEFINED(ASSEMBLER|C370|COBOL|
                    LE370|NOT_APPLIC|NOT_DEFINED|PLI),]
  [LIBRARY(name8),]
  [LIBRARYDSN(name44),]
  [LOAD_POINT(name4),]
  [LOAD_STATUS(LOADABLE|NOT_APPLIC|NOT_LOADABLE|NOT_LOADED),]
  [LOCATION(CDSA|ECDSA|ELPA|ERDSA|ESDSA|LPA|NONE|RDSA|SDSA),]
  [MODULE_TYPE(MAPSET|PARTITIONSET|PROGRAM),]
  [NEW_PROGRAM_TOKEN(name4),]
  [PROGRAM_ATTRIBUTE(RELOAD|RESIDENT|REUSABLE|TRANSIENT),]
```

```

[PROGRAM_LENGTH(name4),]
[PROGRAM_TYPE(NOT_APPLIC|PRIVATE|SHARED|TYPE_ANY),]
[PROGRAM_USAGE(APPLICATION|NUCLEUS),]
[PROGRAM_USE_COUNT(name4),]
[PROGRAM_USER_COUNT(name4),]
[REMOTE_DEFINITION(LOCAL|REMOTE),]
[REMOTE_PROGID(name8),]
[REMOTE_SYSID(name4),]
[REMOTE_TRANID(name4),]
[SPECIFIED_AMODE(24|31|AMODE_ANY|AMODE_NOT_SPECIFIED),]
[SPECIFIED_RMODE(24|RMODE_ANY|RMODE_NOT_SPECIFIED),]
RESPONSE(name1 | *),
REASON(name1 | *)]

```

This command is threadsafe.

**ACCESS(CICS|NONE|READ\_ONLY|USER)**

returns a value indicating the type of storage into which the program has been loaded.

**CICS** CICS-key

**NONE** The program has not been loaded

**READ\_ONLY**  
Readonly

**USER** User-key

**APIST(CICSAPI|OPENAPI)**

returns a value indicating the API attribute of the installed program definition.

**CICSAPI**

The program is restricted to use of the CICS permitted application programming interfaces only.

**OPENAPI**

The program is not restricted to use of the CICS permitted application programming interfaces only. It must be coded to threadsafe standards and defined with CONCURRENCY(THREADSAFE).

**AVAIL\_STATUS(DISABLED|ENABLED)**

returns a value indicating whether the program can be used—that is, whether or not it has been enabled.

**CEDF\_STATUS(CEDF|NOCEDF|NOT\_APPLIC)**

returns the EDF status of the program.

**CEDF** When the program is running under the control of the CICS execution diagnostic facility (EDF), EDF diagnostic screens are displayed.

**NOCEDF**  
EDF diagnostic screens are not displayed.

**NOT\_APPLIC**

Not applicable. This is a mapset, partitionset, or a remote program.

**CONCURRENCY(QUASIRENT|THREADSAFE)**

returns a value indicating the concurrency attribute of the installed program definition.

**QUASIRENT**

The program is defined as being quasi-reentrant, and is able to run only under the CICS QR TCB.

## **THREADSAFE**

The program is defined as threadsafe, and is able to run under whichever TCB is in use by its user task when the program is given control. This could be either an open TCB or the CICS QR TCB.

**Note:** In the case of a Language Environment-conforming program, the concurrency as originally defined can be overridden when the program is subsequently loaded.

## **DATA\_LOCATION(ANY|BELOW|NOT\_APPLIC)**

returns a value indicating whether or not the program can access data located above the 16MB line.

**ANY** The program can handle 31-bit addresses, and can therefore be passed data located above or below the 16MB line.

## **BELOW**

The program can handle only 24-bit addresses, and must therefore only be passed data located below the 16MB line.

## **NOT\_APPLIC**

Not applicable. This is a mapset, partitionset, or a remote program.

## **DYNAMIC\_STATUS(DYNAMIC|NOT\_DYNAMIC)**

returns a value indicating whether, if the program is the subject of a program-link request, the request can be dynamically routed.

## **DYNAMIC**

If the program is the subject of a program-link request, the CICS dynamic routing program is invoked. Providing that a remote server region is not named explicitly on the SYSID option of the EXEC CICS LINK command, the routing program can route the request to the region on which the program is to execute.

## **NOT\_DYNAMIC**

If the program is the subject of a program-link request, the dynamic routing program is not invoked.

For a distributed program link (DPL) request, the server region on which the program is to execute must be specified explicitly on the REMOTESYSTEM option of the PROGRAM definition or on the SYSID option of the EXEC CICS LINK command; otherwise it defaults to the local region.

For information about the dynamic routing of DPL requests, see the *CICS Intercommunication Guide*.

## **ENTRY\_POINT(name4)**

returns the program's entry point address, as it would be returned by a Loader domain ACQUIRE\_PROGRAM call.

## **EXECUTION\_KEY(CICS|NOT\_APPLIC|USER)**

returns the key in which CICS gives control to the program, which determines whether the program can modify CICS-key storage.

**CICS** CICS gives control to the program in CICS key. The program is loaded into a CICS dynamic storage area (DSA), above or below the 16MB line; that is, the CDSA or ECDSA, depending on its residency mode (RMODE) attribute as defined to the linkage-editor.

## **NOT\_APPLIC**

Not applicable. This is a mapset, partitionset, or a remote program.

**USER** CICS gives control to the program in user key. The program is loaded into a user DSA, above or below the 16MB line; that is, the UDSA or EUDSA, depending on its residency mode (RMODE) attribute as defined to the linkage-editor.

**EXECUTION\_SET(DPLSUBSET|FULLAPI|NOT\_APPLIC)**

returns a value indicating whether CICS links to and runs the program as if it were running in a remote CICS region.

**DPLSUBSET**

CICS links to and runs the program with the API restrictions of a remote DPL program. The program can use only a subset of the CICS API.

**FULLAPI**

CICS links to and runs the program without the API restrictions of a remote DPL program. The program can use the full CICS API.

**NOT\_APPLIC**

Not applicable. This is a mapset, partitionset, or a remote program. (The EXECUTIONSET option of DEFINE PROGRAM applies only to local program definitions. Its purpose is to test programs in a local CICS environment as if they were running as DPL programs.)

**HOLD\_STATUS(CICS\_LIFE|NOT\_APPLIC|TASK\_LIFE)**

returns a value indicating how long the program is to remain loaded.

**CICS\_LIFE**

The program remains loaded until CICS is shut down.

**NOT\_APPLIC**

Not applicable. The program is not loaded, or is remote.

**TASK\_LIFE**

The program remains loaded for the lifetime of the task.

**INSTALL\_TYPE(AUTO|CATALOG|GROUPLIST|MANUAL|RDO|SYSAUTO)**

returns the method that was used to install the PROGRAM resource definition.

**AUTO** Autoinstall.

**CATALOG**

The CICS global catalog, after a restart.

**GROUPLIST**

The CICS startup grouplist.

**MANUAL**

The program is a CICS internal module explicitly defined to the Program Manager by another CICS component.

**RDO** RDO commands.

**SYSAUTO**

System autoinstall (that is, autoinstalled by CICS without calling the autoinstall user program). The program may be a CICS internal module or, for example, a first phase PLTPI program.

**LANGUAGE\_DEDUCED(ASSEMBLER|C370|COBOL|COBOL2|LE370|NOT\_APPLIC|NOT\_DEDUCED|PLI)**

returns the language deduced by CICS for the program. COBOL is OS/VS COBOL, which cannot run under this CICS version, and COBOL2 is either Enterprise COBOL or VS COBOL II.

**LANGUAGE\_DEFINED(ASSEMBLER|C370|COBOL|LE370| NOT\_APPLIC|NOT\_DEFINED|PLI)**  
returns the programming language specified on the resource definition.

**LIBRARY(name)**

returns the 8-character name of the LIBRARY resource from which this program was loaded. This is blank if the program has not been loaded, or if the LPASTATUS is LPA (indicating that the program has been loaded from the LPA).

**LIBRARYDSN(data-area)**

displays the 44-character name of the data set from which the program was loaded. This is blank if the program has not been loaded, or if the LPASTATUS is LPA (indicating that the program has been loaded from the LPA).

- If the program was loaded from an installed LIBRARY, the LIBRARY and LIBRARYDSN names will be returned.
- If the program was loaded from a LIBRARY that has been disabled, the LIBRARY name will be returned but the LIBRARYDSN will be blank.
- If the program was loaded from a LIBRARY that has been discarded, both LIBRARY and LIBRARYDSN will be blank.

**LOAD\_POINT(name4)**

returns the program's load point address, as it would be returned by a Loader domain ACQUIRE\_PROGRAM call.

**LOAD\_STATUS(LOADABLE|NOT\_APPLIC|NOT\_LOADABLE|NOT\_LOADED)**

returns a value indicating whether or not the program can be loaded.

**LOADABLE**

The program is loadable.

**NOT\_APPLIC**

Not applicable. The program is remote.

**NOT\_LOADABLE**

CICS has tried to load the program and failed; the program is not in the library.

**NOT\_LOADED**

CICS has not yet tried to load the program.

**LOCATION(CDSA|ECDSA|ELPA|ERDSA|ESDSA|LPA|NONE|RDSA|SDSA)**

returns a value indicating where the most recently loaded copy of the program resides.

**CDSA** The CICS dynamic storage area

**ECDSA**

The extended CICS dynamic storage area

**ELPA** The extended link pack area

**ERDSA**

The extended readonly dynamic storage area

**ESDSA**

The extended shared dynamic storage area

**LPA** The link pack area

**NONE** The program has not been loaded.

**RDSA** The readonly dynamic storage area

**SDSA** The shared dynamic storage area



**MODULE\_TYPE(MAPSET|PARTITIONSET|PROGRAM)**

returns the kind of program resource.

**NEW\_PROGRAM\_TOKEN(name4)**

returns a token that can be used to identify the named program.

**name4**

The name of a location to receive a 4-byte token that identifies this program.

If PROGRAM\_NAME is specified on the request, NEW\_PROGRAM\_TOKEN is set to a program token that can be used on subsequent requests for the same program. If PROGRAM\_TOKEN is specified on the request, NEW\_PROGRAM\_TOKEN is set to the same value.

**PROGRAM\_ATTRIBUTE(RELOAD|RESIDENT|REUSABLE|TRANSIENT)**

returns the residency status of the program—that is, when its storage is released.

**RELOAD**

The program is not reusable, and therefore several copies may be loaded. A copy is removed from storage when a RELEASE\_PROGRAM call (for that copy) is issued.

**RESIDENT**

There is a single copy of the program that is not removed from storage unless deleted. RESIDENT programs must be at least quaireentrant. Any program of PROGRAM\_TYPE SHARED is RESIDENT by default.

**REUSABLE**

Similar to RESIDENT, except that a REUSABLE program that is not in use can be removed from storage by CICS, for storage optimization reasons.

**TRANSIENT**

Similar to RESIDENT, except that a TRANSIENT program is removed from storage as soon as its user count drops to zero.

**PROGRAM\_LENGTH(name4)**

returns the length of the program, in bytes, expressed in binary.

**PROGRAM\_NAME(name8 | string | 'string')**

specifies the name of the program to be queried.

**name8**

The name of a location containing an 8-byte program name.

**string** A string of characters naming the program.

**'string'**

A string of characters in quotation marks. The string length is set to 8 by padding with blanks or truncating.

**PROGRAM\_TOKEN(name4)**

specifies a token identifying the program to be queried.

**name4**

The name of a location containing a 4-byte token obtained from a previous INQUIRE\_PROGRAM call.

**PROGRAM\_TYPE(NOT\_APPLIC|PRIVATE|SHARED|TYPE\_ANY)**

returns a value indicating where the next new copy of the program is to be loaded from.

**NOT\_APPLIC**

Not applicable. The program is remote.

**PRIVATE**

The program is to be loaded from the DFHRPL or dynamic LIBRARY concatenation.. A PRIVATE program need not be reentrant, and is given only limited protection against unauthorized overwriting. The degree of protection depends on the type of dynamic storage area into which the program is loaded (see the description of the PROGRAM\_TYPE option of the DEFINE\_PROGRAM call).

**SHARED**

The program is to be loaded from the link pack area (LPA). SHARED programs must be reentrant, and are protected.

The next time a NEWCOPY or PHASEIN is received, an LPA copy of the program is used if it is available. If no LPA version is available, the program is loaded from DFHRPL or dynamic LIBRARY concatenation.

**TYPE\_ANY**

Either the copy in DFHRPL or a dynamic LIBRARY concatenation, or the LPA copy of the program can be used, though preference is given to the LPA copy.

**PROGRAM\_USAGE(APPLICATION|NUCLEUS)**

returns a value indicating whether the program is used as a CICS nucleus program or as a user application program.

**PROGRAM\_USE\_COUNT(name4)**

returns the number of different users that have invoked the program.

**PROGRAM\_USER\_COUNT(name4)**

returns the current number of users of the program.

**REMOTE\_DEFINITION(LOCAL|REMOTE)**

returns a value indicating whether this program is a local or a remote resource. If it is a remote resource, CICS treats requests to link to the program as distributed program link (DPL) requests, and ships them to the remote region.

**REMOTE\_PROGID(name8)**

returns the name by which the program is known in the remote CICS region, if the program is a remote resource. If REMOTESYSTEM was specified on the PROGRAM definition, and REMOTENAME omitted, the remote name will be the same as the local name (that is, REMOTE\_PROGID will default to the value of PROGRAM\_NAME).

**REMOTE\_SYSID(name4)**

returns the name of the remote CICS region that owns the program, if the program is a remote resource.

**REMOTE\_TRANID(name4)**

returns the name of the transaction that the remote CICS attaches, and under which it runs the program, if the program is a remote resource.

**SPECIFIED\_AMODE(24|31|AMODE\_ANY|AMODE\_NOT\_SPECIFIED)**

returns the addressing mode specified on a DEFINE\_PROGRAM call.

**SPECIFIED\_RMODE(24|RMODE\_ANY|RMODE\_NOT\_SPECIFIED)**

returns the residency mode (that is, whether the program should be loaded above or below the 16MB line) specified on a DEFINE\_PROGRAM call.

## RESPONSE and REASON values for INQUIRE\_PROGRAM:

<i>RESPONSE</i>	<i>REASON</i>
OK	None
EXCEPTION	PROGRAM_NOT_DEFINED_TO_LD PROGRAM_NOT_DEFINED_TO_PG
DISASTER	ABEND LOCK_ERROR
INVALID	INVALID_PROGRAM_TOKEN
KERNERROR	None
PURGED	None

## The INQUIRE\_CURRENT\_PROGRAM call

INQUIRE\_CURRENT\_PROGRAM returns information about the attributes of the program that is currently running. If this call is issued from within a global user exit or task-related user exit, it returns the attributes of the global user exit program or task-related user exit program itself.

### INQUIRE\_CURRENT\_PROGRAM

```
DFHPGISX [CALL,]
  [CLEAR,]
  [IN,
  FUNCTION(INQUIRE_CURRENT_PROGRAM),]
  [IGNORE_EXITS(YES|NO),]
  [OUT,
  [AVAIL_STATUS(DISABLED|ENABLED),]
  [CEDF_STATUS(CEDF|NOCEDF|NOT_APPLIC),]
  [CURRENT_AMODE(24|31),]
  [CURRENT_CEDF_STATUS(CEDF|NOCEDF),]
  [CURRENT_ENTRY_POINT(name4),]
  [CURRENT_ENVIRONMENT(EXEC|GLUE|PLT|SYSTEM|TRUE|URM),]
  [CURRENT_EXECUTION_SET(DPLSUBSET|FULLAPI),]
  [CURRENT_LOAD_POINT(name4),]
  [CURRENT_PROGRAM_LENGTH(name4),]
  [CURRENT_PROGRAM_NAME(name8),]
  [DATA_LOCATION(ANY|BELOW|NOT_APPLIC),]
  [DYNAMIC_STATUS(DYNAMIC|NOT_DYNAMIC),]
  [EXECUTION_KEY(CICS|NOT_APPLIC|USER),]
  [EXECUTION_SET(DPLSUBSET|FULLAPI|NOT_APPLIC),]
  [HOLD_STATUS(CICS_LIFE|NOT_APPLIC|TASK_LIFE),]
  [IGNORE_EXITS(YES|NO),]
  [INSTALL_TYPE(AUTO|CATALOG|GROUPLIST|MANUAL|RDO|SYSAUTO),]
  [INVOKING_ENVIRONMENT(EXEC|GLUE|PLT|SYSTEM|TRUE|URM),]
  [INVOKING_PROGRAM_NAME(name8),]
  [LANGUAGE_DEDUCED(ASSEMBLER|C370|COBOL|
                    COBOL2|LE370|NOT_APPLIC|NOT_DEDUCED|PLI),]
  [LANGUAGE_DEFINED(ASSEMBLER|C370|COBOL|
                    LE370|NOT_APPLIC|NOT_DEFINED|PLI),]
  [LIBRARY(name8),]
  [LIBRARYDSN(name44),]
  [LOAD_STATUS(LOADABLE|NOT_APPLIC|NOT_LOADABLE|NOT_LOADED),]
  [MODULE_TYPE(MAPSET|PARTITIONSET|PROGRAM),]
  [NEW_PROGRAM_TOKEN(name4),]
  [REMOTE_DEFINITION(LOCAL|REMOTE),]
  [REMOTE_PROGID(name8),]
  [REMOTE_SYSID(name4),]
  [REMOTE_TRANID(name4),]
  [RETURN_PROGRAM_NAME(name8),]
  RESPONSE(name1 | *),
  REASON(name1 | *)]
```

This command is threadsafe.

**Note:** The options not described in the following list are identical to the equivalent options of the INQUIRE\_PROGRAM call.

**CURRENT\_AMODE(24|31)**

returns the addressing mode which the running program is currently using.

**CURRENT\_CEDF\_STATUS(CEDF|NOCEDF)**

returns the EDF status of the current instance of the program. The value returned is the same as for CEDF\_STATUS, which is the EDF status specified on the program definition. See the CEDF\_STATUS option of INQUIRE\_PROGRAM.

**CURRENT\_ENTRY\_POINT(name4)**

returns the entry point address of the current program.

**CURRENT\_ENVIRONMENT(EXEC|GLUE|PLT|SYSTEM|TRUE|URM)**

returns the environment in which the current program is running—that is, the type of program it is.

**EXEC** User application program

**GLUE** Global user exit program

**PLT** Program list table program

**SYSTEM**

CICS system code

**TRUE** Task-related user exit program

**URM** User-replaceable program

**CURRENT\_EXECUTION\_SET(DPLSUBSET|FULLAPI)**

returns the API execution set used by the current instance of the program. The value returned is the same as for EXECUTION\_SET (which is the API execution set specified on the program definition) *unless* this is the first program in a transaction, when the value may be different. This is because the DPLSUBSET attribute applies only to linked-to programs. It is ignored for the first program in a transaction, because this cannot be the target of a DPL call. Therefore, for the first program in a transaction, if EXECUTION\_SET returns DPLSUBSET, CURRENT\_EXECUTION\_SET nevertheless returns FULLAPI. See the EXECUTION\_SET option of INQUIRE\_PROGRAM.

**CURRENT\_LOAD\_POINT(name4)**

returns the load point address of the current program.

**CURRENT\_PROGRAM\_LENGTH(name4)**

returns the length of the current program, in bytes, expressed in binary.

**CURRENT\_PROGRAM\_NAME(name8)**

returns the name of the program that is currently running.

**IGNORE\_EXITS(YES|NO)**

specifies whether global user exit programs and task-related user exit programs are ignored when returning information about the program which invoked the current program and to which control will be returned. Your setting for this option affects the values returned by the INVOKING\_ENVIRONMENT, INVOKING\_PROGRAM\_NAME, and RETURN\_PROGRAM\_NAME options. If YES is specified, which is the default, global user exit programs and task-related user exit programs are ignored for these options. If NO is specified,

| where a global user exit program or task-related user exit program is involved,  
| the options return information about the exit program.

**INVOKING\_ENVIRONMENT (EXEC|GLUE|PLT|SYSTEM|TRUE|URM)**

| returns the environment from which the current program was invoked; that is,  
| the environment corresponding to the program named in  
| INVOKING\_PROGRAM\_NAME. The values are as described for  
| CURRENT\_ENVIRONMENT.

**INVOKING\_PROGRAM\_NAME (name8)**

| returns the name of the most recent program to invoke the current program. If  
| IGNORE\_EXITS(NO) is specified, this might be a global user exit program or  
| task-related user exit program, if one was involved. If IGNORE\_EXITS(YES) is  
| specified, which is the default, this is the most recent program that was not a  
| global user exit program or task-related user exit program.

**LIBRARY (name)**

returns the 8-character name of the LIBRARY resource from which this program  
was loaded. This is blank if the program has not been loaded, or if the  
LPASTATUS is LPA (indicating that the program has been loaded from the  
LPA). If the program was loaded from an installed LIBRARY, the LIBRARY and  
LIBRARYDSN names are returned.

**LIBRARYDSN (data-area)**

returns the 44-character name of the data set from which the program was  
loaded. This is blank if the program has not been loaded, or if the LPASTATUS  
is LPA (indicating that the program has been loaded from the LPA). If the  
program was loaded from an installed LIBRARY, the LIBRARY and  
LIBRARYDSN names are returned.

**RETURN\_PROGRAM\_NAME (name8)**

| returns the name of the program to which control will be returned. If  
| IGNORE\_EXITS(NO) is specified, this might be a global user exit program or  
| task-related user exit program. If IGNORE\_EXITS(YES) is specified, which is  
| the default, this is the program to which control will be returned after any  
| intermediate global user exit programs or task-related user exit programs have  
| completed.

**RESPONSE and REASON values for  
INQUIRE\_CURRENT\_PROGRAM:**

<i>RESPONSE</i>	<i>REASON</i>
OK	None
EXCEPTION	NO_CURRENT_PROGRAM
DISASTER	LOCK_ERROR
	ABEND
INVALID	None
KERNERROR	None
PURGED	None

## The SET\_PROGRAM call

SET\_PROGRAM allows you to set selected attributes in the definition of a specified program.

## SET\_PROGRAM

```
DFHPGISX [CALL,]
  [CLEAR,]
  [IN,
  FUNCTION(SET_PROGRAM),
  {PROGRAM_NAME(name8 | string | 'string')|
  PROGRAM_TOKEN(name4)},]
  [AVAIL_STATUS(DISABLED|ENABLED),]
  [CEDF_STATUS(CEDF|NOCEDF),]
  [EXECUTION_KEY(CICS|USER),]
  [EXECUTION_SET(DPLSUBSET|FULLAPI),]
  [PROGRAM_ATTRIBUTE(RELOAD|RESIDENT|REUSABLE|TRANSIENT),]
  [PROGRAM_TYPE(PRIVATE|SHARED|TYPE_ANY),]
  [PROGRAM_USAGE(APPLICATION|NUCLEUS),]
  [REQUIRED_AMODE(24|31|AMODE_ANY),]
  [REQUIRED_RMODE(24|RMODE_ANY),]
  [OUT,
  RESPONSE(name1 | *),
  REASON(name1 | *)]
```

This command is threadsafe.

### AVAIL\_STATUS(DISABLED|ENABLED)

specifies whether the program can be used—that is, whether or not it is enabled.

### CEDF\_STATUS(CEDF|NOCEDF)

specifies whether, when the program is running under the control of the CICS execution diagnostic facility (EDF), EDF diagnostic screens are displayed.

### EXECUTION\_KEY(CICS|USER)

specifies the key in which CICS is to give control to the program. The key determines whether the program can modify CICS-key storage.

**CICS** CICS gives control to the program in CICS key. The program is loaded into a CICS dynamic storage area (DSA), above or below the 16MB line; that is, the CDSA or ECDSA, depending on its residency mode (RMODE) attribute as defined to the linkage-editor.

**USER** CICS gives control to the program in user key. The program is loaded into a user DSA, above or below the 16MB line; that is, the UDSA or EUDSA, depending on its residency mode (RMODE) attribute as defined to the linkage-editor.

**Note:** If the program has been link-edited as reentrant with AMODE(31),RMODE(ANY), the EXECUTION\_KEY option is ignored, and it is loaded into the extended readonly DSA (ERDSA). For details of the type of storage allocated for the ERDSA, see the RENTPGM system initialization parameter.

### EXECUTION\_SET(DPLSUBSET|FULLAPI)

specifies whether CICS is to link to and run the program as if it were running in a remote CICS region.

**Note:** EXECUTION\_SET applies only to local program definitions. Its purpose is to test programs in a local CICS environment as if they were running as DPL programs.

### DPLSUBSET

CICS links to and runs the program with the API restrictions of a remote DPL program. The program can use only a subset of the CICS API.

## **FULLAPI**

CICS links to and runs the program without the API restrictions of a remote DPL program. The program can use the full CICS API.

## **PROGRAM\_ATTRIBUTE(RELOAD|RESIDENT|REUSABLE|TRANSIENT)**

specifies the residency status of the program—that is, when its storage is to be released.

### **RELOAD**

The program is not reusable, and therefore several copies may be loaded. A copy is removed from storage when a `RELEASE_PROGRAM` call (for that copy) is issued.

### **RESIDENT**

At any one time there will be no more than a single copy of the program in storage, and this will not be removed unless deleted. `RESIDENT` programs must be at least quasireentrant. Any program of `PROGRAM_TYPE SHARED` is `RESIDENT` by default.

### **REUSABLE**

Similar to `RESIDENT`, except that a `REUSABLE` program that is not in use can be removed from storage by CICS, for storage optimization reasons.

### **TRANSIENT**

Similar to `RESIDENT`, except that a `TRANSIENT` program is removed from storage as soon as its user count drops to zero.

## **PROGRAM\_NAME(name8 | string | 'string')**

specifies the name of the program whose attributes are to be changed.

### **name8**

The name of a location containing an 8-byte program name.

**string** A string of characters naming the program.

### **'string'**

A string of characters in quotation marks. The string length is set to 8 by padding with blanks or truncating.

## **PROGRAM\_TOKEN(name4)**

specifies a token identifying the program.

### **name4**

The name of a location containing a 4-byte token obtained from a previous `INQUIRE_PROGRAM`, `INQUIRE_CURRENT_PROGRAM`, `START_BROWSE_PROGRAM`, or `GET_NEXT_PROGRAM` call.

## **PROGRAM\_TYPE(PRIVATE|SHARED|TYPE\_ANY)**

specifies where the program is to be loaded from.

### **PRIVATE**

The program is in the DFHRPL or dynamic LIBRARY concatenation. A `PRIVATE` program need not be reentrant, and is given only limited protection against unauthorized overwriting. The degree of protection depends on the type of dynamic storage area into which the program is loaded (see the description of the `PROGRAM_TYPE` option of the `DEFINE_PROGRAM` call).

### **SHARED**

The program is located in the link pack area (LPA), is reentrant, and is protected.

### TYPE\_ANY

Either the copy in the DFHRPL or a dynamic LIBRARY concatenation, or the LPA copy of the program can be used, though preference is given to the LPA copy.

### PROGRAM\_USAGE(APPLICATION|NUCLEUS)

specifies whether the program is used as a CICS nucleus program or as a user application program.

### REQUIRED\_AMODE(24|31|AMODE\_ANY)

specifies the addressing mode of the program. If, during subsequent processing, no copy of the program that meets the defined addressing requirement can be found, an exception occurs.

#### Note:

1. AMODE\_ANY and 31 have identical meanings for this function.
2. You cannot use this option to override the link-edited addressing mode of the program.

### REQUIRED\_RMODE(24|AMODE\_ANY)

specifies the residency mode of the program (that is, whether it is to be loaded above or below the 16MB line). If, during subsequent processing, no copy of the program that meets the defined residency requirement can be found, an exception occurs.

**Note:** You cannot use this option to override the link-edited residency mode of the program.

## RESPONSE and REASON values for SET\_PROGRAM:

<i>RESPONSE</i>	<i>REASON</i>
OK	None
EXCEPTION	CEDF_STATUS_NOT_FOR_MAPSET CEDF_STATUS_NOT_FOR_PTNSSET CEDF_STATUS_NOT_FOR_REMOTE EXEC_KEY_NOT_FOR_MAPSET EXEC_KEY_NOT_FOR_PTNSSET EXEC_KEY_NOT_FOR_REMOTE EXEC_SET_NOT_FOR_MAPSET EXEC_SET_NOT_FOR_PTNSSET EXEC_SET_NOT_FOR_REMOTE PROGRAM_NOT_DEFINED_TO_LD PROGRAM_NOT_DEFINED_TO_PG
DISASTER	ABEND CATALOG_ERROR CATALOG_NOT_OPERATIONAL LOCK_ERROR
INVALID	INVALID_MODE_COMBINATION INVALID_PROGRAM_NAME INVALID_PROGRAM_TOKEN INVALID_TYPE_ATTRIB_COMBIN
KERNERROR	None
PURGED	None



## The START\_BROWSE\_PROGRAM call

START\_BROWSE\_PROGRAM returns a token that enables you to begin browsing through program definitions, optionally starting at the definition of a specified program.

### START\_BROWSE\_PROGRAM

```
DFHPGISX [CALL,]
          [CLEAR,]
          [IN,
           FUNCTION(START_BROWSE_PROGRAM),
           [PROGRAM_NAME(name8 | string | 'string'),]]
          [OUT,
           BROWSE_TOKEN(name4)
           RESPONSE(name1 | *),
           REASON(name1 | *)]
```

This command is threadsafe.

#### **BROWSE\_TOKEN(name4)**

returns a token to be used on a GET\_NEXT\_PROGRAM call, to initiate a sequential browse of program definitions.

#### **name4**

The name of a location to receive a 4-byte token.

#### **PROGRAM\_NAME(name8 | string | 'string')**

specifies the name of the program whose definition you want to look at first.

The browsing sequence is alphabetical. If there is no program with the specified name, CICS returns a token for the next definition in the alphabetic sequence. If you do not specify a program, CICS returns a token for the first definition.

#### **name8**

The name of a location containing an 8-byte program name.

**string** A string of characters naming the program.

#### **'string'**

A string of characters in quotation marks. The string length is set to 8 by padding with blanks or truncating.

### **RESPONSE and REASON values for START\_BROWSE\_PROGRAM:**

<i>RESPONSE</i>	<i>REASON</i>
OK	None
EXCEPTION	None
DISASTER	ABEND
	INVALID_DIRECTORY
	LOCK_ERROR
INVALID	None
KERNERROR	None
PURGED	None

## The GET\_NEXT\_PROGRAM call

GET\_NEXT\_PROGRAM allows you to inquire on the next program definition during a browse sequence initiated by START\_BROWSE\_PROGRAM. The browsing sequence is alphabetical. The end of the alphabetic list of definitions is indicated by an 'END\_LIST' exception response.

### GET\_NEXT\_PROGRAM

```
DFHPGISX [CALL,]
  [CLEAR,]
  [IN,
  FUNCTION(GET_NEXT_PROGRAM),
  BROWSE_TOKEN(name4),]
  [OUT,
  PROGRAM_NAME(name8),
  [ACCESS(CICS|NONE|READ_ONLY|USER),]
  [AVAIL_STATUS(DISABLED|ENABLED),]
  [CEDF_STATUS(CEDF|NOCEDF|NOT_APPLIC),]
  [DATA_LOCATION(ANY|BELOW|NOT_APPLIC),]
  [ENTRY_POINT(name4),]
  [EXECUTION_KEY(CICS|NOT_APPLIC|USER),]
  [EXECUTION_SET(DPLSUBSET|FULLAPI|NOT_APPLIC),]
  [HOLD_STATUS(CICS_LIFE|NOT_APPLIC|TASK_LIFE),]
  [INSTALL_TYPE(AUTO|CATALOG|GROUPLIST|MANUAL|RDO|SYSAUTO),]
  [LANGUAGE_DEDUCED(ASSEMBLER|C370|COBOL|
                    COBOL2|LE370|NOT_APPLIC|NOT_DEDUCED|PLI),]
  [LANGUAGE_DEFINED(ASSEMBLER|C370|COBOL|
                    LE370|NOT_APPLIC|NOT_DEFINED|PLI),]
  [LOAD_POINT(name4),]
  [LOAD_STATUS(LOADABLE|NOT_APPLIC|NOT_LOADABLE|NOT_LOADED),]
  [LOCATION(CDSA|ECDSA|ELPA|ERDSA|ESDSA|LPA|NONE|RDSA|SDSA),]
  [MODULE_TYPE(MAPSET|PARTITIONSET|PROGRAM),]
  [NEW_PROGRAM_TOKEN(name4),]
  [PROGRAM_ATTRIBUTE(RELOAD|RESIDENT|REUSABLE|TRANSIENT),]
  [PROGRAM_LENGTH(name4),]
  [PROGRAM_TYPE(NOT_APPLIC|PRIVATE|SHARED|TYPE_ANY),]
  [PROGRAM_USAGE(APPLICATION|NUCLEUS),]
  [PROGRAM_USE_COUNT(name4),]
  [PROGRAM_USER_COUNT(name4),]
  [REMOTE_DEFINITION(LOCAL|REMOTE),]
  [REMOTE_PROGID(name8),]
  [REMOTE_SYSID(name4),]
  [REMOTE_TRANID(name4),]
  [SPECIFIED_AMODE(24|31|AMODE_ANY|AMODE_NOT_SPECIFIED),]
  [SPECIFIED_RMODE(24|RMODE_ANY|RMODE_NOT_SPECIFIED),]
  RESPONSE(name1 | *),
  REASON(name1 | *)]
```

This command is threadsafe.

**Note:** The options not described in the following list are identical to the equivalent options of the INQUIRE\_PROGRAM call.

#### BROWSE\_TOKEN(name4)

specifies a token identifying the definition to be browsed. This can be either the token returned in the NEW\_PROGRAM\_TOKEN field of the last GET\_NEXT\_PROGRAM call, or that in the BROWSE\_TOKEN field of the START\_BROWSE\_PROGRAM call (this token is updated after every GET\_PROGRAM call).

#### name4

The name of a location containing a 4-byte token.

**NEW\_PROGRAM\_TOKEN(name4)**

returns a token that identifies the next definition in the browse sequence. You can use it in the BROWSE\_TOKEN field of your next GET\_NEXT\_PROGRAM call (or END\_BROWSE\_PROGRAM call, if you want to end the sequence). You can also use it in the PROGRAM\_TOKEN field of INQUIRE\_PROGRAM and SET\_PROGRAM calls.

**name4**

The name of a location to receive a 4-byte token that identifies the next program definition.

**RESPONSE and REASON values for GET\_NEXT\_PROGRAM:**

<i>RESPONSE</i>	<i>REASON</i>
OK	None
EXCEPTION	END_LIST
	INVALID_BROWSE_TOKEN
	PROGRAM_NOT_DEFINED_TO_LD
DISASTER	ABEND
	LOCK_ERROR
INVALID	None
KERNERROR	None
PURGED	None

**The END\_BROWSE\_PROGRAM call**

END\_BROWSE\_PROGRAM allows you to end a browse of program definitions initiated by START\_BROWSE\_PROGRAM.

**END\_BROWSE\_PROGRAM**

```
DFHPGISX [CALL,]
          [CLEAR,]
          [IN,
          FUNCTION(END_BROWSE_PROGRAM),
          BROWSE_TOKEN(name4),]
          [OUT,
          RESPONSE(name1 | *),
          REASON(name1 | *)]
```

This command is threadsafe.

**BROWSE\_TOKEN(name4)**

specifies either the token returned in the NEW\_PROGRAM\_TOKEN field of the last GET\_NEXT\_PROGRAM call, or that in the BROWSE\_TOKEN field of the START\_BROWSE\_PROGRAM call (this token is updated after every GET\_NEXT\_PROGRAM call).

**RESPONSE and REASON values for END\_BROWSE\_PROGRAM:**

<i>RESPONSE</i>	<i>REASON</i>
OK	None
EXCEPTION	INVALID_BROWSE_TOKEN
DISASTER	ABEND
	LOCK_ERROR
INVALID	None
KERNERROR	None
PURGED	None

## The INQUIRE\_AUTOINSTALL call

INQUIRE\_AUTOINSTALL returns information about the current settings of the autoinstall function for programs, mapsets, and partitionsets.

### INQUIRE\_AUTOINSTALL

```
DFHPGAQX [CALL,]  
  [CLEAR,]  
  [IN,  
  FUNCTION(INQUIRE_AUTOINSTALL),]  
  [OUT,  
  [AUTOINSTALL_CATALOG (ALL|MODIFY|NONE),]  
  [AUTOINSTALL_EXIT_NAME(name8),]  
  [AUTOINSTALL_STATE (ACTIVE|INACTIVE),]  
  RESPONSE(name1 | *),  
  REASON(name1 | *)]
```

This command is threadsafe.

#### AUTOINSTALL\_CATALOG(ALL|MODIFY|NONE)

returns the catalog status for autoinstalled program definitions.

**ALL** All autoinstalled program, map, and partitionset definitions are cataloged.

#### MODIFY

Autoinstalled program, map, and partitionset definitions are recorded on the CICS global catalog only if they are modified by a SET PROGRAM command after being autoinstalled.

**NONE** No autoinstalled program, map, or partitionset definitions are cataloged.

#### AUTOINSTALL\_EXIT\_NAME(name8)

returns the name of the user-replaceable autoinstall control program for programs, mapsets, and partitionsets.

#### AUTOINSTALL\_STATE(ACTIVE|INACTIVE)

returns the status of the program autoinstall function.

#### ACTIVE

Autoinstall is enabled for programs, mapsets, and partitionsets.

#### INACTIVE

Autoinstall is not enabled for programs, mapsets, and partitionsets.

#### RESPONSE and REASON values for INQUIRE\_AUTOINSTALL:

<i>RESPONSE</i>	<i>REASON</i>
OK	None
EXCEPTION	None
DISASTER	None
INVALID	INVALID_FUNCTION
KERNERROR	None
PURGED	None

## The SET\_AUTOINSTALL call

SET\_AUTOINSTALL enables you to change the settings of the autoinstall function for programs, mapsets, and partitionsets.

## SET\_AUTOINSTALL

```
DFHPGAQX [CALL,]
          [CLEAR,]
          [IN,
           FUNCTION(SET_AUTOINSTALL),
           [AUTOINSTALL_CATALOG (ALL|MODIFY|NONE),]
           [AUTOINSTALL_EXIT_NAME(name8),]
           [AUTOINSTALL_STATE (ACTIVE|INACTIVE),]
           [LANGUAGES_AVAILABLE(NO|YES),]]
          [OUT,
           RESPONSE(name1 | *),
           REASON(name1 | *)]
```

This command is threadsafe.

### AUTOINSTALL\_CATALOG(ALL|MODIFY|NONE)

specifies the catalog status for autoinstalled program definitions.

**ALL** All autoinstalled program, map, and partitionset definitions are to be cataloged.

#### MODIFY

Autoinstalled program, map, and partitionset definitions are to be recorded on the CICS global catalog only if they are modified by a SET PROGRAM command after being autoinstalled.

**NONE** No autoinstalled program, map, or partitionset definitions are to be cataloged.

### AUTOINSTALL\_EXIT\_NAME(name8)

specifies the name of the user-replaceable autoinstall control program for programs, mapsets, and partitionsets.

### AUTOINSTALL\_STATE(ACTIVE|INACTIVE)

specifies the status of the program autoinstall function.

#### ACTIVE

Enable autoinstall for programs, mapsets, and partitionsets.

#### INACTIVE

Disable autoinstall for programs, mapsets, and partitionsets.

### LANGUAGES\_AVAILABLE(NO|YES)

specifies whether the autoinstall control program can be called. It can only be called after language establishment.

**NO** The control program cannot be called.

**YES** The control program can be called.

## RESPONSE and REASON values for SET\_AUTOINSTALL:

<i>RESPONSE</i>	<i>REASON</i>
OK	None
EXCEPTION	None
DISASTER	None
INVALID	INVALID_FUNCTION
KERNERROR	None
PURGED	None

---

## State data access XPI functions

The state data access functions allow you to inquire on and set certain system data in the AP domain.

### The INQ\_APPLICATION\_DATA call

The INQ\_APPLICATION\_DATA call enables you to inquire on application system data in the AP domain.

#### INQ\_APPLICATION\_DATA

```
DFHAPIQX [CALL,]
  [CLEAR,]
  [IN,
  FUNCTION(INQ_APPLICATION_DATA),]
  [OUT,
  [ACEE(name4 | (Rn) | * ),]      [DSA(name4 | (Rn) | * ),]
  [EIB(name4 | (Rn) | * ),]
  [RSA(name4 | (Rn) | * ),]
  [SYSEIB(name4 | (Rn) | * ),]
  [TCTUA(name4 | (Rn) | * ),]
  [TCTUASIZE(name4 | * ),]
  [TWA(name4 | (Rn) | * ),]
  [TWASIZE(name4 | (Rn) | * ),]
  RESPONSE (name1 | * ),
  REASON (name1 | * )]
```

This command is threadsafe.

#### ACEE(name4 | (Rn) | \* )

returns the address of the access control environment element (ACEE).

##### name4

The name of a fullword area that is to receive the address of the ACEE.

**(Rn)** A register that is to receive the ACEE address.

\* The parameter list itself, in name APIQ\_ACEE, is used to hold the address.

#### DSA(name4 | (Rn) | \* )

returns the head of the chain of dynamic storage used by application programs to make them reentrant (for example, for assembler programs, the DFHEISTG storage).

##### name4

The name of a 4-byte area that is to receive the address of the head of the dynamic storage chain.

**(Rn)** A register that is to receive the DSA address.

\* The parameter list itself, in name APIQ\_DSA, is used to hold the address.

#### EIB(name4 | (Rn) | \* )

returns the address of the EXEC interface block (EIB) for the current task.

##### name4

The name of a fullword area that is to receive the address of the EIB.

**(Rn)** A register that is to receive the address of the EIB.

- \* The parameter list itself, in name APIQ\_EIB, is used to hold the address.

**RSA**(name4 | (Rn) | \*)

returns the address of the register save area for the current task.

**name4**

The name of a fullword area that is to receive the address of the register save area.

**(Rn)** A register that is to receive the address of the register save area.

- \* The parameter list itself, name APIQ\_RSA, is used to hold the address.

**SYSEIB**(name4 | (Rn) | \*)

returns the address of the system EXEC interface block of the current task.

**name4**

The name of a fullword area that is to receive the address of the system EXEC interface block.

**(Rn)** A register that is to receive the address of the system EXEC interface block.

- \* The parameter list itself, name APIQ\_SYSEIB, is used to hold the address.

**TCTUA**(name4 | (Rn) | \*)

returns the address of the terminal control table user area (TCTUA) for the current task.

**name4**

The name of a fullword area that is to receive the address of the TCTUA.

**(Rn)** A register that is to receive the address of the TCTUA.

- \* The parameter list itself, name APIQ\_TCTUA, is used to hold the address.

**TCTUASIZE**(name4 | (Rn) | \*)

returns the length in bytes of the TCTUA for the current task.

**name4**

The name of a 4-byte area that is to receive the length in bytes of the TCTUA.

**(Rn)** A register that is to receive the length of the TCTUA.

- \* The parameter list itself, name APIQ\_TCTUASIZE, is used to hold the length of the TCTUA.

**TWA**(name4 | (Rn) | \*)

returns the address of the transaction work area.

**name4**

The name of a fullword area that is to receive the address of the TWA.

**(Rn)** A register that is to receive the address of the TWA.

- \* The parameter list itself, name APIQ\_TWA, is used to hold the address of the TWA.

**TWASIZE**(name4 | (Rn) | \*)

returns the length, in bytes, of the transaction work area (TWA).

**name4**

The name of a 4-byte area that is to receive the length, in bytes, of the TWA.

**(Rn)** A register that is to receive the length of the TWA.

\* The parameter list itself, name APIQ\_TWASIZE, is used to hold the length of the TWA.

**RESPONSE and REASON values for INQ\_APPLICATION\_DATA:**

<i>RESPONSE</i>	<i>REASON</i>
OK	None
EXCEPTION	DPL_PROGRAM
	NO_TRANSACTION_ENVIRONMENT
	TRANSACTION_DOMAIN_ERROR
DISASTER	ABEND
	LOOP
	INQ_FAILED
INVALID	INVALID_FUNCTION
KERNERROR	None
PURGED	None

**The INQUIRE\_SYSTEM call**

The INQUIRE\_SYSTEM call gives you access to CICS system data in the AP domain.

**INQUIRE\_SYSTEM**

```
DFHSAIQX [CALL,]
  [CLEAR,]
  [IN,
  FUNCTION(INQUIRE_SYSTEM),
  [GMMTEXT(name4),]]
  [OUT,
  [CICSREL(name4 | *),]
  [CICSSTATUS(ACTIVE | FINALQUIESCE |
  FIRSTQUIESCE | INITIALIZING),]
  [CICSSYS(name1 | *),]
  [CICTSLEVEL(name6 | *),]
  [CWA(name4 | (Rn) | *),]
  [CWALENGTH(name2 | *),]
  [DATE(name4|*),]
  [DTRPRGRM(name8 | *),]
  [GMMLENGTH(name2 | *),]
  [GMMTRANID(name4 | *),]
  [INITSTATUS(FIRSTINIT | INITCOMPLETE | SECONDINIT |
  THIRDINIT),]
  [JOBNAME(name8 | *),]
  [OPREL(name2 | *),]
  [OPSYS(name1 | *),]
  [OSLEVEL(name4 | *),]
  [PLTPI(name2 | *),]
  [SDTRAN(name4 | *),]
  [SECURITYMGR(EXTSECURITY | NOSECURITY),]
  [SHUTSTATUS(CONTROLSHUT | NOTSHUTDOWN | SHUTDOWN),]
  [STARTUP(COLDSTART | EMERGENCY | WARMSTART),]
  [STARTUPDATE(name4 | *),]
  [TERMURM(name8 | *),]
```



```
[TIMEOFDAY(name4 | *),]  
[XRFSTATUS(NOXR | PRIMARY | TAKEOVER),]  
RESPONSE (name1 | * ),  
REASON (name1 | * )]
```

This command is threadsafe.

**CICSREL(name4 | \*)**

returns the level number of the CICS code under which the CICS region is running.

**name4**

The name of a 4-byte location that is to receive the level number characters as hexadecimal values.

**CICSSTATUS(ACTIVE|FINALQUIESE|FIRSTQUIESCE|INITIALIZING)**

returns the status of the CICS region.

**ACTIVE**

The CICS region is active and ready to receive work.

**FINALQUIESCE**

The CICS region is shutting down, and is in the final stage of quiescing.

**FIRSTQUIESCE**

The CICS region is shutting down, and is in the first stage of quiescing.

**INITIALIZING**

The CICS region is initializing.

**CICSSYS(name1 | \*)**

returns the operating system for which the running CICS has been built.

**name1**

The name of a 1-byte area that is to receive the hexadecimal character of the operating system. A value of "X" represents MVS/ESA.

**CICSTSLEVEL(name6 | \*)**

returns the release of CICS Transaction Server under which CICS is running.

**name6**

The name of a 6-byte area that is to receive the release characters as hexadecimal values.

**CWA(name4 | (Rn) | \*)**

returns the address of the common work area.

**name4**

The name of a 4-byte field that is to receive the address of the CWA.

**(Rn)** A register to receive the address of the CWA.

**CWALENGTH(name2 | \*)**

returns the length in bytes of the CWA.

**name2**

The name of a 2-byte field that is to receive the length of the CWA.

**DATE(name4 | \*)**

returns today's date in packed-decimal form—4-bytes **0Cyydds**, where:

- **C** is a century indicator. (0=1900, 1=2000, 2=2100, and so on.)
- **yy**=years.
- **ddd**=days.
- **s** is the sign.

**name4**

The name of a 4-byte location that is to receive the date.

**DTRPRGRM(name8 | \*)**

returns the name of the dynamic routing program.

**name8**

The name of an 8-byte area that is to receive the name of the dynamic routing program.

**GMMLENGTH(name2 | \*)**

returns the length in bytes of the “good morning” message.

**name2**

The name of a 2-byte area that is to receive the length of the good morning message.

**GMMTEXT(name4)**

specifies the address of an area of storage, at least 244 bytes in length and owned by the caller, into which CICS is to return the good morning message.

**name4**

The address of an area of storage that is to receive the good morning message.

**Note:** The GMMTEXT parameter must follow the IN statement as an input parameter.

**GMMTRANID(name4 | \*)**

returns the transaction identifier of the CICS good morning transaction.

**name4**

The name of a 4-byte area that is to receive the CICS good morning transaction id.

**INITSTATUS(FIRSTINIT|INITCOMPLETE|SECONDINIT|THIRDINIT)**

returns a value indicating the stage reached during CICS initialization.

**FIRSTINIT**

The first stage of CICS initialization.

**INITCOMPLETE**

CICS initialization is complete.

**SECONDINIT**

The second stage of CICS initialization. This stage corresponds to the period when first phase PLTPI programs are run; that is those programs in a PLT that are defined **before** the DFHDELIM statement.

**THIRDINIT**

The third stage of CICS initialization. This stage corresponds to the period when second phase PLTPI programs are run; that is those programs in a PLT that are defined **after** the DFHDELIM statement.

**JOBNAME(name8 | \*)**

returns the 8-character MVS job name under which the CICS region is running.

**name8**

The name of a 8-byte area that is to receive the MVS job name.

**OPREL(name2 | \*)**

returns the last 2 digits of the level number of the MVS element of OS/390, under which the CICS region is running.

**name2**

The name of a 2-byte area that is to receive, as a half-word binary value, the level number of the MVS element of OS/390. For example, OS/390 Release 3 MVS is represented by 03.

**Note:** This field is supported for compatibility purposes only. The information is derived from the last two numbers held in the MVS CVTPRODN field. For example, CVTPRODN holds SP5.2.2 for MVS/ESA SP Version 5 Release 2.2 (in which case OPREL returns 22), and SP6.0.3 for OS/390 Release 3. You are recommended to use the OSLEVEL field for the full version and release number of the OS/390 product.

**OPSYS(name1 | \*)**

returns the type of operating system on which the CICS regions is running.

**name1**

The name of a 1-byte area that is to receive the hexadecimal character of the operating system on which CICS is running. A value of "X" represents MVS/ESA.

**OSLEVEL(name4 | \*)**

is the version, release, and modification level of the OS/390 product on which CICS is running.

**name1**

The name of a 4-byte area that is to receive the version and release number of OS/390 on which CICS is running. A value of "0240" represents OS/390 Release 4.

**PLTPI(name2 | \*)**

returns the suffix that identifies the program list table (PLT) containing the list of programs to be run during CICS initialization—the program list table post initialization (PLTPI) list.

**name2**

The name of a 2-byte area that is to receive the suffix.

**SDTRAN(name4 | \*)**

returns the name of the "shutdown assist" transaction to be run at the beginning of normal or immediate shutdown. The shutdown assist transaction is described on page "The shutdown assist utility program, DFHCESD" on page 429.

**name4**

The name of a 4-byte area to receive the name.

**SECURITYMGR(EXTSECURITY|NOSECURITY)**

returns a value indicating whether security is active.

**EXTSECURITY**

CICS is using an external security manager (for example, RACF).

**NOSECURITY**

Security is not in use in the CICS region—SEC=NO is specified as a system initialization parameter.

**SHUTSTATUS(CONTROLSHUT|NOTSHUTDOWN|SHUTDOWN)**

returns the shutdown status of the CICS region.

**CONTROLSHUT**

CICS is performing a controlled shutdown; that is, a normal shutdown with a warm keypoint.

**NOTSHUTDOWN**

CICS is not in shutdown mode.

**SHUTDOWN**

CICS is performing an immediate shutdown.

**STARTUP(COLDSTART|EMERGENCY|WARMSTART)**

returns the type of startup the CICS region performed.

**COLDSTART**

CICS performed a cold start, either because this was explicitly specified on the system initialization parameter, or because CICS forced a cold start because of the state of the global catalog.

**EMERGENCY**

CICS performed an emergency restart because the previous run did not shut down normally with a warm keypoint.

**WARMSTART**

CICS performed a warm restart following the normal shutdown of the previous run.

**STARTUPDATE(name4 | \*)**

returns the start-up-date of this CICS region, in packed decimal form (4-bytes **00yydddc** where **yy**=years, **ddd**=days, **c** is the sign).

**name4**

The name of a 4-byte location that is to receive the startup date of this CICS system.

**TERMURM(name8 | \*)**

returns the name of the autoinstall user program for terminals.

**name8**

The name of an 8-byte area that is to receive the name of the autoinstall user program for terminals.

**TIMEOFDAY(name4 | \*)**

returns the current time-of-day in packed decimal form (4-bytes **hhmmsstc** where **hh**=hours, **mm**=minutes, **ss**=seconds, **t**=tenths of a second, and **c** is the sign).

**name4**

The name of a 4-byte location that is to receive the time.

**XRFSTATUS(NOXRF|PRIMARY|TAKEOVER)**

returns the XRF status of the CICS region.

**NOXRF**

CICS was started with the system initialization parameter XRF=NO specified. XRF is not active.

**PRIMARY**

The CICS region was started as an active CICS in an XRF environment.

**TAKEOVER**

The CICS region was started as an alternate CICS, with the START=STANDBY system initialization parameter.

**RESPONSE and REASON values for INQUIRE\_SYSTEM**

*RESPONSE*  
OK

*REASON*  
None

<i>RESPONSE</i>	<i>REASON</i>
INVALID	INVALID_FUNCTION
EXCEPTION	LENGTH_ERROR
	UNKNOWN_DATA
DISASTER	INQ_FAILED
PURGED	None

## The SET\_SYSTEM call

The SET\_SYSTEM call allows you to set CICS system data values in the AP domain.

### SET\_SYSTEM

```
DFHSAIQX [CALL,]
  [CLEAR,]
  [IN,
  FUNCTION(SET_SYSTEM),
  [DTRPRGRM(name8 | string | 'string'),]
  [GMMLNGTH(name2 | (Rn) | expression),]
  [GMMTEXT(name8 | (Rn)),]]
  [OUT,
  RESPONSE (name1 | * ),
  REASON (name1 | * )]
```

This command is threadsafe.

#### DTRPRGRM(name8 | string | 'string')

specifies the name of the dynamic routing program.

##### name8

The name of an 8-byte area that contains the name of the dynamic routing program.

**string** A string of character, without intervening blanks, that defines the name of the dynamic routing program being set.

##### 'string'

A string of character without intervening blanks. If you want to document a name (label) in your program, use this form.

#### GMMLNGTH(name2 | (Rn))

specifies the length of the new “good morning” message supplied by the GMMTEXT parameter.

##### name2

The name of a 2-byte area that contains, as a half-word binary value, the length of the new good morning message.

**(Rn)** A register that contains the length of the new good morning message.

#### GMMTEXT(name4 | (Rn))

specifies the new good morning message.

##### name4

The name of a 4-byte location that contains the address of a storage area (up to a maximum of 246 bytes long) that contains the good morning message.

**(Rn)** A register that contains the address of a storage area (up to a maximum of 246 bytes long) that contains the good morning message.

## RESPONSE and REASON values for SET\_SYSTEM:

<i>RESPONSE</i>	<i>REASON</i>
OK	None
INVALID EXCEPTION	INVALID_FUNCTION AKP_SIZE_ERROR NO_KEYPOINT
DISASTER PURGED	SET_FAILED None

---

## Storage control XPI functions

There are seven XPI storage control functions. These are the DFHSMCX macro calls GETMAIN, FREEMAIN, INQUIRE\_ELEMENT\_LENGTH, and INQUIRE\_TASK\_STORAGE, and the DFHMSRX calls INQUIRE\_ACCESS, INQUIRE\_SHORT\_ON\_STORAGE, and SWITCH\_SUBSPACE.

**DFHSMCX calls cannot be used** in any exit program invoked from any global user exit point in the:

- Dispatcher domain
- Dump domain
- Monitor domain
- Statistics domain
- Transient data program.

## The GETMAIN call

GETMAIN acquires an element of storage for use by your exit program. You can ask for a particular CLASS of storage, and you can request that it be initialized to a single-byte value.

Storage in the following classes, acquired by a GETMAIN call, is released by CICS when the TCA being used at the time of the acquisition terminates:

- CICS
- CICS24
- USER
- USER24.

In contrast, storage in the following classes is **not** released automatically at task-end: you should use the FREEMAIN call to release it:

- SHARED\_CICS
- SHARED\_CICS24
- SHARED\_USER
- SHARED\_USER24
- TERMINAL.

In addition, some user exits may be invoked from system tasks, and in these circumstances storage is not released until the next CICS shutdown. Therefore you should use FREEMAIN to release all storage areas acquired by GETMAIN as soon as you have finished using them.

## GETMAIN

```
DFHSMCX [CALL,]  
  [CLEAR,]  
  [IN,  
  FUNCTION(GETMAIN),  
  GET_LENGTH(name4 | (Rn) | expression),  
  STORAGE_CLASS(CICS|CICS24|SHARED_CICS|SHARED_CICS24|  
                SHARED_USER|SHARED_USER24|USER|USER24|TERMINAL),  
  SUSPEND(NO|YES),  
  [INITIAL_IMAGE(name1 | literalconst),]  
  [TCTTE_ADDRESS(name4 | (Ra)),]  
  [OUT,  
  ADDRESS(name4 | (Rn) | *),  
  RESPONSE(name1 | *),  
  REASON(name1 | *)]
```

This command is threadsafe.

### ADDRESS(name4 | (Rn) | \*)

returns the address of the storage obtained by the call.

#### name4

The name of a fullword where the obtained storage address is saved

**(Rn)** A register that is set to point to the obtained storage

**\*** The parameter list itself, name SMMC\_ADDRESS, is used to keep the address.

### GET\_LENGTH(name4 | (Rn) | expression)

specifies the number of bytes of storage you want, expressed in any of the following ways:

#### name4

The name of a fullword specifying, in binary, the number of bytes

**(Rn)** A register containing, in binary, the number of bytes

#### expression

A valid assembler-language expression; for instance, a number, a symbolic expression, or a combination of the two.

If you request TERMINAL storage, the length you specify should not include the length of the storage accounting area (SAA). The maximum length you can specify is 65 515 bytes. CICS storage management adds an 8-byte SAA, and the address returned by the XPI call is that of the start of the SAA.

If you request CICS24, CICS, USER24, USER, SHARED\_CICS24, SHARED\_CICS, SHARED\_USER24, or SHARED\_USER storage, you need only specify the length needed by your program. The address returned is that of the start of your data storage. The maximum size of storage for these storage classes is the same as the size of the DSA from which they are allocated.

### INITIAL\_IMAGE(name1 | literalconst)

specifies the initializing pattern. For example, you might want to set the acquired storage to binary zeros.

#### name1

The name of a location where the one-byte initializing pattern is stored

#### literalconst

A number in the form of a literal, for example B'00000000', X'FF', X'FC', "0", or an equate symbol with a similar value.

**STORAGE\_CLASS(CICS|CICS24|SHARED\_CICS|SHARED\_CICS24|SHARED\_USER|SHARED\_USER24|USER|USER24|TERMINAL)**

specifies the class of the storage that is the subject of the call. The values you can assign to this option, and the type of storage each represents, are listed in Table 20.

Table 20. CICS storage classes

STORAGE_CLASS	Type of storage
CICS	Task-lifetime CICS-key storage above 16MB
CICS24	Task-lifetime CICS-key storage below 16MB
SHARED_CICS	Shared CICS-key storage above 16MB
SHARED_CICS24	Shared CICS-key storage below 16MB
SHARED_USER	Shared user-key storage above 16MB
SHARED_USER24	Shared user-key storage below 16MB
TERMINAL	This class of storage has an 8-byte SAA.
USER	Task-lifetime user-key storage above 16MB
USER24	Task-lifetime user-key storage below 16MB

You must specify a storage class on a GETMAIN request. On a FREEMAIN request it is an optional parameter, and any value that you specify is not checked by CICS.

**SUSPEND(YES|NO)**

specifies whether to suspend your request if there is less storage available than you have asked for on the GET\_LENGTH option.

**TCTTE\_ADDRESS(name4 | (Ra))**

specifies the address of the terminal control table terminal entry (TCTTE). On GETMAIN requests, you must code this option if, on the STORAGE\_CLASS option, you specify a class of TERMINAL. On FREEMAIN requests, you must code it if you are freeing TERMINAL-class storage.

**Note:** Before obtaining TERMINAL class storage, check TCAFCI bit 7 to ensure that the TCA is running under a terminal.

**name4**

The name of a fullword containing the address

**(Ra)** A register that points to the TCTTE.

## RESPONSE and REASON values for GETMAIN:

RESPONSE	REASON
OK	None
EXCEPTION	INSUFFICIENT_STORAGE
DISASTER	None
INVALID	None
KERNERROR	None
PURGED	None

### Note:

1. For more detail, refer to the explanation of RESPONSE and REASON in "Making an XPI call" on page 308.



2. 'INSUFFICIENT\_STORAGE' is returned if the GETMAIN request was specified with SUSPEND(NO), and there was not enough storage available to satisfy the request.
3. 'PURGED' is returned if the GETMAIN request was specified with SUSPEND (YES), there was not enough storage to satisfy the request, and the task was purged.

## The FREEMAIN call

FREEMAIN releases an area of storage that is currently allocated to your exit program.

### FREEMAIN

```
DFHSMCX [CALL,]
  [CLEAR,]
  [IN,
  FUNCTION(FREEMAIN),
  ADDRESS(name4 | (Rn) | *),
  [STORAGE_CLASS(CICS|CICS24|SHARED_CICS|SHARED_CICS24|
    SHARED_USER|SHARED_USER24|USER|USER24|TERMINAL),]
  [TCTTE_ADDRESS(pointer),]
  [OUT,
  RESPONSE(name1 | *),
  REASON(name1 | *)]
```

This command is threadsafe.

The explanation of the options is the same as that given above for the GETMAIN function.

### RESPONSE and REASON values for FREEMAIN:

<i>RESPONSE</i>	<i>REASON</i>
OK	None
EXCEPTIONNone	None
DISASTER	None
INVALID	None
KERNERROR	None
PURGED	None

**Note:** For more detail, refer to the explanation of RESPONSE and REASON in "Making an XPI call" on page 308.

## The INQUIRE\_ACCESS call

INQUIRE\_ACCESS returns the access-key of an element of storage specified by start address and length. If the element is not wholly contained within one of the CICS dynamic storage areas (DSAs), CICS returns an exception response.

### INQUIRE\_ACCESS

```
DFHMSRX [CALL,]
  [CLEAR,]
  [IN,
  FUNCTION(INQUIRE_ACCESS),
  ELEMENT_ADDRESS(name4 | (Rn) | *),
  ELEMENT_LENGTH(name4 | (Rn) | *),]
```

```
[OUT,
ACCESS(CICS | READ_ONLY | USER),
RESPONSE(name1 | *),
REASON(name1 | *)]
```

This command is threadsafe.

**ACCESS(CICS|READ\_ONLY|USER)**

returns the access-key of the storage element.

**CICS** CICS-key

**READ\_ONLY**

Readonly storage

**USER** User-key.

**ELEMENT\_ADDRESS(name4 | (Rn) | \*)**

specifies the address of the storage element.

**ELEMENT\_LENGTH(name4 | (Rn) | \*)**

specifies the length of the storage element, in bytes. A length of zero is treated as a length of one.

**RESPONSE and REASON values for INQUIRE\_ACCESS:**

<i>RESPONSE</i>	<i>REASON</i>
OK	None
EXCEPTION	INVALID_ELEMENT
DISASTER	None
INVALID	None
KERNERROR	None

## The INQUIRE\_ELEMENT\_LENGTH call

INQUIRE\_ELEMENT\_LENGTH enables you to pass the address of any part of an element of task-lifetime storage, and to obtain from CICS the start address and the length of the storage element that contains the passed address.

### INQUIRE\_ELEMENT\_LENGTH

```
DFHSMCX [CALL,]
         [CLEAR,]
         [IN,
FUNCTION (INQUIRE_ELEMENT_LENGTH),
ADDRESS (name4 | (Rn) | *),]
         [OUT,
ELEMENT_ADDRESS(name4 | (Rn) | *),
ELEMENT_LENGTH(name4 | (Rn) | *),
RESPONSE (name1 | *),
REASON (name1 | *)]
```

This command is threadsafe.

**ADDRESS(name4 | (Rn) | \*)**

specifies an address that lies within an element of task-lifetime storage of the current task.

CICS accepts addresses that reference the leading or trailing check zones as being valid addresses for the element of storage you are inquiring upon.

**ELEMENT\_ADDRESS**(name4 | (Rn) | \*)

returns the start address of the element of task-lifetime storage referenced by the ADDRESS parameter. The start address returned does **not** include the leading check zone.

**ELEMENT\_LENGTH**(name4 | (Rn) | \*)

returns the length of the element of task-lifetime storage referenced by the ADDRESS parameter. The length returned does **not** include the leading or trailing check zones.

### **RESPONSE and REASON values for INQUIRE\_ELEMENT\_LENGTH:**

<i>RESPONSE</i>	<i>REASON</i>
OK	None
EXCEPTION	INVALID_ADDRESS
DISASTER	None
INVALID	None
KERNERROR	None
PURGED	None

## **The INQUIRE\_SHORT\_ON\_STORAGE call**

INQUIRE\_SHORT\_ON\_STORAGE enables you to determine whether CICS is short on storage:

- above or below the 16MB line
- above the 2GB bar

### **INQUIRE\_SHORT\_ON\_STORAGE**

```
DFHMSRX [CALL,]  
        [CLEAR,]  
        [IN,  
        FUNCTION(INQUIRE_SHORT_ON_STORAGE),]  
        [OUT,  
        SOS_ABOVE_THE_BAR(NO|YES),  
        SOS_ABOVE_THE_LINE(NO|YES),  
        SOS_BELOW_THE_LINE(NO|YES),  
        RESPONSE (name1 | *),  
        REASON (name1 | *)]
```

This command is threadsafe.

**SOS\_ABOVE\_THE\_BAR(NO|YES),**

returns YES if CICS is currently short-on-storage above the 2GB boundary, and NO if not.

**SOS\_ABOVE\_THE\_LINE(NO|YES),**

returns YES if CICS is currently short-on-storage above the 16MB line (and below the 2GB boundary), and NO if not.

**SOS\_BELOW\_THE\_LINE(NO|YES),**

returns YES if CICS is currently short-on-storage below the 16MB line, and NO if not.

## RESPONSE and REASON values for INQUIRE\_SHORT\_ON\_STORAGE:

<i>RESPONSE</i>	<i>REASON</i>
OK	None
DISASTER	None
KERNERROR	None

## The INQUIRE\_TASK\_STORAGE call

INQUIRE\_TASK\_STORAGE enables you to request details of all elements of task-lifetime storage belonging to a task. You can specify the transaction number of the task explicitly on the call, or let it default to the current task.

### INQUIRE\_TASK\_STORAGE

```
DFHSMCX [CALL,]  
  [CLEAR,]  
  [IN,  
  FUNCTION (INQUIRE_TASK_STORAGE),  
  [TRANSACTION_NUMBER(name4 | (Rn) | *),]  
  ELEMENT_BUFFER(buffer-descriptor),  
  LENGTH_BUFFER(buffer-descriptor),]  
  [OUT,  
  NUMBER_OF_ELEMENTS(name4 | (Rn) | *),  
  RESPONSE (name1 | *),  
  REASON (name1 | *)]
```

This command is threadsafe.

#### ELEMENT\_BUFFER(buffer-descriptor)

defines the address and length of a buffer into which CICS returns a list of start addresses of all the elements of task-lifetime storage belonging to either the specified task or, by default, the current task.

The start addresses returned do **not** include the leading check zone. For a description of a buffer descriptor, see buffer-descriptor.

#### LENGTH\_BUFFER(buffer-descriptor)

defines the address and length of a buffer into which CICS returns a list of the lengths of the elements of task-lifetime storage belonging to either the specified task or, by default, the current task. The lengths returned do **not** include the leading or trailing check zones.

For a description of a buffer descriptor, see buffer-descriptor.

#### NUMBER\_OF\_ELEMENTS(name4 | (Rn) | \*)

returns the number of entries in each of the two buffers, ELEMENT\_BUFFER and LENGTH\_BUFFER, as a full-word binary value.

#### TRANSACTION\_NUMBER(name4 | (Rn) | \*)

specifies, as a 4 byte packed decimal value, the transaction number of the task to whom the storage belongs.

If you omit the transaction (task) number, CICS assumes the current task.

## RESPONSE and REASON values for INQUIRE\_TASK\_STORAGE:

<i>RESPONSE</i>	<i>REASON</i>
OK	None
EXCEPTION	INSUFFICIENT_STORAGE

<i>RESPONSE</i>	<i>REASON</i>
	NO_TRANSACTION_ENVIRONMENT
DISASTER	None
INVALID	None
KERNERROR	None
PURGED	None

## The SWITCH\_SUBSPACE call

SWITCH\_SUBSPACE causes CICS to switch from a subspace to base space, if the task is not already executing in the base space. If the task is already in the base space, storage manager ignores the call.

This function can be used by global user exit programs that receive control in subspace and for some reason need to switch into basespace.

### SWITCH\_SUBSPACE

```
DFHMSRX [CALL,]
        [CLEAR,]
        [IN,
        FUNCTION(SWITCH_SUBSPACE),
        SPACE(BASESPACE),]
        [OUT,
        RESPONSE (name1 | *),
        REASON (name1 | *)]
```

This command is threadsafe.

#### SPACE(BASESPACE)

specifies that CICS is to switch the task issuing the call to the basespace, if it is currently executing within a subspace. This enables the task to read and write to another task's user-key task-lifetime storage.

#### RESPONSE and REASON values for SWITCH\_SUBSPACE:

<i>RESPONSE</i>	<i>REASON</i>
OK	None
DISASTER	None
KERNERROR	None

---

## Trace control XPI function

There is one XPI trace control function. This is the DFHTRPTX call TRACE\_PUT.

**DFHTRPTX calls cannot be used** in any exit program invoked from any global user exit point in the:

- Dispatcher domain
- Dump domain
- Monitor domain
- Statistics domain
- Transient data program.

## The TRACE\_PUT call

TRACE\_PUT writes a trace entry to the active trace destinations. You should only make a TRACE\_PUT call when UEPTRON indicates that tracing is active for the function containing the exit program (see UEPTRON in DFHUEPAR). You may prefer to make “exception” trace entries, in case of serious errors, without testing UEPTRON.

If you use TRACE\_PUT to write exception trace entries, you should identify these so they are highlighted as exception trace entries by the trace formatting utility program. To identify an exception trace entry, enter the literal string ‘USEREXC’ in the DATA1 block descriptor field on the DFHTRPTX call. See Interpreting the evidence, in the *CICS Problem Determination Guide* for details of how an exception trace entry is interpreted.

### TRACE\_PUT

```
DFHTRPTX [CALL,]
          [CLEAR,]
          [IN,
          FUNCTION(TRACE_PUT),
          POINT_ID(literalconst | name2 | (Rn)),
          [DATA1(block-descriptor),]
          [DATA2(block-descriptor),]
          [DATA3(block-descriptor),]
          [DATA4(block-descriptor),]
          [DATA5(block-descriptor),]
          [DATA6(block-descriptor),]
          [DATA7(block-descriptor),]
          [RETURN_ADDR(expression | name4 | (Ra)),]
          [OUT,
          RESPONSE(name1 | *)]
```

This command is threadsafe.

#### DATA $n$ (block-descriptor)

specifies up to seven areas to be included in the data section of the trace entry. For a description of valid block-descriptors, see block-descriptor. If you specify any given DATA $n$ , then DATA1 through DATA( $n-1$ ) **must** be coded before DATA $n$ . The specified DATA items are printed in the trace output in the order specified, that is, in order of DATA1 through DATA $n$ . A 2-byte length field is printed before the data field itself. The maximum total length of the data that can be traced in one call is  $4040 - (2 * n)$  bytes, where  $n$  is the number of data fields that you specify.

#### POINT\_ID(literalconst|name2|(Rn))

specifies the trace entries made as a result of this request. Every TRACE\_PUT call within a calling domain should specify a unique POINT\_ID. This enables you to locate the origin of a trace call when examining a formatted trace. The POINT\_IDs must be in the range decimal 256 through 511 (X'100' through X'1FF'). This range is not used in CICS modules, but is reserved for user exits.

#### literalconst

A number in the form of a literal, containing the ID

#### name2

The name of a 2-byte field containing the ID

#### (Rn)

A register, the two low-order bytes of which contain the ID.

#### RETURN\_ADDR(expression|name4|(Ra))

specifies the value that appears in the return address field of the trace entry.

**expression**

A valid assembler-language expression that results in the address

**name4**

The name of a fullword containing the address

**(Ra)** A register containing the address.

**RESPONSE values for TRACE\_PUT**

The RESPONSE field is never set for the TRACE\_PUT function. This is for performance reasons. It is not considered that any useful purpose could be served by testing for this value. Note, however, that the syntax requires that RESPONSE is always specified as a parameter on the call. It is recommended that RESPONSE(\*) is always used.

**Transaction management XPI functions**

This section describes the transaction management XPI calls.

**The INQUIRE\_CONTEXT call**

INQUIRE\_CONTEXT returns information about the environment in which a transaction is running. Specifically, it provides information for transactions running in a bridge environment.

**INQUIRE\_CONTEXT**

```
DFHBRIQX [CALL,]
          [CLEAR,]
          [IN,
          FUNCTION(INQUIRE_CONTEXT),]
          [OUT,
          [CONTEXT(byte1),]
          [BRIDGE_TRANSACTION_ID(name4),]
          [BRIDGE_EXIT_PROGRAM(name8),]
          [BFB_TOKEN(name4),]
          [BRXA_TOKEN(name4),]
          [FACILITYTOKEN(name8),]
          [START_TYPE(byte1),]
          RESPONSE (name1 | *),
          REASON (name1 | *)]
```

This command is threadsafe.

**BFB\_TOKEN(name4)**

returns a pointer that contains the address of the bridge facility used by this task. Although the bridge facility is not a real terminal, it is represented by a data structure that has the same format as a TCTTE and can be mapped using the DSECT DFHTCTTE. If CONTEXT returns NORMAL, the contents of this field are meaningless.

**Note:** In earlier releases of CICS, this field was called BRIDGE\_FACILITY\_TOKEN.

**name4**

The name of a 4-byte location to receive the token.

**BRIDGE\_EXIT\_PROGRAM(name8)**

returns the name of the bridge exit program used by this task. If CONTEXT returns NORMAL, the contents of this field are meaningless.

**name8**

The name of an 8-byte location to receive the name of the bridge exit program.

**BRIDGE\_TRANSACTION\_ID(name4)**

returns the name of the bridge monitor transaction that issued a START BREXIT TRANSID command to start this transaction. If CONTEXT returns NORMAL, the contents of this field are meaningless.

**name4**

The name of a 4-byte location to receive the name of the bridge monitor transaction.

**BRXA\_TOKEN(name4)**

returns a token that contains the address of the bridge exit area (BRXA) used by this task. The BRXA is not applicable to the Link3270 bridge (START\_TYPE=BRIQ\_LINK). The format of BRXA is defined by the DFHBRARx copy books. If CONTEXT returns NORMAL, the contents of this field are meaningless.

**name4**

The name of a 4-byte location to receive the token.

**CONTEXT(byte1)**

returns, in a 1-byte location (*byte1*), the type of environment in which the transaction is running.

**BRIDGE**

A user transaction that was started using a bridge

**BREXIT**

A bridge exit program

**NORMAL**

A transaction that is not running in a bridge environment.

**FACILITYTOKEN(name8)**

returns the facilitytoken ( an identifier associated with the bridge facility). If CONTEXT returns NORMAL, the contents of this field are meaningless.

**name8**

The name of an 8-byte location to receive the facilitytoken.

**START\_TYPE(byte1)**

returns, in a 1-byte location (*byte1*), an indication of how the 3270 bridge was started. If CONTEXT returns NORMAL, the contents of this field are meaningless.

**BRIQ\_START**

The bridge was started using START BREXIT.

**BRIQ\_LINK**

The bridge was started using the Link3270 mechanism.

**RESPONSE and REASON values for INQUIRE\_CONTEXT:**

<i>RESPONSE</i>	<i>REASON</i>
OK	None
DISASTER	ABEND
	LOOP
INVALID	None
EXCEPTION	NO_TRANSACTION_ENVIRONMENT
KERNERROR	None



## The INQUIRE\_DTRTRAN call

INQUIRE\_DTRTRAN returns the name of the dynamic transaction routing (DTR) transaction definition.

The DTR transaction definition provides common attributes for transactions that are to be dynamically routed and which do not have a specific transaction definition. It is specified on the DTRTRAN system initialization parameter; the CICS-supplied default definition is CRTX.

### INQUIRE\_DTRTRAN

```
DFHXMSRX [CALL,]
          [CLEAR,]
          [IN,
          FUNCTION(INQUIRE_DTRTRAN),]
          [OUT,
          DTRTRAN(name4),
          RESPONSE (name1 | *),
          REASON (name1 | *)]
```

This command is threadsafe.

#### DTRTRAN (name4)

returns the name of the DTR transaction definition to used for routing transactions that are not defined by an explicit transaction resource definition.

#### name4

The name of a 4-byte location that is to receive the name of the DTR transaction definition. If 'NO' was specified on the DTRTRAN system initialization parameter, 'NO' will be placed in this field.

### RESPONSE and REASON values for INQUIRE\_DTRTRAN:

<i>RESPONSE</i>	<i>REASON</i>
OK	None
DISASTER	ABEND
	LOGIC_ERROR
	LOOP
INVALID	INVALID_FUNCTION
KERNERROR	None
PURGED	None

## The INQUIRE\_MXT call

The INQUIRE\_MXT function is provided on the DFHXMSRX macro call. Its purpose is to provide current value of the MXT parameter.

### INQUIRE\_MXT

```
DFHXMSRX [CALL,]
          [CLEAR,]
          [IN,
          FUNCTION(INQUIRE_MXT),]
          [OUT,
          CURRENT_ACTIVE(name4 | (Rn) ),
          MXT_LIMIT(name4 | (Rn)),
```

```

MXT_QUEUED(name4 | (Rn) ),
TCLASS_QUEUED(name4 | (Rn) ),
RESPONSE (name1 | *),
REASON (name1 | *)]

```

This command is threadsafe.

**CURRENT\_ACTIVE(name4 | (Rn))**

returns the current number of all active user tasks.

**name4**

The name of a 4-byte location that is to receive the current number of active user tasks, expressed as a binary value.

**(Rn)** A register to receive the current number of active user tasks, expressed as a binary value.

**MXT\_LIMIT(name4 | (Rn))**

returns the current number of the MXT parameter.

**name4**

The name of a 4-byte location that is to receive the maximum number of all user tasks currently allowed, expressed as a binary value.

**(Rn)** A register to receive the maximum number of all tasks currently allowed, expressed as a binary value.

**MXT\_QUEUED(name4 | (Rn))**

returns the current number of user transactions that are queued as a result of the maximum tasks (MXT) being reached.

**name4**

The name of a 4-byte location that is to receive the current number of queued user tasks, expressed as a binary value.

**(Rn)** A register to receive the current number of queued user tasks, expressed as a binary value.

**TCLASS\_QUEUED(name4 | (Rn))**

returns the current number of all transactions that are queued for transaction class membership.

**name4**

The name of a 4-byte location that is to receive the current number of queued transaction class members, expressed as a binary value.

**(Rn)** A register to receive the current number of queued transaction class members, expressed as a binary value.

**RESPONSE and REASON values for INQUIRE\_MXT:**

<i>RESPONSE</i>	<i>REASON</i>
OK	None
DISASTER	LOGIC_ERROR
	ABEND
	LOOP
INVALID	INVALID_FUNCTION
KERNERROR	None
PURGED	None

## The INQUIRE\_TCLASS call

The INQUIRE\_TCLASS function is provided on the DFHXMCLX macro call. Its purpose is to provide current information about the specified transaction class (TCLASS).

### INQUIRE\_TCLASS

```
DFHXMCLX [CALL,]
          [CLEAR,]
          [IN,
          FUNCTION(INQUIRE_TCLASS),
          INQ_TCLASS_NAME(name8 | string | 'string'),]
          [OUT,
          [CURRENT_ACTIVE(name4 | (Rn)),]
          [CURRENT_QUEUED(name4 | (Rn)),]
          [MAX_ACTIVE(name4 | (Rn)),]
          [PURGE_THRESHOLD(name4 | (Rn)),]
          RESPONSE (name1 | *),
          REASON (name1 | *)]
```

This command is threadsafe.

#### **CURRENT\_ACTIVE(name4 | (Rn))**

returns the current number of active user tasks in this transaction class.

##### **name4**

The name of a 4-byte location that is to receive the current number of active user tasks for this transaction class, expressed as a binary value.

**(Rn)** A register to receive the current number of active user tasks for this transaction class, expressed as a binary value.

#### **CURRENT\_QUEUED(name4 | (Rn))**

returns the current number of queued user tasks.

##### **name4**

The name of a 4-byte location that is to receive the current number of queued user tasks in this transaction class, expressed as a binary value.

**(Rn)** A register to receive the current number of queued user tasks, expressed as a binary value.

#### **INQ\_TCLASS\_NAME(name8 | string | 'string')**

specifies the name of the transaction class for this inquiry.

##### **name8**

The name of an 8-byte location that contains the name of the transaction class being inquired on.

**string** A string of characters, without intervening blanks, naming the transaction class.

##### **'string'**

A string of characters, within quotation marks, naming the transaction class. The string length is set to 8 by padding with blanks within the quotation marks.

#### **MAX\_ACTIVE(name4 | (Rn))**

returns the current maximum number of active tasks allowed for the transaction class.

**name4**

The name of a 4-byte location that is to receive the current maximum number of active tasks currently allowed for this transaction class, expressed as a binary value.

**(Rn)** A register to receive the current maximum number of active tasks currently allowed for this transaction class, expressed as a binary value.

**PURGE\_THRESHOLD(name4 | (Rn))**

returns the purge threshold limit for this transaction class.

**name4**

The name of a 4-byte location that is to receive the current purge threshold limit for this transaction class, expressed as a binary value.

**(Rn)** A register to receive the current purge threshold limit for this transaction class, expressed as a binary value.

**RESPONSE and REASON values for INQUIRE\_TCLASS:**

<i>RESPONSE</i>	<i>REASON</i>
OK	None
DISASTER	LOGIC_ERROR
INVALID	None
EXCEPTION	UNKNOWN_CLASS

## The INQUIRE\_TRANDEF call

The INQUIRE\_TRANDEF function is provided on the DFHMXDX macro call. Its purpose is to allow you to obtain information about the specified transaction definition. In general, this function call is equivalent to the EXEC CICS INQUIRE TRANSACTION command, with some differences.

**INQUIRE\_TRANDEF**

```
DFHMXDX [CALL,]
        [CLEAR,]
        [IN,
        FUNCTION(INQUIRE_TRANDEF),
        INQ_TRANSACTION_ID(name4 | string | 'string'),]
        [OUT,
        [BEXIT(name8),]
        [CMDSEC(name1),]
        [DTIMEOUT(name4 | (Rn)),]
        [DUMP(name1),]
        [DYNAMIC(name1),]
        [INDOUBT(name1),]
        [INDOUBT_WAIT(name1),]
        [INDOUBT_WAIT_TIME(name4),]
        [INITIAL_PROGRAM(name8),]
        [ISOLATE(name1),]
        [LOCAL_QUEUEING(name1),]
        [OTSTIMEOUT(name4 | (Rn)),]
        [PARTITIONSET(name1),]
        [PARTITIONSET_NAME(name8),]
        [PROFILE_NAME(name8),]
        [REMOTE(name1),]
        [REMOTE_NAME(name8),]
        [REMOTE_SYSTEM(name4),]
        [RESSEC(name1),]
        [RESTART(name1),]
        [ROUTABLE_STATUS(ROUTABLE|NOT_ROUTABLE),]
        [RUNAWAY_LIMIT(name4 | (Rn)),]
```

```

[SHUTDOWN(name1),]
[SPURGE(name1),]
[STATUS(name1),]
[STORAGE_CLEAR(name1),]
[STORAGE_FREEZE(name1),]
[SYSTEM_ATTACH(name1),]
[SYSTEM_RUNAWAY(name1),]
[TASKDATAKEY(name1),]
[TASKDATALOC(name1),]
[TCLASS(name1), [TCLASS_NAME(name8),]]
[TPURGE(name1),]
[TRACE(name1),]
[TRAN_PRIORITY(name4 | (Rn)),]
[TRAN_ROUTING_PROFILE(name8),]
[TRANSACTION_ID(name4),]
[TWASIZE(name4 | (Rn)),]
RESPONSE (name1 | *),
REASON (name1 | *)]

```

This command is threadsafe.

The following parameter descriptions explain briefly the possible values that can be returned on an INQUIRE\_TRANDEF call. For a more detailed explanation of some of these parameters, see the corresponding parameter descriptions for the TRANSACTION resource definition in TRANSACTION definition attributes, in the *CICS Resource Definition Guide*.

**BREXIT(name8)**

returns the name of the default bridge exit program specified for the named transaction. If no bridge exit is specified, blanks are returned.

**name8**

The name of an 8-byte location to receive the name of the bridge exit program.

**CMDSEC(name1)**

returns, in a 1-byte location (*name1*), an equated value indicating whether command security checking is required for the transaction.

**MXD\_YES**

Command security checking is required.

**MXD\_NO**

Command security checking is not required.

**DTIMEOUT(name4)**

returns the deadlock time-out value for the transaction.

**name4**

The name of a 4-byte location that is to receive the deadlock time-out value, expressed as a binary value.

**(Rn)**

A register to receive the deadlock time-out value, expressed as a binary value.

Note that a value of zero means that the transaction resource definition specifies DTIMOUT(NO).

**DUMP(name1)**

returns, in a 1-byte location (*name1*), an equated value indicating whether CICS is to take a transaction dump if the transaction abends.

**MXD\_YES**

A transaction dump is required.

**XXMD\_NO**

A transaction dump is not required.

**DYNAMIC(name1)**

returns, in a 1-byte location (*name1*), an equated value indicating whether the transaction is defined for dynamic transaction routing.

**XXMD\_YES**

The transaction is to be dynamically routed to a remote CICS.

**XXMD\_NO**

The transaction is not to be dynamically routed.

**INDOUBT(name1)**

returns, in a 1-byte location (*name1*), an equated value indicating the action to be taken if the CICS region fails or loses connectivity with its coordinator while a unit of work is in the in-doubt period. (The action is based on the ACTION attribute of the TRANSACTION resource definition.)

The action is dependent on the values returned in INDOUBT\_WAIT and INDOUBT\_WAIT\_TIME; if INDOUBT\_WAIT returns XXMD\_YES, the action is not taken until the time returned in INDOUBT\_WAIT\_TIME expires.

**XXMD\_BACKOUT**

Any changes made by the transaction to recoverable resources are to be backed out.

**XXMD\_COMMIT**

Any changes made by the transaction to recoverable resources are to be committed.

**INDOUBT\_WAIT(name1)**

returns, in a 1-byte location (*name1*), an equated value indicating how a unit of work (UOW) is to respond if a failure occurs while it is in an in-doubt state.

**XXMD\_NO**

The UOW is not to wait, pending recovery from the failure. CICS is to take immediately whatever action is specified on the ACTION attribute of the TRANSACTION definition.

**XXMD\_YES**

The UOW is to wait, pending recovery from the failure, to determine whether recoverable resources are to be backed out or committed.

**INDOUBT\_WAIT\_TIME(name4)**

returns the length of time, in minutes, after a failure during the in-doubt period, before the transaction is to take the action returned in the INDOUBT field. The returned value is valid only if the unit of work is in-doubt and INDOUBT\_WAIT returns XXMD\_YES.

**name4**

The name of a 4-byte location that is to receive the delay time, expressed as a binary value.

See also INDOUBT and INDOUBT\_WAIT.

**INITIAL\_PROGRAM(name8)**

returns the name of the initial program to be given control for the transaction.

**name8**

The name of an 8-byte location to receive the initial program name.

**INQ\_TRANSACTION\_ID(name4 | string | 'string')**

specifies the transaction identifier for this transaction definition inquiry.

**name4**

The name of a 4-byte location that contains the name of the transaction identifier.

**string** A string of characters, without intervening blanks, naming the transaction identifier.

**'string'**

A string of characters, within quotation marks, naming the transaction identifier. The string length is set to 4 by padding with blanks within the quotation marks.

**ISOLATE(name1)**

returns, in a 1-byte location (*name1*), an equated value indicating whether transaction isolation is required for the transaction's task-lifetime user-key storage.

**XMxD\_NO**

Transaction isolation is not required for task-lifetime user-key storage.

**XMxD\_YES**

Transaction isolation is required for task-lifetime user-key storage.

**LOCAL\_QUEUEING(name1)**

returns, in a 1-byte location (*name1*), an equated value indicating whether a start request for this transaction is eligible to queue locally if the transaction is to be started on another system, and the remote system is not available.

**XMxD\_NO**

The request is not to be queued locally.

**XMxD\_YES**

The request can be queued locally.

**OTSTIMEOUT(name4)**

returns the default period in seconds that an Object Transaction Service (OTS) transaction created in an Enterprise JavaBeans (EJB) environment and executing under this CICS transaction is allowed to execute without the initiator of the OTS transaction taking a syncpoint (or rolling back the OTS transaction).

**name4**

The name of a 4-byte location to receive the timeout setting, expressed as a binary value.

**(Rn)** A register to receive the timeout setting, expressed as a binary value.

A value of zero means that the transaction resource definition specifies OTSTIMEOUT(NO).

**PARTITIONSET(name1)**

returns, in a 1-byte location (*name1*), an equated value indicating the partitionset specified on the transaction definition.

**XMxD\_KEEP**

The reserved name KEEP is specified for the partitionset, which means tasks running under this transaction definition use the application partitionset for the terminal associated with the transaction.

**XMxD\_NAMED**

The partitionset is named specifically on the transaction definition. The name is returned on the PARTITIONSET\_NAME parameter.

**XMxD\_NONE**

There is no partitionset specified for the transaction definition.

**XXMD\_OWN**

The reserved name OWN is specified for the partitionset, which means tasks running under this transaction definition perform their own partitionset management.

**PARTITIONSET\_NAME(name8)**

returns the name of the partitionset defined on the transaction definition.

**name8**

The name of an 8-byte location that is to receive the name of the partitionset.

**PROFILE\_NAME(name8)**

returns the name of the profile definition that is associated with the transaction definition.

**name8**

The name of an 8-byte location to receive the name of the profile definition associated with the transaction definition.

**REMOTE(name1)**

returns, in a 1-byte location (*name1*), an equated value indicating whether the transaction is defined as remote.

**XXMD\_NO**

The transaction is not a remote transaction.

**XXMD\_YES**

The transaction is a remote transaction.

**REMOTE\_NAME(name8)**

returns the name by which the transaction is known in a remote system.

**name8**

The name of an 8-byte location to receive the transaction's remote name.

**REMOTE\_SYSTEM(name4)**

returns the name of the remote system as specified on the transaction definition.

If the DYNAMIC parameter returns XXMD\_YES, REMOTE\_SYSTEM returns the default name, which can be changed by the dynamic routing program.

If the DYNAMIC parameter returns XXMD\_NO, this is the actual remote system to which the transaction is to be routed.

**name4**

The name of a 4-byte location to receive the defined name of the remote system.

**RESSEC(name1)**

returns, in a 1-byte location (*name1*), an equated value indicating whether resource security checking is required for the transaction.

**XXMD\_NO**

Resource security checking is not required.

**XXMD\_YES**

Resource security checking is required.

**RESTART(name1)**

returns, in a 1-byte location (*name1*), an equated value indicating whether the transaction is to be considered for transaction restart.



**XXMD\_NO**

The transaction cannot be restarted.

**XXMD\_YES**

The transaction can be restarted.

**ROUTABLE\_STATUS(ROUTABLE|NOT\_ROUTABLE)**

returns a value indicating whether, if the transaction is the subject of an eligible EXEC CICS START command, it will be routed using the enhanced routing method.

**NOT\_ROUTABLE**

If the transaction is the subject of a START command, it will be routed using the “traditional” method.

**ROUTABLE**

If the transaction is the subject of an eligible START command, it will be routed using the enhanced method.

For details of the enhanced and “traditional” methods of routing transactions invoked by EXEC CICS START commands, see CICS transaction routing, in the *CICS Intercommunication Guide*.

**RUNAWAY\_LIMIT(name4 | (Rn))**

returns the runaway-task time limit specified on the transaction definition. If SYSTEM\_RUNAWAY is XXMD\_YES, the value returned is the value defined by the ICVR system initialization parameter.

**name4**

The name of a 4-byte location that is to receive the task runaway limit, expressed as a binary value.

**(Rn)** A register to receive the task runaway limit, expressed as a binary value.

**SHUTDOWN(name1)**

returns, in a 1-byte location (*name1*), an equated value indicating whether the transaction can be run during CICS shutdown.

**XXMD\_DISABLED**

The transaction is disabled from running during CICS shutdown.

**XXMD\_ENABLED**

The transaction is enabled to run during CICS shutdown.

**SPURGE(name1)**

returns, in a 1-byte location (*name1*), an equated value indicating whether the transaction is defined as system-purgeable.

**XXMD\_NO**

The transaction is not system-purgeable.

**XXMD\_YES**

The transaction is system-purgeable.

**STATUS(name1)**

returns, in a 1-byte location (*name1*), an equated value indicating the status of the transaction definition.

**XXMD\_DISABLED**

The transaction definition is disabled.

**XXMD\_ENABLED**

The transaction definition is enabled.

**STORAGE\_CLEAR(name1)**

returns, in a 1-byte location (*name1*), an equated value indicating whether task-lifetime storage, of tasks associated with this transaction definition, is to be cleared before it is freed by a FREEMAIN command.

**XXMD\_NO**

Task-lifetime storage need not be cleared before it's freed.

**XXMD\_YES**

Task-lifetime storage must be cleared before it's freed.

**STORAGE\_FREEZE(name1 | (Rn))**

returns, in a 1-byte location (*name1*), an equated value indicating whether storage freeze is defined for the transaction by means of the STGFRZ option on the CICS-supplied field engineering transaction, CSFE.

**XXMD\_NO**

Storage is freed normally during the running of the transaction.

**XXMD\_YES**

Storage that is normally freed during the running of a transaction is frozen.

**SYSTEM\_ATTACH(name1)**

returns, in a 1-byte location (*name1*), an equated value indicating whether the tasks attached with this tranid are always to be attached as system tasks.

**XXMD\_NO**

A user task is being attached for this transaction.

**XXMD\_YES**

A system task is being attached for this transaction.

**SYSTEM\_RUNAWAY(name1)**

returns, in a 1-byte location (*name1*), an equated value indicating whether the transaction definition specifies the system default runaway-task time limit, which is specified on the ICVR system initialization parameter.

**XXMD\_NO**

The transaction is not governed by the system runaway limit.

**XXMD\_YES**

The transaction definition specifies the system default runaway limit.

**TASKDATAKEY(name1)**

returns, in a 1-byte location (*name1*), an equated value indicating the storage key of task-lifetime storage for tasks associated with this transaction definition.

**XXMD\_CICS**

CICS key is specified for task-lifetime storage.

**XXMD\_USER**

USER key is specified for task-lifetime storage.

**TASKDATALOC(name1)**

returns, in a 1-byte location (*name1*), an equated value indicating the data location of task-lifetime storage for tasks associated with this transaction definition.

**XXMD\_ANY**

Task-lifetime storage can be located above 16MB in virtual storage.

**XXMD\_BELOW**

Task-lifetime storage must be located below 16MB in virtual storage.

**TCLASS(name1)**

returns, in a 1-byte location (*name1*), an equated value indicating whether the transaction belongs to a transaction class.

**XXMD\_NO**

The transaction is not a member of a transaction class.

**XXMD\_YES**

The transaction is a member of the transaction class named in the TCLASS\_NAME parameter.

**TCLASS\_NAME(name8)**

returns the name of the transaction class to which the transaction belongs.

**name8**

The name of an 8-byte location to receive transaction class name to which the transaction belongs.

**TPURGE(name1)**

returns, in a 1-byte location (*name1*), an equated value indicating whether the transaction is defined as purgeable in the event of a VTAM terminal error.

**XXMD\_NO**

The transaction can not be purged if a terminal error occurs.

**XXMD\_YES**

The transaction can be purged if a terminal error occurs.

**TRACE(name1)**

returns, in a 1-byte location (*name1*), an equated value indicating the level of tracing defined for the transaction:

**XXMD\_SPECIAL**

CICS special-level trace This is the result of special trace being set by means of an EXEC CICS SET TRANSACTION command.

**XXMD\_STANDARD**

CICS standard-level trace This equates to TRACE(YES) in the TRANSACTION resource definition.

**XXMD\_SUPPRESSED**

Tracing is suppressed for the transaction This equates to TRACE(NO) in the TRANSACTION resource definition.

**TRAN\_PRIORITY(name4 | (Rn))**

returns the transaction priority specified on the transaction definition.

**name4**

The name of a 4-byte location to receive the transaction priority, expressed as a binary value.

**(Rn)**

A register to receive the transaction priority, expressed as a binary value.

**TRAN\_ROUTING\_PROFILE(name8)**

returns the name of the profile that CICS is to use to route the transaction to a remote system.

**name8**

The name of an 8-byte location to receive the transaction-routing profile.

**TRANSACTION\_ID(name4)**

returns the primary transaction identifier for this transaction definition inquiry.

**name4**

The name of a 4-byte location that contains the name of the transaction identifier.

**TWASIZE(name4 | (Rn))**

returns the size of the transaction work area specified on the transaction definition.

**name4**

The name of a 4-byte location to receive the size of the transaction work area, expressed as a binary value.

**(Rn)** A register to receive the size of the transaction work area, expressed as a binary value.

**RESPONSE and REASON values for INQUIRE\_TRANDEF:**

<i>RESPONSE</i>	<i>REASON</i>
OK	None
EXCEPTION	UNKNOWN_TRANSACTION_ID
INVALID	None
DISASTER	LOGIC_ERROR
PURGED	None

## The INQUIRE\_TRANSACTION call

The INQUIRE\_TRANSACTION function is provided on the DFHXMIQX macro call. Its purpose is to allow you to obtain information about a transaction that is attached (task). In general, this call is equivalent to the EXEC CICS INQUIRE TASK command, with some minor differences.

### INQUIRE\_TRANSACTION

```
DFHXMIQX [CALL,]
          [CLEAR,]
          [IN,
          FUNCTION(INQUIRE_TRANSACTION),
          [TRANSACTION_TOKEN(name8),,]
          [OUT,
          [ATTACH_TIME(name8),,]
          [CICS_UOW_ID(name8),,]
          [DTIMEOUT(name4 | (Rn)),,]
          [DYNAMIC(name1),,]
          [FACILITY_NAME(name4),,]
          [FACILITY_TYPE(name1),,]
          [INITIAL_PROGRAM(name8),,]
          [NETNAME(name8),,]
          [ORIGINAL_TRANSACTION_ID(name4),,]
          [OUT_TRANSACTION_TOKEN(name8),,]
          [RE_ATTACHED_TRANSACTION(name1),,]
          [REMOTE(name1),,]
          [REMOTE_NAME(name8),,]
          [REMOTE_SYSTEM(name4),,]
          [RESOURCE_NAME(name8),,]
          [RESOURCE_TYPE(name8),,]
          [RESTART(name1),,]
          [RESTART_COUNT(name2 | (Rn)),,]
          [SPURGE(name1),,]
          [START_CODE(name1),,]
          [STATUS(name1),,]
          [SUSPEND_TIME(name4 | (Rn)),,]
          [SYSTEM_TRANSACTION(name1),,]
```

```

[TASK_PRIORITY(name1),]
[TCLASS(name1), [TCLASS_NAME(name8),]]
[TERMINATE_PROTECTED(name1),] [TPURGE(name1),]
[TRANUM(name4 | string | 'string'),]
[TRAN_PRIORITY(name1),]
[TRAN_ROUTING_PROFILE(name8),]
[TRANSACTION_ID(name4),]
[USERID(name8),]
RESPONSE (name1 | *),
REASON (name1 | *)]

```

This command is threadsafe.

The descriptions of the following parameters are the same as the corresponding parameters on the INQUIRE\_TRANDEF function call.

```

DTIMEOUT
DYNAMIC
INITIAL_PROGRAM
REMOTE
REMOTE_NAME
REMOTE_SYSTEM
RESTART
SPURGE
STATUS
TCLASS
TRAN_ROUTING_PROFILE
TRANSACTION_ID

```

The parameter descriptions that follow explain briefly the possible values that can be returned on an INQUIRE\_TRANSACTION call. For a more detailed explanation of these parameters, see the corresponding parameter descriptions for the TRANSACTION resource definition in TRANSACTION definition attributes, in the *CICS Resource Definition Guide*.

**ATTACH\_TIME(name8)**

returns the time in milliseconds since the task was attached.

**name8**

The name of an 8-byte location to receive the time, in packed decimal ABSTIME format.

**CICS\_UOW\_ID(name8)**

returns the CICS unit of work identifier for the task.

**name8**

The name of an 8-byte location to receive the unit of work id.

**FACILITY\_NAME(name4)**

returns the name of the principal facility associated with the task.

**name4**

The name of a 4-byte location to receive the name of the principal facility.

**FACILITY\_TYPE(name1)**

returns, in a 1-byte location (*name1*), an equated value indicating the type of principal facility associated with the task.

**XMIQ\_NONE**

There is no principal facility.

**XMIQ\_START**

The principal facility is an interval control element.

**XMIQ\_TD**

The principal facility is a transient data queue.

**XMIQ\_TERMINAL**

The principal facility is a terminal.

**NETNAME(name8)**

returns the network name of the principal facility associated with this task.

**name8**

The name of an 8-byte location to receive the network name.

**ORIGINAL\_TRANSACTION\_ID(name4)**

returns the transaction id that was used to attach the transaction. For example, if an alias was used at a terminal, this field returns the alias.

**name4**

The name of a 4-byte location to receive the name of the original transaction identifier.

**OUT\_TRANSACTION\_TOKEN(name8)**

returns the token that represents the task.

**name8**

The name of an 8-byte location to receive the transaction token for the task.

**RE\_ATTACHED\_TRANSACTION(name1)**

returns, in a 1-byte location (*name1*), an equated value indicating whether the transaction has been re-attached.

**XMIQ\_NO**

The transaction has not been re-attached and the global user exit program is invoked in the same environment as the original transaction-attach.

**XMIQ\_YES**

The transaction has been re-attached and the global user exit program is invoked in a different environment from the original transaction-attach.

**RESOURCE\_NAME(name8)**

returns the name of a resource that the (suspended) transaction waiting for.

**name8**

The name of an 8-byte location to receive the name of the resource on which the transaction is waiting.

**RESOURCE\_TYPE(name8)**

returns the type of resource that the (suspended) transaction waiting for.

**name8**

The name of an 8-byte location to receive the type of resource on which the transaction is waiting.

**RESTART\_COUNT(name2 | (Rn))**

returns the number of times this instance of the transaction has been restarted.

**name2**

The name of a 2-byte location to receive the number of times the transaction has been restarted, expressed as a half-word binary value.

**(Rn)**

A register to receive the number of times the transaction has been restarted, expressed as a half-word binary value.

**START\_CODE(name1)**

returns, in a 1-byte location (*name1*), an equated value indicating how the task was started:

**C** A CICS internal attach.

**XMIQ\_DF**

The start code isn't yet known—to be set later.

**XMIQ\_QD**

A transient data trigger level attach.

**XMIQ\_S**

A START command without any data.

**XMIQ\_SD**

A START command with data.

**XMIQ\_SZ**

A front end programming interface (FEPI) attach.

**XMIQ\_T**

A terminal input attach.

**XMIQ\_TT**

A permanent transaction terminal attach.

**SUSPEND\_TIME(name4 | (Rn))**

returns the length of time that the task has been in its current suspended state.

**name4**

The name of a 4-byte location to receive the number of seconds, rounded down, the task has been suspended, expressed as a binary value.

**(Rn)**

A register to receive the number of seconds, rounded down, the task has been suspended, expressed as a binary value.

**SYSTEM\_TRANSACTION(name1)**

returns, in a 1-byte location (*name1*), an equated value indicating whether the task is CICS system task.

**XMIQ\_NO**

The task is not a CICS system task.

**XMIQ\_YES**

The task is a CICS system task.

**TASK\_PRIORITY(name1)**

returns the combined task priority, which is the sum of the priorities defined for the terminal, transaction, and operator.

**name1**

The name of a 1-byte location to receive the task priority, expressed as a binary number.

**TERMINATE\_PROTECTED(name1)**

returns, in a 1-byte location (*name1*), an equated value indicating whether the transaction can be killed.

**XMIQ\_NO**

The transaction can be killed.

**XMIQ\_YES**

The transaction cannot be killed.

**TRANNUM(name4)**

returns the task number of the transaction.

**name4**

The name of a 4-byte location to receive the task number.

**TRANSACTION\_TOKEN(name8)**

specifies the transaction token for the task being inquired upon. This parameter is optional, and if omitted, the current task is assumed.

If you issue this call within an XXMATT global user exit program, the current task may be a CICS system task. To inquire on the user task for which XXMATT is invoked, you must specify the transaction token passed on the XXMATT exit-specific parameter list.

**name8**

The name of an 8-byte location that contains the transaction token.

**USERID(name8)**

returns the userid associated with this task.

**name8**

The name of an 8-byte location to receive the userid.

**RESPONSE and REASON values for INQUIRE\_TRANSACTION:**

<i>RESPONSE</i>	<i>REASON</i>
OK	None
DISASTER	ABEND
	LOOP
INVALID	None
EXCEPTION	NO_TRANSACTION_ENVIRONMENT
	BUFFER_TOO_SMALL
	INVALID_TRANSACTION_TOKEN
KERNERROR	None

## The SET\_TRANSACTION call

The SET\_TRANSACTION function is provided on the DFHXMIQX macro call. Its purpose is to allow you to change the task priority and transaction class of the current task.

Note that you can use this call to change the TCLASS\_NAME only when it is invoked from an XXMATT global user exit program.

**SET\_TRANSACTION**

```
DFHXMIQX [CALL,]
          [CLEAR,]
          [IN,
          FUNCTION(SET_TRANSACTION),
          [TASK_PRIORITY(name4),]
          [TCLASS_NAME(name8),]
          [TRANSACTION_TOKEN(name8),]]
          [OUT,
          RESPONSE (name1 | *),
          REASON (name1 | *)]
```

This command is threadsafe.



**TASK\_PRIORITY(name4)**

specifies the new task priority being set for the task identified by TRANSACTION\_TOKEN.

**name4**

The name of a 4-byte location that contains the new task priority number, expressed as a binary value.

**TCLASS\_NAME(name8)**

specifies the new transaction class name that you want to associate this task with. To specify that the task is not to be in any transaction class, specify the special default system name DFHTCL00.

**name8**

The name of an 8-byte location that contains the name of the new transaction class. Set this field to DFHTCL00 for no transaction class.

**TRANSACTION\_TOKEN(name8)**

specifies the transaction token that represents the task being modified. If you omit this parameter, the call defaults to the current task.

**name8**

The name of an 8-byte location that contains the transaction token.

**RESPONSE and REASON values for SET\_TRANSACTION:**

<i>RESPONSE</i>	<i>REASON</i>
OK	None
EXCEPTION	NO_TRANSACTION_ENVIRONMENT
	UNKNOWN_TCLASS
	INVALID_TRANSACTION_TOKEN
DISASTER	ABEND
	LOOP
INVALID	None
KERNERROR	None

---

## User journaling XPI function

There is one XPI user journaling function, which is the DFHJCJCX call WRITE\_JOURNAL\_DATA.

**DFHJCJCX calls cannot be used** in any exit program invoked from any global user exit point in the:

- Statistics domain
- Monitor domain
- Dump domain
- Dispatcher domain
- Transient data program.

## The WRITE\_JOURNAL\_DATA call

WRITE\_JOURNAL\_DATA writes a single journal record to the journal specified in the journal model definition that matches the journal name (either a journal on an MVS system logger log stream, an SMF data set, or no record is written where DUMMY is defined in the definition).

## WRITE\_JOURNAL\_DATA

```
DFHJCJCX [CALL,]
          [CLEAR,]
          [IN,
          FUNCTION(WRITE_JOURNAL_DATA),
          FROM(block-descriptor),
          JOURNALNAME(name8 | string | 'string' ) |
          JOURNAL_RECORD_ID(name2 | string | 'string'),
          WAIT(YES|NO),
          [RECORD_PREFIX(block-descriptor),]]
          [OUT,
          RESPONSE(name1 | *),
          REASON(name1 | *)]
```

This command is threadsafe.

### Important

There is a restriction in using the XPI early during initialization. Do not start exit programs that use the XPI functions TRANSACTION\_DUMP, WRITE\_JOURNAL\_DATA, MONITOR, and INQUIRE\_MONITOR\_DATA until the second phase of the PLTPI. For further information about the PLTPI, refer to Chapter 4, "Writing initialization and shutdown programs," on page 425.

#### **FROM(block-descriptor)**

specifies the address and the length of the journal record.

The block-descriptor comprises 8 bytes of data. The first 4 bytes hold the address of the data to be written. The second 4 bytes hold the length of the data. The block-descriptor is moved by the DFHJCJCX macro call to the location JCJC\_FROM, which is mapped by the DFHJCJCY DSECT.

#### **JOURNALNAME(name8 | string | "string")**

specifies the name of the CICS journal or log to which the FROM data is to be written.

#### **JOURNAL\_RECORD\_ID(name2 | string | "string")**

specifies a 2-character value to be written to the journal record to identify its origin.

##### **name2**

The name of a 2-byte location

**string** A character string that is limited to a length of 2 in the generated code

##### **"string"**

A character string enclosed in quotation marks, limited to a length of 2 in the generated code.

#### **RECORD\_PREFIX(block-descriptor)**

specifies the optional user prefix.

#### **WAIT(YES|NO)**

specifies whether CICS is to wait until the record is written to the journal or log before returning control to the exit program.

### **RESPONSE and REASON values for WRITE\_JOURNAL\_DATA:**

<i>RESPONSE</i>	<i>REASON</i>
OK	None
EXCEPTION	IO_ERROR
	JOURNAL_NOT_FOUND

<i>RESPONSE</i>	<i>REASON</i>
	JOURNAL_NOT_OPEN
	LENGTH_ERROR
	STATUS_ERROR
DISASTER	None
INVALID	None
KERNERROR	None
PURGED	None

**Note:** For more detail, refer to the explanation of RESPONSE and REASON in “Making an XPI call” on page 308.



---

## Part 2. Customizing with initialization and shutdown programs



---

## Chapter 4. Writing initialization and shutdown programs

You can write programs to run during the initialization and shutdown phases of CICS processing. Any program that is to run at these times must be defined to CICS in a program list table (PLT). Information about how to code the PLT is provided in the *CICS Resource Definition Guide*.

This information is divided into the following sections:

1. “Writing initialization programs”
2. “Writing shutdown programs” on page 428
3. “General considerations when writing initialization and shutdown programs” on page 429.

---

### Writing initialization programs

Any program that is to execute during CICS initialization must be specified in a program list table (PLT), and the suffix of that PLT must be named on the program list table post initialization (PLTPI) system initialization parameter.

There are two phases of program list table (PLT) execution, separated by the DFHDELIM statement in the PLT.

### First-phase PLT programs

During the early stages of CICS initialization processing, the only PLT programs that can execute are those containing the enabling commands for global and task-related user exit programs. These programs are specified in the first part of the PLTPI list (before the DFHDELIM statement). This allows you to enable those exit programs that are needed during recovery.

Dynamic LIBRARY resources will be installed, or restored and re-activated, after first stage PLT programs run, but before second stage PLT programs run. This means that first stage PLT programs must be included in data sets in DFHRPL, but second stage PLT programs can be included in, and loaded from dynamic LIBRARY resources.

The following points apply to all first-phase PLTPI programs:

- The programs must be written in assembler language.
- They must run AMODE 31.
- The only EXEC CICS commands they should contain are:
  - ASSIGN APPLID
  - ASSIGN INITPARM
  - ENABLE
  - EXTRACT EXIT

Because this stage occurs before recovery when initialization is incomplete, no other CICS services can be invoked.

- If a first-phase PLTPI program enables an exit program that issues any of the XPI calls INQUIRE\_MONITORING\_DATA, MONITOR, TRANSACTION\_DUMP, or WRITE\_JOURNAL\_DATA, it must not specify the START option on the EXEC CICS ENABLE COMMAND.

- First phase PLTPI programs must not enable any task-related user exit program with the TASKSTART option.
- Because first-phase PLT programs run so early in CICS initialization, no resource definitions are available. This means that you cannot use installed PROGRAM definitions (or the program autoinstall user program) to define first-phase PLT programs to CICS, nor to define the user exit programs that first-phase PLT programs enable. Instead, default definitions are installed automatically by CICS. Whether or not program autoinstall is specified as active on the PGAIPGM system initialization parameter, the autoinstall user program is not invoked to allow the definitions to be modified.

This type of autoinstall by CICS is known as *system autoinstall*.

CICS defines first-phase PLT programs, and the user exit programs that they enable, with the following attributes:

```
LANGUAGE(Assembler)
RELOAD(No)
STATUS(Enabled)
CEDF(No)
DATALOCATION(Below)
EXECKEY(CICS)
EXECUTIONSET(Fullapi)
CONCURRENCY(Quasirent)
```

It is recommended that you write your global user exit programs to be threadsafe. However, the system-autoinstalled program definition specifies CONCURRENCY(Quasirent); that is, the exit programs are defined as quasi-reentrant. To define a first-phase PLT global user exit program as threadsafe, specify the THREADSAFE keyword on the EXEC CICS ENABLE command. This overrides the CONCURRENCY(QUASIRENT) setting on the system-autoinstalled program definition.

- You cannot use Debug Tool to debug a first-phase PLT program.

## Second phase PLT programs

During the final stages of CICS initialization, most CICS services are available to PLT programs. These programs are specified in the second part of the PLTPI list (after the DFHDELIM entry). The limitations on the services that are available to second phase PLTPI programs are described below.

- Because interregion communication (IRC) and intersystem communication (ISC) have pseudo-terminal entries associated with their function, you cannot run any IRC or ISC functions during PLTPI processing.

**Note:** In this instance, “ISC”, means both intersystem communication over SNA (ISC over SNA) and IP interconnectivity (IPIC).

In other words, second phase PLT programs must not issue any EXEC CICS commands even INQUIRE commands, related to transaction routing (and therefore pseudo-terminals) that attempt to access remote resources.

This restriction occurs if the remote resource is not available. The remote resource might be unavailable for one of the following reasons:

- AUTOCONNECT=NO has been specified on the connection definition.
- The remote region is not running.
- The remote resource in the remote region is not available.
- The link is broken; because of a network problem, for example.

However, if the connection with the remote region is available and the resource in the remote region is also available, this restriction does not apply.



**Note:** A pseudo-terminal:

- Must be a surrogate TCTTE that exists only in an AOR
  - Can be used only in a transaction routing environment
  - Cannot exist with distributed program link (DPL) requests
  - Cannot exist with any type of function shipping request
  - Cannot exist in a distributed transaction.
- PLTPI programs can request services that could suspend the issuing task, but note that this affects the time at which control is given to CICS. The SUSPEND must not require the decision to resume to be taken by another task.
  - Although PLTPI programs can issue interval control START commands, the requested transactions are not attached before the initialization stages have completed, unless the ATTACH option is specified. START ATTACH allows a START command issued in a PLTPI program to take effect before initialization has completed. If you use START without the ATTACH option, the transaction invoked does not start until after the PLTPI programs have completed.
  - PLTPI programs must not issue dump requests.
  - PLTPI programs must not use the EXEC CICS PERFORM SHUTDOWN command, or a severe error will occur in DFHDMDM. The EXEC CICS PERFORM SHUTDOWN IMMEDIATE command is allowed.
  - Second stage initialization and second stage quiesce PLT programs do not require program resource definitions. If they are not defined, they are system autoinstalled (irrespective of the program autoinstall system initialization parameters). This means that the autoinstall exit is not called to allow the definition to be modified. The programs are defined with the following attributes:

```
LANGUAGE(ASSEMBLER)
STATUS(ENABLED)
CEDF(NO)
DATALOCATION(BELOW)
EXECCKEY(CICS)
EXECUTIONSET(FULLAPI)
```

As a result, system autoinstalled programs have a default CONCURRENCY setting of QUASIRENT, and a default API setting of CICSAPI.

- For those threadsafe PLT programs that
  - are defined with the OPENAPI value for the API attribute, or
  - are C or C++ programs compiled with the XPLINK compiler option

provide an appropriate resource definition, or alternatively, for Language Environment conforming programs, use the CICSVAR runtime option to set the appropriate CONCURRENCY and API values. See Defining runtime options for Language Environment, in the *CICS Application Programming Guide*.

- You cannot use Debug Tool to debug a second phase PLT program.

## Effect of delayed recovery on PLTPI processing

Because recovery processing does not take place until PLTPI processing is complete, PLT programs may fail during an emergency restart if they attempt to access resources protected by retained locks. If PLT programs are not written to handle the LOCKED exception condition, they abend with an AEX8 abend code.

If successful completion of PLTPI processing is essential before your CICS applications are allowed to start, consider alternative methods of completing necessary PLT processing. You may have to allow emergency restart recovery processing to finish, and then complete the failed PLTPI processing when the locks have been released.

---

## Writing shutdown programs

Any program that is to execute during CICS shutdown must be defined in a program list table (PLT), and the PLT must be named on the program list table shutdown (PLTSD) system initialization parameter. You can override the PLTSD value by providing a PLT name on the CEMT PERFORM SHUTDOWN command, or on the EXEC CICS PERFORM SHUTDOWN command. If a PLTSD program abends, syncpoint rollback occurs.

### First phase PLT programs

Programs that are to execute during the first quiesce stage of CICS shutdown are specified in the first half of the PLT (before the DFHDELIM statement).

You must define first stage PLTSD programs to CICS. You can either define the programs statically, or use program autoinstall.

Although terminals are still available during the first quiesce stage, tasks that are started by terminal input are rejected unless they are named in a shutdown transaction list table (XLT), or are CICS-supplied transactions, such as CEMT, CSAC, CSTE, and CSNE, that are defined as SHUTDOWN(ENABLED) in the supplied definitions.

The first quiesce stage is complete when all of the first-stage PLT programs have executed, and when there are no user tasks in the system.

You cannot use Debug Tool to debug a PLT program during the first quiesce stage.

### PLT programs for the second quiesce stage

Programs that are to execute during the second quiesce stage of CICS shutdown are specified in the second half of the PLT (after the DFHDELIM statement).

Second stage initialization and second stage quiesce PLT programs do not require program resource definitions. If they are not defined, they are system autoinstalled (irrespective of the program autoinstall system initialization parameters). This means that the autoinstall exit is not called to allow the definition to be modified. The programs are defined with the following attributes:

```
LANGUAGE(ASSEMBLER) STATUS(ENABLED) CEDF(NO)
DATALOCATION(BELOW) EXECKEY(CICS)
EXECUTIONSET(FULLAPI)
```

As a result, system autoinstalled programs have a default CONCURRENCY setting of QUASIRENT, and a default API setting of CICSAPI.

- For those threadsafe PLT programs that
  - are defined with the OPENAPI value for the API attribute, or
  - are C or C++ programs compiled with the XPLINK compiler option

provide an appropriate resource definition, or alternatively, for Language Environment conforming programs, use the CICSVAR runtime option to set the appropriate CONCURRENCY and API values. See Defining runtime options for Language Environment, in the *CICS Application Programming Guide*.

During the second quiesce stage, no new tasks can start, and no terminals are available. Because of this, second phase PLT programs must not cause other tasks

to be started, and they cannot communicate with terminals. Further, second phase PLT programs must not cause any resource security checking or DB2 calls to be performed.

If a transaction abend occurs while the PLTSD program is running, CICS is left in a permanent wait state. To avoid this happening, ensure that your PLTSD program handles **all** abend conditions.

The second quiesce stage is complete when all of the second phase PLT programs have been executed.

You cannot use Debug Tool to debug a PLT program during the second quiesce stage.

## The shutdown assist utility program, DFHCESD

CICS provides a shutdown assist transaction, that can be run during the first quiesce stage of shutdown. It can be run on a normal or an immediate shutdown.

You specify the name of the shutdown transaction on the **SDTRAN** system initialization parameter, or on the SDTRAN option of the PERFORM SHUTDOWN and PERFORM SHUTDOWN IMMEDIATE commands. You can also specify that no shutdown assist transaction is to be run. If you do specify that no shutdown assist transaction is to be run:

- On a normal shutdown, CICS waits for all running tasks to finish before entering the second stage of quiesce. Long running or conversational transactions can cause an unacceptable delay or require operator intervention.
- On an immediate shutdown, CICS does not allow running tasks to finish and backout is not performed until emergency restart. This can cause an unacceptable number of units of work to be shunted, and locks to be retained unnecessarily.

The purpose of the shutdown assist transaction is to help solve these problems; that is, to ensure that as many tasks as possible commit or back out cleanly within a reasonable time.

The default shutdown assist transaction is CESD, which starts the CICS-supplied program DFHCESD. DFHCESD attempts to purge and back out long-running tasks using increasingly stronger techniques. It ensures that as many tasks as possible commit or back out cleanly, enabling CICS to shut down in a controlled manner. For information about DFHCESD, and about how to write your own shutdown assist transaction, see the *CICS Operations and Utilities Guide*.

---

## General considerations when writing initialization and shutdown programs

- It is recommended that you terminate all PLT programs with an EXEC CICS RETURN command.
- PLT programs receive control in primary-space translation mode. For information about translation modes, see the *IBM ESA/390 Principles of Operation* manual. They must return control to CICS in the same mode, and must restore any general purpose registers or access registers that they use.
- All PLTPI programs run under the CICS internal transaction name CPLT. Therefore, because CICS internal transactions are defined with the WAIT indoubt attribute set to 'YES', an in-doubt failure that occurs while running a PLTPI

program causes the relevant unit of work to be shunted. The PLTPI program abends ASP1, and CICS runs the next program defined in the PLTPI table, if any.

- PLTSD programs run under the transaction that issued the PERFORM SHUTDOWN command. The CEMT transaction is defined with WAIT(YES). Therefore, if shutdown is as the result of a CEMT PERFORM SHUTDOWN command, an in-doubt failure that occurs while running a PLTSD program causes the unit of work to be shunted. If, however, shutdown is as the result of a user transaction issuing an EXEC CICS PERFORM SHUTDOWN command, whether an in-doubt failure causes the unit of work to be shunted or a forced decision taken depends on the indoubt attributes of the user transaction. For details of the indoubt options of the CEDA DEFINE TRANSACTION command, see the *CICS Resource Definition Guide*.

## Storage keys for PLT programs

You need to consider the following (whether or not you are running CICS with the storage protection facility):

- The execution key in which your PLT programs are invoked
- The storage key of data storage obtained for your PLT programs.

### Execution key for PLT programs

At PLT time CICS handles Java and non-Java programs differently.

### Non-Java Programs

CICS always gives control to PLT programs in CICS key. Even if you specify EXECKEY(USER) on the program resource definition, CICS forces CICS key when it passes control to any PLT programs invoked during initialization or shutdown. However, if a PLT-defined *shutdown* program itself passes control to another program (via a link or transfer-control command), the program thus invoked executes according to the execution key (EXECKEY) defined in its program resource definition.

### Important

You are strongly recommended to specify EXECKEY(CICS) when defining both PLT programs and programs to which a PLT program passes control.

### Java Programs

A Java program in the PLT runs in the key defined in its PROGRAM resource definition (EXECKEY) and is not overridden to run in CICS key, unlike all other program types.

When a Java program runs, a JVM is created if one does not already exist for that JVM profile in the key the program is running. If REUSE=YES is specified in the corresponding JVM profile, the JVM persists after the Java program has ended. If a Java program, that is defined as EXECKEY(USER), was overridden to start in CICS key at PLT time, any subsequent calls of that program would run in USER key and would therefore not be able to reuse the JVM created when the program ran at PLT time. Other Java programs that are defined with EXECKEY(USER) and use the same JVM Profile would also not be able to access the JVM that is started at PLT time. Therefore, CICS does not override the execution key of Java programs at PLT time. To run an EXECKEY(USER) Java program in CICS key at PLT time do the following:

1. Create a separate PROGRAM resource definition using the same JVMCLASS attribute value and specify EXECKEY(CICS).
2. Add the PROGRAM resource definition to the PLT.

The original PROGRAM resource definition with EXECKEY(USER) can then be used subsequently.

## Data storage key for PLT programs

The storage key of storage used by PLT programs depends on how the storage is obtained:

- Any working storage requested by the PLT program is in the key set by the TASKDATAKEY of the transaction under which the PLT program is invoked. In the case of those PLT programs that run during initialization (PLTPI programs), the transaction is always an internal CICS transaction, in which case the TASKDATAKEY is always CICS. In the case of those programs that run during shutdown (PLTSD programs), it depends on the transaction you use to issue the shutdown command. If you issue a CEMT PERFORM SHUTDOWN command, the TASKDATAKEY is always CICS. If you run a user-defined transaction, to invoke a program that issues an EXEC CICS PERFORM SHUTDOWN command, the TASKDATAKEY can be either USER or CICS.
- PLT programs can use EXEC CICS commands to obtain storage by issuing:
  - Explicit EXEC CICS GETMAIN commands
  - Implicit storage requests as a result of EXEC CICS commands that use the SET option.

The default storage key for storage obtained by EXEC CICS commands is set by the TASKDATAKEY of the transaction under which the PLT program is invoked, exactly as described for working storage.

As an example, consider a transaction defined with TASKDATAKEY(USER) that causes a PLT shutdown program to be invoked. In this case, any implicit or explicit storage acquired by the PLT program by means of an EXEC CICS command is, by default, in user-key storage. However, on an EXEC CICS GETMAIN command, the PLT program can override the TASKDATAKEY option by specifying either CICS DATAKEY or USER DATAKEY.



---

## Part 3. Customizing with user-replaceable programs





---

## Chapter 5. General notes about user-replaceable programs

The comments in this chapter apply to all the user-replaceable programs described in Part 3 of this book. The chapter is divided into the following sections:

1. “Rewriting user-replaceable programs”
2. “Assembling and link-editing user-replaceable programs” on page 436
3. “User-replaceable programs and the storage protection facility” on page 437.

---

### Rewriting user-replaceable programs

A user-replaceable program is a CICS-supplied program that is always invoked at a particular point in CICS processing, as if it were part of the CICS code. You can modify the supplied program by including your own logic, or replace it with a version that you write yourself.

There are some general considerations that you must bear in mind when creating your own versions of user-replaceable programs:

- User-replaceable programs are all command-level programs (not user exits).
- You can code user-replaceable programs in any of the languages supported by CICS (that is, in assembler language, COBOL, PL/I, or C). An assembler-language version of most programs is provided, in source form, in the CICSTS32.CICS.SDFHSAMP library. COBOL, PL/I, or C versions are provided for some programs. The relevant chapter lists the sample programs, copy books, and macros supplied in each case.
- You can trap an abend in a user-replaceable program by making the program issue an EXEC CICS HANDLE ABEND command. However, if no HANDLE ABEND is issued, CICS does not abend the task but returns control to the CICS module that called the program. The action taken by the CICS module depends on the user-replaceable program concerned.
- Upon return from any user-replaceable program, CICS must always receive control in primary-space translation mode, with the original contents of all access registers restored, and with all general purpose registers restored (except for those which provide return codes or linkage information).

For information about translation modes, refer to the *IBM ESA/370 Principles of Operation* manual.

- User-replaceable programs, and any programs invoked by user-replaceable programs, can be RMODE ANY but **must** be AMODE 31.
- You must ensure that user-replaceable programs are defined as local. User-replaceable programs cannot be run in a remote region. This applies to all user-replaceable programs, including the autoinstall control program and the dynamic routing program.
- User-replaceable programs produce only system dumps when a program check occurs; they do not produce transaction dumps.
- You can use the CICS Execution Diagnostic Facility (EDF) to test user-replaceable programs. However, EDF does not work if the initial transaction is a CICS-supplied transaction.

---

## Assembling and link-editing user-replaceable programs

The source for the CICS-supplied user-replaceable programs is installed in the CICSTS32.CICS.SDFHSAMP library. If you intend changing any of these programs, take a copy of the CICSTS32.CICS.SDFHSAMP library and update the copy only. If the original SDFHSAMP is serviced, and a user-replaceable program is modified, you may like to reflect the changes in your own version of the code.

To replace one of these CICS-supplied programs, assemble and link-edit your version of the program. Except for DFHJVMRO and DFHAPXPO, all programs are supplied as command-level programs, and must be translated before assembly and link-edit. Note that the translator options NOPROLOG and NOEPILOG should be coded with your versions of DFHZNEP, DFHTEP, and DFHXCURM.

If you have user-written versions of DFHZNEP, DFHPEP, or DFHTEP from an earlier release of CICS, and they use macros, recode the programs to use EXEC CICS commands.

To translate, assemble, and link-edit user-replaceable programs, you can use the CICS-supplied procedure DFHEITAL. For information about using DFHEITAL, see Using the CICS-supplied procedures to install application programs, in the *CICS Application Programming Guide*. If you use SMP/E, you can give the object-deck output after translation and assembly to SMP/E for link-editing.

With the exception of DFHJVMRO and DFHAPXPO, when link-editing a user-replaceable program you must link-edit it with the EXEC interface module (stub). This stub enables the program to communicate with the EXEC interface program (DFHEIP). If you use the DFHEITAL procedure, it link-edits programs with the EXEC interface stub by default.

DFHJVMRO and DFHAPXPO should not be translated and do not need to be link-edited with the EXEC interface module. You can use the DFHASMVS procedure to compile these programs.

The job stream in Figure 16 is an example of the assembly and link-edit of a user-replaceable program. The figure is followed by some explanatory notes.

```
//ASSEMBLE EXEC DFHEITAL,
//  ASMBLR=ASMA90,
//  INDEX='CICSTS31.CICS',           1
//  PROGLIB='your_loadlib',         2
//  DSCTLIB='your_copylib',        3
//  PARM.TRN='NOPROLOG,NOEPILOG',   4
//  PARM.ASM='DECK,NOOBJECT,LIST,XREF(SHORT),RENT,ALIGN',
//  LNKPARM='LIST,XREF,RENT,MAP,AMODE(31),RMODE(ANY)'
//TRN.SYSIN DD DSN=your_source1ib(program_name),DISP=SHR 5 6
//LKED.SYSIN DD *
  ENTRY program_name                7
  NAME program_name(R)
//*
```

Figure 16. Job stream to assemble and link-edit a user-replaceable program

Notes:

1 High-level qualifier of the CICS libraries.

- 2 The library into which the load module will be link-edited.
- 3 Optionally, the name of a library containing your local Assembler macros and copy members.
- 4 These options are required for DFHXCURM, and for the supplied sample versions of DFHTEP and DFHZNEP.
- 5 `your_source lib` is the name of the library containing your modified version of the program.
- 6 `program_name` is the source member name of the user-replaceable program being assembled. The source member for the supplied DFHTEP sample is DFHXTEP. The source member for the supplied DFHZNEP sample is DFHZNEP0. The Assembler source member for the supplied DFHEJDNX sample is DFHEJDN1.
- 7 The input to the linkage-editor normally consists of the two statements shown here, with `program_name` replaced by the name of the user-replaceable program being compiled. There are some exceptions for some of the CICS-supplied sample programs, and these are shown in Figure 17.

Figure 17. Link-edit statements for DFHTEP and DFHZNEP

Link-edit statements for DFHTEP:

```
ENTRY DFHTEPNA
NAME DFHTEP(R)
```

Link-edit statements for DFHZNEP:

```
ENTRY DFHZNENA
NAME DFHZNEP(R)
```

---

## User-replaceable programs and the storage protection facility

When you are running CICS with the storage protection facility, there are two points you need to consider:

- The execution key in which your user-replaceable programs run
- The storage key of data storage obtained for your user-replaceable programs.

### Execution key for user-replaceable programs

When you are running with storage protection active, CICS always gives control to user-replaceable programs in CICS key. Even if you specify EXECKEY(USER) on the program resource definition, CICS forces CICS key when it invokes the program. However, if a user-replaceable program itself passes control to another program, the program thus invoked executes according to the execution key (EXECKEY) defined in its program resource definition.

#### Important

You are strongly recommended to specify EXECKEY(CICS) when defining both user-replaceable programs and programs to which a user-replaceable program passes control.

## Data storage key for user-replaceable programs

The storage key of storage used by user-replaceable programs depends on how the storage is obtained:

- The communication area passed to the user-replaceable program by its caller is always in CICS key.
- Any working storage obtained for the user-replaceable program is in the key set by the TASKDATAKEY of the transaction under which the program is invoked.
- User-replaceable programs can use EXEC CICS commands to obtain storage, by issuing:
  - Explicit EXEC CICS GETMAIN commands
  - Implicit storage requests as a result of EXEC CICS commands that use the SET option.

The default storage key for storage obtained by EXEC CICS commands is set by the TASKDATAKEY of the transaction under which the user program is invoked.

As an example, consider a transaction defined with TASKDATAKEY(USER) that causes a user-replaceable program to be invoked. In this case, any implicit or explicit storage acquired by the user program by means of an EXEC CICS command is, by default, in user-key storage. However, on an EXEC CICS GETMAIN command, the user program can override the TASKDATAKEY option by specifying either CICSDATAKEY or USERDATAKEY.

---

## Chapter 6. Writing a program error program

### Considerations common to all user-replaceable programs

Note that the comments contained in Chapter 5, “General notes about user-replaceable programs,” on page 435 apply to this chapter.

The CICS-supplied default program error program (DFHPEP) contains code to:

- Obtain program addressability
- Access the communication area
- Return control to CICS through an EXEC CICS RETURN command.

The source of DFHPEP is provided in assembler-language and C versions; you can modify one of these to include your own logic, or you can write your own program error program in any of the languages supported by CICS. There is a discussion of the reasons for using your own program error program in the *CICS Recovery and Restart Guide*. Note, however, that when writing a program error program you are subject to specific restrictions:

- Your program must be named DFHPEP.
- It must not issue any EXEC CICS commands that make use of MRO or ISC facilities (such as distributed transaction processing or function shipping).
- It must not issue any commands that access recoverable resources.
- It cannot influence the taking of a transaction dump.

The default DFHPEP module is a dummy module. If you want to customize it, you have to code the source yourself. To help you, a listing of DFHPEP is provided in Figure 18 on page 441. When you have written your program error program, translate and assemble it, and use it to replace the supplied dummy program. For information about the job control statements necessary to assemble and link-edit user-replaceable programs, refer to “Assembling and link-editing user-replaceable programs” on page 436.

Information available to DFHPEP in the communication area includes:

- The current abend code, at PEP\_COM\_CURRENT\_ABEND\_CODE.
- The original abend code, at PEP\_COM\_ORIGINAL\_ABEND\_CODE. The “original” and “current” abend codes are different if the transaction has suffered more than one abend—for example, if the failing program abended while handling a previous abend. In this case, the “original” abend is the first abend that the transaction suffered.
- The EIB at the time of the last EXEC CICS command, at PEP\_COM\_USERS\_EIB.
- The name of the program that suffered the (current) abend, at PEP\_COM\_ABPROGRAM. PEP\_COM\_ABPROGRAM identifies the program as follows:
  - If the abend occurred in a distributed program link (DPL) server program running in a remote system, it identifies the server program.
  - If the abend is a local ‘ASRA’, ‘ASRB’, or ‘ASRD’, it identifies the program in which the program check or operating system abend occurred.
  - In all other cases, it identifies the current PPT entry.

- The program status word (PSW) at the time of the (current) abend, at PEP\_COM\_PSW. The full contents of PEP\_COM\_PSW are significant for abend codes 'ASRA', 'ASRB', and 'ASRD' only; the last four characters (the PSW address) apply also to code 'AICA'.
- The GP registers (0-15) at the time of the (current) abend, at PEP\_COM\_REGISTERS.
- The execution key of the program at the time it suffered the (current) abend, at PEP\_COM\_KEY. The value of PEP\_COM\_KEY is significant for abend codes 'ASRA' and 'ASRB' only.
- Whether the (current) abend occurred as the result of a storage protection exception, at PEP\_COM\_STORAGE\_HIT. The value of PEP\_COM\_STORAGE\_HIT is significant for abend code 'ASRA' only, and indicates which of the protected dynamic storage areas (the CDSA, ECDSA, or ERDSA), if any, the failing program attempted to overwrite.
- The address of the task abend control block (TACB). This provides details of the subspace and access registers current at the time of the abend. The subspace value is in PEP\_COM\_SPACE.
- Program status word interrupt information, at PEP\_COM\_INT.

Note that information about the PSW, registers, execution key, and type of storage "hit" is meaningful only if the abend occurred in the local system; these fields are set to zeros if the abend occurred in a DPL server program running in a remote system.

In order to disable the transaction, you should assign the value 'PEP\_COM\_RETURN\_DISABLE' to the field PEP\_COM\_RETURN\_CODE. Otherwise, you should allow the field to default to zero, or set it to the value 'PEP\_COM\_RETURN\_OK'. CICS does not allow CICS-supplied transactions to be disabled; you should not, therefore, attempt to disable transactions whose IDs begin with "C".

The assembler-language source code of the default program error program is shown in Figure 18 on page 441. The communication area is shown in Figure 19 on page 442.

```

DFHEISTG DSECT ,
*
*      Insert your own storage definitions here
*
      DFHPCOM TYPE=DSECT
*****
* * * * *          P R O G R A M   E R R O R          * * * * *
* * * * *          P R O G R A M                   * * * * *
*****
DFHPEP  CSECT          PROGRAM ERROR PROGRAM CSECT
DFHPEP  RMODE ANY
DFHPEP  DFHREGS ,          EQUATE REGISTERS
        XR    R1,R1
        ICM  R1,B'0011',EIBCALEN Get Commarea length
        BZ   RETURNX      ...no Commarea; exit
        EXEC CICS ADDRESS COMMAREA(R2) ,
        USING DFHPEP_COMMAREA,R2
*
*      Insert your own code here
*
        LA   R1,PEP_COM_RETURN_OK
        B    RETURN
        DFHEJECT
*
RETURNER DS    0H          Return for error cases
        LA   R1,PEP_COM_RETURN_DISABLE
RETURN   DS    0H
        ST   R1,PEP_COM_RETURN_CODE
RETURNX  DS    0H
        EXEC CICS RETURN ,
        END  DFHPEP

```

Figure 18. Source code of the default program error program (DFHPEP)

```

DFHPEP_COMMAREA DSECT
*
*           Standard header section
*
PEP_COM_STANDARD          DS    0F
PEP_COM_FUNCTION          DS    CL1      Always '1'
PEP_COM_COMPONENT        DS    CL2      Always 'PC'
PEP_COM_RESERVED         DS    C        Reserved
*
*           Abend codes and EIB
*
PEP_COM_CURRENT_ABEND_CODE DS    CL4      Current abend code
PEP_COM_ORIGINAL_ABEND_CODE DS    CL4      Original abend code
PEP_COM_USERS_EIB        DS    CL(EIBRLDBK-EIBTIME+L'EIBRLDBK)
*                               EIB at last EXEC CICS command
*
* Debugging information (program, PSW, registers and execution key at
* time of abend, hit storage indicator). If the abend occurred in a
* DPL server program running remotely, only program is meaningful.
*
PEP_COM_DEBUG            DS    0F
PEP_COM_ABPROGRAM        DS    CL8      Program causing abend
PEP_COM_PSW              DS    CL8      PSW at abend
*                               (codes ASRA, ASRB, AICA, ASRD)

PEP_COM_REGISTERS        DS    CL64     GP registers at abend
*                               (registers 0-15)
PEP_COM_KEY              DS    X        Execution key at abend
*                               (ASRA and ASRB only)
PEP_COM_USER_KEY         EQU    9      User key
PEP_COM_CICS_KEY         EQU    8      CICS key
*
PEP_COM_STORAGE_HIT      DS    X        Storage type hit by 0C4
*                               (ASRA only)
PEP_COM_NO_HIT           EQU    0      No hit, or not 0C4
PEP_COM_CDSA_HIT         EQU    1      CDSA hit
PEP_COM_ECDSA_HIT        EQU    2      ECDSA hit
PEP_COM_ERDSA_HIT        EQU    3      ERDSA hit
PEP_COM_RDSA_HIT         EQU    4      RDSA hit
PEP_COM_EUDSA_HIT        EQU    5      EUDSA hit
PEP_COM_UDSA_HIT         EQU    6      EUDSA hit
*
PEP_COM_SPACE            DS    X        Subspace/basespace
PEP_COM_NOSPACE          EQU    0
PEP_COM_SUBSPACE         EQU    10     Abending task was in
*                               subspace
PEP_COM_BASESPACE        EQU    11     Abending task was in
*                               basespace
PEP_COM_PADDING          DS    CL2     Reserved
*
*           Return code
*
PEP_COM_RETURN_CODE      DS    F
PEP_COM_RETURN_OK        EQU    0
PEP_COM_RETURN_DISABLE   EQU    4      Disable transaction
*
*           Additional Program status word information
*
PEP_COM_INT              DS    CL8     PSW interrupt codes
*
*                               length of DFHPEP_COMMAREA
PEP_COM_LEN EQU *-PEP_COM_STANDARD

```

Figure 19. Source of DFHPEP communication area (assembler-language)



---

## The sample program error programs

Two source-level versions of the default program are provided: DFHPEP, coded in assembler language, and DFHPEPD, coded in C. Both are in the CICSTS32.CICS.SDFHSAMP library. There is an assembler-language macro, DFHPCOM, and a corresponding C copy book, DFHPCOMD, that you can use to define the communication area. These are found in the CICSTS32.CICS.SDFHMAC and CICSTS32.CICS.SDFHC370 libraries, respectively.

You can code your program error program in any of the languages supported by CICS, but you must always name it DFHPEP.



---

## Chapter 7. Writing a transaction restart program

The transaction restart user-replaceable program (DFHREST) enables you to participate in the decision as to whether a transaction should be restarted or not.

CICS invokes DFHREST when a transaction abends, if RESTART(YES) is specified in the transaction's resource definition (the default is RESTART(NO)).

The default program requests restart under certain conditions; for example, in the event of a program isolation deadlock (that is, when two tasks each wait for the other to release a particular DL/I database segment or file record), one of the tasks is backed out and automatically restarted, and the other is allowed to complete its update.

For general information about restarting transactions, see the *CICS Recovery and Restart Guide*.

### Note:

1. If your transaction restart program chooses to restart a transaction, a new task is attached that invokes the initial program of the transaction. This is true even if the task abended in the second or subsequent UOW, and DFHREST requested a restart.
2. Statistics on the total number of restarts against each transaction are kept.
3. Emergency restart does not restart any tasks.
4. In some cases, the benefits of transaction restart can be obtained instead by using the SYNCPOINT ROLLBACK command. Although use of the ROLLBACK command is not usually recommended, it does keep all the executable code in the application programs.

When planning to replace the default DFHREST, check to see if the logic of any of your transactions is inappropriate for restart.

- Transactions that execute as a single unit of work are safe. Those that execute a loop, and on each pass reading one record from a recoverable destination, updating other recoverable resources, and closing with a syncpoint, are also safe.
- There are two types of transaction that need to be modified to avoid erroneously repeating work done in the units of work that precede an abend:
  1. A transaction in which the first and subsequent units of work change different resources
  2. A transaction where the contents of the input data area are used in several units of work.
- Distributed transactions whose principal facilities are APPC links should not be considered for transaction restart. Restarting a back-end or front-end transaction while the other side of the conversation is still active presents problems with correct error handling and recovery of the conversation state.

All the following conditions must be true for CICS to invoke the transaction restart program:

- A transaction must be terminating abnormally.

- The transaction abend which caused the transaction to be terminating abnormally must have been detected before the commit point of the implicit syncpoint at the end of the transaction has been reached.
- The transaction must be defined as restartable in its transaction definition.
- The transaction must be related to a principal facility.

If these conditions are satisfied, CICS invokes the transaction restart program, which then decides whether or not to request that the transaction be restarted. CICS can subsequently override the decision (for example, if dynamic backout fails). Also, if the transaction restart program abends, the transaction is not restarted.

If the above conditions are not satisfied, CICS does not invoke the transaction restart program and the transaction is not restarted.

---

## The DFHREST communications area

The CICS-supplied default transaction restart program is written in assembler and contains logic to:

- Address the communications area passed to it by CICS
- Decide whether or not to request transaction restart
- Send a message to CSMT if restart is requested
- Return control to CICS using the EXEC CICS RETURN command.

The communications area is mapped by the XMRS\_COMMAREA DSECT, which is supplied in the DFHXMRS copybook. The equivalent structures for C, COBOL, and PL/1 are contained in the copybooks DFHXMRSRSH, DFHXMRSO, and DFHXMRSRSP, respectively.

The information passed in the communications area is as follows:

### **XMRS\_FUNCTION**

Indicates, in a 1-byte field, the function code for this call to the restart program. This is always set to 1, which equates to XMRS\_TRANSACTION\_RESTART, which means that DFHREST is called to handle transaction restart.

### **XMRS\_COMPONENT\_CODE**

Indicates, in a 2-byte field, the component code of the caller. This is always set to XM, which equates to XMRS\_TRANSACTION\_MANAGER. The transaction manager is the CICS component that coordinates the decision whether or not to restart a transaction.

### **XMRS\_READ**

Indicates, in a 1-byte field, whether the transaction has issued any terminal read requests, other than for initial input.

The equated values for this parameter are:

#### **XMRS\_READ\_YES**

Means a terminal read has been performed by the transaction.

#### **XMRS\_READ\_NO**

Means no terminal read has been performed.

### **XMRS\_WRITE**

Indicates, in a 1-byte field, whether the transaction has issued any terminal write requests.

The equated values for this parameter are:

**XMRS\_WRITE\_YES**

Means a terminal write has been performed by the transaction.

**XMRS\_WRITE\_NO**

Means a terminal write has not been performed by the transaction.

**XMRS\_SYNCPOINT**

Indicates, in a 1-byte field, whether the transaction has performed any syncpoints.

The equated values for this parameter are:

**XMRS\_SYNCPOINT\_YES**

Means one or more syncpoints have been performed.

**XMRS\_SYNCPOINT\_NO**

Means no syncpoints have been performed.

**XMRS\_RESTART\_COUNT**

This indicates, as an unsigned, half-word binary value, the number of times the transaction has been restarted.

It is zero if the transaction has not been restarted. It is **not** the total number of restarts for the transaction definition. Rather it is the total number of restarts for transactions that are attempting, for example, to process a single piece of operator input.

**XMRS\_ORIGINAL\_ABEND\_CODE**

Provides the first abend code recorded by the transaction.

**XMRS\_CURRENT\_ABEND\_CODE**

Provides the current abend code. The values of the original abend code and the current abend code can be different if, for example, a transaction handles an abend and then abends later.

**XMRS\_RESTART**

This is a 1-byte output field that the transaction restart program sets to indicate whether it wants CICS to restart the transaction.

The equated values for this field are:

**XMRS\_RESTART\_YES**

Requests a restart.

**XMRS\_RESTART\_NO**

Requests no restart.

---

## The CICS-supplied transaction restart program

The CICS-supplied default transaction restart program requests that the transaction be restarted if:

1. The transaction has not performed a terminal read (other than reading the initial input data), terminal write or syncpoint, **and**
2. The restart count is less than 20 (to limit the number of restarts), **and**
3. The current abend code is one of the following:
  - ADCD, indicating that the transaction abended due to a DBCTL deadlock
  - AFCF, indicating that the transaction abended due to a file control-detected deadlock

- AFCW, indicating that the transaction abended due to a VSAM-detected deadlock (RLS only).

The source of the CICS-supplied default transaction restart program, DFHREST, is supplied in assembler language only, in the CICSTS32.CICS.SDFHSAMP library.

The assembler copybook for mapping the communications area is in the CICSTS32.CICS.SDFHMAC library.

---

## Chapter 8. Writing a terminal error program

### Considerations common to all user-replaceable programs

Note that the comments contained in Chapter 5, “General notes about user-replaceable programs,” on page 435 apply to this chapter.

This chapter contains information about the CICS terminal error program (TEP), which handles error conditions for devices that use the sequential access method.

**Note that node error programs, not terminal error programs, must be used for VTAM-supported devices.** The chapter is divided into three sections:

1. “Background to error handling for sequential devices” is an overview.
2. “The sample terminal error program” on page 451 describes the CICS-supplied sample TEP. It contains:
  - “Components of the sample terminal error program” on page 451
  - “Structure of the sample terminal error program” on page 453
  - “Sample terminal error program messages” on page 456
  - “Generating the sample terminal error program” on page 458.
3. “Writing your own terminal error program” on page 470 discusses factors you need to consider when writing your own terminal error program. It contains:
  - “Why write your own terminal error program?” on page 470
  - “Restrictions on the use of EXEC CICS commands” on page 470
  - “Addressing the contents of the communication area” on page 471
  - “Addressing the contents of the TACLE” on page 473
  - “Example of a user-written terminal error program” on page 475.

---

### Background to error handling for sequential devices

CICS terminal error handling is based on the assumption that most users want to modify CICS operations in response to terminal errors. Because CICS cannot anticipate all possible courses of action, the error-handling facilities have been designed to allow maximum freedom for users to create unique solutions for errors that occur within a terminal network.

The following CICS components are involved in the detection and correction of errors that occur when sequential devices are used:

- Terminal control program (DFHTCP)
- Terminal abnormal condition program (DFHTACP)
- Terminal error program (DFHTEP).

These components are discussed in the following sections. (The corresponding CICS components for logical units are discussed in Chapter 9, “Writing a node error program,” on page 479.)

### When an abnormal condition occurs

When an abnormal condition associated with a particular terminal or line occurs, the terminal control program puts the terminal out of service and passes control to the terminal abnormal condition program (DFHTACP) which, in turn, passes control to a

version of the terminal error program (DFHTEP, either CICS-supplied or user-written), so that it can take the appropriate action.

## Terminal control program

When the terminal from which the error was detected has been put out of service, the terminal control program creates a terminal abnormal condition line entry (TACLE), which is chained off the real entry, the terminal control table line entry (TCTLE) for the line on which the error occurred. The TACLE contains information about the error.

## Terminal abnormal condition program

After the TACLE has been established, a task that executes DFHTACP is attached by the terminal control program and is provided with a pointer to the real line entry (TCTLE) on which the error occurred. After performing basic error analysis and establishing the default actions to be taken, DFHTACP gives control to DFHTEP, and passes a communication area (DFHTEPCA) so that DFHTEP can examine the error and provide an alternative course of action.

The communication area provides access to all the error information necessary for correct evaluation of the error; and contains special action flags that can be manipulated to alter the default actions previously set by DFHTACP.

After DFHTEP has performed the desired function, it returns control to DFHTACP by issuing an EXEC CICS RETURN command. DFHTACP then performs the actions dictated by the action flags within the communication area, and the error-handling task terminates.

**Note:** If DFHTACP has more than eight errors on a line before action can be taken, the line is put out of service to avoid system degradation.

## Terminal error program

The terminal error program analyzes the cause of the terminal or line error that has been detected by the terminal control program. The CICS-supplied version (the sample terminal error program, DFHXTEP) is designed to attempt basic and generalized recovery actions. A user-written version of this program can be provided to handle specific application-dependent recovery actions. The user-written terminal error program is linked-to in the same way as the CICS-supplied version, by the terminal abnormal condition program. Information relating to the error is carried in the communication area and the TACLE.

The macros that are provided for generating the sample terminal error program are described in the sections that follow. The main steps are generating the sample DFHTEP module and tables by means of the DFHTEPM and DFHTEPT macros, respectively. You can select the appropriate options in this sample program, and you can base your own version on it.

There is a description of the CICS-supplied sample terminal error program (DFHXTEP), and advice about how to generate a user-written version, later in this chapter.

**Note:** If DFHTEP abends, then the default actions specified in DFHTACP are reinstated.



## The communication area

The communication area is the basic interface used by the sample DFHTEP, and should be used by a user-written DFHTEP to:

- Address the TACLE
- Indicate the course of action to be taken on return to DFHTACP.

Before giving control to DFHTEP, DFHTACP establishes which default actions should be taken. This depends on the particular error condition that has been detected. The default actions are indicated by appropriate bit settings in the 1-byte communication area field TEPCAACT. For details about communication area fields, default actions, and bit settings, refer to “Writing your own terminal error program” on page 470.

## Terminal abnormal condition line entry (TACLE)

The TACLE contains further information about the type of error, and about the type of terminal that is in error.

The code indicating the detected error condition is passed to DFHTEP in the 1-byte field of the TACLE labeled TCTLEPFL. (These DFHTACP error codes, message codes, conditions, and default actions are also listed in the *CICS Problem Determination Guide*.)

A format description of the terminal abnormal condition line entry (TACLE) DSECT is provided under “Writing your own terminal error program” on page 470.

---

## The sample terminal error program

CICS provides a sample terminal error program that can be used as a generalized program structure for handling terminal errors. Note that, although the source code form of the sample TEP (DFHXTEP) is provided in assembler language only, you can write your own terminal error program in any of the languages supported by CICS.

After DFHXTEP has been assembled, it is link-edited as DFHTEP. For information about the job control statements necessary to assemble and link-edit user-replaceable programs, refer to “Assembling and link-editing user-replaceable programs” on page 436.

You can generate and use the sample terminal error program with the default options provided, or you can customize the terminal error support to the needs of the operating environment by selecting the appropriate generation options and variables. Because each error condition is processed by a separate routine, you can replace a CICS-provided routine with a user-written one when the sample TEP is generated.

## Components of the sample terminal error program

The sample terminal error program consists of the terminal error program itself and two terminal error program tables:

- The TEP error table
- The TEP default table.

Both tables contain “thresholds” defined for the various error conditions to be controlled and accounted for by the sample DFHTEP. A “threshold” may be thought

of as the number of error occurrences that are permitted for a given type of error on a given terminal before the sample DFHTEP accepts the DFHTACP default actions. Optionally, the number of occurrences can be controlled and accounted for over prescribed time intervals (for example, if more than three of a given type of error occur in an hour, the terminal is put out of service).

### TEP error table

The terminal error program (TEP) error table maintains information about errors that have occurred on a terminal. The table consists of two parts (shown in Figure 20):

- The TEP error table header (TETH), which contains addresses and constants related to the location and size of the TEP error table components.
- Terminal error blocks (TEBs), which can be either:
  - Permanent (P-TEBs), each associated with a particular terminal
  - Reusable (R-TEBs), not permanently associated with any particular terminal.

TEP error table header (TETH)
Terminal error blocks (P-TEBs and R-TEBs)

Figure 20. TEP error table

TEBs maintain error information associated with terminals. You must specify the total number of TEBs to be generated. The maximum number needed is one per terminal. In this case the TEBs are permanent.

You can reduce the total amount of storage used for TEBs by allocating a pool of reusable TEBs, that are not permanently associated with a particular terminal. Reusable TEBs are assigned dynamically on the first occurrence of an error associated with a terminal, and are released for reuse when the appropriate error processor places the terminal out of service.

**Note:** Ensure that the pool is large enough to hold the maximum number of terminals for which errors are expected to be outstanding at any one time. If the pool limit is exceeded, handling of terminal errors may become intermittent. **No warning is given of this condition.**

You should assign permanent TEBs to terminals that are critical to the network. For the remainder of the network, you can generate a pool of reusable TEBs.

Each TEB currently in use or permanently assigned contains the symbolic terminal identifier of the terminal, and one or more error status elements (ESEs), as shown in Figure 21 on page 453.

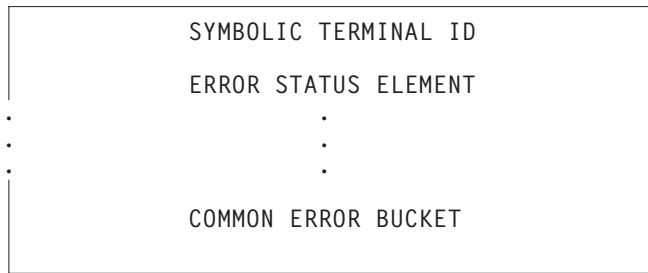

Figure 21. Terminal error block (TEB)

An ESE records the occurrence of a particular type of error associated with the terminal. The contents of an error status element are described in the TEPCD DSECT (generated by the DFHTEPM TYPE=INITIAL macro) under the comment “ERROR STATUS ELEMENT FORMAT”. The number of ESEs per TEB remains constant for all TEBs. You specify the number when the TEP tables are generated. If fewer than the maximum number of error types recognized by DFHTACP (25) are specified, one additional ESE, referred to as the “common error bucket”, is generated for each TEB.

You can permanently reserve ESE space in each TEB for specific error types. Those not permanently reserved are considered reusable, and are assigned dynamically on the first occurrence of a particular error type associated with the terminal. If an error type occurs that is not currently represented by an ESE, and if all reusable ESEs are assigned to other error types, the occurrence of this error is recorded in the common error bucket. DFHTACP can recognize far more error types than can occur in a typical terminal network. By specifying less than the maximum and allowing the sample DFHTEP to assign ESEs dynamically, you can minimize the table size, and still control and account for the types of errors relevant to the network.

### TEP default table

The terminal error program (TEP) default table contains the “number and time” thresholds for each type of error to be controlled and accounted for. An index array at the beginning of the default table serves a dual function. If the value in the index is positive, then the error code has a permanently defined ESE in each TEB and the index value is the displacement to the reserved ESE. If the index value is negative, then an ESE must be assigned dynamically from a reusable ESE if one has not already been created by a prior occurrence. The complement of the negative index value is the displacement to the thresholds for the error type retained in the TEP default table.

## Structure of the sample terminal error program

The structure of the sample terminal error program (DFHXTEP) can be broken down into six major areas as follows:

1. Entry and initialization
2. Terminal identification and error code lookup
3. Error processor selection
4. Error processing execution
5. General exit
6. Common subroutines.

These areas are described in detail in the sections that follow.

Figure 22 on page 456 gives an overview of the structure of the sample terminal error program.

### **Entry and initialization**

On entry, the sample TEP uses DFHEIENT to establish base registers and addressability to EXEC Interface components. It obtains addressability to the communication area passed by DFHTACP by means of an EXEC CICS ADDRESS COMMAREA, and addressability to the EXEC interface block with an EXEC CICS ADDRESS EIB command. It gets the address of the TACLE from the communication area, and establishes access to the TEP tables with an EXEC CICS LOAD. If time support has been generated, the error is time-stamped for subsequent processing. (Current time of day is passed in the communication area.) The first entry into the sample TEP after the system is initialized causes the TEP tables to be initialized.

### **Terminal ID and error code lookup**

After the general entry processing, the TEP error table is scanned for a terminal error block (TEB) entry for the terminal associated with the error. If no matching entry is found, a new TEB is created. If all TEBs are currently in use (if no reusable TEBs are available), the processing is terminated and a RETURN request is issued, giving control back to DFHTACP, where default actions are taken.

After the terminal's TEB has been located or created, a similar scan is made of the error status elements (ESEs) in the TEB to determine whether the type of error currently being processed has occurred before, or if it has permanently reserved ESE space. If an associated ESE is not found, an ESE is assigned for the error type from a reusable ESE. If a reusable ESE does not exist, the error is accounted for in the terminal's common error bucket. The addresses of the appropriate control areas (TEB and ESE) are placed in registers for use by the appropriate error processor.

### **Error processor selection**

User-specified message options are selected and the messages are written to a specified transient data destination. The type of error code is used as an index to a table to determine the address of an error processor to handle this type of error. If the error code is invalid, or the sample TEP was not generated to process this type of error, the address points to a routine that optionally generates an error message and returns control to DFHTACP, where default actions are taken. If an address of a valid error processor is obtained from the table, control is passed to that routine.

### **Error processing execution**

The function of each error processor is to determine whether the default actions established by DFHTACP for a given error, or the actions established by the error processor, are to be performed. The common error bucket is processed by the specific error processor. However, the thresholds of the common error bucket are used in determining whether the limit has been reached. Subroutines are provided in the sample TEP to maintain count and time threshold totals for each error associated with a particular terminal to assist the error processor to make its decision. Also available are subroutines for logging the status of the error and any recovery action taken by the error processor.

You can replace any of the error processors supplied in the sample TEP with user-written ones. Register linkage conventions, error conditions, DFHTACP default actions, and sample TEP error processor actions are described in comments given in the sample DFHXTEP source listing. However, sample DFHXTEP actions, in many cases, can be altered by changing the thresholds when generating the TEP tables.

## General exit

Control is passed to a general exit routine from each error processor. This routine determines whether the terminal is to remain in service. If the terminal is to be put out of service, the terminal error block and all error status elements for that terminal are deleted from the TEP error table unless the terminal was defined as a permanent entry. When the terminal is placed back in service, a new terminal error block is assigned if a subsequent error occurs.

## Common subroutines

A number of subroutines are provided in the sample DFHXTEP for use by the error processors. Each subroutine entry has a label of the form "TEPxxxx" where "xxxxx" is the subroutine name. All labels within a subroutine start with TEPx where "x" is the first character of the subroutine name. All subroutines are arranged within the module in alphabetical order in the subroutine section. Register conventions and use of the subroutine are given as comments at the beginning of each subroutine in the source listing.

The following subroutines are available for writing your own error processors:

### TEPACT

Used to output the names of the action bits set by DFHTACP and the sample DFHTEP in the communication area field **TEPCA**CT if appropriate PRINT options are selected when the program is generated.

### TEPDEL

Used to delete the terminal error block and error status elements for a terminal from the TEP error table on exit from an error processor.

### TEPHEXCN

Used by TEPPUTTD to convert a 4-bit hexadecimal value to its 8-bit printable equivalent.

### TEPINCR

Used to update and test the count and time threshold totals maintained in the terminal's error status element.

### TEPLOC

Used to locate or assign terminal error blocks and error status elements for a terminal ID.

### TEPPUTTD

Used to output character or hexadecimal data to a user-defined transient data destination.

### TEPTMCHK

Used by TEPINCR to determine whether the time threshold has been passed.

### TEPWGHT

Used to update the weight/time threshold values maintained in the terminal's error status elements.

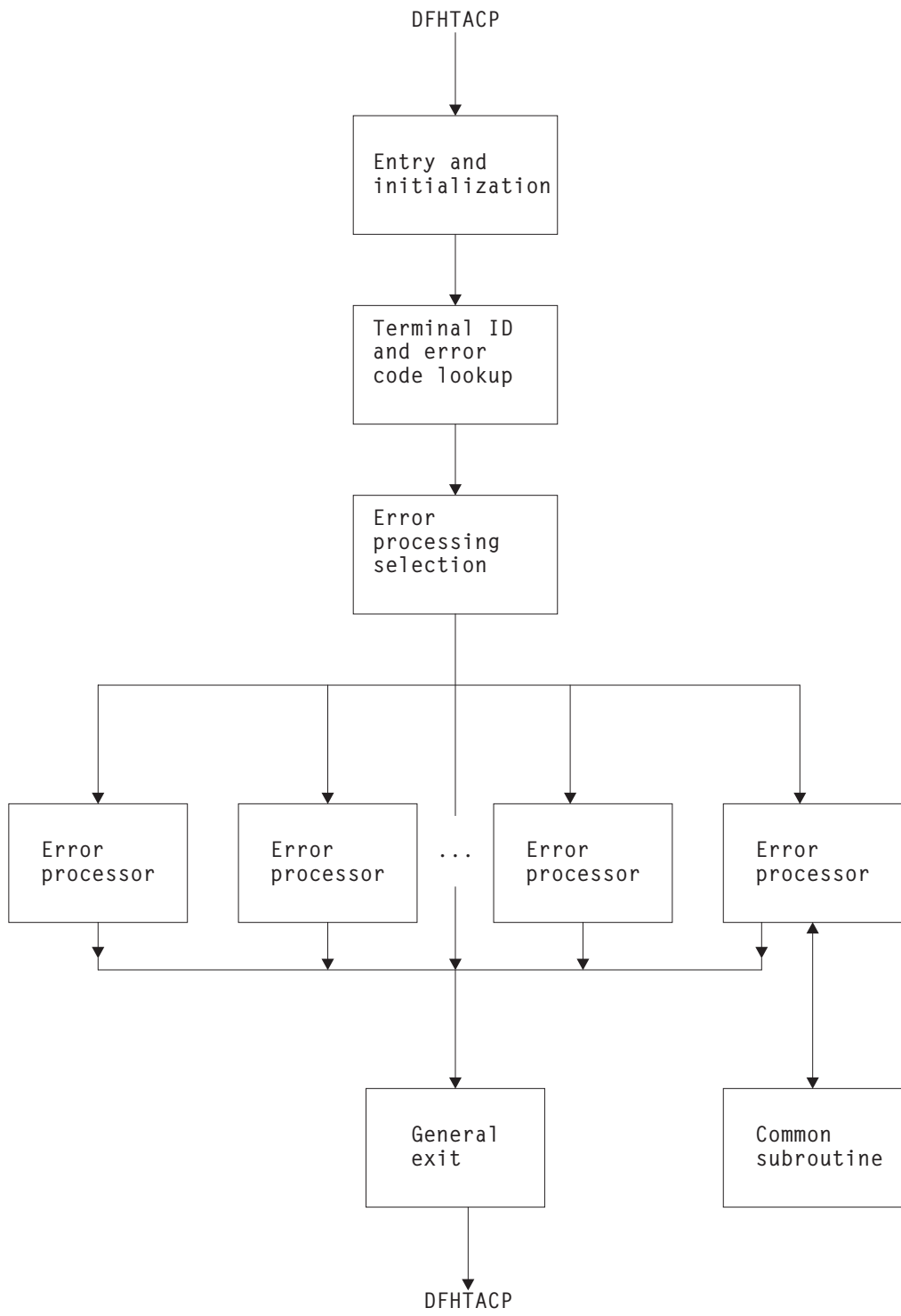

Figure 22. Overview of the sample terminal error program (DFHXTEP)

### Sample terminal error program messages

The messages logged to the transient data destination CSMT (or, optionally, to the destination specified in the OPTIONS operand of DFHXTEPM TYPE=INITIAL) are of six types, each identified by a unique message prefix. You can control the selection

of each type of message by using the appropriate parameters specified on the PRINT operand of DFHTEPM TYPE=INITIAL.

These messages are:

**DFHTEP, ERROR – error text**

During DFHTEP module generation, the PRINT parameter specified ERRORS. This message can be suppressed by using the NOERRORS option. The error text is one of the following:

**Unsupported error code, "xx"**

The error code presented to DFHTEP by DFHTACP is unknown to DFHTEP.

**"DFHTEPT" not defined in system**

The DFHTEP table could not be loaded into storage.

**Unknown error status message, "xxxx"**

The error status message presented from a remote 3270 type device could not be decoded.

None of these errors should occur.

**DFHTEP, ACTION – action flag names**

During DFHTEP module generation, the PRINT parameter specified TACP ACTION or TEP ACTION or both. If both are specified, this message is logged twice each time DFHTEP is called. The first message indicates the action flags as set by DFHTACP on entry to DFHTEP. The second message indicates the action flags as returned to DFHTACP by DFHTEP after error processing. These messages can be suppressed by using the NOTACP ACTION and NOTEP ACTION options.

The action flag names and descriptions are listed below. For further information about the actions taken by DFHTACP, see the description of the TEP CA ACT field in "Addressing the contents of the communication area" on page 471.

**Flag name**

**Description**

**LINEOS**

Place line out of service

**NONPRGT**

Nonpurgeable task exists on terminal

**TERMOS**

Place terminal out of service

**ABENDT**

Abend task on terminal

**ABORTWR**

Abort write, free terminal storage

**RELTIOA**

Release incoming message

**SIGNOFF**

Sign off terminal.

**DFHTEP, TID - tid**

During the DFHTEP module generation, the PRINT parameter specified TID.

This message contains the symbolic terminal ID of the device associated with the error. This message can be suppressed by using the NOTID option.

**DFHTEP, DECB - DECB information**

During the DFHTEP module generation, the PRINT parameter specified DECB. This two-line message contains the DECB (printed in hexadecimal format) of the terminal causing the error. The DECB is contained in the TACLE (displacement +16 [decimal]). See the TACLE DSECT described in “Writing your own terminal error program” on page 470. This message can be suppressed by using the NODECB option.

**DFHTEP, TACLE - TACLE information**

During the DFHTEP module generation, the PRINT parameter specified TACLE. This message (printed in hexadecimal format) contains the first 16 bytes of the TACLE passed to DFHTEP by DFHTACP. See the TACLE DSECT described in “Writing your own terminal error program” on page 470. This message can be suppressed by using the NOTACLE option.

**DFHTEP, ESE - ESE information**

During the DFHTEP module generation, the PRINT parameter specified ESE. This message contains the error status element. The message can be suppressed by using the NOESE option.

An ESE is either 6 bytes or 12 bytes long, depending on whether the TIME option was specified when generating the TEP tables. The formats are as follows:

*Table 21. Format of error status element on DFHTEP, ESE messages—NOTIME specified*

Display	Length (bytes)	Significance — NOTIME specified
0	2	Error threshold counter or weight value in binary format
2	2	Current error count or weight value in binary
4	1	Error code
5	1	Not used.

*Table 22. Format of error status element on DFHTEP, ESE messages—TIME specified*

Display	Length (bytes)	Significance — TIME specified
0	5	Error threshold counter or weight value in binary format
5	3	Timed threshold value in hundredths of a second
8	4	Time of first occurrence of this error. Time given as binary integer in hundredths of a second.

## Generating the sample terminal error program

For information about how to generate the sample terminal error program and the sample terminal error table, refer to “Assembling and link-editing user-replaceable programs” on page 436.

The sample program and tables provide you with default error processing for terminal errors. If you want to replace the supplied error processors with user-written error processors, you must use the DFHTEPM and DFHTEPT macros to generate a sample error program and tables that include your user-written routines. Some of the parameters specified in the DFHTEPM and DFHTEPT



macros are related and care must be taken to ensure compatibility. The parameters concerned are identified in the descriptions of the macros later in this chapter.

If you use the sample terminal error program (DFHXTEP), you can generate the required program and transaction definitions by using the CEDA INSTALL GROUP(DFHSTAND) command.

### Job control for generating the sample terminal error program

The generation of the sample terminal error program consists of two separate assembly and link-edit steps, one to create the sample TEP module itself, and the other to create the TEP tables. The names under which the components must be link-edited are:

#### DFHTEP

Sample TEP module, assembled from DFHXTEP

#### DFHTEPT

Sample TEPT table, assembled from DFHXTEPT.

For information about the job control statements necessary to assemble and link-edit user-replaceable programs, refer to “Assembling and link-editing user-replaceable programs” on page 436.

### DFHTEPM—generating the sample DFHTEP module

The sample DFHTEP module is generated by the following macros:

- DFHTEPM TYPE=USTOR—to indicate the start of user storage definitions.
- DFHTEPM TYPE=USTOREND—to indicate the end of user storage definitions.
- DFHTEPM TYPE=INITIAL—to control the printing of CICS DSECTs, provide optional routines, and indicate the type of information to be logged when errors occur.
- DFHTEPM TYPE=ENTRY—to code a user “ENTRY” routine.
- DFHTEPM TYPE=EXIT—to code a user “EXIT” routine.
- DFHTEPM TYPE=ERRPROC—to allow you to replace the error processors supplied with the sample terminal error program with user-written versions.
- DFHTEPM TYPE=FINAL—to indicate the end of the sample DFHTEP module.

**Note:** You must code the translator options NOPROLOG and NOEPILOG in your error processors if you use these macros.

```
DFHTEPM TYPE=USTOR
```

This macro indicates the start of user storage definitions. It must be followed by your storage definitions, and then by DFHTEPM TYPE=USTOREND. If you use DFHTEPM TYPE=USTOR to define storage, then both it and DFHTEPM TYPE=USTOREND must be coded **before** DFHTEPM TYPE=INITIAL.

```
DFHTEPM TYPE=USTOREND
```

This macro indicates the end of user storage definitions. Its use is mandatory if DFHTEPM TYPE=USTOR has been coded. If you use DFHTEPM TYPE=USTOR to define storage, then both it and DFHTEPM TYPE=USTOREND must be coded **before** DFHTEPM TYPE=INITIAL.

```
DFHTEPM TYPE=INITIAL
[,DSECTPR={YES|NO}]
[,OPTIONS=(TD|(TD,destid)|NOTD)
[,EXITS|,NOEXITS]
[,TIME|,NOTIME]
[,PRINT=(ERRORS|NOERRORS)
[,TACPACTION|,NOTACPACTION]
[,TEPACTION|,NOTEPACTION]
[,TID|,NOTID]
[,DECB|,NODECB]
[,TACLE|,NOTACLE]
[,ESE|,NOESE))]
```

**TYPE=INITIAL**

establishes the beginning of the generation of the sample DFHTEP module itself.

**DSECTPR={YES|NO}**

controls the printing of CICS DSECTs on the sample DFHTEP assembly listing. Its purpose is to reduce the size of the listing. The default is DSECTPR=YES.

YES

Printing of the DSECTs is allowed.

**NO** Printing of selected CICS DSECTs is suppressed. This parameter should not be used under Assembler F.

**OPTIONS=optional-routines**

includes or excludes optional routines in the DFHTEP module. The parentheses are required even when only one option is specified. If this operand is omitted, all default options are generated.

TD|(TD, destid)|NOTD

specifies whether information regarding the errors is to be written to a transient data destination.

TD The transient data output routine is to be generated. The implied transient data destination is CSMT.

**(TD, destid)**

The transient data output routine is to be generated. The messages are sent to the destination specified by “destid”, which must be defined in the destination control table.

**NOTD**

No messages are to be written to a transient data destination.

**EXITS|NOEXITS**

specifies whether “ENTRY” and “EXIT” user routine support is to be included.

**EXITS**

Branches are taken to ENTRY and EXIT routines before and after error processing. Dummy routines are provided if user routines are not used.

**NOEXITS**

No branches are taken to user routines.

TIME|NOTIME

specifies whether threshold tests are to be controlled over prescribed time intervals. An example might be putting a terminal out of service if more than three instances of a given type of error occur in one hour. The parameter must be the same as the OPTIONS operand in the DFHTEPT TYPE=INITIAL macro.

**TIME**

This type of threshold testing is supported.

**NOTIME**

This type of threshold testing is not supported.

**PRINT=print-information**

specifies which types of information are to be logged to the transient data destination each time an error occurs. If NOTD is specified on the OPTIONS operand, all PRINT parameters default to NO. All PRINT parameters require the transient data output routine. The parentheses are required even when only one parameter is specified.

**ERRORS|NOERRORS**

specifies whether unprocessable conditions detected by the sample DFHTEP are to be recorded on the transient data destination.

**ERRORS**

Error messages are to be logged.

**NOERRORS**

No error messages are to be logged.

**TACPACTION|NOTACPACTION**

specifies whether DFHTACP default actions are to be recorded on the transient data destination.

**TACPACTION**

The default actions are logged.

**NOTACPACTION**

No default actions are logged.

**TEPACTION|NOTEPACTION**

specifies whether the actions selected as a result of sample DFHTEP processing are to be recorded on the transient data destination.

**TEPACTION**

The final actions are logged.

**NOTEPACTION**

No final actions are logged.

**TID|NOTID**

specifies whether the symbolic terminal ID of the terminal associated with an error is to be recorded on the transient data destination.

**TID**

The terminal ID is to be logged.

**NOTID**

No terminal IDs are to be logged.

**DECB|NODECB**

specifies whether the DECB of the line associated with error is to be recorded on the transient data destination.

**DECB**

The DECB is logged. The hexadecimal representation of the DECB is logged as two 24-byte messages.

**NODECB**

No DECB logging occurs.

**TACLE|NOTACLE**

specifies whether the TACLE prefix is to be recorded on the transient data destination.

**TACLE**

The 16-byte TACLE prefix as received from DFHTACP is logged.

**NOTACLE**

No TACLE prefix logging occurs.

**ESE|NOESE**

specifies whether the ESE associated with the error is to be recorded on the transient data destination.

**ESE**

The ESE, after being updated, and before being deleted (if the action puts the terminal out of service) is logged.

**NOESE**

No ESE logging occurs.

## **DFHTEPM TYPE=ENTRY and EXIT—for user entry and exit routines**

The sample DFHTEP provides guidance about how to prepare error processor routines, particularly with regard to register and subroutine linkage conventions. The routines must also observe the following restrictions:

- The error processor must be coded in assembler language.
- The first executable statement in the routine must be labeled TEPCDxx, where “xx” is the error code specified in the DFHTEPM TYPE=ERRPROC, CODE=errcode macro.
- Register usage conventions and restrictions are stated in the sample DFHTEP source.
- The error processor must exit to the sample DFHTEP symbolic label TEPRET.

The macro required for a user “ENTRY” routine is:

```
DFHTEPM TYPE=ENTRY
```

This macro must be immediately followed by user “ENTRY” routine code, starting with the label “TEPENTRY” and ending with a BR 14 instruction.

The macro required for a user “EXIT” routine is:

```
DFHTEPM TYPE=EXIT
```

This macro must be immediately followed by user “EXIT” routine code, starting with the label “TEPEXIT” and ending with a BR 14 instruction.

## **DFHTEPM TYPE=ERRPROC—replacing error processors**

The macro necessary to replace error processors supplied with the sample DFHTEP with user-written error processors is:

```
DFHTEPM TYPE=ERRPROC
, CODE=errcode
(followed by the appropriate error
processor source statements)
```

**TYPE=ERRPROC**

indicates that a CICS-supplied error processor routine is to be replaced with the user-written error processor that immediately follows the macro. This macro is optional; if used, it must follow the DFHTEPM TYPE=INITIAL macro. One DFHTEPM TYPE=ERRPROC macro must precede each user-written error processor source routine.

**CODE=errcode**

is used to identify the error code assigned to the appropriate error condition. These codes are listed in Figure 26 on page 474.

**DFHTEPM TYPE=FINAL—ending the sample DFHTEP module**

The macro to terminate the sample DFHTEP module is:

```
DFHTEPM TYPE=FINAL
```

This is followed by an END DFHTEPNA statement.

**DFHTEPM macro examples**

1. The following is an example of the minimum number of statements required to generate a sample DFHTEP module:

```
DFHTEPM TYPE=INITIAL  
DFHTEPM TYPE=FINAL  
END DFHTEPNA
```

This example generates a sample DFHTEP module with CICS-supplied error processors and all default options. This is equivalent to the CICS-supplied sample terminal error program.

2. Figure 23 on page 464 is an example of a more tailored sample DFHTEP module. In this example no 3270 support is generated. All default types of information except for TACP and TEP actions are to be logged to the TEPQ transient data destination. The CICS DSECTs are not printed on the sample DFHTEP assembler-language listing. There are two error processor routines (codes '87' and '9F' respectively).

```

* GENERATE USER STORAGE

    DFHTEPM      TYPE=USTOR
USORFLD  DS  F
    DFHTEPM      TYPE=USTOREND

* MODULE SPECIFICATIONS

    DFHTEPM      TYPE=INITIAL,
                  OPTIONS=((TD,TEPQ),NO3270,EXITS),
                  PRINT=(NOTEPACTION,NOTACPACTION),
                  DSECTPR=NO
*
*
*
*
* USER-SUPPLIED ERROR PROCESSORS

    DFHTEPM      TYPE=ERRPROC, CODE=87
TEPCD81  DS  0H
    -
    - error processor "87" source statements
    -
    B  TEPRET

    DFHTEPM      TYPE=ERRPROC, CODE=9F
TEPCD9C  DS  0H
    -
    - error processor "9F" source statements
    -
    B  TEPRET

* USER "EXIT" EXIT CODE

    DFHTEPM      TYPE=EXIT
TEPEXIT  DS  0H
    -
    -
Additional user source statements to be executed after
error processing:
    -
    -
    BR  R14

* CONCLUDE MODULE GENERATION

    DFHTEPM      TYPE=FINAL
END DFHTEPNA

```

Figure 23. Example of DFHTEPM macros used to generate a sample DFHTEP module

## DFHTEPT—generating the sample DFHTEP tables

The following macros are required to generate the terminal error program tables:

- DFHTEPT TYPE=INITIAL—to establish the control section.
- DFHTEPT TYPE=PERMTID—to define permanently reserved terminal error blocks (TEBs) for specific terminals.
- DFHTEPT TYPE=PERMCODEIERRCODE—to define permanently reserved error status elements (ESEs).
- DFHTEPT TYPE=BUCKET—to define specific error conditions to be accounted for in the common error bucket.
- DFHTEPT TYPE=FINAL—to end the set of DFHTEPT macros.

## DFHTEPT TYPE=INITIAL—establishing the control section

The DFHTEPT TYPE=INITIAL macro necessary to establish the control section for the TEP tables is:

```
DFHTEPT TYPE=INITIAL
        ,MAXTIDS=number
        [,MAXERRS={25|number}]
        [,OPTIONS={TIME|NOTIME}]
```

### **TYPE=INITIAL**

establishes the beginning of the generation of the TEP tables.

### **MAXTIDS=number**

specifies the total number of permanent and reusable terminal error blocks to be generated in the TEP error table. Permanent entries are defined by the DFHTEPT TYPE=PERMTID macro described later in this section. Any entries not defined as permanent are reused when the terminal is taken out of service, or are deleted at the request of an error processor. If an error occurs, and no TEB space is available, the error is not processed, and DFHTACP default actions are taken. The minimum number of blocks is 1. A maximum number is not checked for but should be no greater than the number of terminals in your network.

### **MAXERRS=25|number**

specifies the number of errors to be recorded for each terminal. This value determines the number of permanent and reusable error status elements in each TEB. The maximum number that can be specified is 25 (the default value). If more are requested, only the maximum are generated. If fewer are requested, one extra ESE is generated for each TEB. The extra ESE is the common error bucket. Permanently reserved ESEs are defined by the DFHTEPT TYPE=PERMCODE macro described later in this section. Any ESEs not defined as permanent are dynamically assigned on the first occurrence of a nonpermanent error type associated with the terminal. By defining a number less than the maximum, and allowing the sample DFHTEP to assign ESEs dynamically, you can minimize the size of the table and still control and account for the error types relevant to the network. The minimum number that can be specified is zero. In this case only a common error bucket is generated.

### **OPTIONS={TIME|NOTIME}**

specifies whether time threshold space is to be reserved in support of the TIME option specified in the DFHTEPM TYPE=INITIAL macro. The default is OPTIONS=TIME.

#### **TIME**

Time threshold space is reserved.

#### **NOTIME**

Time threshold space is not reserved.

## DFHTEPT TYPE=PERMTID—assigning permanent terminal error blocks

The DFHTEPT TYPE=PERMTID macro to define permanently reserved terminal error blocks for specific terminals is:

```
DFHTEPT TYPE=PERMTID
        ,TRMIDNT=name
```

**TYPE=PERMTID**

defines permanently reserved terminal error blocks for specific terminals. Permanent TEBs are defined for terminals that are critical to system operation to ensure that error processors are always executed in the event of errors associated with that terminal. If no permanent TEBs are to be defined, this macro is not required. A separate macro must be issued for each permanently reserved TEB. The maximum number of permanent TEBs is the number specified in the MAXTIDS operand of the DFHTEPT TYPE=INITIAL macro.

**TRMIDNT=name**

is used to provide the symbolic terminal ID (1-4 characters) for a permanently defined TEB. Only one terminal can be specified in each macro.

**DFHTEPT TYPE=PERMCODE|ERRCODE—defining error status elements**

The DFHTEPT TYPE=PERMCODE|ERRCODE macro is used to change the default threshold constants of the sample DFHTEP, and to define permanently reserved error status elements:

```
DFHTEPT TYPE={PERMCODE|ERRCODE}
        ,CODE={errcode|BUCKET}
        [,COUNT=number]
        [,TIME=(number[,SEC|,MIN|,HRS])]
```

**TYPE={PERMCODE|ERRCODE}**

identifies whether the error code specified in the macro is to have a permanently reserved or a dynamically assigned ESE. These macros are required only if permanently reserved ESEs are to be defined, or if the sample DFHTEP default threshold constants are to be overridden. These are listed in Table 23 on page 468.

**PERMCODE**

Identifies the error code specified as having a permanently reserved ESE. Each permanently reserved ESE must be identified by a separate DFHTEPT TYPE=PERMCODE macro. All DFHTEPT TYPE=PERMCODE macros must precede all DFHTEPT TYPE=ERRCODE macros.

**ERRCODE**

Indicates that the error code specified does not require a permanently reserved ESE, but that the sample DFHTEP default threshold constants are to be changed. Each error code requiring a threshold constant change, other than those defined as permanently reserved, must be identified by a separate DFHTEPT TYPE=ERRCODE macro. All DFHTEPT TYPE=ERRCODE macros must follow all DFHTEPT TYPE=PERMCODE macros.

**CODE={errcode|BUCKET}**

identifies the error code referred to by the TYPE=PERMCODE|ERRCODE parameter. These codes are listed in Figure 26 on page 474. CODE=BUCKET is only applicable to the DFHTEPT TYPE=ERRCODE macro. It is used to override the default threshold constants established for the common error bucket.

**COUNT=number**

can be used in either the DFHTEPT TYPE=PERMCODE or TYPE=ERRCODE macro to override the sample DFHTEP default count threshold (see Table 23 on page 468). When the number of occurrences of the error type specified reaches the threshold, an error processor normally takes a logic path that causes DFHTACP



default actions to be taken. If the number of occurrences is less than the threshold, the error processor normally takes a logic path that overrides the DFHTACP default actions. The updating and testing of the current threshold counts are normally performed by a DFHTEP subroutine that sets a condition code that the error processor can test to determine whether the limit has been reached. **If you specify 0 as the number in the COUNT operand, you are not told when the threshold is reached.**

**TIME=(number[,SEC|,MIN|,HRS])**

can be used in either the DFHTEPT TYPE=PERMCODE or TYPE=ERRCODE macros to override the sample DFHTEP default time threshold (see Table 23 on page 468). This operand is only applicable when OPTIONS=TIME is specified on both the DFHTEPM and DFHTEPT TYPE=INITIAL macros. When the number of occurrences reaches the threshold specified on the COUNT operand (above) within the interval specified on this parameter, an error processor normally takes a logic path that causes DFHTACP default actions to be taken. If the number of occurrences within the interval is less than the threshold, the error processor normally takes a logic path that overrides the DFHTACP default actions. If the time interval has expired, the sample DFHTEP subroutine that normally updates and tests the current threshold count resets the occurrence counts, and establishes a new expiration time. In this case, the condition code set by the subroutine indicates that the thresholds had not been reached.

Time control in the sample DFHTEP starts with the first occurrence of an error type. Subsequent occurrences of the same error type **do not** establish new starting times, but are accounted for as having occurred within the interval started by the first occurrence. This continues until an error count reaches the threshold within the interval started by the first occurrence, or until the interval has expired. In the latter case, the error being processed becomes a first occurrence, and a new interval is started. A time interval of 0 means that the number of occurrences is to be accounted for and controlled without regard to a time interval. Zero is the implied time interval if the value of the COUNT operand is 0 or 1. It is also the implied time interval if the time options are not generated.

The time interval can be expressed in any one of four units; hours, minutes, seconds, or hundredths of a second. The maximum interval must be the equivalent of less than 24 hours. A practical minimum would be 1 to 2 minutes. This allows for access method retries and the time required to create the task to service each error. The four methods of expressing the threshold time interval are:

**number**

The interval in units of one hundredth of a second. Parentheses are not required if this method is used. The maximum number must be less than 8 640 000 (24 hours).

**(number,SEC)**

The interval in whole seconds, which must be enclosed in parentheses. The maximum number must be less than 86 400 (24 hours).

**(number,MIN)**

The interval in whole minutes, which must be enclosed in parentheses. The maximum number must be less than 1440 (24 hours).

**(number,HRS)**

The interval in whole hours, which must be enclosed in parentheses. The maximum number must be less than 24.

Table 23 illustrates the default thresholds of the sample terminal error program, referred to in the TYPE, COUNT, and TIME operands of the DFHTEPT TYPE=PERMCODEIERRCODE macro.

Table 23. Default thresholds of the sample TEP

CODE=	COUNT=	TIME=
81	3	(7,MIN)
84	1	0
85	1	0
87	50 (Note 2)	0
88	1	0
8C	1	0
8D	1	0
8E	1	0
8F	1	0
90	0	0
91	0	0
94	7	(10,MIN)
95 (Note 1)	0	0
96	2	(1,MIN)
97 (Note 1)	0	0
99	1	0
9F (Note 1)	0	0
BUCKET	5	(5,MIN)

**Notes:**

1. The error processor maintains an error count only. DFHTACP default actions are always taken regardless of the thresholds.
2. The error processor uses a threshold “weight” instead of a threshold count (see the source code of the sample DFHTEP).

## DFHTEPT TYPE=BUCKET—using the error bucket for specific errors

The DFHTEPT TYPE=BUCKET macro is used to ensure that specific error conditions are always accounted for in the common error bucket:

```
DFHTEPT TYPE=BUCKET
        ,CODE=errcode
```

### TYPE=BUCKET

generates the macro to account for specific error conditions in the common error bucket. If MAXERR=25 on the DFHTEPT TYPE=INITIAL macro, this macro cannot be used. This macro is not required if no error codes are to be specifically accounted for in the common error bucket. Each error code must be identified by a separate DFHTEPT TYPE=BUCKET macro.

### CODE=errcode

identifies the error code to be specifically accounted for in the common error bucket. The error code must not be specified in the DFHTEPT TYPE=PERMCODE or TYPE=ERRCODE macro.

## DFHTEPT TYPE=FINAL—terminating DFHTEPT entries

The DFHTEPT TYPE=FINAL macro terminates the generation of the DFHTEPT tables.

```
DFHTEPT TYPE=FINAL
```

### DFHTEPT—examples of how the macros are used

1. The following is an example of the minimum number of statements required to generate the TEP tables:

```
DFHTEPT TYPE=INITIAL,MAXTIDS=10
DFHTEPT TYPE=FINAL
END
```

This example generates 10 reusable terminal error blocks, each capable of accounting for the maximum number of error types. Time threshold control is supported, and all threshold values are the defaults supported by the sample DFHTEPT. This is equivalent to the CICS-supplied sample terminal error program.

2. Figure 24 is an example of a customized TEP table (continuation characters omitted).

#### \* TABLE SPECIFICATIONS

```
DFHTEPT TYPE=INITIAL,MAXTIDS=10,
MAXERRS=5
```

#### \* PERMANENT TERMINAL DEFINITIONS

```
DFHTEPT TYPE=PERMTID,TRMIDNT=TM02
```

#### \* PERMANENT ERROR CODE DEFINITIONS

```
DFHTEPT TYPE=PERMCODE,CODE=81
DFHTEPT TYPE=PERMCODE,CODE=87,
COUNT=2,TIME=(1,MIN)
```

#### \* OTHER THRESHOLD OVERRIDES

```
DFHTEPT TYPE=ERRCODE,CODE=BUCKET,
COUNT=3,TIME=(3,MIN)
```

#### \* CONCLUDE TABLE GENERATION

```
DFHTEPT TYPE=FINAL
END
```

Figure 24. Example of the use of DFHTEPT macros to generate DFHTEPT tables

This example generates 10 terminal error blocks, one of which is reserved for the terminal whose symbolic ID is TM02, and the other nine are reusable. Each TEB has space for five error status elements plus a common error bucket. Of the five ESEs, two are reserved for error codes '81' and '87'; the remaining ESEs are available to be assigned dynamically. The thresholds for error code '87' and the common error bucket are being changed. No specific error code is to be accounted for in the common error bucket.

---

## Writing your own terminal error program

You can write your own terminal error program in any of the languages supported by CICS. However, CICS-supplied code is provided in assembler language only. The names of the supplied source files and macros, and the libraries in which they can be found, are listed in Table 24.

Table 24. Supplied source files and macros

Name	Type	Description	Library
DFHXTEP	Source	Sample terminal error program (assembler language)	CICSTS32.CICS.SDFHSAMP
DFHXTEPT	CSECT	Sample terminal error tables (assembler language)	CICSTS32.CICS.SDFHSAMP
DFHTEPM	Macro	Sample TEP program generator (assembler language)	CICSTS32.CICS.SDFHMAC
DFHTEPT	Macro	TEP table generator (assembler language)	CICSTS32.CICS.SDFHMAC
DFHTEPCA	Macro	Assembler-language communication area	CICSTS32.CICS.SDFHMAC

The user-written DFHTEP receives control in the same manner as the CICS-supplied sample DFHTEP, described in “The communication area” on page 451. It should therefore use the communication area as its basic interface with DFHTACP.

## Why write your own terminal error program?

- There are some situations in which CICS may try to send a message to an input-only terminal; for example, an ‘invalid transaction ID’ message, or a message wrongly sent by an application program. You should provide a terminal error program to reroute these messages to a system destination such as CSMT or CSTL or other destinations, by means of transient data or interval control facilities.
- There could be application-related activity to be carried out when a terminal error occurs. For example, if a message is not delivered to a terminal because of an error condition, it may be necessary to notify applications that the message needs to be redirected.
- Not all errors represent communication-system failures - for example, SAM end-of-data conditions.

## Restrictions on the use of EXEC CICS commands

There are certain restrictions on the commands that a TEP can issue. **The use of any commands that require a principal facility causes unpredictable results, and should be avoided.** In particular, you should not use commands that invoke the following functions:

- Terminal control (“CEMT-type” commands, such as EXEC CICS INQUIRE TERMINAL, *are* permissible)
- BMS (except routing)
- ISC communication (including function shipping).

## Addressing the contents of the communication area

After your terminal error program receives control from DFHTACP, it should obtain the address of the communication area by means of an EXEC CICS ADDRESS COMMAREA command.

You generate the communication area DSECT by coding DFHTEPCA TYPE=DSECT in your program. The layout of the communication area is shown in Figure 25.

			IN/OUT PARM		
		0XL4		Standard Header	
TEPCALDS	DS	XL1	I	Function Code	Always '1'
TEPCAGDS	DS	XL2	I	Component Code	Always 'TC'
	DS	XL1		Reserved	
TEPCATCA	DS	A	I	Address of TACLE being processed	
TEPCECIA	DS	A	I	Address of TCTUA	
TEPCECIL	DS	H	I	Length of TCTUA	
TEPCAACT	DS	XL1	I/O	User action byte	
TEPCATID	DS	CL4	I	Terminal identity	
TEPCATDB	DS	F	I	Current time of day binary	

Figure 25. The DFHTACP/DFHTEP communication area

The parameter list contains the following information:

### TEPCALDS

Function Code. The Function Code is a printable character representing the identity of the task within the TCP which invoked DFHTEP. It always has the value '1'.

### TEPCAGDS

Component Code. This always has the value 'TC', representing a component of the TCP.

### TEPCATCA

Contains the address of the TACLE being processed.

### TEPCECIA

Contains the address of the terminal control table user area (TCTUA).

### TEPCECIL

Contains the length of the TCTUA.

### TEPCAACT

The User action byte. One of the main uses of the communication area is to transmit the actions that are to be taken for a terminal. TEPCAACT contains the following flags, which can be reset within DFHTEP:

#### LINEOS (X'80')

Place line out of service

#### NONPRGT (X'40')

Nonpurgeable task exists on the terminal

#### TERMOS (X'20')

Place terminal out of service

#### ABENDT (X'10')

Abend the task on the terminal

**ABORTWR (X'08')**

Abend write, free terminal storage

**RELTIOA (X'04')**

Release TCAM incoming message. (TCAM is no longer supported.)

**SIGNOFF (X'02')**

Call sign-off program.

On entry to DFHTEP, the above flags represent the default actions set by DFHTACP. The write-abend bit (communication area field **ABORTWR**) and the abend-task bit (communication area field **ABENDT**) are always set if the place-line-out-of-service bit (X'80') is set; but both bits are suppressed if "dummy terminal" is indicated (see "Resetting the flags in the user action byte, TEPCAACT").

On return to DFHTACP, the flags represent the actions as modified by DFHTEP.

**TEPCATID**

Contains the identity of the terminal in error.

**TEPCATDB**

Contains the time of day when the error occurred, in binary format.

**Resetting the flags in the user action byte, TEPCAACT**

The following factors should be considered when altering the action bits in TEPCAACT:

- You should consider how to preserve data security. For example, if a terminal is put out of service for some time (until the cause of the failure is removed) the signon information is still in the TCTTE when the terminal is put back into service, although the original operator may no longer be present. To prevent a possible security violation, you can set the **SIGNOFF** bit to sign off the terminal.
- The dummy terminal indicator at TCTLEPF2 is set on errors from which no specific terminal is indicated. Therefore, if a dummy terminal is indicated, abend task and abend write are not set (see below). The dummy terminal is only used to identify the line.
- The abend-task bit (X'10' in TEPCAACT) is always associated with two other bits as part of TACP's abend transaction processing. These other bits are nonpurgeable task and abend write (X'40' and X'08' respectively, both in TEPCAACT).
- Abend write is always set on at the same time as abend task. It has the effect of clearing the TCTTE of the original write request indicators, if the error being processed occurred on a TC WRITE.
- Nonpurgeable task is set on if a transaction is currently associated with the terminal, and the transaction ID was specified with TPURGE=NO.

None of the abend-task, abend-write, or nonpurgeable-task bits is set if the dummy terminal indicator is on, even if DFHTACP would normally set abend task as the default for the error being processed. Therefore, the following remarks apply only to errors related to a real terminal.

- Abend task has no effect if no transaction is associated with the terminal; (except where a pseudoconversational task is associated with the terminal, in which case, the next transid is cleared). Otherwise, if nonpurgeable task is indicated, the transaction remains attached to the terminal (normally in SUSPEND state)

and DFHTACP writes the 'DFHTC2522 INTERCEPT REQUIRED' message to CSMT; if the task is not marked nonpurgeable, it is abended with code 'AEXY' or, rarely, 'AEXZ'.

- Abend write has no effect if the TCTTE was associated with a READ request. In this case the normal result is that, if the line and terminal remain in service, the read is retried.

## Addressing the contents of the TACLE

The TACLE is created by the terminal control program when the error occurs, and contains all the I/O error information provided by BSAM.

To address the contents of the TACLE, the user-written terminal error program should contain the COPY DFHTACLE and COPY DFHTCTLE statements, in that order. These define the complete DFHTCTLE DSECT. The symbolic names in this DSECT are used to address fields in both the TACLE and the real line entry associated with the error.

The TACLE consists of a 16-byte prefix (defined by COPY DFHTACLE) and a further 48-byte section, which is a modified copy of the DECB of the real line entry at the time the TACLE was created.

To address the TACLE, the user-written terminal error program should therefore contain the statements:

```
COPY DFHTACLE
COPY DFHTCTLE
```

```
L TCTLEAR,TEPCATCA      POINT TO TACLE
USING DFHTCTLE,TCTLEAR
```

Note that fields normally part of the real line entry DECB have offsets increased by 16 in the TACLE.

The following fields in the DECB copy in the TACLE do **not** represent data copies from the real line entry:

```
TCTLEDCB                (Offset 24 in TACLE,
                          8 in real TCTLE)
```

This field in the TACLE points to the real line entry; in the real line entry, it points to the BSAM DCB for the line group.

```
TCTLECSW                (Offsets 46, 48 in TACLE,
                          30, 32 in real TCTLE)
```

These are used in the TACLE for SAM error information.

The following statements give direct addressability to the **real** line entry:

```
COPY DFHTCTLE
COPY DFHTCTTE
```

```
L      TCTLEAR,TEPCATCA      POINT TO TACLE
USING  DFHTCTLE,TCTLEAR
L      TCTTEAR,TCTLEPTE     POINT TO ERROR TCTTE
USING  DFHTCTTE,TCTTEAR
DROP   TCTLEAR
L      TCTLEAR,TCTTELEA     POINT TO TCTLE
USING  DFHTCTLE,TCTLEAR
```

After you have carried out the required functions and, optionally, altered the default actions scheduled by DFHTACP, the user-written DFHTEP must return control to DFHTACP by issuing the EXEC CICS RETURN command. DFHTACP then performs the actions specified in the TACLE and causes the error processing task to terminate.

The format of the TACLE DSECT is shown in Figure 26.

TERMINAL ABNORMAL CONDITION LINE ENTRY

Dec	Hex	4 BYTES		
0	0	TCTLEPSA STORAGE ACCOUNTING AREA		
4	4	RESERVED		
8	8	TCTLEPFL ERROR FLAGS	TCTLEPF2 SPECIAL IND	NOT USED
12	C	TCTLEPTE TCTTE ADDRESS		
16	10	TCTLEECB BEGINNING OF DECB	RESERVED FOR DFHTACP	NOT USED
20	14			
24	18	TCTLEDCB ACTUAL LINE ENTRY ADDRESS		
28	1C			
44	2C	NOT USED	TCTLECSW BSAM STATUS	
48	30	TCTLEALP BSAM SENSE		
60	3C	TCTLEOA		

Figure 26. Format description of the TACLE DSECT (part 1)



## Displacement

Dec	Hex	Code	Bytes	Label	Meaning
0	0		4	TCTLEPSA	Storage accounting
				RESERVED	
8	8	81	1	TCTLEPFL	Error flags Message too long
		84			TCT search error
		85			Write not valid
		87			Unsolicited input
		88			Input event rejected
		8C			Output event rejected
		8D			Output length of zero
		8E			No output area
		8F			Output area exceeded
		94			Unit check
		95			Unit check (should not occur)
		96			Unit exception
		97			Unit exception (should not occur)
		99			Undetermined I/O error
		9F			Invalid destination (TCAM: no longer supported)
		.			.
		.			(All codes not listed are reserved and are not intended for use by DFHTEP)
		.			.
9	9	01	1	TCTLEPF2	Special indicator dummy terminal
12	C		4	TCTLEPTE	Address of terminal entry for terminal in error
16	10		4	TCTLEECB	DECB/copy of line when error occurred
60	3C		4	TCTLEOA	For TCAM lines only. (No longer supported)

Figure 27. Format description of the TACLE DSECT (part 2)

## Example of a user-written terminal error program

The “DFHTEP recursive retry routine” on page 476 is an example of the logic steps necessary to design a portion of the terminal error program. In Figure 28 on page 477, 10 retries are provided for each terminal; however, the logic could be used for any number of retries. The following assumptions are made:

### USER FIELD A (PCISAVE)

represents a 6-byte field in the process control information (PCI) area of the TCTTE. This field is used to preserve the count of input and output from the TCTTE when the first error occurs. These counts are contained in 3-byte fields located at TCTTENI and TCTTENI within the TCTTE.

### USER FIELD B

**(PCICNT)**

represents a user-defined field used to accumulate the count of recursive errors. It should be in the process control information (PCI) area of the TCTTE.

**SYSTEM COUNT****(TCTTENI)**

represents the 6-byte field in the TCTTE that contains the terminal input and output counts (TCTTENI+TCTTENI). In the example, these two adjacent fields are considered as one 6-byte field.

Because this example requires access to the TCT terminal entry (TCTTE) to examine the SYSTEM COUNT and to locate the process control information (PCI) area, the DFHTCTTE symbolic storage definition is included so that fields can be symbolically referenced.

**DFHTEP recursive retry routine**

```

*ASM      XOPTS(NOPROLOG NOEPILOG SP)
*****
*
*              DFHTEP RECURSIVE RETRY ROUTINE
*
*****
          DFHEISTG
          DFHEIEND
          DFHTEPCA TYPE=DSECT      COMMAREA passed by TACP
          COPY  DFHA06DS          Statistics DSECT
          USING DFHA06DS,STATBAR
PCIAREA   DSECT
PCISAVE   DS    XL6              User Field A
PCICNT    DS    PL2              User Field B
*
TCTLEAR   EQU    2              Pointer to TACLE
STATBAR   EQU    4              Pointer to statistics DSECT
TCTUABAR  EQU    5              Pointer to TCTUA
COMMABAR  EQU    12             Pointer to COMMAREA passed by TACP
          EJECT
DFHTEP    CSECT
*****
*          Establish addressability
*
*****
          DFHEIENT
*
          EXEC CICS ADDRESS EIB(11)
*
          EXEC CICS ADDRESS COMMAREA(COMMABAR)
*
          USING DFHTEPCA,COMMABAR
          L      TCTLEAR,TEPCATCA   Load TACLE address
*
          USING PCIAREA,TCTUABAR
          L      TCTUABAR,TEPCECIA  Load TCTUA address
*
*****
*          Start processing
*
*****
          TM      PCICNT+1,X'0C'    Has User Field B been initialized
*                                     to a packed decimal number?
          BO      CKCOUNT          YES ... so compare the system count
*                                     with the existing count in Field B
RESET      DS    0H
          MVC     PCICNT,=PL2'+0'  NO ... so initialize field B to
*                                     packed zero.
*

```

Figure 28. DFHTEP recursive retry routine (part 1)

```

EXEC CICS COLLECT STATISTICS TERMINAL(TEPCATID) SET(STATBAR)
*                               Get statistics for this terminal
*                               using TERMID passed in Commarea
*
MVC  PCISAVE,A06TENI           Save the current system counts. This
*                               is a new error, or first time
*                               through.
INCR DS  0H
AP   PCICNT,=P'1'             Increment the number of times this
*                               error has occurred (recursive count)
*
CP   PCICNT,=P'10'           Has the maximum recursive error
*                               limit been reached?
BNE  RETRY                    NO .... set action
*
ZAP  PCICNT,=P'0'           Clear and reset user fields for next
*                               error set
EXEC CICS COLLECT STATISTICS TERMINAL(TEPCATID) SET(STATBAR)
*                               Get statistics for this terminal
*                               using TERMID passed in COMMAREA
*
MVC  PCISAVE,A06TENI           Get current system counts
B    NORETRY                  Action indicators for no retry
*
CKCOUNT DS  0H
EXEC CICS COLLECT STATISTICS TERMINAL(TEPCATID) SET(STATBAR)
*                               Get statistics for this terminal
*                               using TERMID passed in COMMAREA
*
CLC  PCISAVE,A06TENI           Has system count changed since last
*                               entry to TEP?
BNE  RESET                    YES .... this is a new error since
*                               some I/O activity has occurred on
*                               terminal.
B    INCR                     NO .... this is a recursive error,
*                               so increment the recursive count and
*                               check for retry.
RETRY DS  0H
*                               The user would include here the code
*                               necessary to alter the flags in the
*                               COMMAREA so that a retry can be
*                               performed on the terminal.
NORETRY DS  0H
*                               The user would include here the code
*                               necessary to allow DFHTACP to take
*                               final actions on the terminal; that
*                               is, abend task, put line out of
*                               service, and others.

LTORG ,
END

```

Figure 29. DFHTEP recursive retry routine (part 2)

Note that the code in Figure 28 on page 477 is intended only as an illustration of a recursive error handling technique and of the steps necessary to establish addressability to the applicable control blocks.

---

## Chapter 9. Writing a node error program

### Considerations common to all user-replaceable programs

Note that the comments contained in Chapter 5, “General notes about user-replaceable programs,” on page 435 apply to this chapter.

This chapter contains information about the node error program (NEP) of CICS Transaction Server for z/OS, Version 3 Release 2. Node error programs, not terminal error programs, must be used for terminals and logical units supported via the ACF/VTAM interface.

The chapter is divided into the following sections:

1. “Background to CICS-VTAM error handling” on page 480 is an overview. If you are not familiar with the node error program, you should read this section. If you are familiar with NEPs, you may be able to go straight to the detailed information in the following sections, and look at the subjects that particularly interest you.
2. “When an abnormal condition occurs” on page 486 describes the CICS components that are invoked when an abnormal condition is detected from a VTAM logical unit.
3. “The sample node error program” on page 496 describes the CICS-supplied sample NEP.
4. “Writing your own node error program” on page 505 discusses the factors you need to consider when writing your own node error program.
5. “Using the node error program with XRF or persistent sessions” on page 510.

#### Note:

1. Like the terminal error program for non-VTAM devices, the node error program for VTAM-attached terminals is available in three forms:
  - a. The default node error program
  - b. The CICS-supplied sample node error program
  - c. User-written versions.

All three types are discussed in the following sections.

2. In this chapter, “VTAM 3270” refers to a non-SNA 3270 connected through VTAM, and “3270 compatibility mode” refers to an SNA 3270 connected through VTAM.
3. If you code an EXEC CICS HANDLE CONDITION TERMERR command in your application program, it is **sometimes** possible for the application program to handle exceptional cases, rather than using a node error program. The ‘TERMERR’ condition is driven if the node abnormal condition program (DFHZNAC) actions an ABTASK (‘ATNI’ abend). Note that ‘TERMERR’ is application-related, and is not an alternative to the node error program, which must be used for session-related problems. Dealing with errors in the application program is particularly useful in an intersystem communication (ISC) environment. For further information, refer to ISC and IPIC intercommunications facilities, in the *CICS Intercommunication Guide*.

---

## Background to CICS-VTAM error handling

In general, errors detected by CICS-VTAM terminal control are queued for handling by a special task, the CICS node error handler (transid CSNE). (Note that CICS finds it convenient to use the same technique for some housekeeping work, such as sending “good morning” messages, and logging session starts and ends, which are not errors at all.)

In a few cases, exceptions signaled to CICS by VTAM are not treated as errors, and are not passed to the node error handler. For example, CICS often sends an SNA BID command as part of automatic transaction initiation. Rejection of the BID with exception code ‘0813’ (wait) is a standard response, and CICS handles the retry in terminal control without calling this an error. In the rest of this description, only the errors are considered.

The CSNE task runs as a “background” task, meaning that it is not associated with any one CICS terminal. At any time, there is at most one such task, working on the single node error queue.

All node errors on the queue are analyzed in turn by a table-driven, CICS-supplied program called DFHZNAC (node abnormal condition program). It is not intended that you should ever modify this.

DFHZNAC links to a module called DFHZNEP (if present in the CICS system) when processing most node errors. (It does **not** link to DFHZNEP for errors that are not related to a specific node—for example, those caused by a VTAM shutdown.) The interface for this link is described in “When an abnormal condition occurs” on page 486. This formal DFHZNAC-DFHZNEP interface gives you the opportunity to supply your own code to analyze error conditions, change default actions by setting various “action flags”, and take additional actions specific to your applications.

CICS supplies a pregenerated default DFHZNEP, which simply sets the “print TCTTE” action flag if a VTAM storage problem is detected, and returns control to DFHZNAC. Because it leaves all other action flags unchanged, DFHZNAC’s default actions are not otherwise affected. (DFHZNAC’s default actions for different error conditions are listed in Appendix B, “Default actions of the node abnormal condition program,” on page 855.)

### Why use a NEP to supplement CICS default actions?

The following list gives some of the reasons why you might want to write your own node error program to add to the default actions provided by CICS and VTAM.

- Not all errors represent communication system failures. Some errors (such as trying to write zero-length data) may reflect special situations in applications, needing special action.
- You might want to output extra data, in addition to the error messages sent by DFHZNAC. (Note that you cannot use the node error program to suppress messages from DFHZNAC.) All data output from DFHZNAC and DFHZNEP is written to the transient data queue CSNE.
- In other cases, you might want to change the amount of diagnostic information produced by CICS: the default varies with the error type. For example, the VTAM RPL associated with an error may be printed when you do not want it, or not printed when you do.
- There could be application-related activity to be performed when a node error occurs. For example, if a message fails to be delivered to a terminal, it may need

redirecting to another. With messages sent with exception-response only, CICS may not have the data available to send it again, but the requesting application might be able to re-create it. For example, if an error were signaled during the sending of a document to a printer, it might be able to restart from the beginning, or from a specific page.

- Some devices, such as the 3650 Retail Store System, return application-type data in “User Sense Data” fields. This can only be retrieved in a NEP. The NEP has to catch and save data for further application programs.

## An overview of writing a NEP

Your DFHZNEP module must conform to the defined interface: that is, it must be a linked-to program that uses defined communication area fields to analyze an error and then returns to DFHZNAC. The source code of the default NEP provided by CICS can be used as a skeleton on which to build a single NEP.

CICS also provides macros to help you generate more complex sample NEPs. These are **aids** to help you develop your own NEPs; you do not have to use any of them.

Your error-handling logic can be written as a number of modules, but the one that receives control from DFHZNAC must be called DFHZNEP.

DFHZNEP code can use standard CICS functions (LINK, XCTL) to invoke other user modules. Each module thus requested must have either an installed CSD program definition or an autoinstalled program definition. Program resource definitions for DFHZNAC and DFHZNEP themselves are provided in the IBM-supplied CSD group, DFHVTAM.

The key features of the DFHZNAC-DFHZNEP interface are as follows:

- DFHZNEP can be written in any of the CICS-supported languages.

**Note:** CICS-supplied NEP code is provided in assembler language only. The communication area parameter list is supplied in assembler-language and C versions.

- DFHZNEP is linked-to separately for each node-related error on the queue. (Note that, because sense codes are always associated with an error, DFHZNEP is not linked-to separately for these.)
- Communication between the two modules is through a communication area (DFHNEPCA).

The structure of the communication area is described in “The communication area” on page 487.

On each DFHZNEP invocation, one field in the communication area contains a 1-byte internal error code, assigned by DFHZNAC, which identifies the type of error. Other fields identify the CICS TCTTE (LU) associated with the error, and any SNA sense codes. There are also fields for DFHZNEP to pass back user messages for subsequent logging by DFHZNAC.

Further fields contain “action flags”. Each flag represents an action that DFHZNAC may take when DFHZNEP returns control to it. These actions are of different types:

- Reporting (dumps of control blocks, actions taken)
- Status changes (for example, of TCTTE)
- Clean-up work (cancel any associated transaction, end the VTAM session).

The action flags can be set or reset within DFHZNEP.

The action flags set by DFHZNAC for specific error codes and sense codes are listed in Appendix B, “Default actions of the node abnormal condition program,” on page 855.

## The default NEP

The CICS-supplied default NEP, DFHZNEP, sets the “print TCTTE” action flag (TWAOTCTE in the user option byte TWAOPT1—see page “The user option bytes (TWAOPTL)” on page 491) if a VTAM storage problem is detected; otherwise it performs no processing, leaves the action flags set by DFHZNAC unchanged, and returns control to DFHZNAC.

## The sample NEP

The CICS sample node error program is a generalized program structure for handling errors detected from logical units. None of its components is generated as part of the standard CICS generation process, but instead may be optionally generated as described in this section and in “The sample node error program” on page 496.

The sample NEP that CICS provides is designed with two main features:

- It assumes that you want to invoke separate user-supplied error processors to handle different “groups” of error types. You specify which of the DFHZNAC internal error codes are to be regarded as a “group” for processing by any one routine, and then supply the code for that routine. CICS has some standard cases to help you. More information is given about them below.
- The supplied error processors may work in association with a separately generated module called a node error table. This can be used to build up statistics for each error group that the NEP processes. This table is analogous to the terminal error table, DFHTEPT, used by the sample terminal error program.

Some of the CICS-supplied error processors use the node error table—for example, that for errors affecting 3270 LUs (GROUP=1) (see “DFHSNEP TYPE=DEF3270—including error processors for 3270 LUs” on page 500).

### The node error table

To understand the sample NEP, first look at the node error table structure in more detail.

Node error table is often abbreviated to NET. You should not confuse this acronym with “net” (as in “network”), or with a NETNAME.

You can generate a node error table using the CICS macro DFHSNET. See “Node error table” on page 497 and “DFHSNET—generating the node error table” on page 503. You choose how complex this table is to be.

The node error table must be defined as a RESIDENT program. This makes it easy for the NEP to find it (using a CICS LOAD request), and ensures that any counters are not reset by reloading. You can give the table any name you like. The default is DFHNET.

The table consists of sets of error-recording areas. Each set is called a node error block (NEB) and is used to count node errors relating to a single LU. You can dedicate specific NEBs to specific LUs throughout a CICS run; and you can leave



other, reusable NEBs for general use. If you expect to accumulate error statistics about 10 LUs concurrently, you need 10–12 NEBs.

Each NEB may contain multiple recording areas, one being used for each group of errors you want to distinguish. The error groups correspond to those in the NEP. That is, they are groups of error types requiring separate processing logic.

Each recording area is known as an error status block (ESB). You specify the space reserved for each ESB, and it typically includes space to count the errors, or record when the first of the present series occurred. Note that in any one NEB the counting is for one LU only.

Finally, you can specify a threshold count and a time limit in the table. These are constants that can be used by code in the NEP to test an ESB, to see if a given type of error has occurred more than the threshold number of times in the stated interval. The time limit also affects the interval between using a general NEB for one LU and then reusing it for another.

A minimal NET would simply consist of a handful of NEBs, each with just one ESB, grouping together all types of error that are of interest.

### **Coding the sample NEP**

The sample NEP is coded using the macro DFHSNEP. The basic form is as follows:

```
DFHSNEP TYPE=INITIAL
```

Specific error handling code. For example:

```
DFHSNEP TYPE=DEF3270
```

```
DFHSNEP TYPE=FINAL  
END      DFHNEPNA
```

By default, this generates a module called DFHZNEP, which works with a node error table called DFHNET. If you want to use another table, you could code NETNAME=MYTABLE after TYPE=INITIAL. Details of the DFHSNEP macro are given in “Generating the sample node error program” on page 499.

To understand the sample code, generate a standard NEP, as with TYPE=DEF3270, shown in “DFHSNEP TYPE=DEF3270—including error processors for 3270 LUs” on page 500, and look at the resulting assembler-language listing. Here is a description of the code.

The INITIAL and FINAL macros generate the basic skeleton of the NEP. This comprises some initialization code and some common routines. All the code is built round the assumption that you have a node error table as previously described.

The initial code first tests the internal error code passed from DFHZNAC to see if it belongs to a group that the NEP needs to handle. (The groups are identified by the code you supply between the DFHSNEP INITIAL and FINAL macros. This is described in “Generating the sample node error program” on page 499.) If the particular error code is not of interest to the NEP, control is returned at once to DFHZNAC, to take default actions.

Otherwise, the relevant node error table is located by a CICS LOAD request. (As previously explained, this table should be resident in virtual storage.) The NEP code

will then locate the correct ESB within a selected NEB. The latter may be permanently dedicated to the LU in error (a named NEB), or may be one taken from the general pool.

The initial code then invokes the appropriate user logic for that error group. The initial code also sets up pointers to the communication area, the NEB, and the ESB. For details, see “Generating the sample node error program” on page 499.

The common routines in the NEP provide common services for your own logic. They count and time stamp errors in the ESB, and test whether error thresholds have been exceeded. They are not documented outside the sample listings. You can generate a NEP without them if you prefer.

Your own code is inserted between the DFHSNEP TYPE=INITIAL and TYPE=FINAL macros.

**Note:** If the user code you insert between the DFHSNEP macros contains EXEC CICS commands, you must translate the commands, and enter the *translated code* between the DFHSNEP macros.

Each section of user logic, intended to handle a particular group of error types, is headed by a macro of the type:

```
DFHSNEP TYPE=ERRPROC, CODE=(ab,cd,...), GROUP=n
```

where X'ab', X'cd',... are the DFHZNAC internal error codes you want to process, and n is the number of the error group, and therefore also of the corresponding ESB, within a NEB, in the node error table. Successive DFHSNEP TYPE=ERRPROC macros should use groups 1, 2, 3, and so on.

The DFHSNEP TYPE=ERRPROC macros serve several purposes. They:

- Inform the NEP generation how many error groups there are
- Show which error types are to be included in each group
- Introduce the code for each group.

Note that any one DFHZNAC error code should only figure in one error group, and that any code not mentioned is simply ignored by the NEP. You follow each DFHSNEP TYPE=ERRPROC macro with your own logic. This should begin with standard code to save registers, or set up addressability, which is best copied from sample NEP listings.

CICS provides some standard error processors to handle specific errors on two different types of LU. These are for non-SNA 3270s (BSC 3270s attached to CICS-VTAM), and for interactive SNA logical units like a 3767. More information is given in “When an abnormal condition occurs” on page 486.

The code for non-SNA 3270s can be generated by coding

```
DFHSNEP TYPE=DEF3270
```

where you would otherwise code a DFHSNEP TYPE=ERRPROC macro plus logic of your own. In effect, TYPE=DEF3270 defines two error groups, and associates each with an error processor. The first group comprises the four DFHZNAC error codes X'D9', X'DC', X'DD', and X'F2'. The second group contains only error code X'42', corresponding to the ‘unavailable printer’ condition, a specific exception condition signaled when CICS cannot allocate a printer in response to a 3270 print request.

The 3270 sample code is not intended to cover all error conditions. Note that the code is not suitable for SNA 3270s (LU session type 2). Error conditions arising from these result in different DFHZNAC error codes and may require different handling.

You may find that the CICS-supplied code is not sufficient for other, application-related, reasons. Perhaps you want to try to reacquire lost sessions after a time interval. The code supplied for the 3767 covers only one error group with one DFHZNAC error code, X'DC', which may occur under contention protocol.

You can use these CICS-supplied error processors to generate a valid DFHZNEP listing, for tutorial purposes, without having to write any user code.

You should be aware of the following limitations of this NEP design:

- Any error types you have not allowed for are ignored by the NEP, and not accumulated into error buckets.
- You may want to handle a particular situation whenever it arises, even though DFHZNAC may assign it different error codes in different situations. For example, on an SNA 3270, switching in and out of TEST state generates status X'082B' (presentation-space integrity lost). This might result in one of several DFHZNAC error codes.

In the sample NEP structure, you would need either to test for this last case in separate error processors, or group all the DFHZNAC error codes together. If you wrote your own NEP code from scratch, you would simply, on entry to your NEP, test the communication area field containing the status.

## Multiple NEPs

CICS allows you to define a NEP transaction class that applies to every transaction that uses a particular profile, session, or terminal-type. To do this you use the NEPCCLASS option of the CEDA DEFINE PROFILE, CEDA DEFINE SESSIONS, or CEDA DEFINE TYPETERM command. (Note that any value of NEPCCLASS that you specify using CEDA DEFINE PROFILE overrides any specified using CEDA DEFINE SESSIONS or CEDA DEFINE TYPETERM.) NEPCCLASS is a 1-byte binary field containing a value in the range 0–255. The purpose of NEPCCLASS is that, while a transaction is running on the LU, you can obtain a special version of node error handling, suitable for that transaction. (This is sometimes called a “transaction-class error routine”.) The default value NEPCCLASS(0) indicates that no NEPCCLASS is in effect.

The DFHZNEP that gets control from DFHZNAC must test the NEPCCLASS in effect at that time for the LU associated with the error. Then it either transfers control to a suitable module (the actual NEP), or branches to a specific bit of code within itself.

The DFHZNEPI macros (see “DFHZNEPI macros” on page 508) generate a DFHZNEP module that is purely a routing module. This inspects the NEPCCLASS in effect for the node error passed by DFHZNAC, and transfers control (links) to another module, the real NEP, according to a NEPCCLASS/name routing table built up by the macros.

If no NEPCCLASS is in effect (equivalent to CEDA DEFINE PROFILE NEPCCLASS(0)), or the NEPCCLASS is not in the routing table, a default module is invoked. You must specify the name of this in the DFHZNEPI TYPE=INITIAL macro. (See “DFHZNEPI TYPE=INITIAL—specifying the default routine” on page 509.) If you do not specify the name, no module is invoked.

You also have to provide the sub-NEPs for the various NEP transaction classes, including, of course, one for the default NEPClass(0). Each of these sub-NEPs needs a separate program definition. You have the same choice in coding each sub-NEP as you had when there was just one; you can code your own, or use the CICS sample macro DFHSNEP. If you use DFHSNEP, note that there is another operand on the DFHSNEP TYPE=INITIAL macro, NAME=, which means that the generated module can be given any name you choose (to match the DFHZNEPI routing). You can use a different node error table with each sub-NEP.

Before you start using NEP routing, consider the following:

- The association of an LU (TCTTE) with a transaction NEPClass is only valid for about the time that the CICS task exists. Errors detected after a CICS task has ended (for example, because of a problem with a delayed output message) may not be associated with the NEPClass of the creating transaction.

Another problem can occur when CICS is about to start a new task for the LU as a result of an internal request from another CICS task (by an EXEC CICS START request, for example). This is usually called automatic transaction initiation. Before the task is started, CICS has to open a fresh session if none exists, by issuing a VTAM SIMLOGON request, and then, as mentioned earlier, send a BID command. The intended task is not attached until all this is completed successfully. The NEPClass is not picked up from the transaction definition until then. This means that any errors arising in the ATI process (perhaps an error on BIND or BID) occur before the NEPClass is correctly set, so they may get routed to the default NEP and not the one for the NEPClass. This complicates the total node error handling for the application.

As an example, consider an application that contacts unattended programmable controllers overnight in order to read in the day's input. Recovery design in such an application is fundamental, and has to allow for errors both in ATI and in file transmission. To separate these into two NEPs could be an unnecessary complication.

- The extra development effort for a NEP split on a NEPClass basis might not be justified. Generally, if logic is to be split, it is on an LU basis (programmable controllers may be running applications other than 3270).

To conclude this overview, remember that the CICS sample NEPs are a good source of ideas for you to write your own NEPs, but they might not be the ideal framework for your particular needs. It is recommended that you write straightforward NEPs at first.

---

## When an abnormal condition occurs

The following CICS components are involved when an abnormal condition is detected from a logical unit:

- The terminal control program VTAM section: DFHZCA, DFHZCB, DFHZCC, DFHZCP, DFHZCQ, DFHZCW, DFHZCX, DFHZCY, and DFHZCZ.
- The node abnormal condition program, DFHZNAC.
- The CICS-supplied default node error program, DFHZNEP, or your own version of it.

For logical units, all information concerning the processing state of the terminal is contained in the TCTTE and the request parameter list (RPL). Consequently, when a terminal error must be handled for a logical unit, the TCTTE itself is placed onto the system error queue.

DFHZNAC assumes that system sense codes are available upon receipt of an exception response from the logical unit. Thus, analysis is performed to determine the reason for the response. Decisions, such as which action flags to set and which requests are needed, are made based upon the system sense codes received. If sense information is not available, default action flags are set, and DFHZEMW is scheduled to send a negative response, if a response is outstanding, with an error message to the terminal.

The action flags set by DFHZNAC on receipt of specific inbound system sense codes are listed in Appendix B, "Default actions of the node abnormal condition program," on page 855.

Before executing the specified routines, DFHZNAC links to DFHZNEP. You can use DFHZNEP to perform additional error processing beyond that performed by DFHZNAC; or to alter the default actions previously set by DFHZNAC. You need to code a node error program only if you want to do either of these things.

The action flags, set by DFHZNAC to assist the node error program, are in field TWAOPTL of the communication area.

If you want to modify DFHZNAC's actions following an abnormal situation, DFHZNEP can interrogate field TWAOPTL and modify the bit settings. If you agree with DFHZNAC's proposed actions, field TWAOPTL is left unaltered.

In most cases, DFHZNEP can modify DFHZNAC's proposed actions. The only time that DFHZNAC overrides DFHZNEP's modification of field TWAOPTL is when a logical unit is to be disconnected from CICS; that is, when DFHZNAC determines that the abnormal situation requires that CICS issue the ACF/VTAM CLSDST macro for a logical unit. In such a case, DFHZNAC disconnects the terminal and abnormally terminates the task, even if DFHZNEP tries to block such actions.

Resetting of the task termination flag by the node error program is also ignored if a negative response has been sent to a logical unit, or if DFHZEMW is to write an error message to the logical unit.

When the node error program has performed its functions, it returns control to DFHZNAC by an EXEC CICS RETURN command.

When control is returned from DFHZNEP, DFHZNAC performs the actions specified in field TWAOPTL (except when disconnecting logical units, as noted above), issuing messages and setting error codes, as necessary.

## The communication area

After DFHZNEP receives control from DFHZNAC, it obtains the address of the communication area by means of an EXEC CICS ADDRESS COMMAREA command. Figure 30 on page 488 illustrates the general structure of the communication area.

Header
Error_being_processed
User option bytes
VTAM information
Additional information for NEP
Additional system parameters
XRF parameters

Figure 30. General structure of the communication area

The significance of each section of the communication area is described below:

**Header**

A 4-byte header common to all user-replaceable programs.

**Error\_being\_processed**

Identifiers of the error code and the terminal associated with the error.

**User option bytes**

Flags that indicate the default actions set by DFHZNAC, and that may be reset within DFHZNEP.

**VTAM information**

Sense and RPL codes.

**Additional info. for NEP**

Other useful information for the NEP.

**Additional system parameters**

Locations of indirect parameters, such as the TCTTE, and other system information.

**XRF parameters**

Recovery notification data.

A detailed listing of the communication area is given in Figure 31 on page 489.

```

*****
**                               Header                               **
**       These fields are READ ONLY                               **
*****
NEPCAHDR DS   0XL4                Standard Header
NEPCAFNC DS   XL1                  Function Code      Always '1'
NEPCACMP DS   XL2                  Component Code    Always 'ZC'
           DS   XL1                  Reserved
*****
**                               Error_being_processed            **
** Identity of terminal and the error code associated with it    **
**       These fields are READ ONLY                               **
*****
TWAEC   DS   XL1                Error Code
           DS   CL3                Reserved
TWANID  DS   CL4                Terminal identity
TWANETN DS   CL8                Netname
*****
**                               User option bytes                **
**       Initially set to the default actions.                    **
**       DFHZNEP can change the defaults.                        **
*****
TWAOPTL DS   0XL3                User option bytes
TWAOPT1 DS   XL1                User option byte 1
TWAOPT2 DS   XL1                User option byte 2
TWAOPT3 DS   XL1                User option byte 3
           DS   XL1                Reserved

```

Figure 31. The DFHZNAC/DFHZNEP communication area (part 1)

```

*****
**      VTAM information - Any VTAM sense and RPL codes      **
**      These fields are READ ONLY                          **
*****
TWAVTAM DS  0XL12      VTAM information
TWARPLCD DS  H         VTAM RPL feedback codes
          DS  H         Reserved
TWASENSS DS  0F        Sense codes to be sent
TWASS1   DS  XL1      System sense byte No 1
TWASS2   DS  XL1      System sense byte No 2
TWAUS1   DS  XL1      User sense byte No 1
TWAUS2   DS  XL1      User sense byte No 2
*
TWASENSR DS  0F        Sense codes received
TWASR1   DS  X        System sense byte No 1
TWASR2   DS  X        System sense byte No 2
TWAUR1   DS  X        User sense byte No 1
TWAUR2   DS  X        User sense byte No 2
*
*****
**      Additional information for the NEP                    **
**Except for TWANPFW, TWANLD, and TWANLDL these fields are READ ONLY**
*****
TWAADINF DS  0XL22
          DS  F         Reserved
TWACTLB  DS  X         General use control byte
*        EQU  X'80'    Reserved
*        EQU  X'40'    Reserved
TWACSC   EQU  X'20'    Clear sense code indicator
TWAPSC   EQU  X'10'    Print VTAM sense codes
TWATIOA  EQU  X'08'    Print portion of I/O area
*        EQU  X'04'    Reserved
TWAVTRTC EQU  X'02'    VTAM return code available
TWANEPR  DS  XL1      NEP return code byte
TWANPFW  EQU  X'80'    Retry write with FORCE=YES
TWAREASN DS  XL1      VTAM reason code
TWASTAT  DS  XL1      VTAM status code
TWATRSN  DS  XL1      CICS terminal control
*        terminal error code
TWAXRSN  DS  H         Exception response seq number recd
TWAR     EQU  *
TWAPFLG  DS  XL1      CLSDST pass flag
TWAPIP   EQU  X'80'    CLSDST pass in progress
TWANEP   DS  XL1      NEP class flag
TWAEISAB DS  XL1      Stand-alone begin bracket indicator
TWAESAB  EQU  X'04'    Stand-alone begin bracket
          DS  XL3      Reserved
TWANLD   DS  A         Address of data to be logged
TWANLDL  DS  H         Length of data to be logged

```

Figure 32. The DFHZNAC/DFHZNEP communication area (part 2)



```

*****
**                Additional system parameters                **
**Except for TWAPNETN, TWAPNTID, TWAUPRRRC these fields are READ ONLY**
*****
TWASYSM DS      0XL68
TWATCTA DS      AL4                Address of TCTTE being processed
TWARPL  DS      AL4                Address of VTAM RPL
TWATIOAA DS     AL4                Address of data portion of TIOA
TWATIOAL DS     H                  Length of data portion of TIOA
TWACOMML DS     H                  Length of commarea data for TCTTE
TWACOMMA DS     CL4                Address of commarea data for TCTTE
TWATECIA DS     AL4                Address of TCTTE user area
TWATECIL DS     H                  Length of TCTTE user area
TWAPPNTN DS     CL8                Primary 3270 printer netname
TWAPPTID DS     CL4                Primary 3270 printer termid
TWAPPELG DS     X                  Primary printer eligible indicator
TWAPPELY EQU    X'01'              Primary printer is eligible flag
TWASPNTN DS     CL8                Secondary 3270 printer netname
TWASPTID DS     CL4                Secondary 3270 printer termid
TWASPELG DS     X                  Secondary printer eligible indicator
TWASPELY EQU    X'01'              Secondary printer is eligible flag
TWAPNETN DS     CL8                Selected 3270 printer netname
TWAPNTID DS     CL4                Selected 3270 printer termid
TWAUPRRC DS     B                  Unavailable Printer return code
TWAUPRNP EQU    X'00'              No printer selected
TWAUPRPS EQU    X'01'              Printer selected
TWAUPRDD EQU    X'FF'              Data disposal complete
TWAUPRPE EQU    X'FE'              Error on Put request
TWAERRF1 DS     B                  Error flag byte 1
TWALXS  EQU     X'80'              Logon crossed simlogon
          DS     XL2                Reserved
*****
**                XRF parameters                            **
**                XRF recovery notification data            **
**                DFHZNEP can change these default actions  **
*****
TWXRNOT DS     X                  Recovery notification options
TWXRNON EQU    X'80'              Recov notification = none
TWXRMSG EQU    X'40'              Recov notification = message
TWXRTRN EQU    X'20'              Recov notification = transact.
          DS     XL3                Reserved
TWAXMSTN DS     CL8                Recovery mapset name
TWAXMAPN DS     CL8                Recovery map name
TWAXTRAN DS     CL4                Recovery transaction ID
*

```

Figure 33. The DFHZNAC/DFHZNEP communication area (part 3)

The next sections describe fields in the parameter list that can be reset within DFHZNEP. See also “Coding for the 3270 ‘unavailable printer’ condition” on page 506, which describes the use of the flags in the “unavailable printer return code” field, and “Using the node error program with XRF or persistent sessions” on page 510, which describes how the flags in the XRF part of the parameter list can be manipulated.

## The user option bytes (TWAOPTL)

TWAOPTL contains the user option bytes TWAOPT1, TWAOPT2, and TWAOPT3, each of which contains action flags. On entry to DFHZNEP, these flags represent the default actions previously set by DFHZNAC. They can be reset by DFHZNEP.

### TWAOPT1

User option byte 1. TWAOPT1 contains flags which are principally debugging aids. The first five flags cause DFHZNAC to write the desired information to the CSNE log if the appropriate bit is set. Setting the sixth flag (TWAODNTA) on

causes CICS to take a system dump when there is no task attached to the terminal at the time of error detection, if the flag TWAOAT in TWAOPT2 is also set on. Setting the TWAONQN flag causes the network qualified name to be printed after any message that contains the action flag. Similarly setting the TWAOTNA flag causes the TNADDR information to be printed.

The flags are:

**TWAOAF (X'80')**

Print action flags.

**TWAORPL (X'40')**

Print VTAM RPL.

**TWAOTCTE (X'20')**

Print TCTTE.

**TWAOTIOA (X'10')**

Print TIOA.

**TWAOBIND (X'08')**

Print BIND area.

**TWAODNTA (X'04')**

System dump if no task attached.

**TWAONQN (X'02')**

Print NQNAME.

**TWAOTNA (X'01')**

Print TNADDR (TCP/IP client address, port and, optionally, host name).

**Note:**

1. Note that DFHZC2411 is not related to a specific node—that is, the TCTTE has not yet been created, and the message is printed against a dummy TCTTE. The node error program is not called in this case, therefore the default setting cannot be overridden. This means that the NQNAME and the TNADDR information is always printed for DFHZC2411 messages.
2. When DFHZC2410 is issued against the dummy TCTTE, the NQNAME and TNADDR are not printed.

**TWAOPT2**

User option byte 2. TWAOPT2 contains flags which are task-related.

The NEP can abend the task by setting TWAOAT, or cancel it by setting TWAOCT. The difference is that abend task does not take effect until the task requests or completes a terminal control operation: cancel task takes effect as soon as system and data integrity can be maintained. Setting TWAOAT to abend the task is normally sufficient, except where the task performs lengthy processing (such as a database browse) between terminal requests. If both TWAOAT and TWAOCT are set, TWAOCT (cancel task) takes priority.

If the task is to be abnormally terminated, sends and receives are purged. If TWAOGMM is set, the next transid is cleared and any communication area associated with the terminal is released—except in the case of permanent transids (specified on the TERMINAL definition as TRANSACTION(name)), when the communication area is not released. If the TYPETERM of the terminal indicates that the “good morning” message is supported (LOGONMSG(YES)), if TWAONINT is off, and if the terminal is not in a BMS paging session, then the

“good morning” message transaction is initiated (the transaction specified by the system initialization parameter GMTRAN).

The flags are:

**TWAOAS (X'80')**

Abandon any SEND for this terminal

**TWAOAR (X'40')**

Abandon any RECEIVE for this terminal

**TWAOAT (X'20')**

Abend any task attached to TCTTE

**TWAOCT (X'10')**

Cancel any task attached to TCTTE

**TWAOGMM (X'08')**

“good morning” message to be sent

**TWAOPBP (X'04')**

Purge any BMS pages for this session

**TWAOASM (X'02')**

SIMLOGON required.

**Note:**

1. If a definite response SEND has been performed, CICS has to issue a RECEIVE in order to obtain the response. If the response is negative, DFHZNAC is entered and sets flags TWAOAS (abandon the SEND) and TWAOAR (abandon the RECEIVE). TWAOAR must be left on to ensure that the RECEIVE for the response is abandoned.
2. If the request is to be retried, and the break connection action flag is off (that is, if TWAOCN in TWAOPT3 is off), then one or more of TWAOAS, TWAOAR, and TWAONEGR must be off as well as TWAOAT.
3. The abend code returned as a result of setting TWAOCT is unpredictable.
4. TWAOGMM forces TWAOAT only if set on by the node error program.
5. TWAOPBP forces TWAOAT to be set on.
6. For non-pipeline terminals, TWAOAT acts as a cancel request (TWAOCT) if the task has not yet been dispatched for the first time.

**TWAOPT3**

User option byte 3. TWAOPT3 contains flags which are node-related.

The flags are:

**TWAOINT (X'80')**

Internally generated logons (INTLOGs) allowed

**TWAONINT (X'40')**

No internally-generated logons allowed. Do not set this flag when processing error code X'49' (TCZCLSIN)

---

2. Do not set this flag when processing error code X'49' (TCZCLSIN).

**TWAONCN (X'10')**

Normal CLSDST (no reset allowed)

**TWAOSCN (X'08')**

Normal CLSDST (reset allowed)

**TWAONEGR (X'04')**

Send negative response

**TWAOOS (X'02')**

Keep node out of service

**TWAOCN (X'01')**

CLSDST node. Do not set this flag when processing error code X'49' (TCZCL SIN).

TWAOININT forces TWAOCN.

TWAOONEGR forces TWAOAR and TWAOAT.

TWAOOS forces TWAOCN.

TWAOCN forces TWAOAR, TWAOAS, and TWAOAT.

TWAOOS indicates that no further processing is to be done for this node. The node is logically out of service.

For an LU6.1 intersystem communication session, TWAOOS or TWAOININT causes the system entry to be put out of service if, as a result of the specified action, there are no allocatable sessions left. (A session can also be put out of service because of either an unknown modename being passed to VTAM during an attempt to bind an APPC session, or an invalid logmode name for a VTAM 3270-type terminal. However, the CICS default action resulting from this condition cannot be overridden in the NEP.)

If TWAOCN is set, the task is abnormally terminated and communication with the node is lost. Note that the NEP cannot reset this flag.

TWAOOSCN provides the same function as TWAONCN, but the NEP can reset it if the session is not to be closed.

If DFHZNAC is scheduled because of the receipt of an exception response, the sense information in the TCTTE is available to DFHZNAC and DFHZNEP to determine any necessary actions.

If DFHZNAC is scheduled because of loss of the connection between CICS and a logical unit, DFHZNAC abnormally terminates any transaction in progress at the time of the failure. DFHZNEP and transaction-class error routine analysis and processing are permitted, but you should not attempt to retry the message.

However, if the application program handles the 'TERMERR' condition, the transaction is not abended. Control is returned to the program. In this circumstance, no further use can be made of the failed session.

**Additional information for the NEP (TWAADINF)**

Fields TWANPFW, TWANLD, and TWANLDL can be reset by the NEP. For information about the use of TWANPFW, see the supplied sample node error program, and "Optional error processor for interactive logical units" on page 499.

***TWANLD and TWANLDL — using the DFHZNAC logging facility:***

You can use the logging facility available in DFHZNAC to aid in retrieving information. You specify the address of the data that you want to examine in field

TWANLD of the communication area, and the length of the data in field TWANLDL. The data is logged to the CSNE transient data queue for future inspection.

**Note:** No data in excess of 220 bytes is logged.

You can also send user-written messages to the CSNE log using the transient data facility. To write your messages, you must code the EXEC CICS WRITEQ TD instruction directly into the node error program.

### ***TWAPIP — and application routing failure:***

The EXEC CICS ISSUE PASS command passes control from CICS to another named VTAM application. For programming information about the EXEC CICS ISSUE PASS command, see ISSUE PASS, in the *CICS Application Programming Reference* manual. The ISSUE PASS command in turn invokes the VTAM macro CLSDST with OPTCD=PASS, and, in addition, if NOTIFY has been specified on the CLSDSTP system initialization parameter, with PARMS=(THRDPTY=NOTIFY). CICS is then notified of the outcome of any CLSDST request.

This notification results in an informative message being issued, and causes DFHZNAC to invoke your NEP, whether the CLSDST request has failed or succeeded. The NEP can discover that a CLSDST OPTCD=PASS request is in progress by examining field TWAPFLG for the pass-in-progress indicator, TWAPIP. The success or failure of the CLSDST OPTCD=PASS request can be determined by examining the error code at TWAEC.

If the pass operation fails, DFHZNAC sets up a default set of recovery actions that can be modified by your NEP. A possible recovery, when, for example, the target application program is not active, would be to reestablish the session with the initial application using a SIMLOGON request and for CICS to send its “good morning” message to the terminal. The default action is to leave the session disconnected and to make it NOCREATE.

If CLSDSTP=NONOTIFY has been specified, and autoinstall is being used, CICS takes no action, even if the ISSUE PASS fails.

If persistent sessions support is active, autoinstall terminals are deleted after the AIRDELAY, so any expected NEP processing as a result of CLSDSTP=NOTIFY being coded does not take place.

### **The additional system parameters (TWASYSPPM)**

If a data element referenced in this section of the parameter list (for example, the TIOA) does not exist when the NEP is driven, its address and length fields are set to zero.

Fields TWAPNETN, TWAPNTID, and TWAUPRRRC can be reset by the NEP. The use of these fields is discussed in “Data storage key for task-related user exit programs” on page 290.

### **XRF parameters (TWAXRNOT)**

These fields can be reset by the NEP. See “Using the node error program with XRF or persistent sessions” on page 510.

---

## The sample node error program

The sample node error program provides a general environment for the execution of error processing routines (error processors), each of which is specific to certain error codes generated by the node abnormal condition program. Sufficient optional error processors for normal operation of VTAM 3270 or interactive logical unit networks are provided; these can be easily supplemented or replaced by user-supplied error processors.

There are three types of error that may occur in a VTAM network:

- Errors in the host system
- Communication errors, such as session failures
- Abnormal conditions at the terminal, such as intervention required and invalid requests.

A sample node error program is supplied with CICS, and can be used as the basis of each subsequent node error program that you write. This provides you with:

- A general environment within which your error processing programs can be added
- The default node error program in a system that has several node error programs.

The CICS-supplied sample node error program is described in greater detail below.

## Compatibility with the sample terminal error program

Receipt of sense or status codes corresponds to error codes X'D9', X'DC', X'DD', and X'F2'. Weighted counts of these messages are maintained against numeric and time thresholds. If the numeric threshold is exceeded, default actions are taken. If the time threshold is reached, the count is reset. This is equivalent to the function in the sample TEP, except that sense or status arising out of the “from” device on a COPY command is now presented to the node error program as an error on the “to” device; this causes the threshold to be exceeded, resulting in the request being terminated, although the terminal remains in service. Some of the weights for errors that occur on the 3270 display device have been revised, but otherwise the weight and threshold values are the same as the defaults used in the sample TEP. Time threshold maintenance for the sample NEP is mandatory, and not optional as in the sample TEP.

For further information about time and threshold count limits, see the information about the sample terminal error program in Chapter 8, “Writing a terminal error program,” on page 449.

The 3270 message ‘unavailable printer’ corresponds to error code X'42' (interval control PUT request has failed). The algorithm used for printer selection differs in VTAM support. The retry algorithm in the sample node error program is similar to this new selection algorithm.

## Components of the sample node error program

The sample node error program comprises the following components:

- An entry section.
- The routing mechanism.
- The node error table.
- Optional common subroutines.

- Optional error processors for 3270 or interactive logical units. A node error program cannot be generated with both 3270 and interactive logical unit error processors.

The components are described in the sections that follow.

### **Entry section**

On entry, the sample NEP uses DFHEIENT to establish base registers and addressability to the EXEC interface. It uses an EXEC CICS LOAD PROGRAM command to establish addressability to the node error table (NET) and, if included, the common subroutine vector table (CSVTV). It uses an EXEC CICS ADDRESS COMMAREA command to obtain addressability to the communication area passed by DFHZNAC, and an EXEC CICS ADDRESS EIB command to obtain addressability to the EXEC interface block. If time support has been generated, the error is time-stamped for subsequent processing.

### **Routing mechanism**

The routing mechanism invokes the appropriate error processor depending on the error code provided by the node abnormal condition program.

Groups of one or more error codes are defined in the DFHSNEP macro (see below). Each group is associated with an index (in the range X'01' through X'FF') and an error processor. A translate table is generated and the group index is placed at the appropriate offset for each error code. Error codes not defined in groups have a zero value in the table. An error processor vector table (EPVT) contains the addresses of the error group processors, positioned according to their indexes. The vector table extends up to the maximum index defined; undefined intermediate values are represented by zero addresses.

The error code is translated to obtain the error group index. A zero value causes the node error program to take no further action; otherwise the index is used to obtain the address of the appropriate error processor from the EPVT. A zero address causes the node error program to take no further action; otherwise a call is made to the error processor. This is entered with direct addressability to the NET and CSVTV areas. When the error processor has been executed, the node error program returns control to the node abnormal condition program.

### **Node error table**

The node error program may use a node error table (NET) that comprises the node error blocks (NEBs) used to maintain error status information for individual nodes (see Figure 34 on page 498). Some or all of the NEBs can be permanently reserved for specific nodes; others are dynamically assigned to nodes when errors occur. Dynamically assigned NEBs are used exclusively for the nodes to which they are assigned until they are explicitly released. All the NEBs have an identical structure of error status blocks (ESBs). Each ESB is reserved for one error processor and associated with it by means of the appropriate error group index. The ESB length and format can be customized to the particular error processor that it serves.

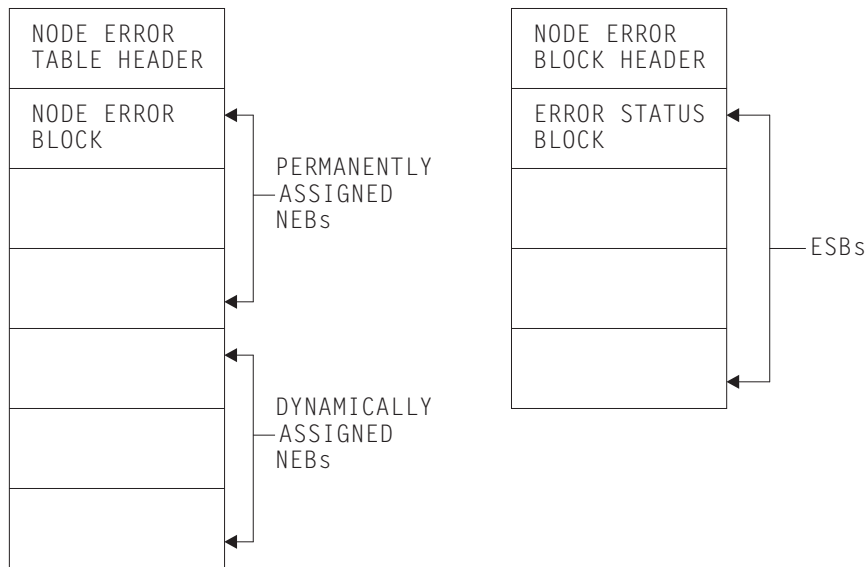

Figure 34. Format of node error table and node error block

### Optional common subroutines

The common subroutines are addressed via the CSVT and provide error processors with the following functions:

- Locate or assign NEBs and ESBs on the basis of node ID and error group index.
- Time stamp an error, update an error count, and test an error count against numeric and time threshold values.
- Release a dynamically assigned NEB from a particular node.

### Optional error processors for 3270 logical units

Two error processors are supplied for 3270 LUs, as follows:

1. Group index 1, error codes X'D9', X'DC', X'DD', and X'F2'.

These error codes correspond to the receipt of sense or status bytes in the user sense fields of the RPL. The error processor locates an ESB of the standard format and updates a weighted error count. The weight, threshold, and timer values are based on those used by the sample terminal error program 3270 except as noted in the previous section. If the threshold is not exceeded, the abend SEND, abend RECEIVE, abend transaction flags, and all the print action flags are turned off. Otherwise the default actions are taken and the NEB is released if it is reusable.

2. Group index 2, error code X'42'.

This code means that no 3270 printer was available to satisfy a print request made at a 3270 screen. The error processor examines the printers defined for this screen to determine why they were unavailable. If either is busy on a previous PRINT or COPY request (that is, a task is attached with a transaction ID of CSPP or CSCY) or is no longer unavailable, that printer address is returned to the node abnormal condition program which retries the print request with an IC PUT command. Otherwise the default actions are taken. (For more details, see the section "Coding for the 3270 'unavailable printer' condition" on page 506.)



## Optional error processor for interactive logical units

Only one error processor is supplied for interactive LUs: group index 1, with error code X'DC'.

This error code, in combination with a user sense value of X'081B', indicates a 'receiver in transmit mode' condition. The action flags in TWANPFW are manipulated to allow the failing SEND request to be retried.

## Generating the sample node error program

The routing mechanism, common subroutines, CICS-supplied error processors, and user-supplied error processors are generated by means of DFHSNEP macros.

The sample node error program and table need to be translated, assembled, and link-edited. For information about the job control statements required to assemble and link-edit user-replaceable programs, refer to "Assembling and link-editing user-replaceable programs" on page 436.

Note that you should code the translator options NOPROLOG and NOEPILOG in your node error program.

Note also that an extra 24 bytes are required for the common subroutines register save area, and further space is required for the error processor save area. The CICS sample processors use 4 bytes of this area.

The DFHSNEP macro to generate the sample node error program has seven types, as follows:

**TYPE=USTOR**

to indicate the start of user storage definitions.

**TYPE=USTOREND**

to indicate the end of user storage definitions.

**TYPE=INITIAL**

to generate the routing mechanism and, optionally, the common subroutines.

**TYPE=DEF3270**

to generate the default CICS-supplied error processors for 3270 devices.

**TYPE=DEFILU**

to generate the default CICS-supplied error processor for interactive logical units operating in contention mode.

**TYPE=ERRPROC**

to indicate the start of a user-supplied error processor.

**TYPE=FINAL**

to indicate the end of the sample node error program.

### DFHSNEP TYPE=USTOR and USTOREND—defining user storage

The DFHSNEP TYPE=USTOR macro has the following format:

This macro indicates the start of user storage definitions. It must be followed by

```
DFHSNEP TYPE=USTOR
```

your storage definitions, and then by DFHSNEP TYPE=USTOREND. If you use

DFHSNEP TYPE=USTOR to define storage, then both it and DFHSNEP TYPE=USTOREND must be coded **before** DFHSNEP TYPE=INITIAL.

The DFHSNEP TYPE=USTOREND macro has the following format:  
This macro indicates the end of user storage definitions. Its use is mandatory if

```
DFHSNEP TYPE=USTOREND
```

DFHSNEP TYPE=USTOR has been coded. If you use DFHSNEP TYPE=USTOR to define storage, then both it and DFHSNEP TYPE=USTOREND must be coded **before** DFHSNEP TYPE=INITIAL.

### **DFHSNEP TYPE=INITIAL—generating the routing mechanism**

One DFHSNEP TYPE=INITIAL macro must appear immediately **after** DFHSNEP TYPE=USTOR and DFHSNEP TYPE=USTOREND (if they are coded) and **before** the remaining macros.

```
DFHSNEP TYPE=INITIAL  
      [,CS=NO]  
      [,NAME=name]  
      [,NETNAME=netname]
```

#### **TYPE=INITIAL**

indicates the start of the sample node error program and causes the routing mechanism to be generated.

#### **CS=NO**

specifies that the generation of the common subroutines is to be suppressed.

#### **NAME=name**

specifies the name of the node error program module identifier. The name must be a string of 1 through 8 characters. This operand is optional, and the default is DFHZNEP0. If you allow the NAME operand to default, you can use the examples in Link-edit statements for DFHTEP and DFHZNEP to create link-edit statements, but if you specify a different NAME, you must change the link-edit statements accordingly. If the interface module DFHZNEP (generated by the DFHZNEPI macro) is used, this operand must be specified (with a name other than DFHZNEP).

#### **NETNAME=netname**

specifies the name of the node error table to be loaded at initialization. The name must be a string of 1 through 8 characters. This operand is optional, and the default is DFHNET.

### **DFHSNEP TYPE=DEF3270—including error processors for 3270 LUs**

The DFHSNEP TYPE=DEF3270 macro has the following format:

```
DFHSNEP TYPE=DEF3270
```

#### **TYPE=DEF3270**

specifies that the CICS-supplied error processors for 3270 logical units are to be included in the node error program. This macro causes the following source code to be generated:

DFHSNEP TYPE=ERRPROC,GROUP=1,CODE=(D9,DC,DD,F2)  
Sense/status error processor code.

DFHSNEP TYPE=ERRPROC,GROUP=2,CODE=42  
Unavailable printer error processor code.

## DFHSNEP TYPE=DEFILU—including error processors for INTLUs

The DFHSNEP TYPE=DEFILU macro has the following format:

```
DFHSNEP TYPE=DEFILU
```

### TYPE=DEFILU

specifies that the CICS-supplied error processor for interactive logical units is to be included in the node error program. This macro causes the following source code to be generated:

```
DFHSNEP TYPE=ERRPROC,GROUP=1,CODE=DC  
(receiver in transmit mode error processor code)
```

## DFHSNEP TYPE=FINAL—terminating DFHSNEP entries

One DFHSNEP TYPE=FINAL macro must follow all the other DFHSNEP macros. It has the following format:

```
DFHSNEP TYPE=FINAL
```

### TYPE=FINAL

indicates the end of the node error program and causes the error processor vector table (EPVT) to be generated.

## DFHSNEP TYPE=ERRPROC—specifying a user error processor

The DFHSNEP TYPE=ERRPROC macro is used to indicate the start of a user-supplied error processor. The actual error processor code should immediately follow this macro. The assembly should be terminated by the statement END DFHNEPNA.

The following operands can be used on the DFHSNEP TYPE=ERRPROC macro:

```
DFHSNEP TYPE=ERRPROC  
,CODE=(error-code,...)  
,GROUP=error-group-index
```

### TYPE=ERRPROC

indicates the start of a user-supplied error processor.

### CODE=(error-code,...)

specifies the error codes that make up the error group, and which are therefore handled by the error processor supplied. The operand is coded as a sublist of 2-character representations of 1-byte hexadecimal codes. (The parentheses can be omitted for a single code.) For each code specified, the error group index is placed at the equivalent offset in the translate table. Thus, when this code occurs, the appropriate error processor can be identified.

### GROUP=error-group-index

specifies an error group index for the error processor. This index is used to name the error processor, locate its address from the error processor vector table (EPVT), and optionally associate it with an ESB in each NEB. The index specified must be a 2-character representation of a 1-byte hexadecimal number

in the range X'01' through X'FF' (a leading zero can be omitted). The error processor name has the form NEPROCxx, where “xx” is the error group index. A CSECT statement of this name is generated, which causes the error processor code to be assembled at the end of the node error program module and to have its own addressability.

If you intend to add your own error processors to the sample node error program, you should consider the following factors:

- The layout of the communication area. The communication area is described in detail in Figure 31 on page 489.
- The fact that certain functions cannot be used within DFHZNEP. (See “Restrictions on the use of EXEC CICS commands” on page 505.)
- The register conventions used by the sample node error program. These are described in Table 25.

*Table 25. Register assignment*

<b>Register</b>	<b>Use</b>
0	Work register
1	Address of the EXEC parameter list
2	NEB base register (DFHSNEP only)
3	ESB base register (DFHSNEP only) NEP error class register (DFHZNEPI only)
4	NEP name pointer register (DFHZNEPI only)
5	NEP interface base register (DFHZNEPI only)
6	Work register
7	Work register
8	Work register
9	Work register
10	Code base register
11	Address of the EIB
12	Address of the communication area
13	Address of DFHEISTG storage
14	CSVT base and error processor link register Common subroutine link register
15	Error processor branch register Common subroutine branch register.

**Note:**

1. Register 14 must be saved for return from error processors. The common subroutine vector table (CSVT) is coded after the BALR to the error processor and so this register is also the CSVT base.
2. Registers 1, 10, 12, 13, 14, and 15 are set up on entry to error processors.
3. Registers 14 through 11 can be saved by error processors in an area reserved in EXEC interface storage at label NEPEPRS. Registers 15 through 11 do not need to be restored before return from error processors.

4. Registers 4 through 9 can be saved by common subroutines in an area reserved in EXEC interface storage at label NEPCSRs. They must be restored before return from the subroutines.

## DFHSNET—generating the node error table

The DFHSNET macro is used to generate a node error table. Each node error table that you generate must be defined to CICS.

```
DFHSNET [NAME=DFHNET|name]
        [,COUNT=100|threshold]
        [,ESBS=1|(index,length,...)]
        [,NEBNAME=(name,...)]
        [,NEBS=10|number]
        [,TIME=(7,MIN)|(interval,units)]
```

### NAME=DFHNET|name

specifies the identifier to be included in the NET header. It must be a string of one through eight characters. This operand is optional, and the default is DFHNET.

### COUNT=100|threshold

specifies the error count threshold that is to be stored in the NET header for use by the common subroutines to update standard ESBs. If the threshold is exceeded, the error processor that invoked the subroutine is informed by a return code. The maximum value is 32 767. This operand is optional, and the default is 100.

### ESBS=1|(index,length,...)

specifies the ESB structure for each NEB. This operand is coded as a sublist. Each element of the sublist comprises two values: “index” specifies an error group index for which an ESB is to be included in the NEB; “length” specifies the status area length, in bytes, for that ESB. The parentheses can be omitted for a single element. The “index” must be specified as a 2-character representation of a 1-byte hexadecimal number in the range X'01' through X'FF' (a leading 0 can be omitted). The “length” is constrained only because an 8-byte NEB header plus a 4-byte header for each ESB must be contained within the maximum NEB length of 32 767 bytes. If a null value is specified, a standard ESB with a status area length of 10 bytes is assumed. This is suitable for use by the common subroutines in maintaining a time-stamped error count.

This operand is optional and defaults to 1. This causes each NEB to be generated with one ESB for error group 1 with a status area length of 6 bytes.

### NEBNAME=(name,...)

specifies the names of nodes that are to have a permanently assigned NEB. The names specified are assigned, in the order specified, to the set of NEBs requested by the NEBS operand. Any remaining NEBs are available for dynamic allocation to other nodes as errors occur. The name must be a string of 1 through 4 characters. The parentheses can be omitted for a single name. This operand is optional and has no default.

### NEBS=10|number

specifies the number of NEBs required in the NET. The maximum valid number is 32 767; the default is 10.

### TIME=(7,MIN)|(interval,units)

specifies the time interval that is to be stored in the NET header for use by the common subroutines to maintain error counts in standard ESBs. If the threshold

specified in the COUNT operand is not exceeded before this time interval elapses, the error count is reset to 0. Specify “units” as SEC, MIN, or HRS. The maximum values for “interval” are as follows: (86400,SEC), (1440,MIN), or (24,HRS). This operand is optional, and the default is set to (7,MIN).

## DSECTs

The following DSECTs are provided:

**Node Error Table Header:** This contains the table name and common information relevant for all the node error blocks (NEBs) in the table.

DFHNETH	DSECT		
NETHNAM	DS	CL8	Table name
NETHNBN	DS	H	Number of NEBs in table
NETHNBL	DS	H	Length of NEBs in table
NETHTIM	DS	PL8	Error count time interval
NETHECT	DS	H	Error count threshold
NETHFLG	DS	X	Flag byte
NETHINI	EQU	X'01'	Table initialized
	DS	X	Reserved
NETHFNB	DS	0F	First NEB

**Node Error Block:** The table contains node error blocks that are used for recording error information for individual nodes. These can be permanently assigned to specific nodes or dynamically assigned at the request of error processors.

DFHNETB	DSECT		
NEBNAM	DS	CL4	Node name
NEBFLG	DS	X	Flag byte
NEBPERM	EQU	X'01'	Permanently assigned NEB
	DS	XL3	Reserved
NEBFESB	DS	0X	First NEB

**Error Status Block:** The NEBs can contain error status blocks. These are reserved for specific error processors and are identified by the corresponding error group index. An ESB can have a format defined by you, or can have a standard format suitable for counting errors over a fixed time interval.

DFHNETE	DSECT		
ESBEGI	DS	X	Error group index
ESBFLG	DS	X	Flag byte
ESBSTAN	EQU	X'01'	Standard format ESB
ESBTTE	EQU	X'02'	Time threshold exceeded
ESBCTE	EQU	X'04'	Count threshold exceeded
ESBSLEN	DS	XL2	Status area length
ESBLEN	EQU	*-DFHNETE	ESB header length
ESBSTAT	DS	0X	Status area

The following fields apply to the standard format:

ESBTIM	DS	PL8	Time stamp
ESBEC	DS	XL2	Error count

**Common Subroutine Vector Table:** The CSVT provides error processors with addressability to the common subroutines. The error processor link register gives addressability to the CSVT and so the first section of the DSECT overlies the code required to branch around the actual table.

DFHNEPC	DSECT		
	DS	F	Load instruction
	DS	F	Branch instruction
CSVTNPEP	DS	A	Node error program base address

CSVTESBL	DS	A	NEPESBL - ESB locate routine
CSVTNEBD	DS	A	NEPNEBD - NEB delete routine
CSVTECUP	DS	A	NEPECUP - error count update routine

## Writing your own node error program

You can write your own NEP in any of the CICS-supported languages. However, CICS-supplied NEP code is provided in assembler language only. The communication area parameter list is supplied in assembler-language and C versions. The names of the supplied source files, copy books, and macros, and the libraries in which they can be found, are listed in Table 26.

Table 26. Supplied source files, copy books, and macros

Name	Type	Description	Library
DFHZNEP0	Program	Default node error program (assembler language)	CICSTS32.CICS.SDFHSAMP
DFHZNEPX	Source	Default NEP (embedded by DFHZNEP0 via COPY statement)	CICSTS32.CICS.SDFHSAMP
DFHSNEP	Macro	Sample NEP program generator (assembler language)	CICSTS32.CICS.SDFHMAC
DFHZNEPI	Macro	NEP interface generator (for multiple NEPs)	CICSTS32.CICS.SDFHMAC
DFHNEPCA	Macro	Assembler-language communication area	CICSTS32.CICS.SDFHMAC
DFHNEPCA	Copy book	C-language communication area	CICSTS32.CICS.SDFHC370

If you code in assembler language, you can use the sample NEP as a framework on which to construct your own node error program.

## Restrictions on the use of EXEC CICS commands

There are certain restrictions on the commands that a NEP can issue. **The use of any commands which require a principal facility causes unpredictable results, and should be avoided.** In particular, you should not use commands which invoke the following functions:

- Terminal control. For example, issuing EXEC CICS DELAY may cause the CSNE task to suspend and never resume, which can cause shutdown of the region to hang. (“CEMT-type” commands, such as EXEC CICS INQUIRE TERMINAL, are permissible)
- BMS (except routing)
- ISC communication (including function shipping). This includes START requests for remote transactions. Such requests are not recommended because CSNE (Node Abnormal Condition task) might become suspended while doing an ALLOCATE to the remote system.

If you need to start a remote transaction, start a local transaction which starts a remote one in turn.

- Updates to recoverable resources. If the resources are locked by another task, the CSNE unit of work could be suspended or shunted.

You should also note that you cannot use the NEP to suppress DFHZNAC messages.

## Entry and addressability

On entry, your NEP should issue the commands:

```
EXEC CICS ADDRESS COMMAREA
EXEC CICS ADDRESS EIB
```

These commands provide addressability to the communication area passed by DFHZNAC, and to the EXEC interface block, respectively.

If you write your node error program in assembler language, you generate the communication area DSECT by coding:

```
DFHNEPCA TYPE=DSECT
```

If you write your program in C, you include the communication area definitions by coding:

```
#include <dfhnepca>
```

## Coding for the 3270 'unavailable printer' condition

The 'unavailable printer' condition arises when a print request is made using the 3270 print request facility, and there are no printers on the control unit, or when the printers are in one of the following conditions:

- Out of service
- Not in TRANSCEIVE or RECEIVE status for automatic transaction initiation
- With a task currently attached
- Busy on a previous operation
- Requiring intervention.

The procedure is applicable to 3270 logical units or to the 3270 compatibility mode logical unit when using the PRINTER and ALTPRINTER operands of the CEDA DEFINE TERMINAL command.

The terminal control program recognizes this condition, and issues a READ BUFFER request to collect the data into a terminal I/O area. The TIOA is of the same format as it is when an application program has issued a terminal control read buffer request.

The terminal control program VTAM section (DFHZCP) then queues the TCTTE to the node abnormal condition program with error code X'42' (TCZCUNPRT). The node abnormal condition program (DFHZNAC) writes to the CSNE transient data queue:

- DFHZC2497 UNAVAILABLE PRINTER (device types 3270P and LUTYPE3)
- DFHZC3493 INVALID DEVICE TYPE FOR A PRINT REQUEST (all other printer device types).



Before linking to the node error program, DFHZNAC inserts the primary and secondary printer netnames and terminal IDs into the communication area, indicating also whether either printer is eligible for a print request. DFHZNAC links to the node error program with no default actions set.

On return from the node error program, DFHZNAC checks the additional system parameter TWAUPRRRC in the communication area (see Figure 31 on page 489) and, based on its contents, performs one of the following actions:

- If your NEP sets TWAUPRRRC to X'FF' (-1), DFHZNAC assumes that the node error program has disposed of the data to be printed and therefore takes no further action.
- If your NEP sets TWAUPRRRC to zero, DFHZNAC assumes that no printer is available and takes no further action.
- If your NEP sets TWAUPRRRC to neither zero nor -1, DFHZNAC assumes that one of either field TWAPNETN or field TWAPNTID is set. (If both are set, TWAPNTID(termid) takes precedence.) An interval control PUT is performed to the provided terminal. The transaction to be initiated is CSPP (print program), and the time interval is zero.
  - If an error occurs on the interval control PUT, DFHZNAC writes the 'DFHZC2496 IC FAILURE' message to the destination CSNE. DFHZNAC then links to the node error program again with the TWAUPRRRC field set to -2. This is done to give the node error program a last chance to dispose of the data. On the second return from the node error program to DFHZNAC, the latter reexamines TWAUPRRRC. If TWAUPRRRC is -1, then the node error program has disposed of the data.
  - If no error occurs on the interval control PUT, DFHZNAC checks for the following printer conditions:
    - 'Out of service'
    - 'Intervention required'
    - Any condition other than RECEIVE or TRANSCEIVE status.If one of these conditions is true, DFHZNAC issues the 'DFH2495 PRINTER OUTSERV/IR/INELIGIBLE-REQ QUEUED' message to the destination CSNE.

Finally, DFHZNAC terminates any print requests on the originating terminal and performs normal action flag processing on that terminal.

## Coding for session failures

Following some categories of error associated with logical unit or path failures, the session between CICS and the logical unit may be lost. The default action taken by DFHZNAC may be to put the TCTTE out of service.

A method of automatically reacquiring the session is for your node error program to alter the default DFHZNAC actions and to keep the TCTTE in service. Your node error program can then issue an EXEC CICS START TERMID(name) command against that TCTTE for a transaction written in a similar manner to the CICS "good morning" signon message (CSGM). When the transaction is initiated using automatic transaction initiation (ATI), CICS tries to reacquire the session. If the session fails again, DFHZNAC is reinvoked and the process is repeated.

The time specified on the EXEC CICS START command is determined by installation-dependent expected-mean-time-to values.

If used in this way, the initiated transaction can write an appropriate signon message when the session has been acquired. Note, however, that if LOGONMSG=YES is specified on the CEDA DEFINE TYPETERM command, the CICS “good morning” message is also initiated when the session is opened. Refer to “Restrictions on the use of EXEC CICS commands” on page 505.

## Coding for specific VTAM sense codes

Figure 35 shows how your NEP error processors could test for the presence of specific VTAM sense codes.

```

TEST1  EQU      *
        CLC     TWASENSR(2),SNS1          SENSE CODE EQUAL TO NNNN
        BNE     TEST2                    NO, THEN NEXT TEST
        NI      TWAOPT1,TWAOAF           PRINT ACTION MESSAGES ONLY
        OI      TWAOPT2,TWAOAS+TWAOAR+TWAOT ABANDON SEND,RECEIVE AND TASK
        NI      TWAOPT2,255-TWAOASM      SET SIMLOGON OFF
        OI      TWAOPT3,TWAOINT         SET INTLOG NOW ALLOWED
        NI      TWAOPT3,255-TWAOININT    OR RESET NOINTLOG
        B       END
        .
        .
        .
SNS1    DC      X'NNNN'
```

Figure 35. Sample code, showing how your node error program could test for specific VTAM sense codes

## Writing multiple NEPs

You can write several node error programs, as described in “Multiple NEPs” on page 485. When an error occurs, the node abnormal condition program passes control to an interface module, DFHZNEPI, which determines the transaction class and passes control to the appropriate node error program.

If only one node error program is used, the interface module (DFHZNEPI) is not required. If the node error program is named DFHZNEP, the node abnormal condition program branches directly to that. If more than one node error program is used, the interface module (DFHZNEPI) is required. In this case, the node error programs must be given names other than DFHZNEP. There must be an installed program definition for every node error program generated.

## DFHZNEPI macros

The following macros are required to generate the node error program interface module (DFHZNEPI):

- DFHZNEPI TYPE=INITIAL to specify the name of the default transaction-class routine.
- DFHZNEPI TYPE=ENTRY to associate a transaction-class with a transaction-class error handling routine.
- DFHZNEPI TYPE=FINAL to end the DFHZNEPI entries.

The DFHZNEPI interface module must be generated when you require the node abnormal condition program to pass control to the appropriate user-written node error program for resolution of the error.

## DFHZNEPI TYPE=INITIAL—specifying the default routine

The DFHZNEPI TYPE=INITIAL macro specifies the name of the default transaction-class routine to be used for the DFHZNEPI module.

```
DFHZNEPI TYPE=INITIAL  
[,DEFAULT=name]
```

### DEFAULT=name

specifies the name of the default transaction-class routine to be used. A link is made to this default routine if you specify for the transaction (using the CEDA DEFINE PROFILE, CEDA DEFINE SESSIONS, or CEDA DEFINE TYPETERM command) a NEPCCLASS value of 0 (the default) or higher than 255, or if you do not specify a transaction-class routine using the DFHZNEPI TYPE=ENTRY macro for the class specified on the NEPCCLASS operand.

If either of the preceding conditions is true, but you do not code the DEFAULT operand, then no routine is invoked.

The DFHZNEPI TYPE=INITIAL macro must always be specified, and must be placed before any other forms of the DFHZNEPI macro. Only one TYPE=INITIAL macro can be specified.

## DFHZNEPI TYPE=ENTRY—specifying a transaction-class routine

You use the DFHZNEPI TYPE=ENTRY macro to associate a transaction class (NEPCCLASS) with a transaction-class error handling routine. The format of this macro is:

```
DFHZNEPI TYPE=ENTRY  
  ,NEPCLAS=integer  
  ,NEPNAME=name
```

### NEPCLAS=integer

specifies the transaction-class, and must be in the range 1 through 255. No value should be specified that has been specified in a previous DFHZNEPI TYPE=ENTRY instruction.

### NEPNAME=name

specifies a name for the transaction-class routine to be associated with the specified transaction-class. An error condition results if the name is specified either as DFHZNEP, or is longer than 8 characters.

**Note:** You can use the sample node error program (with a name other than DFHZNEP) as a transaction-class routine for the interface module, DFHZNEPI.

## DFHZNEPI TYPE=FINAL—terminating DFHZNEPI entries

```
DFHZNEPI TYPE=FINAL
```

### TYPE=FINAL

completes the definition of module DFHZNEPI and must be specified last. The assembly should be terminated by an END statement with no entry name specified, or by the statement: END DFHZNENA.

## Handling shutdown hung terminals in the node error program

Error Code: X'6F'  
Symbolic Name: TCZSDAS  
Message Number: DFHZC2351

For error code X'6F', DFHZNAC passes the setting of TCSACTN and the DFHZC2351 reason code to DFHZNEP, and DFHZNEP can modify the force-close action for the current terminal.

### How DFHZNAC passes the setting of TCSACTN to DFHZNEP

For error code X'6F', DFHZNAC passes the setting of the TCSACTN system initialization parameter to DFHZNEP by setting TWAOSCN. TWAOSCN off (B'0') indicates TCSACTN=NONE, and TWAOSCN on (B'1') indicates TCSACTN=UNBIND.

### How DFHZNAC passes the DFHZC2351 reason code to DFHZNEP

For error code X'6F', the DFHZC2351 reason code is passed to DFHZNEP in the NEP communications area (NEPCA) field TWATRSN. TWATRSN is a 1-byte code field. Note that, currently, TWATRSN overlays TWAREASN (also a 1-byte field). The codes, and their meaning, are:

01 Request in progress	06 Waiting for RTR
02 Task still active	07 BID in progress
03 Waiting for SHUTC	08 Other TC work pending
04 Waiting for BIS	99 (X'63') Undetermined
05 Waiting for UNBIND	

See Terminal Control message DFHZC2351 for further details.

### How DFHZNEP can modify the force-close action for the current terminal

For error code X'6F', DFHZNEP can modify the force-close action, for the current terminal, by setting TWAOSCN. If DFHZNEP sets TWAOSCN off (B'0'), DFHZNAC will not attempt to force-close the terminal (TCSACTN=NONE), however, if DFHZNEP sets TWAOSCN on (B'1'), DFHZNAC will attempt to force-close the terminal (TCSACTN=UNBIND). Internally, DFHZNAC achieves this by converting the TWAOSCN normal close to a TWAOCN forced close. DFHZNEP cannot modify either of the system initialization parameters TCSWAIT or TCSACTN.

---

## Using the node error program with XRF or persistent sessions

This section contains guidance information about the NEP in an XRF or persistent sessions environment for CICS Transaction Server for z/OS, Version 3 Release 2.

### The node error program in an XRF environment

The CICS extended recovery facility (XRF) is described in the *CICS/ESA 3.3 XRF Guide*. If you are using XRF, a VTAM failure in your active CICS system may cause a takeover by the alternate CICS system. Each terminal from the failing system that is switched to the alternate system is passed to DFHZNAC for “conversation-restart” processing. This is similar to “session opened” processing for a normal session start.

One of the steps in the conversation-restart process is to link to the node error program with error code X'3F'. If you want to be able to change any of the

system-wide recovery notification options (whether terminal users are notified of a recovery, the recovery message, or the recovery transaction) for some terminals, you should write your own error processor to handle code X'3F'. (For details of the recovery notification parameters passed to the NEP, see the listing of communication area fields in Figure 31 on page 489.)

## The node error program with persistent session support

Persistent session support is described in the *CICS Recovery and Restart Guide*.

One of the steps in the conversation-restart process is to link to the node error program with error code X'FD'. If you want to be able to change any of the system-wide recovery notification options (whether terminal users are notified of a recovery, the recovery message, or the recovery transaction) for some terminals, you should write your own error processor to handle code X'FD'.

When using persistent sessions, note the following:

- When a session has been recovered, it may be a good idea to run NEP processing equivalent to your normal “session started” (code X'48') processing, because code X'48' is not passed on session recovery when persistent sessions are used.
- In certain situations where sessions have persisted over a failure but have been unbound on restart (for example, a COLD start occurs after a CICS failure), the NEP is not driven. (In systems without persistent sessions support, the NEP is always driven with code X'49', “session terminated”, when a VTAM session terminates.) Conditions leading to the issuing of the following messages do not drive the NEP. The messages appear on the system console:

```
DFHZC0120      DFHZC0124
DFHZC0121      DFHZC0129
DFHZC0122      DFHZC0130
DFHZC0123
```

Conditions leading to the issuing of messages DFHZC0125 and DFHZC0131 drive the NEP with codes X'FB' and X'FC' respectively. It is recommended that you run NEP processing equivalent to your normal “session terminated” NEP processing for these conditions.

- If zero is specified on the AIRDELAY system initialization parameter, autoinstalled terminals are not recovered after a restart. Similarly, if the delay period specified on AIRDELAY expires before an autoinstalled terminal is used after a restart, the terminal definition is deleted. In these circumstances, any expected NEP processing as a result of CLSDSTP=NOTIFY being coded does not take place.

## Changing the recovery notification

The method of recovery notification for a terminal is defined using the RECOVNOTIFY option of the TYPETERM definition, which is described in the *CICS Resource Definition Guide*. This is the most efficient way to specify the recovery notification method for the whole network, because CICS initiates the notification procedure during the early stages of takeover.

You can use the node error program to change the recovery notification method for some of the switched terminals. For example, you may want most terminals of a particular type to receive the recovery message at takeover, but the rest to get no notification that service has been restored. To achieve this, you could code RECOVNOTIFY(MESSAGE) in the TYPETERM definition, and then use the node error program to change the recovery notification to NONE for the relatively few terminals that are not to be notified.

## Changing the recovery message

If you define a terminal with RECOVNOTIFY(MESSAGE) in its TYPETERM definition, a recovery message is sent to the terminal after takeover. By default, for an XRF takeover, this is the following CICS-supplied message in BMS map DFHXRC1 of map set DFHXMSG:

```
CICS/ESA has recovered after a system failure.  
Execute recovery procedures.
```

For a persistent sessions recovery, BMS map DFHXRC3 is used; this map prefixes the above message with CICS/ESA message number DFHZC0199. You can specify your own map set in the node error program if you want to change the recovery message for some of the switched terminals. This could be useful, for example, if signon security is in force and you want to tell terminal users to sign on again. The map set that you specify must have an installed program definition. If you choose to change the recovery message for all terminals, it would be more efficient to replace the CICS-supplied map with your own.

## Changing the recovery transaction

The recovery transaction, to be started at a terminal after takeover, is specified using the RMTRAN system initialization parameter. This is the most efficient way of specifying a recovery transaction for the network. You can specify a different transaction for some of the switched terminals by overwriting field TWAXTRAN in the communication area. The transaction that you specify must have an installed transaction definition, and the terminal must be defined with the option ATI(YES).

If the transaction specified in TWAXTRAN does not exist, CICS tries to start the CSGM transaction. If this also fails, CICS terminates the session.

---

## Using the node error program with VTAM generic resources

The EXEC CICS ISSUE PASS command can be used (either from an application program, or by means of CECI) to disconnect a terminal from CICS, and transfer it to the VTAM application specified on the LUNAME option. For example, to transfer a terminal from this CICS to another terminal-owning region, you could issue the command:

```
CECI ISSUE PASS LUNAME(applid)
```

where applid is the APPLID of the TOR to which the terminal is to be transferred.

If your TORs are members of a VTAM generic resource group, you can transfer a terminal to any member of the group by specifying LUNAME as the generic resource name. For example:

```
CECI ISSUE PASS LUNAME(grname)
```

where grname is the generic resource name. VTAM chooses the most suitable group member to which to transfer the terminal. (If you need to transfer a terminal to a specific TOR within the CICS generic resource group, you must specify LUNAME as the member name—that is, the CICS APPLID, as in the first example.)

Note that, if the system that issues an ISSUE PASS LUNAME(grname) command is the *only* CICS currently registered under the generic resource name (for example,

the others have all been shut down), the ISSUE PASS command does **not** fail with an INVREQ. Instead, the terminal is logged off and message DFHZC3490 is written to the CSNE log.

You may want to code your node error program to deal with the situation when message DFHZC3490 (DFHZNAC error code X'C3') is issued.





---

## Chapter 10. Writing a program to control autoinstall of terminals

### Considerations common to all user-replaceable programs

Note that the comments contained in Chapter 5, “General notes about user-replaceable programs,” on page 435 apply to this chapter.

This chapter describes how to write a program to control the automatic installation of locally-attached VTAM terminals (including APPC single-session devices). For information about controlling the automatic installation of local APPC connections that are initiated by BIND requests, see Chapter 12, “Writing a program to control autoinstall of APPC connections,” on page 543. For information about controlling the installation of shipped terminals and connections, see Chapter 14, “Writing a program to control autoinstall of shipped terminals,” on page 559. For information about controlling the installation of virtual terminals used by the CICS Client products and the 3270 bridge, see Chapter 15, “Writing a program to control autoinstall of virtual terminals,” on page 567.

The chapter is divided into the following sections:

1. “Autoinstalling terminals—preliminary considerations.”
2. “The autoinstall control program at INSTALL” on page 517. This contains:
  - “The communication area at INSTALL for terminals” on page 518
  - “How CICS builds the list of autoinstall models” on page 519
  - “Returning information to CICS” on page 520
  - “CICS action on return from the control program” on page 523.
3. “The autoinstall control program at DELETE” on page 525.
4. “Naming, testing, and debugging your autoinstall control program” on page 526.
5. “The sample autoinstall control programs for terminals” on page 527.

---

### Autoinstalling terminals—preliminary considerations

You use the `DEFINE TERMINAL(..)` and `DEFINE TYPETERM(..)` commands to define VTAM devices to CICS. These commands define the resource definitions in the CICS system definition file (CSD). Your definitions can specify that they can be used as models for autoinstall purposes. Defining and installing model resource definitions for terminal control enables CICS to create required entries in the terminal control table (TCT) automatically, whenever unknown devices request connection to CICS. A particular advantage of automatic installation (autoinstall) is that the resource occupies storage in the TCT only while it is connected to CICS and for a specified delay period after last use.

You use the autoinstall control program to select some of the data needed to automatically install your terminals—notably the CICS terminal name and the model name to be used in each instance. You can use the CICS-supplied autoinstall program, or extend it to suit your own purposes.

For an overview of autoinstall, see the *CICS Resource Definition Guide*. You should also read the sections in the same manual that describe the CEDA commands that create the environment in which your control program can work.

If you choose automatic installation for some or all of your terminals, you must:

- Create some model TERMINAL definitions.
- Define the terminals to VTAM, so that their definitions in VTAM match the model TERMINAL definitions in CICS.
- If you are using model terminal support (MTS), define the MTS tables to VTAM.
- Use the default autoinstall control program for terminals (DFHZATDX), or write your own program, using the source-code of the default program and the customization examples in this information as a basis. You can write an entirely new program if the default program does not meet your needs, but you are recommended to try a default-based program first. You can write your program in any of the languages supported by CICS—the source of the default program is provided in assembler language, COBOL, PL/I, and C. You can rename your user-written program.

**Note:**

1. You should compile your autoinstall control program (or the supplied DFHZCTDX) using a Language Environment - enabled compiler, and you must run the program with Language Environment enabled.
2. You can have only one active autoinstall control program to handle both terminals and APPC connections. You specify the name of the active program on the AIEXIT system initialization parameter. The DFHZATDY program described in Chapter 12, “Writing a program to control autoinstall of APPC connections,” on page 543 provides the same function for terminal autoinstall as DFHZATDX, but in addition provides function to autoinstall APPC connections initiated by BIND requests. Both DFHZATDX and DFHZATDY provide function to install shipped terminals and connections. So, for example, if you want to autoinstall APPC connections as well as VTAM terminals, you should use a customized version of DFHZATDY, rather than DFHZATDX.

## Coding entries in the VTAM LOGON mode table

CICS uses the logmode data in the VTAM LOGON mode table when processing an autoinstall request. Autoinstall functions properly only if the logmode entries that you define to VTAM have matches among the model TERMINAL definitions that you specify to CICS.

The tables in Appendix A, “Coding entries in the VTAM LOGON mode table,” on page 833 show, for a variety of possible terminal devices, what you must have coded on the VTAM MODEENT macros that define, in your logmode table, the terminals that you want to install automatically. Between them, the tables show the values that must be specified for each of the operands of the MODEENT macro.

Some of the examples in the appendix correspond exactly to entries in the IBM-supplied logon mode table called ISTINCLM. Where this is so, the table gives the name of the entry in ISTINCLM.

## Using model terminal support (MTS)

CICS Transaction Server for z/OS supports the model terminal support (MTS) function of VTAM 3.3 and above.

Using MTS, you can define the model name, the printer (PRINTER), and the alternate printer (ALTPRINTER) for each terminal in a VTAM table. This information is sent by VTAM in an extended CINIT RU. CICS captures it as part of autoinstall processing at logon, and uses it to create a TCTTE for the terminal.

## Coding entries for MTS

You need to define model names (MDLTAB, MDLENT, and MDLPLU macros) and printer and associated printer names (ASLTAB, ASLENT, and ASLPLU macros) to VTAM.

## The autoinstall control program for terminals

In addition to managing your resource definition, your autoinstall control program can perform any other processes that you want at this time. Its access to the command-level interface is that of a normal, nonterminal user task. Some possible uses are listed “The sample autoinstall control programs for terminals” on page 527.

The control program is invoked when:

1. An autoinstall INSTALL request is being processed
2. An autoinstall DELETE request has just been completed
3. An autoinstall request has previously been accepted by the user program, but the subsequent INSTALL process has failed.

On each invocation of the autoinstall control program, a parameter list is passed (using a communication area), describing the function being performed (INSTALL or DELETE), and providing data relevant to the particular event. (In case 3 above, the control program is invoked as if for DELETE).

The INSTALL and DELETE events are now described in detail.

---

## The autoinstall control program at INSTALL

If autoinstall is operative, the autoinstall control program is invoked at INSTALL for:

- Local VTAM terminals
- MVS consoles
- Local APPC single-session connections initiated by a CINIT
- Local APPC parallel-session connections initiated by a BIND
- Local APPC single-session connections initiated by a BIND
- Client virtual terminals
- Shipped terminals and connections.

On each invocation, CICS passes a parameter list to the control program by means of a communication area addressed by DFHEICAP. The parameter list passed at INSTALL of MVS consoles is described in “The autoinstall control program at INSTALL” on page 536. The parameter list passed at INSTALL of local APPC connections initiated by BIND requests is described in “The communication area at INSTALL for APPC connections” on page 545. The parameter list passed at INSTALL of shipped terminals and connections is described in “The communications area at INSTALL for shipped terminals” on page 562. The parameter list passed at INSTALL of client virtual terminals is described in “The communications area at INSTALL for Client virtual terminals” on page 571. The parameter list passed at INSTALL of MVS consoles is described in Chapter 11, “Writing a program to control autoinstall of consoles,” on page 535. This section describes only INSTALL of local terminals (including APPC single-session connections initiated by a CINIT).

The control program is invoked at INSTALL for terminals when both:

- A VTAM logon request has been received from a resource eligible for automatic installation whose NETNAME is not in the TCT.

- Autoinstall processing has been completed to a point where information (a terminal identifier and autoinstall model name) from the control program is required to proceed.

## The communication area at INSTALL for terminals

The layout of the communication area is shown in Figure 36.

Fullword 1	Standard Header	
Byte 1	Function Code	(X'F0' for INSTALL)
Bytes 2 - 3	Component Code	Always 'ZC'
Byte 4	Reserved	Always X'00'
Fullword 2	Pointer to NETNAME_FIELD	
Fullword 3	Pointer to MODELNAME_LIST	
Fullword 4	Pointer to SELECTED_PARMS	
Fullword 5	Pointer to CINIT_RU	

Figure 36. Autoinstall control program's communication area at INSTALL

The parameter list contains the following information:

1. Standard Header. Byte 1 indicates the request type (this is hexadecimal character X'F0' for INSTALL).
2. Pointer to a 2-byte length field, followed by the NETNAME of the resource requesting LOGON.
3. Pointer to an array of names of eligible autoinstall models. The array is preceded by a 2-byte field describing the number of 8-byte name elements in the array. If there are no elements in the array, the number field is set to zero.
4. Pointer to the area of storage that you use to return information to CICS, and where the MTS information from the VTAM CINIT is stored.
5. Pointer to VTAM LOGON data (the CINIT request unit). The data is preceded by a 2-byte length field, indicating the length of the CINIT request unit, and includes the 3-character NS header. The format of the CINIT request unit is described in the *SNA Network Product Formats* manual.

CICS passes a list of eligible autoinstall models in the area addressed by fullword 3 of the parameter list.

If the model name is not supplied by MTS, the control program must select a model from this list that is suitable for the device logging on, and move the model name to the first 8 bytes of the area addressed by fullword 4 of the parameter list.

For example, if a 3270 printer attempts to autoinstall, the subset of matching models includes all the types in VTAM category 2 that you have defined as models. This subset could include any of the following:

- DEVICE(3270) TERMMODEL(2)
- DEVICE(3270) TERMMODEL(1)
- DEVICE(3270P) TERMMODEL(2)
- DEVICE(3270P) TERMMODEL(1)
- DEVICE(3275) TERMMODEL(2)
- DEVICE(3275) TERMMODEL(1).

The control program selects one model from this list, and CICS uses this model to build the TCTTE for the device. The default autoinstall control program, DFHZATDX, always selects the first model name in the list.

If you are not using MTS but need a printer ID or NETNAME (or an alternative printer ID or NETNAME) associated with this terminal, then your control program can supply this in the area addressed by fullword 4.

If you are using MTS, CICS passes the control program the printer and alternative printer NETNAMEs specified on the VTAM ASLTAB macro.

Before returning to CICS, the control program must supply a CICS terminal name for the device logging on, and must set the return code field to X'00' if the autoinstall request is to be allowed.

Figure 37 shows all of these fields in their required order.

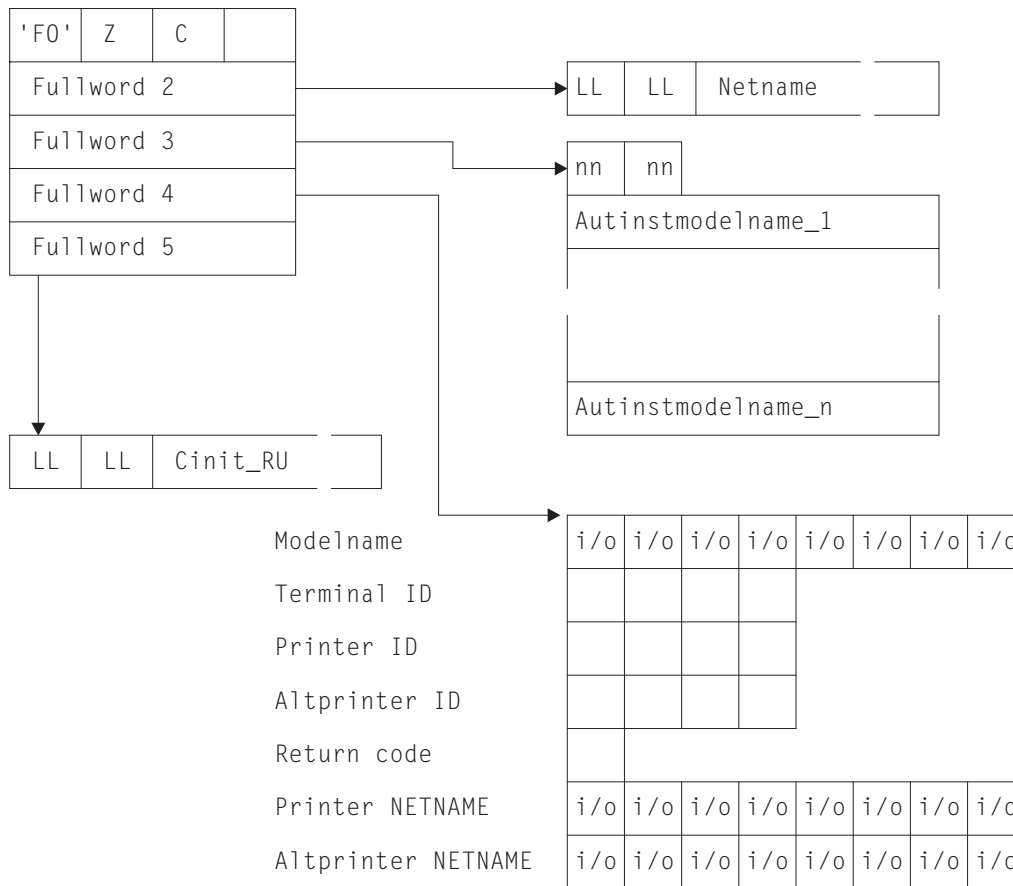

Note: i/o designates an input/output field. The other fields in SELECTED\_PARMS are output only. Input may be supplied by MTS from the MTS CINIT.

Figure 37. Autoinstall control program's parameter list at INSTALL

## How CICS builds the list of autoinstall models

If CICS finds an MTS model name (and the model is defined to CICS and is compatible with the VTAM information describing the resource), CICS puts the

model name into the model name list (Autinstmodelname\_1), and also into the model name field (Modelname) in the selection list addressed by fullword 4 of the parameter list.

If CICS is unable to find an MTS model name in the MTS Control Vector, or the named model does not exist or is invalid, it builds the list of autoinstall models by selecting from the complete list of terminal models those models that are compatible with the VTAM information describing the resource. The complete list of autoinstall models available to CICS at any time comprises all the definitions with AUTINSTMODEL(YES) and AUTINSTMODEL(ONLY) that have been installed, both by the GRPLIST at a CICS initial or cold start, and by INSTALL GROUP commands issued by CEDA. The *CICS Resource Definition Guide* describes the definition of models.

Table 49 on page 834 gives you the information to work out which model types could be included in the subset of models passed to the autoinstall control program when a particular terminal attempts to install. The subset is determined by the VTAM characteristics of the device attempting to log on. The number in the right-hand column of the figure indicates the selection of the subset from the full list. When a terminal with a given combination of DEVICE, SESSIONTYPE, and TERMMODEL values attempts to logon, the subset of matching models passed to the control program includes all the models with DEVICE, SESSIONTYPE, and TERMMODEL values that have a corresponding VTAM category number in the right-hand column of the table.

If CICS finds no model that exactly matches the BIND, and if the return code in the area addressed by fullword 4 of the parameter list is nonzero, then CICS issues error message 'DFHZC6987'. This message contains a "best failure" model name, which is provided for diagnostic purposes only. It is described in detail in "CICS action on return from the control program" on page 523, and in *CICS Messages and Codes*.

## Returning information to CICS

At the INSTALL event, the autoinstall control program is responsible for allowing or denying the connection of a new terminal resource to the CICS system. This decision can be based on a number of installation-dependent factors, such as security, or the total number of connected terminals. CICS takes no part in any such checking. You decide whether any such checking takes place, and how it is done.

If the INSTALL request is to proceed, the control program **must** do the following:

- Return an autoinstall model name in the first 8 bytes of the area addressed by fullword 4 of the parameter list, unless this has already been set by MTS support. If the control program returns a model name not in the subset passed to it by CICS, CICS cannot guarantee what will happen when further processing takes place. It is the user's responsibility to determine the effect of associating any particular logon request with a particular model name, because no interface is provided to the in-storage "model" objects.
- Supply a CICS terminal name (TERMID) in the next four bytes of the return area. DFHZATDX takes the last four nonblank characters of the NETNAME (addressed by fullword 2 of the parameter list) as the terminal name, so you must code your own autoinstall program if this does not match your installation's naming conventions. See "Setting the TERMINAL name" on page 522 for information on this.

Note that when processing an AUTOINSTALL request for an LU6.2 single session terminal the four byte terminal identifier returned by the user program is

used to name a CONNECTION. It should therefore conform to the naming standards for a CONNECTION (rather than a TERMINAL) as defined in CONNECTION definition attributes, in the *CICS Resource Definition Guide*. The user program could identify an LU6.2 AUTOINSTALL request in one of the following ways:

- Use a MODEL naming convention and examine the model name pointed to by fullword 3.
- Test bytes 14 and 15 of the CINIT BIND which is pointed to by fullword 5 for X'0602' (LU6.2).
- Set the return code to X'00'.

On entry to the autoinstall control program, the return code always has a nonzero value. If you do not change this, the autoinstall request is rejected.

If you are not using MTS, your control program can also supply or change any of the optional values, such as PRINTER and ALTPRINTER IDs or NETNAMEs, before returning to CICS. If you need information about the formats and acceptable character ranges for any of the return values, refer to the *CICS Resource Definition Guide*.

If you are using MTS, then VTAM supplies the PRINTER and ALTPRINTER NETNAMEs, if specified.

The printers need not be installed at this stage; however, they must be installed before you use Print Key support. PRINTER and ALTPRINTER IDs override PRINTER and ALTPRINTER NETNAMEs.

Note that TERMID, PRINTER, and ALTPRINTER are the only attributes of the TERMINAL definition that can be set by the autoinstall control program; all other attributes must come from one of these sources:

- The VTAM LOGMODE entry (MODEENT)
- The autoinstall model TERMINAL definition
- The TYPETERM definition that it refers to
- The QUERY function
- Model names from VTAM MDLTAB MDLENT and printers' NETNAMEs from VTAM ASLTAB ASLENT (if you are using MTS).

**Note:**

1. The QUERY function overrides any extended attributes specified in the TYPETERM definition.
2. You cannot override information in the LOGMODE entry, with the model TERMINAL and TYPETERM; they must match.

If your control program decides to reject the INSTALL request, it should return to CICS with a nonzero value in the return code.

Having completed processing, the control program must return to CICS by issuing an EXEC CICS RETURN command.

### Selecting the autoinstall model

If you are using model terminal support to supply the model name (and the named model exists and is valid), CICS passes the model name to your autoinstall control program—you do not need to make any further selection.

As a general rule, all the models in the list passed to your program match the VTAM data for the terminal. That is, a viable TCT entry usually results from the use of any of the models. (The exception to this rule involves the VTAM RUSIZE; if this value is incompatible, CICS issues an error message.) The default autoinstall control program merely picks the first model in the list. However, this model may not provide the attributes required in all cases. For instance, you do not want a 3270 display device definition for a 3270 printer. Your control program must be able to select the model that provides the characteristics you require for this terminal—for example, security characteristics.

To save on storage, you should try to minimize the number of different models available to the control program, and the number of different TYPETERM definitions referenced by those models. If you are migrating your definitions from DFHTCT macros, look carefully at them and eliminate those that are unnecessarily different from others. Use the QUERY function for all devices that can support it. For bisynchronous devices, which do not support QUERY, one approach is to make the definition as straightforward as possible, with no special features.

If you need special models for special cases, you can use a simple mapping of, for example, NETNAME (generic or specific) to AUTINSTNAME. Your control program could go through a table of special case NETNAMEs, choosing the specified model for each. The default model would be used for any terminal not in the table. (Note that the list of models presented to the control program is in alphabetical order with one exception which is described in the notes to Table 50 on page 836.)

### **Setting the TERMINAL name**

The TERMINAL name must be unique, and one through four characters long. For a list of the acceptable characters, see the *CICS Resource Definition Guide*. The TERMINAL name is the identifier CICS uses for the terminal. The NETNAME is the identifier VTAM uses for the terminal.

You may have transactions that depend on the terminals from which they are initiated, or to which they will be attached, having particular TERMINAL names. Some transactions are restricted to particular terminals and others behave in different ways, depending on the terminal. In some cases, the transaction may gather statistics about terminal use, using the TERMINAL name as a reference. The TERMINAL name may have meaning to those managing, using, or maintaining the network: it may, for instance, denote geographical location or departmental function.

The NETNAME is really more suitable for these purposes than the TERMINAL name, because it is eight characters in length. If you can use the NETNAME, the TERMINAL name can be randomly assigned by the autoinstall control program, and it does not matter if a terminal has a different TERMINAL name every time the user logs on. The control program is required, in this case, only to make the TERMINAL name unique within the system in which the terminal is to be autoinstalled. If the control program attempts to install a TCT entry for a TERMINAL name that already has a TCT entry, the installation is rejected, despite the fact that the terminal is eligible and a suitable model has been found. (By contrast, if the NETNAME already has a TCT entry, the terminal uses it and autoinstall can never be invoked.)

The default autoinstall control program creates the TERMINAL name from the last four nonblank characters of the NETNAME. This may not satisfy the requirement for uniqueness. One way of overcoming this problem is to use the EXEC CICS INQUIRE command from the control program, to determine whether the TERMINAL name is already in use. If it is, modify the last character and check again.



However, you may be in a situation where you must continue to use unique and predictable TERMINAL names for your terminals. Your control program must be able to assign the right TERMINAL name to each terminal, every time the user logs on. Two possible approaches to this problem are:

- Devise another algorithm to generate predictable TERMINAL names from NETNAMEs
- Use a table or file to map TERMINAL names to NETNAMEs.

Devising an algorithm avoids the disadvantages of using a table or a file, but it might be difficult to ensure both uniqueness and predictability. If some of the information in the NETNAME is not needed by CICS, it can be omitted from the TERMINAL name. An algorithm is probably most appropriate in this situation.

Using a table has two disadvantages, each of which loses you some of the benefits of autoinstall: it takes up storage and it must be maintained. You could create a table in main temporary storage, so that it is placed in extended storage, above 16MB. You could use a VSAM file rather than a table, to avoid the storage problem. However, this might be slower, because of the I/O associated with a file. The table or file can contain information such as PRINTER and ALTPRINTER, and you can add information such as AUTINSTNAME for devices that need particular autoinstall models. (See “Selecting the autoinstall model” on page 521.)

**Considerations for VTAM dynamic alias names:** If a CICS region is using dynamic LU aliases (that is, LUAPFX=xx is specified on the VTAM APPL definition), selecting a unique TERMINAL name may be more complicated than otherwise. The following factors should be considered:

- The default programs use the last 4 characters of the NETNAME, which does not produce a repeatable TERMID for an LU that is assigned a dynamic LU alias. Consider using the network qualified name in the CINIT or BIND if it is important that the termid is repeatable for each logon.
- If you use the last 4 characters of the NETNAME, a dynamic LU alias produces a terminal id of 0001, 0002, and so on. Check that your RDO-defined terminals do not have such names, and if necessary change your autoinstall control program's logic. For example, you could use the last character of the NETID concatenated with the last 3 from the real network name.
- There is some new sample code in DFHZATDX and DFHZATDY that extracts the network qualified name, referenced as NQNAME, from the CINIT or BIND and uses the last character of the NETID and the last 3 characters of the real network name to provide an alternative TERMID.

If this logic fails to create a termid for any reason it drops through to create the terminal id from the network name as usual. Note this code is enclosed within comments and is supplied only to illustrate how to extract the required information from the CINIT and BIND '0E' control vectors

- The sample code is also added in the form of comments to the C, COBOL, and PL/I versions of DFHZATDX. If you use these, note that:
  - The PL/I sample, DFHZPTDX, must be compiled with the PL/I compiler option LANGLVL(SPROG).
  - The COBOL sample, DFHZCTDX, must be compiled with compiler option TRUNC(OPT).

## CICS action on return from the control program

When CICS receives control back from the autoinstall control program, it examines the return code field. If this is zero, and if the other required information supplied is

satisfactory, CICS schedules the new resource for OPNDST in order to complete the logon request. If the installation process fails, then the control program is driven again, as though a DELETE had occurred. (See the section “The autoinstall control program at DELETE” on page 525 for details.) This is necessary to allow the program to free any allocations (for example, terminal identifiers) made on the assumption that this INSTALL request would succeed.

If the return code is not zero, then CICS rejects the connection request in the same way as it rejects an attempt by an unknown terminal to log on to CICS when autoinstall is not enabled.

For all autoinstall activity, messages are written to the transient data destination CADL. If an INSTALL fails, a message is sent to CADL, with a reason code. You can therefore check the output from CADL to find out why an autoinstall request failed.

If an autoinstall attempt fails for lack of an exact match, then details of the “best failure” match between a model and the BIND image are written to the CADL transient data destination.

The message takes the following form:

```
DFHZC6987 BEST FAILURE FOR NETNAME: nnnnnnnn,  
        WAS MODEL_NAME: mmmmmmmm,  
        CINIT BIND: cccccccc...,  
        MODEL BIND: bbbbbbbb...,  
        MISMATCH BITS: xxxxxxxx...
```

where

- ‘nnnnnnnn’ is the netname of the LU which failed to log on.
- ‘mmmmmmm’ is the name of model that gave the best failure. (That is, the one that had the fewest bits different from the BIND image supplied by VTAM.)
- ‘ccccccc...’ is the CINIT BIND image.
- ‘bbbbbbb...’ is the model BIND image.
- ‘xxxxxxx...’ is a string of hexadecimal digits, where ‘xx’ represents one byte, and each byte position represents the corresponding byte position in the BIND image. A bit set to ‘1’ indicates a mismatch in that position between the BIND image from VTAM and the BIND image associated with the model.

A suggested course of action is as follows:

1. Determine whether a model such as ‘mmmmmmm’ is suitable. If there are several models that have identical BIND images, differing only in end-user options, then only the first such model is named in the above message. It will be up to your control program to make the choice, when the logmode table entry is corrected.
2. Identify the VTAM logmode table entry that is being used.
3. Check that this logmode table entry is not successfully in use with other applications, so that to change it might cause this other use of it to fail.
4. Amend the logmode table entry by switching the bits corresponding to 1-bits in the mismatch string. That is, if the bit in the VTAM BIND image corresponding to the bit position set to ‘1’ in ‘xxxxxxx...’ above is ‘1’, set it to ‘0’; if it is ‘0’, set it to ‘1’.

More information about the meaning of the bits in a BIND image, and some more references, may be found in *ACF/VTAM Version 3 Programming*.

## The autoinstall control program at DELETE

To provide symmetry of control over the autoinstall process, the autoinstall control program is also invoked when:

- A session with a previously automatically-installed resource has been ended
- An autoinstall request was accepted by the user program, but the subsequent INSTALL process failed for some reason.

To make it easier for you to write your control program, these two events can be considered to be identical. (There is no difference in the environment that exists, or in the actions that might need to be performed.)

Invoking the control program at DELETE enables you to reverse the processes carried out at the INSTALL event. For example, if the control program at INSTALL incremented a count of the total number of automatically installed resources, then the control program at DELETE would decrement that count.

## The communication area at DELETE for terminals

Input to the program is via a communication area, addressed by DFHEICAP. The layout of the communication area is shown in Figure 38.

Fullword 1	Standard Header
Byte 1	Function Code (X'F1')
Bytes 2 - 3	Component Code Always 'ZC'
Byte 4	Reserved Always X'00'
Fullword 2	Terminal ID of terminal to be deleted
Fullword 3	NETNAME of terminal to be deleted
Bytes 1-2	Delete netname length
Bytes 3-4	Start of Delete netname ID
Next 15 bytes	Remainder of Delete netname ID

Figure 38. Autoinstall control program's communication area at DELETE. For terminals (including APPC single-session devices).

The parameter list contains the following information:

1. Standard Header. Byte 1 indicates the request type. For deletion of local terminals (including APPC single-session devices installed via CINIT requests) the value is X'F1'.

**Note:** A value of X'F5' or X'F6' represents the deletion of a local APPC connection that was installed by a BIND request—see page “The autoinstall control program at DELETE” on page 549. A value of X'FA' or X'FB' represents the deletion of a shipped terminal or connection—see page “The autoinstall control program at DELETE” on page 564. A value of X'FC' represents the deletion of a client virtual terminal—see page “The autoinstall control program at DELETE” on page 575.

2. The terminal identifier of the deleted resource, as shown in Table 27.

Table 27. Autoinstall control program's parameter list at DELETE

	1st byte	2nd byte	3rd byte	4th byte
First fullword	"F1"	"Z"	"C"	Reserved
Second fullword	ID of terminal to be deleted			

Table 27. Autoinstall control program's parameter list at DELETE (continued)

	1st byte	2nd byte	3rd byte	4th byte
<b>Third fullword</b>	Length of netname to be deleted		First two bytes of netname	
<b>Next 15 bytes</b>	Remainder of netname			

Note that the named resource has been deleted by the time the control program is invoked, and is not therefore found by any TC LOCATE type functions.

---

## Naming, testing, and debugging your autoinstall control program

### Finding the name of an autoinstall control program

The supplied, user-replaceable autoinstall control program for terminals and APPC single-session connections initiated by CINIT is named DFHZATDX. If you write your own version, you can name it differently.

After the system has been loaded, to find the name of the autoinstall control program currently identified to CICS, use either the EXEC CICS INQUIRE AUTOINSTALL command or the CEMT INQUIRE AUTOINSTALL command.

The default is DFHZATDX.

To change the current program:

- Use the AEXIT system initialization parameter. For guidance information about how to do this, refer to the *CICS System Definition Guide*.
- Make the change online using either the EXEC CICS SET AUTOINSTALL command or the CEMT SET AUTOINSTALL command. For further information about these commands, refer to the *CICS System Programming Reference* and *CICS Supplied Transactions*, respectively.

### Testing and debugging

To help you test the operation of your autoinstall control program, you can run the program as a normal terminal-related application. Define your program and initiate it from a terminal. The parameter list passed to the program is described in “The autoinstall control program at INSTALL” on page 517. You can construct a dummy parameter list in your test program, upon which operations can be performed. Running your program on a terminal before you use it properly means that you can use the EDF transaction to help debug your program. You can also make the program interactive, sending and receiving data from the terminal.

If you find that CICS does not offer any autoinstall models to your program, you can create a test autoinstall program that forces the model name (AUTINSTNAME) you want. With a VTAM buffer trace running, try to log the device on to CICS. If CICS does not attempt to send a BIND, check the following:

- Does the model TERMINAL refer to the correct TYPETERM? (Or alternatively, is the TYPETERM in question referred to by the correct TERMINAL definition?)
- Is the TERMINAL definition AUTINSTMODEL(YES or ONLY)?
- Have you installed the group containing the autoinstall models (TERMINAL and TYPETERM definitions)?

If CICS attempts to BIND, compare the device's CINIT RU to the CICS BIND, and make corrections accordingly.

It is very important that you ensure that the VTAM LOGMODE table entries for your terminals are correct, rather than defining new autoinstall models to fit incorrectly coded entries. Bear in mind, while you are testing, that CICS autoinstall does not work if a LOGMODE entry is incorrectly coded.

Note that you cannot **force** device attributes by specifying them in the TYPETERM definition. For autoinstall, the attributes defined in the LOGMODE entry must **match** those defined in the model; otherwise the model will not be selected. You cannot define a terminal in one way to VTAM and in another way to CICS.

If your control program abends, CICS does not, by default, cause a transaction dump to be written. To cause a dump to be taken after an abend, your program must issue an EXEC CICS HANDLE ABEND command.

---

## The sample autoinstall control programs for terminals

The CICS-supplied default autoinstall program is an assembler-language command-level program, named DFHZATDX. The source of the default program is provided in COBOL, PL/I, and C, as well as in assembler language. The names of the supplied programs and their associated copy books, and the CICSTS32.CICS libraries in which they can be found, are summarized in Table 28. Note that the COBOL, PL/I, and C copy books each have an alias of DFHTCUDS.

Table 28. Autoinstall programs and copy books

Language	Member name	Alias	Library
Programs:			
Assembler	DFHZATDX	None	SDFHSAMP
COBOL	DFHZCTDX	None	SDFHSAMP
PL/I	DFHZPTDX	None	SDFHSAMP
C	DFHZDTEX	None	SDFHSAMP
Copy books:			
Assembler	DFHTCUDS	None	SDFHMAC
COBOL	DFHTCUD	DFHTCUDS	SDFHCOB
PL/I	DFHTCUDP	DFHTCUDS	SDFHPL1
C	DFHTCUD	DFHTCUDS	SDFHC370

The module generated from the assembler-language source program is part of the pregenerated library shipped in CICSTS32.CICS.SDFHLOAD. You can use it without modification, or you can customize it according to your own requirements. If you choose to alter the code in the sample program, take a copy of the sample and modify it. After modification, use the DFHEITAL procedure to translate, assemble, and link-edit your module. Then put the load module into a user library that is concatenated before CICSTS32.CICS.SDFHLOAD in the DFHRPL statement. (This method applies to completely new modules as well as modified sample modules.) For more guidance information about this procedure, refer to Using the CICS-supplied procedures to install application programs, in the *CICS Application Programming Guide*. Do not overwrite the sample with your customized module, because subsequent service may overwrite your module. You must install a new resource definition for a customized user program.

The default action of the sample program, on INSTALL, is to select the first model in the list, and derive the terminal identifier from the last four nonblank characters of the NETNAME, set the status byte, and return to CICS. If there are no models in the list, it returns with no action.

The default action, on DELETE, is to address the passed parameter list, and return to CICS with no action.

You can customize the sample program to carry out any processing that suits your installation. Examples of customization are given in “Customizing the sample program.” Generally, your user program could:

- Count and limit the total number of logged-on terminals.
- Count and limit the number of automatically installed terminals.
- Keep utilization information about specific terminals.
- Map TERMINAL name and NETNAME.
- Map TNADDR (TCP/IP client address, IP port and, optionally, host name) of automatically installed terminals.
- Do general logging.
- Handle special cases (for example, always allow specific terminals or users to log on).
- Send messages to the operator.
- Exercise network-wide control over autoinstall. A network-wide, global autoinstall control program can reside on one CICS system. When an autoinstall request is received by a control program on a remote CICS system, this global control program can be invoked and data transferred from one control program to another.

## Customizing the sample program

Here are three pieces of code that customize the sample program.

Before using any of the sample programs in a production environment, you would need to customize it to suit your installation.

### Assembler language

Figure 39 on page 529, in assembler language, limits logon to netnames L77A and L77B. The model names utilized are known in advance. A logon request from any other terminal, or a request for a model which cannot be found, is rejected.

```

* REGISTER CONVENTIONS =
* R0 used by DFHEICAL expansion
* R1 -----"-----"-----"-----
* R2 Base for Input parameters
* R3 Base for code addressability
* R4 Base for model name list
* R5 Base for output parameter list
* R6 Work register
* R7 -----"-----
* R8 -----"-----
* R9 free
* R10 Internal subroutine linkage return
* R11 Base for EIB
* R12 free
* R13 Base for dynamic storage
* R14 used by DFHEICAL expansion
* R15 -----"-----"-----"-----
*
* SELECT MODEL
*
*      LH R6, TABLEN      Number of valid netnames
*      LA R7, TABLE      Address the table
*
* LOOP1 CLC NETNAME(4), 0(R7)  Is this netname in table?
*      BE VALIDT
*
*      LA R7, 16(R7)      Next table entry
*      BCT R6, LOOP1
*
*      Now we know its not a valid netname
*      simply return and the logon is rejected
*
*      B RETURN
*

```

Figure 39. Example of how to customize the DFHZATDX sample program (part 1)

```

*
VALIDT  CLI  SELECTED_MODELNAME,C' '      R7 now points to model name
        BNE  VALIDM1                      MTS model name supplied?
        LH   R6,MODELNAME_COUNT          Yes
        LTR  R6,R6                        Count of models
        BZ   RETURN                       Were any presented?
        LA   R8,MODELNAME                 No
        LA   R8,MODELNAME                 First model name
*
LOOP2   CLC  8(8,R7),0(R8)                Is this model name here?
        BE   VALIDM
*
        LA   R8,L'MODELNAME(R8)          Next model name
        BCT  R6,LOOP2
*
*
*      Now we know the required model name was not presented
*      to this exit by CICS, a return rejects the logon
*
        B    RETURN
*
*      At this point the model name was found in those presented
*      It is given to CICS and the new termid is
*      the netname
*
VALIDM  MVC  SELECTED_MODELNAME,0(R8)     R8 was left pointing at
*                                             model name
VALIDM1 DS   0H
        MVC  SELECTED_TERM_ID,NETNAME     Use netname for termid
*                                             (4 chars)
*
*
* SELECTIONS COMPLETE, RETURN
*
        MVI  SELECTED_RETURN_CODE,X'00'   Indicate all OK
        B    RETURN                       Exit program
*
*      Table of netnames allowed to log on and the model name
*      necessary for the logon to be successful
*
*      Format of table :
*      Bytes 1 to 8   Netname allowed to log on
*      Bytes 9 to 16  Model required for netname
*
        DS   0D
TABLE   DC   CL8'L77A',CL8'3270064'
        DC   CL8'L77B',CL8'3270065'
TABLEN DC   Y((*-TABLE)/16)
*

```

Figure 40. Example of how to customize the DFHZATDX sample program (part 2)

## COBOL

Figure 41 on page 531, in COBOL, redefines the NETNAME, so that the last four characters are used to select a more suitable model than that selected in the sample control program.



```

*
* Redefine the netname so that the last 4 characters (of 7)
* can be used to select the autoinstall model to be used.
*
* The netnames to be supplied are known to be of the form:
*
*     HVMXNNN
*
* HVM is the prefix
* X  is the system name
* NNN is the address of the terminal
*
01 NETNAME-BITS.
02 FIRST-CHRS PIC X(3).
02 NEXT-CHRS.
03 NODE-LETTER PIC X(1).
03 NODE-ADDRESS PIC X(3).
02 LAST-CHR PIC X(1).
.
.
PROCEDURE DIVISION.
.
.
*
* Select the autoinstall model to be used according to the
* node letter (see above). The models to be used are user
* defined.
*
* (It is assumed that the netname supplied in the commarea by CICS
* has been moved to NETNAME-BITS).
*
* If the node letter is C then use model AUT02
* If the terminal netname is HVMC289 (a special case) then use
* model AUT01.
* Otherwise (node letters A,B,D...) use model AUT03.
*
IF NODE-LETTER = 'C' THEN MOVE 'AUT02' TO SELECTED-MODELNAME.
IF NEXT-CHRS = 'C289' THEN MOVE 'AUT01' TO SELECTED-MODELNAME.
IF NODE-LETTER = 'A' THEN MOVE 'AUT03' TO SELECTED-MODELNAME.
IF NODE-LETTER = 'B' THEN MOVE 'AUT03' TO SELECTED-MODELNAME.
IF NODE-LETTER = 'D' THEN MOVE 'AUT03' TO SELECTED-MODELNAME.
.
.

```

Figure 41. Example of how to customize the DFHZCTDX sample program

## PL/I

Figure 42 on page 532, in PL/I, extracts information from the VTAM CINIT RU, which carries the BIND image. Part of this information is the screen presentation services information, such as the default screen size and alternate screen size. The alternate screen size is used to determine the model of terminal that is requesting logon. The presented models are searched for a match, and if there is no match, the first model from those presented is used.

```

DCL 1 CINIT          BASED(INSTALL_CINIT_PTR),
  2 CINIT_LENG      FIXED BIN(15),
  2 CINIT_RU        CHAR(256);
DCL  SAVE_CINIT     CHAR(256);
/* Temp save area for CINIT RU */
DCL 1 SCRNSZ        BASED(ADDR(SAVE_CINIT)),
  2 SPARE           CHAR(31),
/* Bypass first part of CINIT and reach */
/* into BIND image carried in CINIT */
  2 DHGT            BIT(8),
/* Screen default height in BIND PS area */
  2 DWID            BIT(8),
/* Screen default width in BIND PS area */
  2 AHGT            BIT(8),
/* Screen alternate height in BIND PS area */
  2 AWID            BIT(8);
/* Screen alternate width in BIND PS area */
DCL  NAME           CHAR(2);
/* Used to work up a screen model type */
DCL  TERMID         PIC'9999' INIT(1) STATIC;
/* Used to work up a unique termid */
DCL  ENQ            CHAR(8) INIT('AUTOPRG');
/* Used to prevent multiple access to termid */
/* If model name supplied by MTS, bypass model name selection */
IF SELECTED_MODELNAME ^= '
  THEN GO TO MODEL_EXIT;
/* Clear the CINIT save area and move in the VTAM CINIT RU.*/
/* This is useful if you fail to recognize the model */
/* of terminal; provide a dump and analyze this data */
SAVE_CINIT = LOW(256);
SUBSTR(SAVE_CINIT,1,CINIT_LEN) = SUBSTR(CINIT_RU,1,CINIT_LEN);

```

Figure 42. Example of how to customize the DFHZPTDX sample program (part 1)

```

/* Now access the screen PS area in the portion of the BIND
   image presented in the CINIT RU */
/* using the screen alternate height as a guide to the model
   of terminal attempting logon. If this cannot be determined
   then default to the first model in the table */
SELECT (AHGT);          /* NOW GET SCRN ALTERNATE HEIGHT */
WHEN (12) NAME = 'M1';   /* MODEL 1 */
WHEN (32) NAME = 'M3';   /*      3 */
WHEN (43) NAME = 'M4';   /*      4 */
WHEN (27) NAME = 'M5';   /*      5 */
OTHERWISE NAME = 'M2';   /*      2 */
END;
/* Search the model entries for a matching entry.      */
/* The criterion here is that a model definition should*/
/* contain the chars M2 for a model 2, and so on.      */
/* For example, L3270M2, L3270M5                       */
/*   TERMM2, TERMM5                                     */
IF MODELNAME_COUNT = 0
THEN GO TO EXIT;
DO I = 1 TO MODELNAME_COUNT;
  IF INDEX(MODELNAME(I),NAME)
  THEN GO TO FOUND_MODEL;
END;
NO_MODEL: /* Matching entry was not found, default to first model*/
SELECTED_MODELNAME = MODELNAME(1);
GO TO MODEL_EXIT;
FOUND_MODEL: /* Move the selected model name to the return area */
SELECTED_MODELNAME = MODELNAME(I);
MODEL_EXIT: /* ENQ to stop multiple updates of counter.      */
/* A simple counter is used to generate unique              */
/* terminal identities, so concurrent access to              */
/* this counter is denied to ensure no two get              */
/* the same identifier or update the counter.                */

/* To use this method the program must be defined as resident.*/
EXEC CICS ENQ RESOURCE(ENQ);
SELECTED_TERMID = TERMID; /* Set SELECTED_TERMID to
                           count value */
TERMID = TERMID + 1; /* Increase the count value by 1 */
IF TERMID = 9999 THEN TERMID = 1; /* Reset if too large*/
EXEC CICS DEQ RESOURCE(ENQ);
NAME_EXIT:
INSTALL_RETURN_CODE = LOW(1);
/* Set stat field to X'00' to allow
   logon to be processed */

GO TO EXIT;
END INSTALL;

```

Figure 43. Example of how to customize the DFHZPTDX sample program (part 2)



---

## Chapter 11. Writing a program to control autoinstall of consoles

### Considerations common to all user-replaceable programs

Note that the comments contained in Chapter 5, “General notes about user-replaceable programs,” on page 435 apply to this chapter.

This chapter describes how to write a program to control the automatic installation of MVS console devices (including TSO consoles). For information about controlling the automatic installation of locally-attached VTAM terminals, see Chapter 10, “Writing a program to control autoinstall of terminals,” on page 515.

The chapter is divided into the following sections:

1. “Autoinstalling consoles—preliminary considerations”
2. “The autoinstall control program at INSTALL” on page 536
3. “The autoinstall control program at DELETE” on page 540
4. “The sample autoinstall control programs for consoles” on page 541.

---

### Autoinstalling consoles—preliminary considerations

The reasons for using autoinstall for MVS consoles are the same as those that apply to the autoinstall for VTAM devices: you don't have to define each device explicitly, and you save on storage (see “Autoinstalling terminals—preliminary considerations” on page 515).

### Leaving it all to CICS

For consoles, in addition to the normal autoinstall support, you can also choose to let CICS autoinstall consoles without calling the autoinstall program. In this case, CICS uses either:

- A model console definition with an AUTINSTNAME (model name) that matches the MVS console name, or
- The first suitable console model it finds in alphanumeric sequence

If the autoinstall control program is not called, CICS generates a 4-character termid starting with the  $\neg$  (logical not) symbol.

If you want CICS to install your consoles automatically:

- Specify AICONS=AUTO (or issue a CEMT (or EXEC CICS) SET AUTOINSTALL CONSOLES(FULLAUTO) command).
- Create at least one model TERMINAL definition that references a TYPETERM definition specifying DEVICE(CONSOLE). You can use the IBM-supplied definition in group DFHTERMC if it suits your needs.
- Install the model TERMINAL and TYPETERM definition.

### Using an autoinstall control program

If you choose to have your autoinstall control program invoked for consoles, follow these steps:

- Use the default autoinstall control program for terminals (DFHZATDX or DFHZATDY), or write your own program, using the source code of the default program and the customization examples in this chapter as a basis.

**Note:**

1. You can have only one active autoinstall control program to handle terminals, consoles, and APPC connections. You specify the name of the active program on the AIXIT system initialization parameter.
  2. Your autoinstall program must be able to recognise the console INSTALL and DELETE parameter lists and return a model name, termid and return code.
- Enable the CICS AUTOINSTALL function for consoles. You can do this either by specifying AICONS=YES as a system initialization parameter, or by issuing a SET AUTOINSTALL CONSOLES(PROGAUTO) command.
  - Specify the AIXIT system initialization parameter to define your autoinstall control program to CICS.

If AICONS=YES is specified, or a CEMT (or EXEC CICS) SET AUTOINSTALL CONSOLES(PROGAUTO) has been issued, CICS invokes your autoinstall control program when:

- An autoinstall INSTALL request is being processed.
- An autoinstall request has previously been accepted by the autoinstall control program, but the subsequent INSTALL process has failed.
- The delay period since the console was last used has elapsed.

---

## The autoinstall control program at INSTALL

If autoinstall is operative, you can specify that CICS is to invoke the autoinstall control program for MVS consoles, in addition to those devices listed on page “The autoinstall control program at INSTALL” on page 517. To enable CICS to invoke the autoinstall control program for consoles, specify AICONS=YES as a system initialization parameter, or issue a SET AUTOINSTALL CONSOLES(PROGAUTO) command.

On each invocation of the autoinstall control program, CICS passes a parameter list to the control program by means of a communication area addressed by DFHEICAP. This section describes only the install function of console definitions.

The control program is invoked at INSTALL for a console when:

- CICS has received a MODIFY command from an MVS console whose console name is not defined in the TCT.
- CICS has completed autoinstall processing to a point where it needs a terminal identifier and autoinstall model name, from the autoinstall control program, in order to process the CICS transaction passed on the MVS modify command.

## The communication area at INSTALL for consoles

The layout of the communication area is shown in Figure 44 on page 537.

Fullword 1	Standard Header	
Byte 1	Function Code	(X'FD' for INSTALL)
Bytes 2 - 3	Component Code	Always 'ZC'
Byte 4	Reserved	Always X'00'
Fullword 2	Pointer to CONSOLENAME_FIELD	
Fullword 3	Pointer to MODELNAME_LIST	
Fullword 4	Pointer to SELECTED_PARMS	
Fullword 5	Reserved	

Figure 44. Autoinstall control program's communication area at INSTALL for consoles

The parameter list contains the following information:

1. A standard header. Byte 1 indicates the request type (this is hexadecimal character X'FD' for INSTALL), and bytes 2 to 3 contain the component code, which is always ZC for consoles. (Byte 4 is reserved.)
2. A pointer to a 2-byte length field, followed by the console name of the console which sent the message.
3. A pointer to an array of names of eligible autoinstall models. The array is preceded by a 2-byte field containing the number of 8-byte name elements in the array. If there are no elements in the array, the number field is set to zero.
4. A pointer to the area of storage that you use to return information to CICS.

CICS passes a list of eligible autoinstall models in the area addressed by fullword 3 of the parameter list. From this list, the control program must select a model that is suitable for the console device, and move the model name to the first 8 bytes of the area addressed by fullword 4 of the parameter list. Before returning to CICS, the control program must supply a CICS 4-character terminal ID for the console being logged on, and set the return code field to X'00' if the autoinstall request is to be allowed. Your program can also set the delay period that is to follow the last use of a console before it is automatically deleted by CICS. On entry to your autoinstall control program, this value is set to a default value of 60 minutes. Override this by storing your own delay period, in minutes, as a fullword binary value. Setting this field to zero (0) means that CICS never deletes the console.

Figure 45 on page 538 shows all of these fields in their required order.





If you want an INSTALL request to proceed, perform these steps in your autoinstall control program:

- Return an autoinstall model name in the first 8 bytes of the area addressed by fullword 4 of the parameter list.
- Supply a CICS terminal name (TERMID) in the next four bytes of the return area. DFHZATDX and DFHZATDY take the last four non-blank characters of the console name (addressed by fullword 2 of the parameter list) as the terminal name. If this does not meet with your installation's naming conventions, code your own autoinstall program.
- Set the return code to X'00'. On entry to the autoinstall control program, the return code always has a nonzero value. If you do not change this, the autoinstall request is rejected.
- Set the delete delay period, or leave it set to the default value of 60 minutes.

Note that these are the only attributes of the TERMINAL definition that can be set by the autoinstall control program; all other attributes must come from one of the following sources:

- The MVS console interface block (CIB)
- The autoinstall model TERMINAL definition
- The TYPETERM definition to which it refers.

If your control program decides to reject the INSTALL request, it should return to CICS with a non-zero value in the return code. Having completed processing, the control program must return to CICS by issuing an EXEC CICS RETURN command.

### **Selecting the autoinstall model**

All the models in the list passed to your program are for consoles. That is to say, a viable TCT entry usually results from the use of any one of them. The default autoinstall control program simply picks the first model in the list. However, this model may not provide the attributes required in all cases. Your control program must be able to select the model that provides the characteristics you require for the console—for example, one that has the required security characteristics.

### **Setting the TERMINAL name**

The TERMINAL name must be unique, and be one- through four-characters long. The TERMINAL name is the identifier CICS uses for the console. The CONSNAME value is the identifier MVS uses for the console.

If the control program attempts to install a TCT entry for a TERMINAL name that already has a TCT entry, the installation is rejected, even if the terminal is eligible and a suitable model has been found. On the other hand, if a MODIFY command is received from an MVS console for which CICS already has an entry in the TCT with a matching CONSNAME, CICS uses that entry and does not invoke your autoinstall control program.

The default autoinstall control program creates the TERMINAL name from the last four non-blank characters of the CONSNAME. This may not satisfy the requirement for uniqueness. One way of overcoming this problem is to use the EXEC CICS INQUIRE command from the control program, to determine whether the TERMINAL name is already in use. If it is, modify the last character and check again.

## CICS action on return from the control program

When CICS receives control back from the autoinstall control program, it examines the return code field:

- If the return code is zero, and the other required information supplied is satisfactory, CICS schedules the transaction specified on the MODIFY command to complete the request. If the installation process fails, the autoinstall control program is driven again, as though a DELETE function is being processed.
- If the return code is not zero, CICS rejects the connection request in the same way that it rejects an attempt by an unknown console to send a modify request to CICS when autoinstall is not enabled.

For all autoinstall activity, messages are written to the transient data destination CADL. If an INSTALL fails, a message is sent to CADL, with a reason code. You can check the output from CADL to find out why an autoinstall request failed.

---

## The autoinstall control program at DELETE

To provide symmetry of control over the autoinstall process, the autoinstall control program is also invoked when:

- A console autoinstall request was accepted by the user program, but the INSTALL process failed.
- The delete delay period has passed since the console was last used and CICS is running with AICONS=YES in effect. You can query this status of autoinstall for consoles by issuing a CEMT INQUIRE AUTOINSTALL command. If AICONS=YES is specified, CEMT INQUIRE AUTOINSTALL displays CONSOLES(PROGAUTO).

Input to the program is through a communication area, addressed by DFHEICAP. The layout of the communication area is shown in Figure 46.

Fullword 1	Standard Header
Byte 1	Function Code (X'FE')
Bytes 2 - 3	Component Code Always 'ZC'
Byte 4	Reserved Always X'00'
Fullword 2	Terminal ID of console being deleted
Fullword 3	Consolename of console being deleted
Bytes 1-2	Deleted consolename length
Bytes 3-4	Start of deleted consolename ID
Next 6 bytes	Remainder of deleted consolename ID

Figure 46. Autoinstall control program's communication area at DELETE for consoles

The parameter list contains the following information:

1. A standard header, where byte 1 indicates the request type (this is hexadecimal character X'FE' for DELETE), and bytes 2 to 3 contain the component code, which is always ZC for consoles.
2. The second fullword contains the termid of the console that is being deleted.
3. The third fullword contains, in the first two bytes, the length of the deleted console name and, in the last two bytes, the first and second characters of the console name.
4. The last 6 bytes of the communications area contains the remainder of the console name (third to eighth characters).

---

## The sample autoinstall control programs for consoles

IBM supplies a default autoinstall control program, written in each of the supported programming languages, all of which contain the necessary support for handling consoles. For details of these, see “The sample autoinstall control programs for terminals” on page 527.



---

## Chapter 12. Writing a program to control autoinstall of APPC connections

### Considerations common to all user-replaceable programs

Note that the comments contained in Chapter 5, “General notes about user-replaceable programs,” on page 435 apply to this chapter.

This chapter describes how to write a program to control the automatic installation of local APPC connections. For information about controlling the automatic installation of local VTAM terminals, see Chapter 10, “Writing a program to control autoinstall of terminals,” on page 515. For information about controlling the installation of shipped terminals and connections, see Chapter 14, “Writing a program to control autoinstall of shipped terminals,” on page 559. For information about controlling the installation of virtual terminals used by the CICS Client products, see Chapter 15, “Writing a program to control autoinstall of virtual terminals,” on page 567.

The chapter is divided into the following sections:

1. “Autoinstalling APPC connections—preliminary considerations”
2. “The autoinstall control program at INSTALL” on page 545
3. “The autoinstall control program at DELETE” on page 549
4. “The sample autoinstall control program for APPC connections” on page 550.

**Note:** In this chapter, “connection” and “session” are used as general terms when explaining autoinstall. The names “CONNECTION” and “SESSIONS” are used to indicate the CICS resource types used to create the definitions.

---

### Autoinstalling APPC connections—preliminary considerations

In considering the autoinstall of local APPC connections, we need to distinguish between the following:

1. Local APPC single-session connections initiated by CINIT requests
2. Local APPC parallel- and single-session connections initiated by incoming bind requests. (By “incoming” we mean that the request is initiated by the partner system.)

#### Local APPC single-session connections initiated by CINIT

Autoinstall of local APPC single-session connections that are initiated by CINIT requests works in the same way as autoinstall for terminals. You must provide a TERMINAL—TYPETERM model pair, and a customized version of one of the supplied autoinstall control programs, DFHZATDX or DFHZATDY. See Chapter 10, “Writing a program to control autoinstall of terminals,” on page 515.

#### Local APPC parallel-session and single-session connections initiated by BIND

If autoinstall is enabled, and an incoming APPC BIND request is received for an APPC service manager (SNASVCMG) session (or for the only session of a single-session connection), and there is no matching CICS CONNECTION definition, a new connection is created and installed automatically.

Like autoinstall for other resources, autoinstall for APPC connections requires model definitions. However, unlike the model definitions used to autoinstall terminals, those used to autoinstall APPC links do not need to be defined explicitly as models. Instead, CICS can use any previously-installed connection definition as a “template” for a new definition. In order for autoinstall to work, you must have a template for each kind of connection you want to be autoinstalled.

## Autoinstall templates for APPC connections

The purpose of a template is to provide CICS with a definition that can be used for all connections with the same properties. You customize the supplied autoinstall control program, DFHZATDY, to select an appropriate template for each new connection, depending on the information it receives from VTAM.

A template consists of a CONNECTION definition and its associated SESSIONS definitions. You should have a definition installed for each different set of session properties you are going to need.

Any installed connection definition can be used as a template, but for performance reasons, your template should be an installed connection definition that you do not actually use. The definition is locked while CICS is copying it, and if you have a very large number of sessions autoinstalling, the delay may be noticeable.

## Benefits of autoinstall

Autoinstall support is likely to be beneficial if you have large numbers of APPC parallel session devices with identical characteristics. For example, if you had 1000 personal computers (PC)s, all with the same characteristics, you would set up one template to autoinstall all of them. If 500 of your PCs had one set of characteristics, and 500 had another set, you would set up two templates to autoinstall them.

Restart of any kind should be noticeably faster, especially when large numbers of terminals are involved.

Savings can also be made on systems management overheads, and on storage, as autoinstalled resources do not occupy space before they are used.

## Requirements for autoinstall

Autoinstall of APPC connections works with any supported release of ACF/VTAM.

You can have only one active autoinstall control program for terminals and connections. You must specify the name of the active program on the AIEXIT system initialization parameter. As well as providing function to autoinstall APPC connections initiated by BIND requests, the sample program, DFHZATDY, provides the same function for terminal autoinstall as the default control program, DFHZATDX, described in Chapter 10, “Writing a program to control autoinstall of terminals,” on page 515. Thus, you can use a customized version of DFHZATDY to autoinstall both terminals and APPC connections.

**Note:** Both DFHZATDX and DFHZATDY provide function to install shipped terminals and connections, and Client virtual terminals.

You may find the supplied version of DFHZATDY adequate for your purposes. If not, you can write a customized version of the supplied program, or create your own program to provide enhanced function.

## The autoinstall control program for APPC connections

The purpose of the autoinstall control program is to provide CICS with any extra information it needs to complete an autoinstall request. For APPC connections, the control program selects the template to be used, and provides a name for the new connection.

If autoinstall is enabled, when CICS receives an APPC BIND request for an SNASVCMG session (or for the only session of a single-session connection), if there is no matching CONNECTION definition, CICS passes the partner's VTAM NETNAME to the autoinstall control program. The control program uses information from the BIND, which is passed in the communications area, to select the most appropriate template on which to base a new connection.

The control program needs to know the NETNAME or SYSID of all the templates, in order to return the name of the most suitable one. If it attempts to use an unsuitable template, message DFHZC6922 is issued, explaining why the template is unusable.

If the template is usable, CICS makes a copy of the definitions within it and attempts to install the new CONNECTION definition. If the installation is not successful, message DFHZC6903 is issued.

## Recovery and restart

Autoinstalled connections are not cataloged by CICS, so they are not recovered at an emergency restart or a warm restart.

---

## The autoinstall control program at INSTALL

The autoinstall control program is invoked at INSTALL for:

- Local VTAM terminals
- MVS consoles
- Local APPC single-session connections initiated by a CINIT
- Local APPC parallel-session connections initiated by a BIND
- Local APPC single-session connections initiated by a BIND
- Shipped terminals and connections
- Client virtual terminals.

On each invocation, CICS passes a parameter list to the control program by means of a communication area addressed by DFHEICAP. The parameter list passed at INSTALL of local terminals and APPC single-session connections initiated by CINIT is described in “The communication area at INSTALL for terminals” on page 518. The parameter list passed at INSTALL of MVS consoles is described in “The autoinstall control program at INSTALL” on page 536. The parameter list passed at INSTALL of shipped terminals and connections is described in “The communications area at INSTALL for shipped terminals” on page 562. The parameter list passed at INSTALL of Client virtual terminals is described in “The communications area at INSTALL for Client virtual terminals” on page 571. This section describes only INSTALL of local APPC connections initiated by BIND requests.

## The communication area at INSTALL for APPC connections

The communications area is mapped by the DSECT for the assembler version of DFHZATDY, which is supplied in CICSTS32.CICS.SDFHMAC.

```

*-----*
* APPC Install parameter list - Functions 2, 3, and 4 *
*-----*
INSTALL_APPC_COMMAREA      DSECT      Install Parameter List
*
INSTALL_APPC_STANDARD      DS  F        Standard field
                           ORG INSTALL_APPC_STANDARD
INSTALL_APPC_EXIT_FUNCTION DS  XL1       Install request type
INSTALL_APPC_PS_CINIT      EQU X'F2'    Install PS via CINIT
INSTALL_APPC_PS_BIND       EQU X'F3'    Install PS via BIND
INSTALL_APPC_SS_BIND       EQU X'F4'    Install SS via BIND
INSTALL_APPC_EXIT_COMPONENT DS  CL2      Component ID 'ZC'
                           DS  XL1       Reserved
*
                           ORG ,
INSTALL_APPC_NETNAME_PTR   DS  A        -> NETNAME      Input
INSTALL_APPC_CINIT_PTR    DS  0A       -> CINIT_RU     Input
INSTALL_APPC_BIND_PTR     DS  A        -> BIND        Input
INSTALL_APPC_SELECTED_PTR DS  A        -> Return fields Output
INSTALL_APPC_SYNCLEVEL_PTR DS  A        -> Sync level   Input
*
INSTALL_APPC_TEMPLATE_NETNAME_PTR DS  A -> Template NETNAME I/O
INSTALL_APPC_TEMPLATE_SYSID_PTR DS  A -> Template SYSID  Output
INSTALL_APPC_SYSID_PTR    DS  A        -> New SYSID     Output
INSTALL_APPC_NETNAME2_PTR DS  A        -> Generic or    Input
                           member NETNAME
*
INSTALL_APPC_NETID_PTR    DS  A        -> Network ID of  Input
                           incoming bind
*
INSTALL_APPC_TYPE_PTR     DS  A        -> Generic      Input
                           resource type

*
TEMPLATE_NETNAME          DS  CL8      Put netname of template here
TEMPLATE_SYSID            DS  CL4      Put sysid of template here
SYSID                     DS  CL4      Put name of new connection here
SYNCLEVEL                 DS  XL2      Synclevel of new connection
APPC_NETID                DS  CL8      NETID of incoming bind
APPC_GR_TYPE              DS  CL1      G = NETNAME is generic resource name
                               M = NETNAME is member name
                               blank = This CICS is not a generic
                               resource or the partner is not a
                               generic resource.

APPC_NETNAME2_FIELD       DSECT
APPC_NETNAME2_LENGTH      DS  XL2      Length of NETNAME
APPC_NETNAME2             DS  0X      Generic or member NETNAME

```

Figure 47. Autoinstall control program's communications area at INSTALL. For APPC connections initiated by BIND requests.

#### INSTALL\_APPC\_STANDARD header

A fullword input field comprising the following information:

#### INSTALL\_APPC\_EXIT\_FUNCTION

A 1-byte field that defines the install request type. The equated values are:

#### INSTALL\_APPC\_PS\_CINIT

X'F2' represents an install request for an APPC parallel-session connection from a secondary node via a CINIT request.

**Note:** These requests cannot be received by CICS Transaction Server for z/OS, Version 3 Release 2.

#### INSTALL\_APPC\_PS\_BIND

X'F3' represents an install request for an APPC parallel-session connection via a BIND.



### **INSTALL\_APPC\_SS\_BIND**

X'F4' represents an install request for an APPC single-session connection via a BIND.

**Note:** The values X'F0' and X'F1' represent, respectively, install and delete requests for terminals (including APPC single-session devices). See Chapter 10, "Writing a program to control autoinstall of terminals," on page 515.

### **INSTALL\_APPC\_EXIT\_COMPONENT**

A 2-byte component code, which is set to 'ZC'.

### **INSTALL\_APPC\_NETNAME\_PTR**

A fullword pointer to a 2-byte length field, followed by the NETNAME to be installed (input field).

For connections to CICS TORs where the partner is a generic resource, NETNAME can be the partner's generic resource name, or its member name, depending on the setting of APPC\_GR\_TYPE. (For introductory information about generic resources, see Installation considerations for VTAM generic resources, in the *CICS Intercommunication Guide*.)

### **INSTALL\_APPC\_CINIT\_PTR**

A fullword pointer to an input field containing the incoming CINIT, if the incoming session is a secondary.

**Note:** Not applicable to CICS Transaction Server for z/OS, Version 3 Release 2.

### **INSTALL\_APPC\_BIND\_PTR**

A fullword pointer to a 2-byte length field, followed by an input field containing the incoming BIND.

### **INSTALL\_APPC\_SELECTED\_PTR**

A fullword pointer to the return fields. These are in the same format as those for autoinstall of terminals.

Note that for APPC autoinstall (functions X'F3' and X'F4') only the return code is used. You return other information for APPC in other fields defined in the communications area.

### **INSTALL\_APPC\_SYNCLEVEL\_PTR**

A fullword pointer to a 2-byte input field specifying the syncpoint level for the connection, which is extracted from the BIND. The possible values are:

**X'0000'**  
Synclevel 0

**X'0001'**  
Synclevel 1

**X'0002'**  
Synclevel 2.

### **INSTALL\_APPC\_TEMPLATE\_NETNAME\_PTR**

A fullword pointer to an 8-byte input/output area (TEMPLATE\_NETNAME). On invocation, TEMPLATE\_NETNAME normally contains blanks. However, if both the partner and the local CICS are registered as generic resources, it contains the NETNAME of the generic resource name connection, if one is present. (Generic resource name connections are described in Defining connections in a generic resource environment, in the *CICS Intercommunication Guide*.)

Your control program can use the `TEMPLATE_NETNAME` field to specify the `NETNAME` of the template. For connections between generic resources, your program can accept the suggested template passed by CICS, or specify a different one—either in this field or by overwriting the suggested template with blanks and putting a value in the `TEMPLATE_SYSID` field.

If the specified name is less than 8 bytes, it must be padded with trailing blanks. If, as an alternative to specifying the `NETNAME` of the template, your program specifies its `CONNECTION` name in `TEMPLATE_SYSID`, it should fill `TEMPLATE_NETNAME` with blanks.

#### **INSTALL\_APPC\_TEMPLATE\_SYSID\_PTR**

A fullword pointer to a 4-byte output area (`TEMPLATE_SYSID`) that your control program can use to specify the `SYSID` (connection name) of the template. If the name is less than 4 bytes, it must be padded with trailing blanks. If, as an alternative to specifying the `SYSID` of the template, your program specifies its `NETNAME` in `TEMPLATE_NETNAME`, it should fill `TEMPLATE_SYSID` with zeros.

#### **INSTALL\_APPC\_SYSID\_PTR**

A fullword pointer to a 4-byte output area in which your program must put the `SYSID` for the new autoinstalled connection. The name you supply must be unique. You can use the same or similar logic to create it that you use for creating a terminal ID. If the name is less than 4 bytes, it must be padded with trailing blanks.

If you are using recoverable resources, the `SYSID` chosen for a connection after a restart must be the same as that chosen in the previous CICS run.

#### **INSTALL\_APPC\_NETNAME2\_PTR**

A fullword pointer to a 2-byte length field, followed by an 8-byte input field (`APPC_NETNAME2`).

If both the partner and the local CICS are generic resources, `APPC_NETNAME2` is the partner's generic resource name or member name, depending on the setting of `APPC_GR_TYPE`.

If the partner is not a generic resource, `APPC_NETNAME2` contains the same value as `NETNAME`.

If the local CICS is not a generic resource, the value of `APPC_NETNAME2` is meaningless.

#### **INSTALL\_APPC\_NETID\_PTR**

A fullword pointer to an 8-byte input field containing the Network ID of the partner. This field is set whenever the local CICS is registered as a generic resource. At all other times it has a value of 0.

#### **INSTALL\_APPC\_GR\_TYPE\_PTR**

A fullword pointer to a 1-byte input field indicating whether this is a connection between generic resources and, if so, whether the `NETNAME` passed on the `BIND` is the partner's generic resource name or its member name. The equated values are:

**G** `NETNAME` is the partner's generic resource name and `APPC_NETNAME2` is its member name (applid).

**M** `NETNAME` is the partner's member name (applid) and `APPC_NETNAME2` is its generic resource name.

**Blank** This CICS is not registered as a generic resource or the partner is not registered.

---

## The autoinstall control program at DELETE

To provide symmetry of control over the autoinstall process, the autoinstall control program is also invoked when an autoinstalled APPC connection is deleted.

Invoking the control program at DELETE enables you to reverse the processes carried out at the INSTALL event. For example, if the control program at INSTALL incremented a count of the total number of automatically installed resources, then the control program at DELETE would decrement that count.

Input to the program is by a communication area, addressed by DFHEICAP. The layout of the communication area is shown in Figure 48.

Fullword 1	Standard Header	
Byte 1	Function Code	(X'F5' or X'F6')
Bytes 2 - 3	Component Code	Always "ZC"
Byte 4	Reserved	Always X'00'
Fullword 2	SYSID of deleted connection	
Fullword 3	NETNAME of deleted connection	
Bytes 1-2	NETNAME length	
Bytes 3-10	NETNAME	

Figure 48. Autoinstall control program's communication area at DELETE. For APPC connections initiated by BIND requests.

The Function Code byte (byte 1 of fullword 1) indicates why the user program has been invoked:

**X'F5'** After deletion of a parallel-session APPC connection that was initiated by a BIND.

**X'F6'** After deletion of a single-session APPC connection that was initiated by a BIND.

**Note:** The value X'F1' represents the deletion of a local terminal, or an APPC single-session device that was autoinstalled via a CINIT request—see page “The autoinstall control program at DELETE” on page 525. The value X'FA' or X'FB' represents the deletion of a shipped terminal or connection—see page “The autoinstall control program at DELETE” on page 564. The value X'FC' represents the deletion of a Client virtual terminal—see page “The autoinstall control program at DELETE” on page 575.

## When autoinstalled APPC connections are deleted

Any autoinstalled APPC connection entry is deleted if the connection is discarded (using the CEMT DISCARD command). In addition, connection entries can be deleted when the terminal or system logs off, or is disconnected from CICS. This kind of “implicit deletion” occurs for the following types of APPC autoinstalled connection:

### Single-session connections installed via a CINIT

These are deleted when the terminal user logs off, after the expiry of the AILDELAY system initialization value.

## Synclevel 1 connections installed via a BIND

Synclevel 1-only APPC connections autoinstalled via a BIND request (*except* for limited resource connections installed on a CICS generic resource member—see next section) are implicitly deleted at the following times:

- When the connection is released
- If VTAM abends
- When the VTAM ACB is closed by CICS
- After the expiry of the AIRDELAY interval following a warm or emergency start (if the value of the AIRDELAY system initialization parameter is greater than zero).

## Synclevel 2 connections installed via a BIND

Synclevel 2-capable APPC connections installed by a BIND request are implicitly deleted *only* if they are installed on a CICS generic resource member, and an affinity is ended. Otherwise, they are never implicitly deleted.

The same applies to synclevel 1-only, limited resource connections that are installed on a CICS generic resource member.

---

## The sample autoinstall control program for APPC connections

The sample control program for autoinstall of APPC connections is DFHZATDY. The source code, in assembler-language only, is in library CICSTS32.CICS.SDFHSAMP.

As well as providing function to autoinstall APPC connections initiated by BIND requests, DFHZATDY provides the same function for terminal autoinstall as the DFHZATDX program described in Chapter 10, “Writing a program to control autoinstall of terminals,” on page 515. Thus, you can use a customized version of DFHZATDY to autoinstall both terminals and APPC connections.

## Default actions of the sample program

The role of DFHZATDY in installing APPC connections is to choose the template to be used (by supplying its NETNAME or SYSID), and to supply the name (SYSID) of the new connection.

The actions taken by the supplied version of the program are to:

1. Examine the request type passed in the INSTALL\_APPC\_EXIT\_FUNCTION field:

**X'F0'** An incoming CINIT for a terminal or APPC single-session device. Proceed as for DFHZATDX. See Chapter 10, “Writing a program to control autoinstall of terminals,” on page 515.

**X'F1'** A delete request for a terminal or APPC single-session device. Proceed as for DFHZATDX. See Chapter 10, “Writing a program to control autoinstall of terminals,” on page 515.

**INSTALL\_APPC\_PS\_CINIT (X'F2')**

An incoming CINIT for an APPC parallel-session connection. Specify a template by setting the field pointed to by INSTALL\_APPC\_TEMPLATE\_SYSID to 'CCPS'.

**Note:** This type of request cannot be received by CICS Transaction Server for z/OS, Version 3 Release 2.

#### **INSTALL\_APPC\_PS\_BIND (X'F3')**

An incoming BIND for an APPC parallel-session connection. Specify a template. This is done in one of two ways:

- For connections between two generic resources, by accepting the suggested template (the generic resource name connection) whose NETNAME is passed in TEMPLATE\_NETNAME. If there is no generic resource name connection, set TEMPLATE\_SYSID to 'CBPS'.
- In all other cases, by setting TEMPLATE\_SYSID to 'CBPS'.

#### **INSTALL\_APPC\_SS\_BIND (X'F4')**

An incoming BIND for an APPC single-session connection. Specify a template by setting the field pointed to by INSTALL\_APPC\_TEMPLATE\_SYSID to 'CBSS'.

**X'F5'** A delete request for an APPC parallel-session connection installed by a BIND. Establish addressability to the COMMAREA and return.

**X'F6'** A delete request for an APPC single-session connection installed by a BIND. Establish addressability to the COMMAREA and return.

2. Specify a name for the new connection by copying the last 4 non-blank characters of the input NETNAME pointed to by INSTALL\_APPC\_NETNAME\_PTR to the field pointed to by INSTALL\_APPC\_SYSID\_PTR.
3. Indicate that a selection has been made by setting the return code to RETURN\_OK.

## **Resource definitions**

CICS supplies a resource definition group called DFHAI62, which defines DFHZATDY, and contains CONNECTION definitions for CCPS, CBPS, and CBSS. If you want to use the supplied version of DFHZATDY, you should append DFHAI62 to your CICS startup grouplist. However, if you customize DFHZATDY you will probably need to create your own definitions.

DFHZATDY is defined as follows in DFHAI62:

```
DEFINE PROGRAM(DFHZATDY)
DESCRIPTION(Assembler definition for sessions autoinstall control program)
GROUP(DFHAI62)
LANGUAGE(ASSEMBLER) RELOAD(NO) RESIDENT(NO)
USAGE(NORMAL) STATUS(ENABLED) CEDF(NO)
DATALOCATION(ANY) EXECKEY(CICS) EXECUTIONSET(FULLAPI)
```



---

## Chapter 13. Writing a program to control autoinstall of IPIC connections

### Considerations common to all user-replaceable programs

Note that the comments contained in Chapter 5, “General notes about user-replaceable programs,” on page 435 apply to this information.

This section describes how to write a program to control the automatic installation of IPIC connections. For information about controlling the automatic installation of ISC over SNA (or *APPC*) connections, see Chapter 12, “Writing a program to control autoinstall of APPC connections,” on page 543.

For introductory information about the different types of CICS intercommunication links, including IPIC (IPCONN) and ISC over SNA (APPC) connections, see the *CICS Intercommunication Guide*.

The chapter is divided into the following sections:

1. “Autoinstalling IPIC connections: preliminary considerations”
2. “The autoinstall user program at INSTALL” on page 555
3. “The autoinstall user program at DELETE” on page 556
4. “The sample autoinstall user program for IPIC connections (IPCONN)” on page 557.

---

### Autoinstalling IPIC connections: preliminary considerations

The IPCONN autoinstall user program is similar to the APPC autoinstall user program. Like the APPC autoinstall user program, the IPIC autoinstall user program can choose an installed connection to use as a template for the new connection. The main differences are that the template is an IPCONN rather than a CONNECTION definition and that the use of the template is optional.

If IPCONN autoinstall is active, CICS installs the new IPCONN resource using the following information:

- The information in the connect flow
- The IPCONN template, optionally selected by the IPCONN autoinstall user program
- Values returned by the user program in its communications area
- CICS-supplied values

### Autoinstall templates for IPCONNs

Unlike autoinstall for other resources, autoinstall for IPCONNs does not require model definitions, although they are recommended. However, unlike the model definitions used to autoinstall terminals, those used to autoinstall IPCONNs do not have to be defined explicitly as models. Instead, CICS can use any previously-installed IPCONN definition as a “template” for a new definition.

The purpose of a template is to provide CICS with a definition that can be used for all connections with the same properties. You customize the supplied autoinstall user program to select an appropriate template for each new connection, depending on the information it receives from CICS.

You can use any installed IPCONN definition as a template but, for performance reasons, your template must be an installed definition that is not in use. The definition is locked while CICS is copying it, and, if you have a large number of IPCONNs being autoinstalled at one time you might notice the delay.

## Requirements for autoinstall

To activate IPCONN autoinstall:

1. The receiving region must have installed at least one TCPIP SERVICE that specifies PROTOCOL(IPIC).
2. The name of the IPCONN autoinstall user program must be specified on the URM option of the installed TCPIP SERVICE definition. This requirement differs from the autoinstall of APPC connections, where the name of the autoinstall user program is specified on the AIXIT system initialization parameter. IPCONN autoinstall has no equivalent system initialization parameter. Instead, the name of the autoinstall user program is specified on the TCPIP SERVICE definition.

As with APPC, putting the template IPCONNs out-of-service disables the autoinstall function.

## When the user program is invoked

The user program is invoked when both the following conditions are met:

1. A TCPIP SERVICE that is defined with PROTOCOL(IPIC) receives either
  - A connect flow containing a NETWORKID and APPLID combination for which there is no installed IPCONN definitionor
  - A connect flow with a null APPLID.
2. The URM attribute of the receiving TCPIP SERVICE specifies the name of an autoinstall user program. If the URM attribute contains "NO", the autoinstall request is rejected.

## The autoinstall user program for IPCONNs

The autoinstall user program provides CICS with any extra information required to complete an autoinstall request. For IPIC connections, the user program provides a name for the new connection. Optionally, it can select an in-service IPCONN to use as a template, and modify the values of the APPLID, HOST, and PORT attributes of the new connection from those supplied on the connect flow.

RECEIVECOUNT on the autoinstalled IPCONN is set to the value requested on the connect flow from the client, or the minimum of this value and the RECEIVECOUNT from the template, if a template is specified. All other attributes of the new IPCONN are taken from the template, or from CICS-supplied values if no template is specified, and cannot be modified by the user program.

If the selected template is usable, CICS makes a copy of the definition in it and attempts to install the new IPCONN definition. If the installation is not successful, a message is issued.

The default autoinstall user program, DFHISAIP, is an assembler-language program. DFHISAIP is the default value of the URM option on a TCPIP SERVICE that specifies PROTOCOL(IPIC).



If the default user program is not adequate for your purposes, you can write a customized version of the default program or create your own program to provide enhanced function. CICS supplies the source code of the default program in several programming languages; see “The sample autoinstall user program for IPIC connections (IPCONN)” on page 557.

## Recovery and restart

Autoinstalled IPCONNnS are cataloged by CICS, for recovery at an emergency restart only. They are not recovered at a warm restart.

---

## The autoinstall user program at INSTALL

When the autoinstall user program is invoked for the installation of an IPCONN, CICS passes it a parameter list in a communication area addressed by DFHEICAP.

### The communication area at INSTALL for IPCONNnS

The communications area is mapped by the DSECT for the assembler version of DFHISAIP, which is supplied in CICSTS32.CICS.SDFHSAMP.

isaic_function	char(1)	Function code (X'F0' for Install)
isaic_response	char(1)	Response code
*	char(2)	Reserved
isaic_ipconn	char(8)	Name for the autoinstalled IPCONN
isaic_applid	char(8)	The applid of remote system
isaic_suggested_applid	char(8)	Suggested applid, if isaic_applid is blank
isaic_networkid	char(8)	Network ID of remote system
isaic_tcpipservice	char(8)	Name of the TCPIP SERVICE on which this connect flow arrived
isaic_template	char(8)	Name of the template IPCONN
isaic_host	char(116)	Host name of remote system
isaic_port	bin(4)	Call back port number of remote system
isaic_receivecount	bin(4)	Number of receive sessions wanted by remote system

Figure 49. Autoinstall user program's communications area at INSTALL. For IPCONNnS.

#### isaic\_applid (Input/Output)

An 8-character field containing the applid of the remote system trying to connect, as sent on the connect flow. The user program can change this value only if it is blank on input (which indicates that the connecting system is probably a Java client). If it is blank on output, CICS uses the “suggested applid” pointed to by the isaic\_suggested\_applid field.

#### isaic\_function (Input)

A 1-character code indicating the function for which the autoinstall user program has been invoked. Contains X'F0' for install.

#### isaic\_host (Input/Output)

A 116-character field containing the host name of the remote system, as passed in the connect flow. The autoinstall user program is allowed to modify this because it is possible that it has a better idea of what the connecting system is known as locally than does the system itself.

#### isaic\_ipconn (Output)

An 8-character field containing the name to be used for the autoinstalled IPCONN connection. The user program must supply the name.

**isaic\_networkid (Input)**

An 8-character field containing the network ID of the system trying to connect, as sent on the connect flow.

**isaic\_port (Input/Output)**

The call back port number for the client. -1 means that no call back is allowed. The autoinstall user program can modify this for the same reason that it can modify the host name, unless it is -1, in which case it cannot be changed. The autoinstall user program is also not allowed to change this value to -1.

**isaic\_receivecount (Input)**

A 4-byte binary field containing the number of receive sessions that the remote system wants to be supported by this IPCONN. (These are send sessions at the remote system end.)

**isaic\_response (Output)**

Response code: zero means OK.

**isaic\_suggested\_applid (Input)**

An 8-character field containing a remote system applid “suggested” by CICS. If the applid of the remote system pointed to by isaic\_applid is blank, CICS uses a counter to generate an 8-character decimal digit name in the form “00000027”.

**isaic\_tcpipservice (Input)**

An 8-character field containing the name of the TCPIP SERVICE on which this connect flow arrived.

**isaic\_template (Input/Output)**

An 8-character field containing the name of an installed IPCONN to be used as a template for the new IPCONN.

By default, this field is blank, and CICS supplies the information required to create the IPCONN.

The autoinstall user program can modify this field to name a template IPCONN. If the template IPCONN is out-of-service, the autoinstall request is rejected.

## The autoinstall user program at DELETE

To provide symmetry of control over the autoinstall process, the autoinstall user program is also invoked when an autoinstalled IPCONN is deleted.

Invoking the user program at DELETE enables you to reverse the processes carried out at the INSTALL event. For example, if the user program at INSTALL incremented a count of the total number of automatically installed resources, then the user program at DELETE would decrement that count.

Input to the program is by a communication area, addressed by DFHEICAP. The layout of the communication area is shown in Figure 50.

isaic_function	char(1)	Function code (X'F1' for Delete)
*	char(3)	Reserved
isaic_ipconn	char(8)	Name of the autoinstalled IPCONN
isaic_applid	char(8)	Applid of the autoinstalled IPCONN
isaic_networkid	char(8)	Network ID of the autoinstalled IPCONN
isaic_tcpipservice	char(8)	Name of the TCPIP SERVICE on which the connect flow arrived

Figure 50. Autoinstall user program's communication area at DELETE. For IPCONNs.

**isaic\_function (Input)**

The function for which the user program has been invoked:

**X'F1'** After deletion of an IPCONN.

**isaic\_ipconn (Input)**

The name of the autoinstalled IPCONN.

**isaic\_applid (Input)**

The applid (of the remote system) specified on the autoinstalled IPCONN.

**isaic\_networkid (Input)**

The network ID (of the remote system) specified on the autoinstalled IPCONN.

**isaic\_tcpipservice (Input)**

The name of the TCPIP SERVICE on which the connect flow arrived.

All fields in the DELETE communications area are input-only.

## When autoinstalled IPCONNs are deleted

An autoinstalled IPCONN is always deleted when they move to the RELEASED state. A RELEASED IPCONN continues to exist only when a CICS to CICS IPCONN is restored at emergency restart, when it waits for reacquire to allow recovery processing.

---

## The sample autoinstall user program for IPIC connections (IPCONN)

The default user program for autoinstall of IPCONNs is an assembler-language program called DFHISAIP. The corresponding copy book that defines its communications area is DFHISAIC. The source code of the default program, and the copy book of its communications area, are supplied in assembler-language, COBOL, PL/I, and C versions. The supplied programs and copy books, and the CICSTS32.CICS libraries in which they can be found, are summarized in Table 29.

*Table 29. IPCONN autoinstall user programs and copy books*

	Language	Member name	Library
Programs	Assembler	DFHISAIP	SDFHSAMP
	C	DFHISDIP	SDFHC370
	COBOL	DFHISCIP	SDFHCOB
	PL/I	DFHISPIP	SDFHPL1
Copy books	Assembler	DFHISAIC	SDFHSAMP
	C	DFHISAIC	SDFHC370
	COBOL	DFHISAIC	SDFHCOB
	PL/I	DFHISAIC	SDFHPL1

You can write your own IPCONN autoinstall user program in COBOL, PL/I, C, or assembler language.

## Default actions of the sample program

The role of the autoinstall user program in installing IPCONNs is to choose the IPCONN template to be used and to supply the name of the new connection. Optionally, the program can modify the values of the APPLID, HOST, and PORT attributes of the new connection from those supplied on the connect flow. All other attributes of the new IPCONN are taken from the template or the CICS-supplied default values and cannot be modified by the user program.

### At INSTALL

When invoked to install an IPCONN definition, the actions taken by the supplied version of the user program are to:

1. Specify a name for the new connection by setting the `isaic_ipconn` field equal to the last 4 non-blank characters of the connecting system's applid in the `isaic_applid` field.  
If the `isaic_applid` field is blank, set its value, and the connection name, to the "suggested\_applid" in the `isaic_suggested_applid` field.
2. Leave all other connection attributes to assume their default values, and return.

### At DELETE

When invoked to delete an IPCONN definition, the supplied version of the user program takes no action and returns immediately.

## Resource definitions

CICS supplies a resource definition group called DFHISCIP that defines the supplied, default, autoinstall program, DFHISAIP. This is included in the default CICS startup grouplist, DFHLIST. If you use a different CICS startup grouplist, ensure that you append the DFHISCIP group to it.

If you customize DFHISAIP, you may need to create your own resource definitions. When you do, ensure that you append your resource definition group to your CICS startup grouplist.

---

## Chapter 14. Writing a program to control autoinstall of shipped terminals

### Considerations common to all user-replaceable programs

Note that the comments contained in Chapter 5, “General notes about user-replaceable programs,” on page 435 apply to this chapter.

This chapter describes how to write a program to control the installation of shipped terminals and connections. Both the supplied autoinstall control programs, DFHZATDX and DFHZATDY, provide function to install shipped definitions of remote terminals and connections. You can therefore base your customized control program on either DFHZATDX or DFHZATDY.

Just as you can use an autoinstall user program in a terminal-owning region (TOR) to control the automatic installation of *local* terminals and connections, so you can use a similar program in an application-owning region (AOR) to control the installation of shipped terminals and connections. (Bear in mind when reading this chapter that it assumes that your user program is installed in an AOR—or in a combined AOR/TOR—rather than in a TOR.)

The chapter is divided into the following sections:

1. “Installing shipped terminals and connections”
2. “The autoinstall control program at INSTALL” on page 561
3. “The autoinstall control program at DELETE” on page 564
4. “Default actions of the sample programs” on page 565.

---

### Installing shipped terminals and connections

In releases of CICS before 4.1, the terminal identifiers (TERMIDs) of shippable terminals had to be unique in the transaction routing network. That is, you could not ship a terminal definition to an AOR on which a remote terminal of the same name was already installed. From CICS/ESA 4.1 onwards, this restriction does not apply. Because your autoinstall control program is invoked for shipped terminals and connections, you can use it to reset the TERMINAL (or CONNECTION) attribute of a shipped definition to an **alias**, thereby avoiding conflicts with names of remote terminals and connections already installed in the AOR. There is no need to reset the REMOTENAME attribute, which remains set to the name by which the terminal is known in the TOR; and autoinstall model names are not applicable to shipped definitions.

**Note:** If the name of a shipped definition clashes with the name of a *local* terminal or connection installed in the AOR, the install is rejected, and the autoinstall control program is not invoked.

For more information about using aliases on remote definitions, see Local and remote names for terminals, in the *CICS Intercommunication Guide*.

**Note:** The autoinstall control program is invoked for all shipped terminals and connections, including shipped definitions of the virtual terminals used by CICS Clients.

## CICS-generated aliases

The autoinstall control program is invoked once for each shipped terminal or connection definition to be installed.

If CICS detects that the name on a shipped definition clashes with the name of a remote terminal or connection already installed in the AOR, it generates an alias TERMID and passes it to the control program in field SELECTED\_SHIPPED\_TERMID of the communications area.

If CICS detects that there is no clash of names, it passes in SELECTED\_SHIPPED\_TERMID the name by which the terminal or connection is known in the TOR—that is, the value of the TERMINAL or CONNECTION attribute on the shipped definition.

Your control program can accept the passed TERMID, change it, or reject the installation of the shipped definition.

CICS-generated aliases consist of a 1-character prefix and a 3-character suffix. The prefix is always '{'. The suffix can have the values 'AAA' through '999'. That is, each character in the suffix can have the value 'A' through 'Z' or '0' through '9'. The first suffix generated by CICS has the value 'AAA'. This is followed by 'AAB', 'AAC', ... 'AAZ', 'AA0', 'AA1', and so on, up to '999'.

Each time that it needs to create an alias, CICS generates a 3-character suffix that it has not recorded as being in use. If your autoinstall control program overrides a CICS-generated TERMID, CICS does not record the suffix as being in use, and supplies the same suffix for the next alias.

## Resetting the terminal identifier

You need to think about the algorithm by which your control program allocates alias TERMIDs.

You must consider the consequences of a definition being deleted by the CICS timeout delete mechanism, and subsequently being re-shipped and re-installed. You must decide whether your autoinstall program should allocate the *same* TERMID as before (which implies a file mapping the name by which the terminal is known in the TOR to the alias allocated by the AOR), or whether allocation of a different TERMID is acceptable—in which case you could use the default aliases generated by CICS. This decision may depend on several factors. For example:

- How your application programs allocate temporary storage queue names. If they derive them from the TERMID (so as to associate the queue with a particular end-user), problems of data mismatch could occur if the queue is not emptied by transaction end (possibly due to a failure), and TERMIDs are not allocated to the same terminals consistently.

The best solution is for your application programs always to check before creating a temporary storage queue whether a queue of the same name already exists, and, if so, to delete it. This dispenses with the need for your autoinstall program to allocate TERMIDs consistently.

However, if your application programs do not already implement this check, it may not be possible to correct them all. In this case, your autoinstall program may need to use a mapping file, as described above.

- Whether your application programs record TERMIDs for later use. For example, an application might issue an EXEC CICS START TERMID command, with a time interval after which the transaction is to be initiated against the named

terminal. If, during the delay interval, the terminal definition is deleted, re-shipped, and re-installed with a different local TERMID, the started transaction could fail because the TERMID no longer exists.

If your application programs record TERMIDs in this way, your autoinstall program may need to use a mapping file.

### Example

Assume that you have two terminal-owning regions, TORA and TORB, and that they use the same set of terminal identifiers, T001 through T500. TORA and TORB route transactions to the same application-owning region, AOR1. To prevent naming conflicts when terminals are shipped to AOR1, your control program in AOR1 could:

- Accept the TERMIDs allocated by TORA. That is, leave the TERMINAL attribute of the remote definition set to the same as the REMOTENAME attribute.
- Create aliases for the TERMIDs allocated by TORB. That is, reset the TERMINAL attribute of the remote definition, using a mapping file as described above. For example, TERMIDs of T001 through T500 could be mapped to aliases of A001 through A500.

This solution allows two TORs using the same set of TERMIDs to access the same AOR. However, even though the aliases created in the AOR are mapped consistently to TERMIDs in the TOR, the solution does not *guarantee* that data mismatch problems cannot occur if terminals are re-shipped. This is because it relies on TERMIDs being allocated consistently *in the TOR*—that is, on specific TERMIDs always being assigned to the same physical devices.

**Note:** Your control program could use the correlation identifier contained in each terminal and connection definition to check whether a definition has been re-installed in the TOR—see the description of the `INSTALL_SHIPPED_CORRID_PTR` parameter in “The communications area at `INSTALL` for shipped terminals” on page 562.

A better solution might be to map the terminal alias in the AOR to the **netname** of the terminal. This would at least guarantee that a specific alias always relates to the same physical device. But it would still require TERMIDs for which aliases are *not* created to be consistently allocated in the TOR.

---

## The autoinstall control program at `INSTALL`

The autoinstall control program is invoked at `INSTALL` for:

- Local VTAM terminals
- MVS consoles
- Local APPC single-session connections initiated by a `CINIT`
- Local APPC parallel-session connections initiated by a `BIND`
- Local APPC single-session connections initiated by a `BIND`
- Client virtual terminals
- Remote shipped terminals and connections, including shipped definitions of Client virtual terminals.

On each invocation, CICS passes a parameter list to the control program by means of a communication area addressed by `DFHEICAP`. The parameter list passed at `INSTALL` of local terminals and APPC single-session connections initiated by `CINIT` is described in “The communication area at `INSTALL` for terminals” on page 518. The parameter list passed at `INSTALL` of MVS consoles is described in “The

autoinstall control program at INSTALL” on page 536. The parameter list passed at INSTALL of local APPC connections initiated by BIND requests is described in “The communication area at INSTALL for APPC connections” on page 545. The parameter list passed at INSTALL of Client virtual terminals is described in “The communications area at INSTALL for Client virtual terminals” on page 571. This section describes only INSTALL of shipped terminals and connections.

## The communications area at INSTALL for shipped terminals

The communications area is mapped by the DSECT for the assembler version of DFHZATDX, which is supplied in CICSTS32.CICS.SDFHMAC.

```

*-----*
* Remote install parameter list - Shipped definition functions 7 & 8 *
*-----*
INSTALL_SHIPPED_COMMAREA      DSECT          Install Parameter List
*
INSTALL_SHIPPED_STANDARD      DS  F           Standard field
                                ORG INSTALL_SHIPPED_STANDARD
INSTALL_SHIPPED_EXIT_FUNCTION DS  XL1           Install type
INSTALL_SHIPPED_TERM          EQU X'F7'       Install terminal
INSTALL_SHIPPED_RSE           EQU X'F8'       Install remote system entry
INSTALL_SHIPPED_EXIT_COMPONENT DS  CL2           Component ID 'ZC'
INSTALL_SHIPPED_CLASH         DS  CL1           Install clash Y/N
                                ORG ,
INSTALL_SHIPPED_NETNAME_PTR   DS  A           Pointer to netname
INSTALL_SHIPPED_SELECTED_PTR  DS  A           Pointer to return fields
INSTALL_SHIPPED_TERMID_PTR    DS  A           Pointer to incoming TERMID
INSTALL_SHIPPED_APPLID_PTR    DS  A           Pointer to applid of TOR
INSTALL_SHIPPED_SYSID_PTR     DS  A           Pointer to sysid
INSTALL_SHIPPED_CORRID_PTR    DS  A           Pointer to correlation ID
INSTALL_SHIPPED_SELECTED_PARMS DSECT ,
                                DS  CL8           Reserved
SELECTED_SHIPPED_TERMID       DS  CL4           Selected TERMID
SELECTED_SHIPPED_RETURN_CODE  DS  CL1           Selected return code
RETURN_OK                     EQU X'00'       Accept request
REJECT                         EQU X'01'       Reject request
*

```

Figure 51. Autoinstall control program’s communications area at INSTALL. For shipped terminals and connections.

### INSTALL\_SHIPPED\_STANDARD

A fullword input field containing the following information:

#### INSTALL\_SHIPPED\_EXIT\_FUNCTION

A 1-byte field that indicates the type of resource being installed. For install of remote terminals and connections the equated values are:

#### INSTALL\_SHIPPED\_TERM (X'F7')

A shipped terminal

#### INSTALL\_SHIPPED\_RSE (X'F8')

A shipped connection (remote system entry).

#### INSTALL\_SHIPPED\_EXIT\_COMPONENT

A 2-byte component code, which is set to 'ZC'.

### INSTALL\_SHIPPED\_CLASH

A 1-character input field that indicates whether the TERMID of the shipped definition is already in use in the AOR.

**Y** The name by which the terminal or connection is known in the TOR



(the value of the `TERMINAL` or `CONNECTION` attribute on the shipped definition) is already in use in the AOR to identify an installed remote terminal or connection.

**N** The name by which the terminal or connection is known in the TOR is not in use in the AOR to identify a remote terminal or connection.

**INSTALLED\_SHIPPED\_NETNAME\_PTR**

A fullword pointer to an 8-character input field containing the netname of the terminal or connection to be installed.

**INSTALL\_SHIPPED\_SELECTED\_PTR**

A fullword pointer to the return fields. The output fields, for use by your program, are:

**SELECTED\_SHIPPED\_TERMID**

A 4-character field used to specify the name by which the remote terminal or connection is to be known to this system. If the name is less than 4 characters long, it must be padded with trailing blanks. For a list of the characters you can use in terminal names, see Terminal definition attributes, in the *CICS Resource Definition Guide*.

On invocation, if `INSTALL_SHIPPED_CLASH` is set to 'N' (indicating no conflict of terminal names), `SELECTED_SHIPPED_TERMID` contains the same value as the field pointed to by `INSTALL_SHIPPED_TERMID_PTR` (the value of the `TERMINAL` or `CONNECTION` attribute on the shipped definition). If `INSTALL_SHIPPED_CLASH` is set to 'Y', `SELECTED_SHIPPED_TERMID` contains a CICS-generated alias.

Your user program can use this field to override a CICS-generated alias. For advice on choosing terminal and connection names, see "Resetting the terminal identifier" on page 560.

**SELECTED\_SHIPPED\_RETURN\_CODE**

The 1-character return code field. The equated values are:

**RETURN\_OK (X'00')**

Install the remote terminal or connection. Your user program must return this value if the resource is to be autoinstalled.

**REJECT (X'01')**

Do not install the remote terminal or connection. This is the default value.

**INSTALL\_SHIPPED\_TERMID\_PTR**

A fullword pointer to a 4-character input field containing the name by which the terminal or connection is known in the TOR. (This is the value of the `TERMINAL` or `CONNECTION` attribute on the shipped definition.)

**INSTALL\_SHIPPED\_APPLID\_PTR**

A fullword pointer to an 8-character input field containing the netname (applid) of the TOR.

**INSTALL\_SHIPPED\_SYSID\_PTR**

A fullword pointer to a 4-character input field containing the name (sysid) of the connection to the TOR.

**INSTALL\_SHIPPED\_CORRID\_PTR**

A fullword pointer to an 8-character input field containing the shipped definition's *correlation identifier*. A correlation identifier is a unique "instance token" that is created when a CICS/ESA 4.1 or later terminal or connection definition is

installed, and stored within the definition. Thus, if the definition is shipped to another region, the value of the token is shipped too. The correlation ID is used by CICS during attach processing, to check whether existing shipped definitions in an AOR are up-to-date, or whether they need to be deleted and reshipped because the terminal has been re-installed in the TOR. For further information about instance tokens, see Efficient deletion of shipped terminal definitions, in the *CICS Intercommunication Guide*.

If your control program maps TOR-allocated TERMIDs to the aliases that it assigns in the AOR, by recording correlation IDs it could check whether a terminal has been re-installed in the TOR. If the terminal *has* been re-installed, it is possible that the TOR-allocated TERMID relates to a *different* physical device from that last installed under this TERMID.

---

## The autoinstall control program at DELETE

The autoinstall control program is reinvoked when an autoinstalled resource is deleted. (The resources that can be autoinstalled are listed under “The autoinstall control program at INSTALL” on page 561.) Invoking the user program at DELETE enables you to reverse the processes carried out at INSTALL.

The parameter list passed to your user program at DELETE of local terminals is described on page “The autoinstall control program at DELETE” on page 525. The parameter list passed at DELETE of local APPC connections is described on page “The autoinstall control program at DELETE” on page 549. The parameter list passed at DELETE of Client virtual terminals is described on page “The autoinstall control program at DELETE” on page 575. This section describes only DELETE of shipped terminals and connections.

Shipped terminal and connection definitions are deleted by the CICS Transaction Server for z/OS, Version 3 Release 2 timeout delete mechanism. For details of the timeout delete mechanism, see Efficient deletion of shipped terminal definitions, in the *CICS Intercommunication Guide*.

Figure 52 shows the communications area passed to the autoinstall user program at DELETE.

DELETE_SHIPPED_COMMAREA	DSECT ,	Delete parameter list
DELETE_SHIPPED_STANDARD	DS F	Standard field
DELETE_SHIPPED_EXIT_FUNCTION	DS XL1	Delete type
DELETE_SHIPPED_TERM	EQU X'FA'	Delete terminal
DELETE_SHIPPED_RSE	EQU X'FB'	Delete remote system entry
DELETE_SHIPPED_EXIT_COMPONENT	DS CL2	Component ID 'ZC'
	DS CL1	Reserved
DELETE_SHIPPED_TERMID	DS CL4	TERMID in TOR
DELETE_SHIPPED_APPLID	DS CL8	Applid of TOR
DELETE_SHIPPED_LTERMID	DS CL4	TERMID in AOR
DELETE_SHIPPED_NETNAME	DS CL8	Netname of terminal

Figure 52. Autoinstall control program's communications area at DELETE. For shipped terminals and connections.

At DELETE, all fields in the communications area are input only. Fields not listed below are as described for INSTALL.

### DELETE\_SHIPPED\_EXIT\_FUNCTION

A 1-byte field that indicates the type of resource being deleted. The equated values are:

**DELETE\_SHIPPED\_TERM (X'FA')**

A shipped terminal

**DELETE\_SHIPPED\_RSE (X'FB')**

A shipped connection (remote system entry).

**DELETE\_SHIPPED\_TERMID**

A 4-character field containing the identifier (TERMID) of the terminal or connection in the TOR.

**DELETE\_SHIPPED\_APPLID**

An 8-character field containing the netname (applid) of the TOR.

**DELETE\_SHIPPED\_LTERMID**

A 4-character field containing the name by which the terminal or connection is known in the AOR. This may or may not be the same as DELETE\_SHIPPED\_TERMID, depending on whether an alias has been used in the AOR.

**DELETE\_SHIPPED\_NETNAME**

An 8-character field containing the netname of the terminal being deleted.

---

## Default actions of the sample programs

When DFHZATDX or DFHZATDY is invoked at INSTALL of a shipped terminal or connection, it:

1. Updates, if necessary, the SELECTED\_SHIPPED\_TERMID field, so that it contains the name by which the terminal or connection is known in the TOR.

**Note:**

- a. If CICS detected a conflict with a currently-installed remote TERMID, on invocation of the sample programs SELECTED\_SHIPPED\_TERMID contains a CICS-generated alias. The sample programs overwrite this value.
  - b. If CICS detected no conflict with a currently-installed remote TERMID, on invocation of the sample programs SELECTED\_SHIPPED\_TERMID contains the value of the TERMINAL attribute on the shipped definition (the value pointed to by INSTALL\_SHIPPED\_TERMID\_PTR). The sample programs accept this value.
2. Permits the remote definition to be installed by setting the return code field to RETURN\_OK, and returning.

When DFHZATDX or DFHZATDY is invoked at DELETE of a shipped terminal or connection, it takes no action and returns.



---

## Chapter 15. Writing a program to control autoinstall of virtual terminals

Virtual terminals are used by the External Presentation Interface (EPI) and terminal emulator functions of the CICS Clients products, as well as the CICS Link3270 bridge.

In a bridged environment, these virtual terminals replace the real 3270 that is the principal facility of a 3270 transaction. They are known as bridge facilities.

Both the supplied autoinstall control programs, DFHZATDX and DFHZATDY, provide function to install definitions of virtual terminals. You can therefore base your customized control program on either DFHZATDX or DFHZATDY.

This information is divided into the following sections:

1. "How Client virtual terminals are autoinstalled"
2. "The autoinstall control program at INSTALL" on page 571
3. "The autoinstall control program at DELETE" on page 575
4. "Default actions of the sample programs" on page 577.

---

### How Client virtual terminals are autoinstalled

Client virtual terminals are defined to CICS Transaction Server for z/OS, Version 3 Release 2 as remote 3270 datastream devices.

### Autoinstall models

The autoinstall model used to install a virtual terminal is determined using the following sequence:

1. **For EPI programs:** From the **DevType** parameter of the **CICS\_EpiAddTerminal** function, if specified by the Client EPI program. (For details of EPI calls, see the *CICS Family: Client/Server Programming* manual.)

**For the Client terminal emulator:** From the **/m** parameter of the **cicsterm** command used to start the emulator, if specified by the workstation user. (For details of the **cicsterm** command, see the *CICS Clients: Administration* manual.)

**Note:** Any autoinstall models specified by Clients must, of course, be defined to CICS. However, because VTAM definitions are not required for Client virtual terminals, there is no need to create matching entries in the VTAM LOGMODE table.

2. The CICS-supplied autoinstall model, DFHLU2.

The autoinstall control program cannot choose a different autoinstall model.

### Terminal identifiers

The terminal identifier (TERMID) passed to the CICS autoinstall function at install of a virtual terminal is determined using the following sequence:

1. For EPI programs: From the **NetName** parameter of the **CICS\_EpiAddTerminal** function, if specified by the Client EPI program.

For the Client terminal emulator: From the **/n** parameter of the **cicsterm** command used to start the emulator, if specified by the workstation user.

2. A name generated automatically by CICS.

TERMIDs generated by CICS for Client terminals consist of a 1-character prefix and a 3-character suffix. The default prefix is '\', but you can specify a different prefix using the **VTPREFIX** system initialization parameter. The suffix can have the values 'AAA' through '999'. That is, each character in the suffix can have the value 'A' through 'Z' or '0' through '9'. The first suffix generated by CICS has the value 'AAA'. This is followed by 'AAB', 'AAC', ... 'AAZ', 'AA0', 'AA1', and so on, up to '999'.

Each time a Client virtual terminal is autoinstalled, CICS generates a 3-character suffix that it has not recorded as being in use.

**Note:** By specifying a prefix, you can ensure that the TERMIDs of Client terminals autoinstalled on this system are unique in your transaction routing network. This prevents the conflicts that could occur if two or more regions ship definitions of virtual terminals to the same application-owning region (AOR).

For details of the **VTPREFIX** system initialization parameter, see the *CICS System Definition Guide*.

For brevity, we shall refer to the name specified by the Client or the CICS-generated “VTPREFIX” name as the supplied name. The Client always knows the virtual terminal by the supplied name. However, your autoinstall control program can allocate an alias, by which the virtual terminal will be known to CICS.

If the CICS autoinstall function detects that the supplied name clashes with the name of a remote terminal or connection already installed on this region, it generates an alias TERMID. CICS generates alias TERMIDs for virtual terminals in the same way as it generates aliases for shipped terminals—see “CICS-generated aliases” on page 560.

**Note:** If the supplied name clashes with the name of a local terminal or connection, the install of the virtual terminal is rejected, and the autoinstall control program is not invoked.

The autoinstall control program is invoked once for each virtual terminal definition to be installed. When it is invoked, field `INSTALL_SHIPPED_TERMID_PTR` of the communications area points to the supplied TERMID. Field `SELECTED_SHIPPED_TERMID` contains either the supplied TERMID, or a CICS-generated alias, depending on whether a clash of names has been detected.

Your control program can accept the TERMID passed in `SELECTED_SHIPPED_TERMID`, change it, or reject the installation of the virtual terminal.

## Why override TERMIDs?

Why might you want to create an alias for the supplied TERMID (or, in the case of a clash of names, to override the alias generated by CICS)? You may not need to; it may depend on the way in which your server programs are written. By “server programs” we mean both the transaction programs started by Client EPI programs, and those started from the Client terminal emulator.

### Overriding CICS-generated TERMIDs

If you are using CICS-generated TERMIDs (and have specified a different prefix, reserved for virtual terminals, on each region on which Client terminals can be installed), there should be no clash of names, either in the regions in which the virtual terminals are installed, or when different regions ship Client definitions to the

same AOR. However, if you are using CICS-generated TERMIDs, your server programs must not rely on TERMIDs being allocated consistently to particular Client terminals.

A Client terminal can be deleted by a Client sending a **CICS\_EpiDelTerminal** request, by an end user shutting down a Client terminal emulator or the Client itself, or if a connection failure occurs.<sup>3</sup> When it is reinstalled, CICS does not necessarily generate the same TERMID as it had previously. This could create problems if, for example:

- Your server programs derive temporary storage queue names from the TERMID (to associate each queue with a particular end user). Problems of data mismatch could occur if the queue is not deleted by transaction end (possibly due to a failure).

The best solution is for your application programs always to check before creating a temporary storage queue whether a queue of the same name already exists, and, if so, to delete it. However, if you have a large number of server applications, it may not be possible to check or change them all.

- Your server programs record TERMIDs for later use. For example, an application might issue an EXEC CICS START TERMID command, with a time interval after which the transaction is to be initiated against the named terminal. If, during the delay interval, the virtual terminal is deleted, and re-installed with a different TERMID, the started transaction could fail because the TERMID no longer exists.

If your server programs cannot be rewritten, it may be necessary for your autoinstall control program to create aliases for the CICS-generated TERMIDs. It could, for example, use a mapping file to relate particular aliases to particular Client workstations (identified by connection name).

If your server programs are located on a back-end AOR, the autoinstall control program is invoked in the AOR when a virtual terminal is shipped in, just as for any other shipped definition. It can, if necessary, allocate an alias terminal identifier to the shipped definition. (For details of writing a control program to install shipped definitions, see Chapter 14, "Writing a program to control autoinstall of shipped terminals," on page 559.)

### **Overriding Client-specified TERMIDs**

If TERMIDs are always nominated, in a consistent way, by your Client EPI programs, the problem of data mismatch due to server programs recording TERMIDs should not occur.

However, Client-specified TERMIDs could clash with non-Client remote TERMIDs; or, if several Clients are attached to the same CICS system, with each other. If this occurs in the region on which the CTIN transaction runs, for consistency your autoinstall control program may need to allocate alias TERMIDs, rather than relying on the aliases provided by CICS. (That is, it may need to relate particular TERMIDs to particular Client workstations, as previously described.)

---

3. Definitions of Client virtual terminals are **not** deleted by the CICS Transaction Server for z/OS, Version 3 Release 2 timeout delete mechanism that operates on shipped terminal definitions. That is, the timeout delete mechanism does not operate on the (remote) definitions of Client terminals on the CICS Transaction Server for z/OS, Version 3 Release 2 system on which the install Client terminal transaction (CTIN) runs. It does operate on Client definitions that are shipped to a back-end CICS/ESA 4.1 or later system.

If a name clash occurs in an AOR, the autoinstall control program is invoked in the AOR. It can resolve the conflict by allocating an alias terminal identifier to the shipped definition.

---

## How bridge facility virtual terminals are autoinstalled

Bridge facility virtual terminals are defined to CICS Transaction Server for z/OS, Version 3 Release 2 as LU2 devices. They are created by the 3270 bridge mechanism to support the execution of a CICS 3270 application in a bridged environment, where all terminal interaction is intercepted and passed to the 3270 bridge mechanism.

The 3270 bridge mechanism uses a model 3270 terminal definition (*facilitylike*) to build the bridge facility, creating both an eight-byte token to identify it and a four-character terminal identifier, which is used as both TERMID and NETNAME.

For bridge facilities created with the START BREXIT command, the token and name are unique within the region creating the bridge facility, and the TERMID takes the form }AAA, where AAA is an alphabetic sequence that ascends serially.

For bridge facilities created by the Link3270 bridge, the token and name are unique across the CICSplex, and the TERMID is of the form AAA}. Uniqueness is achieved by using a shared file to control allocation of names.

Bridge facility terminal names and netnames are normally allocated dynamically by the bridge mechanism, but if the AIBRIDGE system initialization parameter is set to YES, the terminal autoinstall control program is called and can be used to assign installation specific names.

## Using the terminal autoinstall control program for bridge facilities

If you specify AIBRIDGE (YES), then the autoinstall control program is called when a bridge facility is allocated or deleted. The autoinstall control program is passed a parameter list ( the communications area) described in “The communications area at INSTALL for bridge facility virtual terminals” on page 573 and “The communications area at DELETE for bridge facility virtual terminals” on page 576. This indicates whether the program was called for a Link3270 or a START bridge facility.

Installation specific terminal names can be allocated in one of two ways:

1. Names can be defined by the client program and passed on the initial Link3270 request. The autoinstall control program can then allow, change or reject these names.
2. Names can be defined by the autoinstall control program

The names suggested by the client program are passed in the communications area. The autoinstall control program can also use EXEC CICS ASSIGN USERID to obtain the USERID and use this to validate the suggested TERMID and NETNAME.

The client defined TERMID and NETNAME fields can also be used to pass some installation specific data to the autoinstall control program, to be used to generate the required names.

### Autoinstall of a START bridge facility

Apart from the information contained in the communications area, you can obtain the following information:



- The USERID of the first transaction in a pseudoconversation can be obtained using EXEC CICS ASSIGN USERID.
- The TRANSID of the first transaction in a pseudoconversation can be obtained from EIBTRNID.

The autoinstall control program can use the USERID and TRANSID values to derive new TERMID and NETNAME values and return them in the communications area.

## **Autoinstall of a Link3270 bridge facility**

### **Bridge facility name uniqueness**

Some applications use the termid to allocate a unique resource. This relies on the name being unique within the CICSplex<sup>®</sup>. Bridge facility names have the same namespace as termids. However, CICS is unable to ensure that the bridge facility name returned by the autoinstall control program is not the same as a termid somewhere in the CICSplex. Neither the termid nor netname returned by the autoinstall control program are validated.

---

## **The autoinstall control program at INSTALL**

The autoinstall control program is invoked at INSTALL for:

- Local VTAM terminals
- MVS consoles
- Local APPC single-session connections initiated by a CINIT
- Local APPC parallel-session connections initiated by a BIND
- Local APPC single-session connections initiated by a BIND
- Client virtual terminals
- Bridge facility virtual terminals
- Remote shipped terminals and connections (including shipped definitions of Client virtual terminals).

On each invocation, CICS passes a parameter list to the control program by means of a communication area addressed by DFHEICAP. The parameter list passed at INSTALL of local terminals and APPC single-session connections initiated by CINIT is described in “The communication area at INSTALL for terminals” on page 518. The parameter list passed at INSTALL of local APPC connections initiated by BIND requests is described in “The communication area at INSTALL for APPC connections” on page 545. The parameter list passed at INSTALL of MVS consoles is described in “The autoinstall control program at INSTALL” on page 536. The parameter list passed at INSTALL of shipped terminals and connections is described in “The communications area at INSTALL for shipped terminals” on page 562. This section describes only parameters passed at INSTALL of Client virtual terminals, in “The communications area at INSTALL for Client virtual terminals,” and of bridge facilities in “The communications area at INSTALL for bridge facility virtual terminals” on page 573.

### **The communications area at INSTALL for Client virtual terminals**

The communications area is mapped by the DSECT for the assembler version of DFHZATDX or DFHZATDY, which are supplied in CICSTS32.CICS.SDFHMAC.

**Note:** The communications area for INSTALL of virtual terminals is the same as that for INSTALL of shipped terminals and connections—that is why the field names contain the word “SHIPPED”.

```

*-----*
* Remote install parameter list - Client virtual terminal function 9 *
*-----*
INSTALL_SHIPPED_COMMAREA      DSECT      Install Parameter List
*
INSTALL_SHIPPED_STANDARD     DS F        Standard field
                                ORG INSTALL_SHIPPED_STANDARD
INSTALL_SHIPPED_EXIT_FUNCTION DS XL1       Install type
INSTALL_SHIPPED_TERM         EQU X'F9'   Install virtual terminal
INSTALL_SHIPPED_EXIT_COMPONENT DS CL2       Component ID 'ZC'
INSTALL_SHIPPED_CLASH        DS CL1       Install clash Y/N
                                ORG ,
INSTALL_SHIPPED_NETNAME_PTR   DS A        Pointer to netname of Client
INSTALL_SHIPPED_SELECTED_PTR  DS A        Pointer to return fields
INSTALL_SHIPPED_TERMID_PTR   DS A        Pointer to incoming TERMID
INSTALL_SHIPPED_APPLID_PTR    DS A        Pointer to applid of Client
INSTALL_SHIPPED_SYSID_PTR     DS A        Pointer to sysid of Client
INSTALL_SHIPPED_CORRID_PTR    DS A        Pointer to correlation ID
INSTALL_SHIPPED_SELECTED_PARMS DSECT ,
                                DS CL8       Reserved
SELECTED_SHIPPED_TERMID      DS CL4       Selected TERMID
                                DS CL4       Reserved
                                DS CL4       Reserved
SELECTED_SHIPPED_RETURN_CODE  DS CL1       Selected return code
RETURN_OK                     EQU X'00'     Accept request
REJECT                         EQU X'01'     Reject request
*

```

Figure 53. Autoinstall control program's communications area at INSTALL. For Client virtual terminals.

**INSTALL\_SHIPPED\_STANDARD**

A fullword input field containing the following information:

**INSTALL\_SHIPPED\_EXIT\_FUNCTION**

A 1-byte field that indicates the type of resource being installed. For install of Client virtual terminals the equated value is INSTALL\_SHIPPED\_TERM (X'F7').

**INSTALL\_SHIPPED\_EXIT\_COMPONENT**

A 2-byte component code, which is set to 'ZC'.

**INSTALL\_SHIPPED\_CLASH**

A 1-character input field that indicates whether the supplied TERMID is already in use in this region.

**Y** The name passed to the CICS autoinstall function is already in use in this region to identify an installed remote terminal or connection.

**N** The name passed to the CICS autoinstall function is not already in use in this region to identify a remote terminal or connection.

**INSTALL\_SHIPPED\_NETNAME\_PTR**

A fullword pointer to an 8-character field containing the netname of the Client workstation. This field contains the same value as the field pointed to by INSTALL\_SHIPPED\_APPLID\_PTR.

**INSTALL\_SHIPPED\_SELECTED\_PTR**

A fullword pointer to the return fields. The output fields, for use by your program, are:

### **SELECTED\_SHIPPED\_TERMID**

A 4-character field used to specify the name by which the virtual terminal will be known to CICS. If the name is less than 4 characters long, it must be padded with trailing blanks. For a list of the characters you can use in terminal names, see Terminal definition attributes, in the *CICS Resource Definition Guide*.

On invocation, if `INSTALL_SHIPPED_CLASH` is set to 'N' (indicating no conflict of terminal names), `SELECTED_SHIPPED_TERMID` contains the same value as the field pointed to by `INSTALL_SHIPPED_TERMID_PTR` (the supplied name). If `INSTALL_SHIPPED_CLASH` is set to 'Y', `SELECTED_SHIPPED_TERMID` contains a CICS-generated alias.

Your user program can override the suggested name.

### **SELECTED\_SHIPPED\_RETURN\_CODE**

The 1-character return code field. The equated values are:

#### **RETURN\_OK (X'00')**

Install the virtual terminal. This is the default value. Your user program must return this value if the resource is to be autoinstalled.

#### **REJECT (X'01')**

Do not install the virtual terminal.

### **INSTALL\_SHIPPED\_TERMID\_PTR**

A fullword pointer to a 4-character input field containing the `TERMID` passed to the CICS autoinstall function (that is, the supplied name).

### **INSTALL\_SHIPPED\_APPLID\_PTR**

A fullword pointer to an 8-character input field containing the netname (applid) of the Client workstation.

### **INSTALL\_SHIPPED\_SYSID\_PTR**

A fullword pointer to a 4-character input field containing the name (sysid) of the connection to the Client workstation.

### **INSTALL\_SHIPPED\_CORRID\_PTR**

A fullword pointer to an 8-character input field that is not used for install of virtual terminals.

## **The communications area at `INSTALL` for bridge facility virtual terminals**

The communications area is mapped by the `DSECT` for the assembler version of `DFHZATDX` or `DFHZATDY`, which are supplied in `CICSTS32.CICS.SDFHMAC`.

```

-----
* Install Bridge Facility                                - Function 15 & 17
*-----*
INSTALL_BRFAC_COMMAREA      DSECT      Install Parameter List
INSTALL_BRFAC_STANDARD      DS  F          Standard field
                              ORG INSTALL_BRFAC_STANDARD
INSTALL_BRFAC_EXIT_FUNCTION DS  XL1         Install type
INSTALL_LINK_BRFAC          EQU X'0F'     Install Link Brfacility
INSTALL_START_BRFAC         EQU X'11'     Install Start Brfacility
INSTALL_BRFAC_EXIT_COMPONENT DS  CL2       Component ID 'BR'
                              DS  CL1       Reserved
                              ORG ,
INSTALL_BRFAC_NETNAME_PTR   DS  A          Pointer to input netname
INSTALL_BRFAC_SELECTED_PTR  DS  A          Pointer to return fields
INSTALL_BRFAC_TERMID_PTR    DS  A          Pointer to input termid
                              DS  A          Reserved
                              DS  A          Reserved
                              DS  A          Reserved
INSTALL_BRFAC_SELECTED_PARMS DSECT ,
                              DS  CL8       Reserved
SELECTED_BRFAC_TERMID       DS  CL4       Selected termid
SELECTED_BRFAC_RETURN_CODE  DS  B          Selected return
SELECTED_BRFAC_NETNAME     DS  CL8       Selected netname
*
*-----*

```

Figure 54. Autoinstall control program's communications area at INSTALL. For bridge facilities.

#### **INSTALL\_BRFAC\_STANDARD**

A fullword input field containing the following information:

#### **INSTALL\_BRFAC\_EXIT\_FUNCTION**

A 1-byte field that indicates the type of resource being installed. For install of bridge facility virtual terminals. The equated values are:

#### **INSTALL\_LINK\_BRFAC (X'0F')**

The autoinstall program was called during installation of a bridge facility to be used by the Link3270 bridge.

#### **INSTALL\_START\_BRFAC (X'11')**

The autoinstall program was called during installation of a bridge facility to be used by the START bridge.

#### **INSTALL\_BRFAC\_EXIT\_COMPONENT**

A 2-byte component code, which is set to 'BR'.

#### **INSTALL\_BRFAC\_NETNAME\_PTR**

A fullword pointer to an 8-character field containing the netname of the bridge facility. This is either the value specified by the client or the value generated by CICS if the client specifies BRIHNN-DEFAULT (the default value).

#### **INSTALL\_BRFAC\_SELECTED\_PTR**

A fullword pointer to the return fields. The output fields, for use by your program, are:

#### **SELECTED\_BRFAC\_TERMID**

A 4-character field used to specify the name by which the virtual terminal will be known to CICS. If the name is less than 4 characters long, it must be padded with trailing blanks. For a list of the characters you can use in terminal names, see Terminal definition attributes, in the *CICS Resource Definition Guide*. You can copy the name in INSTALL\_BRFAC\_TERMID\_PTR, or set a new value.

#### **SELECTED\_BRFAC\_RETURN\_CODE**

The 1-character return code field. The equated values are:

**RETURN\_OK (X'00')**

Install the virtual terminal. This is the default value. Your user program must return this value if the resource is to be autoinstalled.

**REJECT (X'01')**

Do not install the virtual terminal.

**SELECTED\_BRFAC\_NETNAME**

An 8-character field used to specify the netname of the bridge facility. If the name is less than 8 characters long, it must be padded with trailing blanks. You can copy the name in `INSTALL_BRFAC_NETNAME_PTR`, or set a new value.

**INSTALL\_BRFAC\_TERMID\_PTR**

A fullword pointer to a 4-character input field containing the `TERMID` passed to the CICS autoinstall function (that is, the supplied name).

## The autoinstall control program at DELETE

The autoinstall control program is reinvoked when an autoinstalled resource is deleted. (The resources that can be autoinstalled are listed under “The autoinstall control program at `INSTALL`” on page 571.) Invoking the user program at `DELETE` enables you to reverse the processes carried out at `INSTALL`.

The parameter list passed to your user program at `DELETE` of local terminals is described on page “The autoinstall control program at `DELETE`” on page 525. The parameter list passed at `DELETE` of local APPC connections is described on page “The autoinstall control program at `DELETE`” on page 549. The parameter list passed at `DELETE` of shipped definitions is described on page “The autoinstall control program at `DELETE`” on page 564. This section describes `DELETE` of Client virtual terminals at “The communications area at `DELETE` for Client virtual terminals” and bridge facility virtual terminals at “The communications area at `DELETE` for bridge facility virtual terminals” on page 576.

Shipped terminal and connection definitions are deleted by the CICS Transaction Server for z/OS, Version 3 Release 2 timeout delete mechanism. For details of the timeout delete mechanism, see Efficient deletion of shipped terminal definitions, in the *CICS Intercommunication Guide*.

## The communications area at DELETE for Client virtual terminals

The communications area passed to the autoinstall user program at `DELETE`.

<code>DELETE_SHIPPED_COMMAREA</code>	<code>DSECT ,</code>	Delete parameter list
<code>DELETE_SHIPPED_STANDARD</code>	<code>DS F</code>	Standard field
<code>DELETE_SHIPPED_EXIT_FUNCTION</code>	<code>DS XL1</code>	Delete type
<code>DELETE_SHIPPED_TERM</code>	<code>EQU X'FC'</code>	Delete virtual terminal
<code>DELETE_SHIPPED_EXIT_COMPONENT</code>	<code>DS CL2</code>	Component ID 'ZC'
	<code>DS CL1</code>	Reserved
<code>DELETE_SHIPPED_TERMID</code>	<code>DS CL4</code>	<code>TERMID</code>
<code>DELETE_SHIPPED_APPLID</code>	<code>DS CL8</code>	Applid of Client workstation
<code>DELETE_SHIPPED_LTERMID</code>	<code>DS CL4</code>	<code>TERMID</code> in this region
<code>DELETE_SHIPPED_NETNAME</code>	<code>DS CL8</code>	Netname of Client workstation

Figure 55. Autoinstall control program's communications area at `DELETE`. For Client virtual terminals.

At `DELETE`, all fields in the communications area are input only. Fields not listed below are as described for `INSTALL`.

#### DELETE\_SHIPPED\_EXIT\_FUNCTION

A 1-byte field that indicates the type of resource being deleted. The equated value for Client virtual terminals is DELETE\_SHIPPED\_TERM (X'FC').

**Note:** A value of X'F1' represents the deletion of a local terminal, or an APPC single-session device that was autoinstalled via a CINIT request—see page “The autoinstall control program at DELETE” on page 525. A value of X'F5' or X'F6' represents the deletion of an APPC connection that was installed by a BIND request—see page “The autoinstall control program at DELETE” on page 549. A value of X'FA' or X'FB' represents the deletion of a shipped terminal or connection—see page Figure 52 on page 564.

#### DELETE\_SHIPPED\_TERMID

A 4-character field containing the name by which the virtual terminal is known to the Client.

#### DELETE\_SHIPPED\_APPLID

An 8-character field containing the netname (applid) of the Client workstation.

#### DELETE\_SHIPPED\_LTERMID

A 4-character field containing the name by which the virtual terminal is known in this region. This may or may not be the same as the value in DELETE\_SHIPPED\_TERMID, depending on whether an alias was used at install.

#### DELETE\_SHIPPED\_NETNAME

An 8-character field containing the netname of the Client workstation. This field contains the same value as DELETE\_SHIPPED\_APPLID.

## The communications area at DELETE for bridge facility virtual terminals

The communications area passed to the autoinstall user program at DELETE.

```
*
*-----*
* Delete Bridge Facility - Function 16 *
*-----*
DELETE_BRFAC_COMMAREA      DSECT , Delete parameter list
DELETE_BRFAC_STANDARD      DS F Standard field
                           ORG DELETE_BRFAC_STANDARD
DELETE_BRFAC_EXIT_FUNCTION DS XL1 Delete type
DELETE_LINK_BRFAC          EQU X'10' Delete Link Brfacility
DELETE_START_BRFAC        EQU X'12' Delete Start Brfacility
DELETE_BRFAC_EXIT_COMPONENT DS CL2 Component ID 'BR'
                           DS CL1 Reserved
DELETE_BRFAC_TERMID       DS CL4 Termid
                           DS CL8 Reserved
                           DS CL4 Reserved
DELETE_BRFAC_NETNAME      DS CL8 Netname of terminal
```

Figure 56. Autoinstall control program's communications area at DELETE. For bridge facility virtual terminals.

At DELETE, all fields in the communications area are input only. Fields not listed below are as described for INSTALL.

#### DELETE\_BRFAC\_EXIT\_FUNCTION

A 1-byte field that indicates the type of resource being deleted. For deletion of bridge facility virtual terminals. The equated values are:

**INSTALL\_LINK\_BRFAC (X'10')**

The autoinstall program was called during installation of a bridge facility to be used by the Link3270 bridge.

**INSTALL\_START\_BRFAC (X'12')**

The autoinstall program was called during installation of a bridge facility to be used by the START bridge.

**DELETE\_BRFAC\_EXIT COMPONENT**

A 2-byte component code, which is set to 'BR'

**DELETE\_BRFAC\_TERMID**

A 4-character field containing the bridge facility name.

**DELETE\_BRFAC\_NETNAME**

An 8-character field containing the netname of the bridge facility.

---

## Default actions of the sample programs

When DFHZATDX or DFHZATDY is invoked at INSTALL of a Client virtual terminal, it:

1. Accepts the terminal name placed by CICS in `SELECTED_SHIPPED_TERMID`.  
If CICS detected no conflict with a currently-installed remote `TERMID`, `SELECTED_SHIPPED_TERMID` contains the value pointed to by `INSTALL_SHIPPED_TERMID_PTR` (that is, the name specified by the Client, or the "VTPREFIX" name generated by CICS).  
If CICS detected a conflict with a currently-installed remote `TERMID`, `SELECTED_SHIPPED_TERMID` contains a CICS-generated alias.
2. Permits the remote definition to be installed by leaving the return code field set to its default value of `RETURN_OK`, and returning.

When DFHZATDX or DFHZATDY is invoked at DELETE of a Client virtual terminal, it takes no action and returns.





---

## Chapter 16. Writing a program to control autoinstall of programs

### Considerations common to all user-replaceable programs

Note that the comments contained in Chapter 5, “General notes about user-replaceable programs,” on page 435 apply to this chapter.

This chapter describes the user-replaceable program that controls the automatic installation of programs, mapsets, and partitionsets.

**Note:** In this chapter, the term “program autoinstall” is used to mean autoinstall of all three program types (program, mapset, and partitionset) unless otherwise specified.

The chapter is divided into the following sections:

1. “Autoinstalling programs—preliminary considerations”
2. “Benefits of autoinstalling programs” on page 581
3. “Requirements for program autoinstall” on page 582
4. “The autoinstall control program at INSTALL” on page 583
5. “The sample autoinstall control program for programs, DFHPGADX” on page 586.

---

### Autoinstalling programs—preliminary considerations

As well as terminals and APPC connections, you can autoinstall:

- User programs
- Mapsets
- Partitionsets.

If the autoinstall program function is enabled, and an implicit or explicit load request is issued for a previously undefined program, mapset, or partitionset, CICS dynamically creates a definition, and installs and catalogs it, as appropriate. An implicit or explicit load occurs when:

- CICS starts a transaction.
- An application program issues one of the following commands:
  - EXEC CICS LINK—see “Autoinstalling programs invoked by EXEC CICS LINK commands” on page 580
  - EXEC CICS XCTL
  - EXEC CICS LOAD
  - EXEC CICS ENABLE (for a global user exit, or task-related user exit, program)
  - EXEC CICS RECEIVE or SEND MAP
  - EXEC CICS SEND PARTNSET
  - EXEC CICS RECEIVE PARTN
  - A dynamic COBOL call
- A program abend occurs, and CICS transfers control to the program named on an EXEC CICS HANDLE ABEND command.

- CICS calls any user-replaceable program other than the program or terminal autoinstall program.
- A program is named in the PLTPI or PLTSD list.

## Autoinstall model definitions

Like autoinstall for terminals, program autoinstall uses model definitions, together with a user-replaceable control program, to create explicit definitions for resources that need to be autoinstalled. The purpose of a model is to provide CICS with a definition that can be used for all programs with the same properties. CICS calls the autoinstall control program with a parameter list that includes the name of a CICS-supplied, default model definition appropriate to the program type (program, mapset, or partitionset). Your autoinstall control program can accept the default model, or specify another (any installed program definition can be used as a model). It can also specify explicitly any properties that are unique to a program, thus overriding those specified on the model definition. It can specify that a local or a remote definition should be installed.

On return from the control program, CICS creates a resource definition from the model and properties returned in the parameter list.

For CICS programs, mapsets, or partitionsets (that is, for any objects that begin with the letters "DFH"), CICS uses the default model definitions, but does **not** call the user-replaceable autoinstall control program. If you have your own autoinstall control program, you cannot use it to change the resource definitions for objects that begin with the letters "DFH".

## Autoinstalling programs invoked by EXEC CICS LINK commands

Distributed program link (DPL) requests can be dynamically routed. (For information about the dynamic routing of DPL requests, see *Which requests can be dynamically routed?*, in the *CICS Intercommunication Guide*.) This section describes the relationship between the autoinstall control program and the dynamic routing program.

When the autoinstall control program is invoked because there is no installed definition of a program named on an EXEC CICS LINK command without a SYSID, it can install:

### A local definition of the server program

CICS runs the server program on the local region.

### A definition that specifies REMOTESYSTEM(remote\_region) and DYNAMIC(NO)

CICS ships the LINK request to the remote region.

### A definition that specifies DYNAMIC(YES)

CICS invokes the dynamic routing program to route the LINK request.

**Note:** The DYNAMIC attribute takes precedence over the REMOTESYSTEM attribute. Thus, a definition that specifies both REMOTESYSTEM(remote\_region) and DYNAMIC(YES) defines the program as dynamic, rather than as residing on a particular remote region. (In this case, the REMOTESYSTEM attribute names the default server region passed to the dynamic routing program.)

### No definition of the server program

CICS invokes the dynamic routing program to route the LINK request.

**Note:** This assumes that the autoinstall control program *chooses* not to install a definition. If no definition is installed because autoinstall fails, the dynamic routing program is not invoked.

## Autoinstall processing of mapsets

Table 30 shows the differences in mapset processing between CICS regions with program autoinstall active and inactive.

Table 30. Differences in mapset processing between autoinstall and non-autoinstall

Program autoinstall INACTIVE	Program autoinstall ACTIVE
CSD definition is required. CICS attempts to load a referenced mapset with a suffix. If this fails, CICS tries an unsuffixed version. If that is unsuccessful, abend APCT is issued.	CSD definition is not required. Using autoinstall, CICS attempts to load the referenced suffixed mapset or partitionset, then the unsuffixed one. (In each case, a definition is autoinstalled.) The transaction requesting the resource abends only if no version of the resource exists in the library, either suffixed or unsuffixed.  If the suffixed mapset was not found in the library, the definition is marked 'not loadable'.

## System autoinstall

Some programs are autoinstalled automatically (if they have not been statically defined) by the CICS **system autoinstall** function, which does not require model definitions or the support of the autoinstall control program. Programs in this category include:

- First phase program list table post initialization (PLTPI) programs (that is, PLTPI programs that are defined *before* the PLT table delimiter DFHDELIM).
- Second phase program list table shutdown (PLTSD) programs (that is, PLTSD programs that are defined *after* the PLT table delimiter DFHDELIM).

**Note:** PLTPI programs that are defined *after* DFHDELIM, and PLTSD programs that are defined *before* DFHDELIM, are treated like any other user programs—they are eligible for program autoinstall.

---

## Benefits of autoinstalling programs

Program autoinstall reduces system administration, virtual storage usage, and, potentially, restart times.

### Reduced system administration costs

Without autoinstall, you have to define all new programs, mapsets, and partitionsets to CICS before they can be used. Autoinstall eliminates this requirement, enabling these resources to be used without prior definition. Furthermore, the need to maintain predefined definitions also disappears, leading to a significant saving in system administration effort.

### Saving in virtual storage

There is a saving in virtual storage within the CICS address space, as the definitions of autoinstalled resources do not occupy table space until they are generated.

## Faster startup times

### Warm and emergency starts

If you are using program autoinstall *with cataloging*, restart times are similar to those of restarting a CICS region that is not using program autoinstall. This is because, in both cases, resource definitions are reinstalled from the catalog during the restart. The definitions after the restart are those that existed before the system was terminated.

If you are using autoinstall *without cataloging*, CICS restart times are improved because CICS does **not** install definitions from the CICS global catalog. Instead, definitions are autoinstalled as required whenever programs, mapsets, and partitionsets are referenced following the restart.

See the *CICS Recovery and Restart Guide* for information on cataloging.

### Initial and cold starts

Startup times are faster than for a region that does not use program autoinstall, because program definitions are installed singly, as required, rather than all together at startup.

---

## Requirements for program autoinstall

To use autoinstall with programs, mapsets, and partitionsets, you must:

1. Write a customized version of the autoinstall control program for programs, DFHPGADX (unless the supplied version is entirely suitable for your purposes).
2. Specify the name of your control program on the **PGAIXIT** system initialization parameter (the default name is DFHPGADX), or on a SET SYSTEM PROGAUTOEXIT command.
3. Make program autoinstall active by specifying 'ACTIVE' on the **PGAIPGM** system initialization parameter (or by issuing a SET SYSTEM PROGAUTOINST(AUTOACTIVE) command).
4. Specify whether you want autoinstalled program definitions to be recorded on the CICS global catalog, on the **PGAICTLG** system initialization parameter (or on a SET SYSTEM PROGAUTOCTLG command).
5. Include the DFHPGAIP resource definition group in your CICS startup grouplist. DFHPGAIP (which is already included in the CICS-supplied startup list, DFHLIST) contains the default program, mapset, and partitionset model definitions passed to the autoinstall control program, and a definition of DFHPGADX (that you may need to amend).
6. Create any additional program, mapset, and partitionset model definitions that you need, and add this group to your startup grouplist.
7. If you want to log messages associated with program autoinstall, define the CSPL transient data (TD) queue.

For information about coding system initialization parameters, see the *CICS System Definition Guide*.

---

## The autoinstall control program at INSTALL

On invocation, CICS passes a parameter list to the autoinstall control program by means of a communication area addressed by DFHEICAP. The communications area is mapped by a copybook that is supplied in each of the languages supported by CICS.

The assembler form of the parameter list is as follows:

### **PGAC\_PROGRAM**

passes the 8-byte name of the object to be autoinstalled. This is an input-only field, which your user-replaceable program must not alter.

### **PGAC\_MODULE\_TYPE**

passes a 1-byte indicator of the type of object to be installed. The equated values are:

#### **PGAC\_TYPE\_PROGRAM**

A program

#### **PGAC\_TYPE\_MAPSET**

A mapset

#### **PGAC\_TYPE\_PARTITIONSET**

A partitionset.

This is an input-only field, which your user-replaceable program must not alter.

### **PGAC\_MODEL\_NAME**

allows your control program to specify the 8-byte autoinstall model name to be used. If you do not set this field, CICS uses the default model name for the type of object:

#### **DFHPGAPG**

For a program

#### **DFHPGAMP**

For a mapset

#### **DFHPGAPT**

For a partitionset.

### **PGAC\_LANGUAGE**

allows your control program to specify, in a 1-byte field, the language of the program to be autoinstalled. The equated values are:

#### **PGAC\_ASSEMBLER**

Assembler

#### **PGAC\_COBOL**

COBOL

#### **PGAC\_C370**

C

#### **PGAC\_LE370**

Language Environment

#### **PGAC\_PLI**

PL/I.

If you do not set this field, the autoinstall routine uses the language defined in the model, if one is specified. However, when control is passed to the program, CICS determines the language from the program itself, and overrides any specification provided.

You should not need to specify the language of executable programs that have been translated using the EXEC CICS translator before compiling.

**PGAC\_CEDF\_STATUS**

allows you to specify, in a 1-byte field, the execution diagnostic facility (EDF) status of the program to be autoinstalled. The equated values are:

**PGAC\_CEDF\_YES**

EDF can be used with this program.

**PGAC\_CEDF\_NO**

EDF cannot be used with this program.

**PGAC\_DATA\_LOCATION**

allows you to specify, in a 1-byte field, the data location for task-lifetime storage. The equated values are:

**PGAC\_LOCATION\_BELOW**

Task-lifetime storage must be located below 16MB.

**PGAC\_LOCATION\_ANY**

Task-lifetime storage can be below or above 16MB.

**PGAC\_EXECUTION\_KEY**

allows you to specify, in a 1-byte field, the execution key for the program. The equated values are:

**PGAC\_CICS\_KEY**

The program is to execute in CICS key.

**PGAC\_USER\_KEY**

The program is to execute in user key.

**PGAC\_LOAD\_ATTRIBUTE**

allows you to specify, in a 1-byte field, the load attributes for the object. The equated values are:

**PGAC\_RELOAD**

CICS is to load a fresh copy of the object for each request.

**PGAC\_RESIDENT**

CICS is to make the object permanently resident.

**PGAC\_TRANSIENT**

The storage for this object is to be released whenever the use count reaches zero.

**PGAC\_REUSABLE**

CICS can use any copy of the object currently in storage.

**PGAC\_USE\_LPA\_COPY**

allows you to specify, in a 1-byte field, whether CICS is to use an LPA-resident copy of the program. The equated values are:

**PGAC\_LPA\_YES**

CICS is to use a copy from the LPA.

**PGAC\_LPA\_NO**

CICS is to load a private copy from its own DFHRPL or dynamic LIBRARY concatenation.

**PGAC\_EXECUTION\_SET**

allows you to specify, in a 1-byte field, whether or not the program is restricted to using the distributed program link (DPL) subset of the CICS API. The equated values are:

**PGAC\_DPLSUBSET**

The program is to be restricted to the DPL subset of the EXEC CICS API.

**PGAC\_FULLAPI**

The program can use the full API.

**PGAC\_REMOTE\_SYSID**

allows you to specify, in a 4-byte field, the name of the remote system where the program is to execute. CICS function ships any request for this program to the specified remote CICS.

**PGAC\_REMOTE\_PROGID**

allows you to specify, in an 8-byte field, the name by which the program is known in the remote CICS region. For a remote program, the remote name defaults to the local name if you set this field to blank.

**PGAC\_REMOTE\_TRANSID**

allows you to specify, in a 4-byte field, the name of the CICS mirror transaction under which the program, if remote, is to run. By default, this is set to the name of the CICS mirror transaction, CSMI.

**PGAC\_DYNAMIC\_STATUS**

allows you to specify, in a 1-byte field, whether, if the program is the subject of a program-link request, the request can be dynamically routed. The equated values are:

**PGAC\_DYNAMIC\_NO**

If the program is the subject of a program-link request, the dynamic routing program is not invoked.

For a distributed program link (DPL) request, the server region on which the program is to execute must be specified explicitly on the REMOTESYSTEM option of the PROGRAM definition or on the SYSID option of the EXEC CICS LINK command; otherwise it defaults to the local region.

**PGAC\_DYNAMIC\_YES**

If the program is the subject of a program-link request, the dynamic routing program is invoked. Providing that a remote server region is not named explicitly on the SYSID option of the EXEC CICS LINK command, the routing program can route the request to the region on which the program is to execute.

**PGAC\_CONCURRENCY**

allows you to specify, in a 1-byte field, whether or not the program is written to threadsafe standards. The equated values are:

**PGAC\_QUASIRENT**

The program is quasi-reentrant only, and relies on the serialization provided by CICS when accessing shared resources.

The program is restricted to the CICS permitted programming interfaces, and must comply with the CICS quasi-reentrancy rules.

**PGAC\_THREADSAFE**

The program is written to threadsafe standards, and when it accesses

shared resources it takes into account the possibility that other programs may be executing concurrently and attempting to modify the same resources.

**PGAC\_JVM**

allows you to specify, in a 1-byte field, whether the program is to be run under a JVM. The equated values are:

**PGAC\_JVM\_YES**

The program is a Java bytecode program and must run under the control of a JVM.

**PGAC\_JVM\_NO**

The program does not require a JVM for its execution.

**PGAC\_JVM\_CLASS\_LEN**

allows you to specify, as a two-byte binary value, the length of the Java class name supplied in PGAC\_JVM\_CLASS\_DATA.

**PGAC\_JVM\_CLASS\_DATA**

allows you to specify, as a 256-byte field, the name of the Java class to be invoked.

**PGAC\_JVM\_PROFID**

allows you to specify, in an 8-byte field, the name of the JVM profile to be used for the JVM in which the program is to run.

**PGAC\_RETURN\_CODE**

allows you to specify, in a 1-byte field, the autoinstall control program's return code to CICS. The equated values are:

**PGAC\_RETURN\_OK**

Install the program definition using the values returned in the communications area parameter list.

**PGAC\_RETURN\_DONT\_DEFINE\_PROGRAM**

Do not define the program.

## The sample autoinstall control program for programs, DFHPGADX

The CICS-supplied default autoinstall program is an assembler-language command-level program, named DFHPGADX. The source of the default program is provided in COBOL, PL/I, and C, as well as in assembler language. The names of the supplied programs and their associated copy books, and the CICSTS32.CICS libraries in which they can be found, are summarized in Table 31.

*Table 31. Sample programs and copy books for program autoinstall*

Language	Member name	Library
Executable file: Assembler only	DFHPGADX	SDFHLOAD
Program source: Assembler COBOL PL/I C	DFHPGADX DFHPGAOX DFHPGALX DFHPGAHX	SDFHSAMP SDFHSAMP SDFHSAMP SDFHSAMP
Copy books: Assembler COBOL PL/I C	DFHPGACD DFHPGACO DFHPGACL DFHPGACH	SDFHMAC SDFHCOB SDFHPL1 SDFHC370

## Customizing the sample program

You can write your autoinstall control program in any of the languages supported by CICS, with full access to the CICS application and system programming interfaces.



If you customize the supplied control program, or write your own version, you should note the following:

- **Input:**The first two fields of the parameter list are input-only fields and should not be altered by your program.
- **Output:**The remaining fields on the parameter list are input/output or output only fields, which you can use to specify attributes that override those of the model definition.
- Some of the output fields in the parameter list are not applicable to mapsets or partitionsets. CICS ignores any parameters you specify that are not applicable to the type of object being installed.
- Any attributes you return to CICS in the parameter list are used to modify the model definition, and CICS installs the modified definition. Once installed, the definition can be modified normally using the EXEC CICS SET PROGRAM or CEMT SET PROGRAM commands.
- If you modify your control program, you can make the new version available by using the EXEC CICS SET PROGRAM NEWCOPY or CEMT SET PROGRAM NEWCOPY command.
- You can discard definitions after they have been installed; they are reinstalled when next referenced.
- You must ensure that the parameters you return to CICS are valid, and consistent with other system attributes in your CICS region. For example:
  - Do not return PGAC\_LPA\_YES on the PGAC\_USE\_LPA\_COPY parameter if CICS is running with the system initialization parameter LPA=NO.
  - Do not return PGAC\_USER\_KEY (which is the default) on the PGAC\_EXECUTION\_KEY parameter if the task for which your control program is called is running with CICS-key task-lifetime storage.You can determine the storage key for the task by testing the TASKDATAKEY option in its transaction definition by means of the following EXEC CICS commands:
  - EXEC CICS ADDRESS EIB
  - EXEC CICS INQUIRE TRANSACTION(eibtrans) TASKDATAKEY(...)

## Important

When creating an autoinstalled program definition, CICS ignores the program language specified on the model program definition. CICS determines the language from the load module itself, when the autoinstalled program is invoked.

However, CICS does *not* deduce characteristics other than language from the load module. These other program characteristics must be explicitly defined by the autoinstall control program or by RDO. If your programs have varying characteristics (varying AMODE or DATALOCATION requirements, for example), you must be able to distinguish between the various types when using autoinstall. You could do this by keeping a list of exceptions to the default characteristics, and coding your autoinstall control program to refer to this list; or you might decide to install explicit RDO definitions of the exceptions.

## Resource definition

The autoinstall control program cannot itself be autoinstalled, nor can any program it references. You must define a program resource definition in the CSD for the control program and for any other programs it references. You must also ensure these definitions are installed in the CICS region during startup by including the

group containing the definitions in your startup grouplist. If you specify an invalid name for the control program, CICS disables the program, thus disabling the program autoinstall function.

The following program resource definitions are supplied by CICS for the autoinstall control program; the default is the assembler version, DFHPGADX. If these definitions are not suitable for your use, you can create your own, using RDO or the DFHCSDUP utility.

- Default autoinstall control program definition for DFHPGADX. This defines the assembler version, and its status is set to ENABLED:

```
GROUP(DFHPGAIP)      PROGRAM(DFHPGADX)
DESCRIPTION(Assembler definition for program autoinstall exit)
LANGUAGE(ASSEMBLER) EXECKEY(CICS)      EXECUTIONSET(FULLAPI)
RELOAD(NO)           RESIDENT(NO)      USAGE(NORMAL)
STATUS(ENABLED)      CEDF(NO)           DATALOCATION(ANY)
```

- Autoinstall control program definition for DFHPGAOX. This defines the CICS-supplied COBOL version, and its status is set to DISABLED:

```
GROUP(DFHPGAIP)      PROGRAM(DFHPGAOX)
DESCRIPTION(COBOL definition for program autoinstall exit)
LANGUAGE(COBOL)      EXECKEY(CICS)      EXECUTIONSET(FULLAPI)
RELOAD(NO)           RESIDENT(NO)      USAGE(NORMAL)
STATUS(DISABLED)     CEDF(NO)           DATALOCATION(ANY)
```

- Autoinstall control program definition for DFHPGAHX. This defines the CICS-supplied C version, and its status is set to DISABLED:

```
GROUP(DFHPGAIP)      PROGRAM(DFHPGAHX)
DESCRIPTION(C definition for program autoinstall exit)
LANGUAGE(C)           EXECKEY(CICS)      EXECUTIONSET(FULLAPI)
RELOAD(NO)           RESIDENT(NO)      USAGE(NORMAL)
STATUS(DISABLED)     CEDF(NO)           DATALOCATION(ANY)
```

- Autoinstall control program definition for DFHPGALX. This defines the CICS-supplied PL/I version, and its status is set to DISABLED:

```
GROUP(DFHPGAIP)      PROGRAM(DFHPGALX)
DESCRIPTION(PL/I definition for program autoinstall exit)
LANGUAGE(PLI)         EXECKEY(CICS)      EXECUTIONSET(FULLAPI)
RELOAD(NO)           RESIDENT(NO)      USAGE(NORMAL)
STATUS(DISABLED)     CEDF(NO)           DATALOCATION(ANY)
```

## Testing and debugging your program

You can use the CICS execution diagnostic facility (EDF) to help you test your autoinstall control program. However, EDF is inhibited for programs with names that begin with the letters DFH; so to use EDF you must name your program something other than one of the default names.

---

## Chapter 17. Writing a dynamic routing program

### Considerations common to all user-replaceable programs

Note that the comments contained in Chapter 5, “General notes about user-replaceable programs,” on page 435 apply to this chapter.

This chapter describes the CICS default dynamic routing program and tells you how to write your own version. It assumes you are familiar with the principles of CICS transaction routing, CICS distributed program link (DPL), and Introduction to CICS dynamic routing described in the *CICS Intercommunication Guide*.

You can use the dynamic routing program to route:

- Transactions initiated from user terminals
- Transactions initiated by a subset of terminal-related EXEC CICS START commands
- Program-link requests
- Program-link requests to DFHL3270 to execute a CICS transaction using the bridge.

For detailed information about which transactions initiated by START commands, and which program-link requests, are eligible for dynamic routing, see Routing transactions invoked by START commands, in the *CICS Intercommunication Guide*.

#### Note:

1. You cannot use the *dynamic* routing program—that is, the program named on the DTRPGM system initialization parameter—to route:
  - CICS business transaction services activities and processes.
  - Method requests for enterprise beans or CORBA stateless objects.
  - Non-terminal-related EXEC CICS START requests.
  - Inbound Web services requests.

To route these types of request you must use the *distributed* routing program named on the DSRTPGM system initialization parameter. How to write a distributed routing program is described in Chapter 18, “Writing a distributed routing program,” on page 623.

2. The dynamic routing program and the distributed routing program may, of course, be the same program.

### Important

If you use the CICSplex System Manager (CICSplex SM) product to manage your CICSplex, you may not need to write a dynamic routing program. CICSplex SM provides a fully-functioning dynamic routing program that supports workload balancing and workload separation. All you have to do is to tell CICSplex SM, through its user interface, which regions in the CICSplex can participate in dynamic routing, and define any transaction affinities that govern the target regions to which particular transactions must be routed. For introductory information about CICSplex SM, see the *CICSplex SM Concepts and Planning* manual.

The rest of the chapter is divided into the following sections:

1. “Routing transactions dynamically” on page 590
2. “Routing DPL requests dynamically” on page 597

3. “Routing bridge requests dynamically” on page 603
4. “Routing by user ID” on page 607
5. “Parameters passed to the dynamic routing program” on page 607
6. “Naming your dynamic routing program” on page 621
7. “Testing your dynamic routing program” on page 621
8. “Dynamic transaction routing sample programs” on page 622.

---

## Routing transactions dynamically

This section refers to the dynamic routing of transactions initiated from user terminals or by eligible terminal-related EXEC CICS START commands.

When you define transactions to CICS, you can describe them as “remote” or “local”. Local transactions are always executed in the terminal-owning region; remote transactions can be routed to other regions connected to the terminal-owning region by MRO or APPC (LUTYPE6.2) ISC links.

You can select both the system to which the transaction is to be routed and the transaction’s remote name dynamically, rather than when the transaction is defined to CICS. To do this you must use a **dynamic routing program**. The CICS-supplied default routing program is called DFHDYP. Its source-level code is supplied in assembler-language, COBOL, PL/I, and C versions. You can write your own program in any of these languages, using the default program as a model.

## Dynamic transactions

When you want to route transactions dynamically, you must define them with the value DYNAMIC(YES). (The default value is DYNAMIC(NO).) You must also supply values for both the remote and the local options. This allows CICS to select the appropriate values when the transaction is routed, and to ignore those values that are not needed. For information about defining transactions for dynamic transaction routing, see Defining transactions for transaction routing, in the *CICS Intercommunication Guide*.

## When the dynamic routing program is invoked

For transactions initiated from user terminals or by eligible terminal-related EXEC CICS START commands, CICS invokes the dynamic routing program as follows:

- When a transaction defined as DYNAMIC(YES) is initiated.

**Note:**

1. If a transaction definition is not found, CICS uses the common transaction definition specified on the DTRTRAN system initialization parameter. (For information about DTRTRAN, see DTRTRAN, in the *CICS System Definition Guide*.)
  2. If a transaction defined as DYNAMIC(YES) and initiated by a terminal-related EXEC CICS START command is ineligible for dynamic routing, the routing program is invoked for notification only—it cannot route the transaction.
- If an error occurs in route selection—for example, if the target region returned by the routing program on its initial (route selection) call is unavailable. This gives the routing program an opportunity to specify an alternate target. This process iterates until the routing program selects a target that is available or sets a non-zero return code.

- After the routed transaction has completed, if the routing program has requested to be reinvoked at termination.
- If the routed transaction abends, if the routing program has requested to be reinvoked at termination.

Figure 57 shows the points at which the dynamic routing program is invoked.

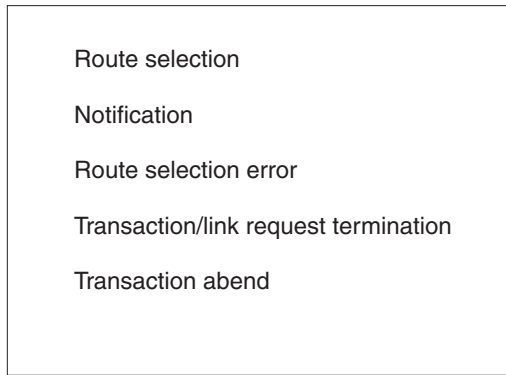

Figure 57. When the dynamic routing program is invoked

## Information passed to the dynamic routing program

The CICS relay program, DFHAPRT, passes information to the dynamic routing program by means of a communications area. The communications area contains fields that are mapped by the DSECT DFHDYPDS, and is described in detail in “Parameters passed to the dynamic routing program” on page 607. For transaction routing, some of the data passed to the dynamic routing program in the communications area are:

- The SYSID of the remote CICS region specified when the transaction was installed
- The netname of the remote CICS region
- The name of the remote transaction
- The dispatch priority (MRO only) of the remote transaction
- Whether or not the request is to be queued if no sessions are immediately available to the remote CICS region
- The address of the remote transaction’s communications area
- The address of a copy of the transaction’s terminal input/output area (TIOA)
- A task-local user data area.

The communications area DSECT contains comments to describe the information passed.

The dynamic routing program can accept these values, or change them, or tell CICS not to continue routing the transaction. The values used depend on the function being performed; that is, some values may be ignored.

The information passed to the dynamic routing program indicates whether the transaction is being routed dynamically or statically. If the transaction is being routed dynamically, the dynamic routing program can change the SYSID or netname to determine where the transaction is to run.

Sometimes, the dynamic routing program may be invoked for transactions that are routed statically. This happens if a transaction defined as DYNAMIC(YES) is initiated by automatic transaction initiation (ATI)—for example, by the expiry of an interval control start request—but the transaction is ineligible for dynamic routing. In this case, the dynamic routing program is called only to notify it of where the transaction is going to run. It cannot change the remote system name, and any changes it makes to the SYSID or NETNAME fields in the communications area are ignored.

For transactions that are run remotely, either because they are defined as remote or because they are dynamically routed to a remote CICS region, CICS monitoring is informed of the SYSID of the remote CICS region. For transactions that the dynamic routing program routes locally, the monitoring field is set to nulls.

## Changing the target CICS region

The communications area passed to the dynamic routing program initially contains the system identifier (sysid) and netname of the default CICS region to which the transaction is to be routed. These are derived from the value of the REMOTESYSTEM option of the installed transaction definition. If the transaction definition does not specify a REMOTESYSTEM value, the sysid and netname passed are those of the local CICS region.

The dynamic routing program can change the sysid and netname. If it does so when it is invoked for route selection, the region to which the transaction is routed is determined as follows:

- The NETNAME and the SYSID are not changed.  
CICS tries to route to the SYSID as originally specified in the communications area.
- The NETNAME is not changed, but the SYSID is changed.  
CICS updates the communications area with the NETNAME corresponding to the new SYSID, and tries to route to the new SYSID.
- The NETNAME is changed, but the SYSID is not changed.  
CICS updates the communications area with a SYSID corresponding to the new NETNAME, and tries to route to the new SYSID.
- The NETNAME is changed **and** the SYSID is changed.  
CICS overwrites the communications area with a SYSID corresponding to the new NETNAME, and tries to route to that new SYSID.

If the NETNAME specified is invalid, or cannot be found, SYSIDERR is returned to the dynamic routing program—which may deal with the error by returning a different SYSID or NETNAME—see “If the system is unavailable or unknown” on page 594.

If the routing program changes the SYSID or NETNAME when it is invoked for notification, the changes have no effect.

### Using a common transaction definition in the TOR

The recommended method is to use a single, common definition for all remote transactions that are to be dynamically routed. The name of the common definition is specified on the DTRTRAN system initialization parameter. You can use the REMOTESYSTEM option of the common definition to specify a default AOR to which transactions are to be routed. For information about defining remote transactions for dynamic transaction routing, see Defining remote resources, in the *CICS Intercommunication Guide*.

## Important

To route a transaction defined by the DTRTRAN definition, your dynamic routing program must set the DYRDTRRJ field of the communications area to 'N' (the default is 'Y'). If you leave DYTDTRRJ set to 'Y', the transaction is rejected.

You can test the DYRDTRXN field to check if the transaction passed to your routing program is defined by the DTRTRAN definition. Figure 58 contains skeleton code for routing transactions defined by DTRTRAN.

```
if DYRDTRXN='Y' then          /* Is DYP invoked because of DTRTRAN */
do                            /* .. Yes */
  Call Find_AOR(sysid)       /* Select the SYSID of the AOR */
  if rc=0 then              /* Is AOR available? */
  do                          /* .. Yes */
    DYRRET=RETCOD0          /* Set OK Return Code */
    DYRSYSID=sysid         /* Set the sysid */
    DYRDTRRJ='N'           /* Don't reject DTRTRAN defns */
    ...                     /* Set other commarea fields */
  end                          /* */
else                          /* .. No */
  ...                        /* AOR unavailable logic */
end                            /* */
```

Figure 58. Example pseudocode to route transactions defined by DTRTRAN

## Changing the program name

For transactions defined as DYNAMIC, on invocation of the routing program the DYRLPROG field in the communications area contains the name of the initial program associated with the transaction to be routed. If you decide to route the transaction locally, you can use this field to specify an alternative program to be run. For example, if all remote CICS regions are unavailable and the transaction cannot be routed, you may want to run a program in the local CICS terminal-owning region to send an appropriate message to the user.

## Telling CICS whether to route or terminate a transaction

When the routing program is invoked for routing, it can choose whether the transaction should be routed or terminated. If you want the transaction to be routed, whether you have changed any values or not, return a zero value to CICS in field DYRRET of the communications area. When you return control to CICS with return code zero, CICS first compares the returned SYSID with its own local SYSID:

- If the SYSIDs are the same (or the returned SYSID is blank) CICS executes the transaction locally.
- If the two SYSIDs are not the same, CICS routes the transaction to the remote CICS region, using the remote transaction name.

If you want to terminate the transaction with a message or an abend, set a return code of X'8' (or any other non-zero return code other than X'4').

If you want to terminate the transaction without issuing a message or abend, set a return code of X'4'.

**Warning:** Setting a return code of X'4' for APPC transaction routing leads to unpredictable results, and should be avoided.

Returning a value in DYRRET has no effect when the routing program is invoked for notification or at termination of the transaction.

## If the system is unavailable or unknown

The dynamic routing program is invoked again if the remote system name that you specify on the route selection call is not known or is unavailable. When this happens, you have a choice of actions:

- You can tell CICS not to continue trying to route the transaction, by issuing a return code of '8' in DYRRETC. If the reason for the error is that the system is unavailable, CICS issues message 'DFHAC2014' or 'DFHAC2029' to the terminal user. If the reason for the error is that the system is unknown, DFHAPRT abends the transaction.
- You can tell CICS to terminate the transaction without issuing a message or abend by placing a return code of '4' in DYRRETC. However, note the above warning about setting return code '4'.
- If the reason for the error is that no sessions are immediately available to the remote system, you can reset field DYRQUEUE to 'Y' (it must previously have been set to 'N'—the request is **not** to be queued—for this error to occur), issue a return code of '0' in DYRRETC, and try to route the transaction again.

If you try to route the transaction again **without** resetting DYRQUEUE to 'Y' (and without changing the sysid), and the system is still unavailable, DFHDYP is reinvoked. If you then choose to set return code '8', CICS terminates the transaction with message 'DFHAC2030'.

- You can change the sysid, and issue a return code of '0' in DYRRETC to try to route the transaction again. Note that if you change the sysid, you may also need to supply a different remote transaction ID. You need to do this if, for example, the transaction has a different remote transaction name on each system.

A count of the times the routing program has been invoked for routing purposes for this transaction is passed in field DYRCOUNT. Use this count to help you decide when to stop trying to route the transaction.

## Invoking the dynamic routing program at end of routed transactions

If you want your dynamic routing program to be invoked again when the routed transaction has completed, you must set the DYROPTER field in the communications area to 'Y' before returning control to CICS. You might want to do this, for example, if you are keeping a count of the number of transactions currently executing on a particular CICS region. However, during this reinvocation, the dynamic routing program should update only its own resources. This is because, at this stage, the final command to the terminal from the application program in the AOR may be pending, and the dynamic routing program is about to terminate.

## Invoking the dynamic routing program on abend

If you have set DYROPTER to 'Y', and the routed transaction abends, the dynamic routing program is invoked again to notify it of the abend. You could use this invocation to initiate a user-defined program in response to the transaction abend.

If the routed transaction abends, the DFHAPRT program in the TOR:

1. Passes back a response to the CICS transaction manager indicating that a transaction abend has occurred
2. If the dynamic routing program requested to be reinvoked at termination of the transaction (by setting DYROPTER to 'Y' when invoked for routing), reinvokes the dynamic routing program
3. Returns to CICS transaction manager.



## Modifying the initial terminal data

The dynamic routing program should **not** perform an EXEC CICS RECEIVE or an EXEC CICS GDS RECEIVE command, because this prevents the routed-to transaction from obtaining the initial terminal data.

The CICS relay program, DFHAPRT, places a *copy* of the user's initial terminal input into a separate buffer. This information includes SNA presentation services headers for APPC mapped and unmapped conversations. A pointer to this buffer (DYRBPNTNTR), and its length (DYRBLGTH), are provided in the communications area passed from DFHAPRT to the dynamic routing program.

Note that:

- The buffer pointed to by DYRBPNTNTR contains the data that arrived in the first request unit (RU) of the message. If the RU size is large enough to hold the full message, the buffer contains the full message. However, if the RU size is less than the message length, the buffer contains only the data from the first RU (even if the buffer itself is large enough to hold the full message).
- The length field DYRBLGTH is the length of the *message*, not the length of the data in the buffer. DYRBLGTH contains the length of data in the buffer only if the full message arrived in a single RU.
- If all the following are true, no initial terminal input data is passed to the routing program:
  1. The routing program is running in the AOR.
  2. The original request was transaction-routed from the TOR.
  3. The originating facility is an APPC parallel session.

Because the transaction profile has not been queried at this point, uppercase translation has not been performed on the input data unless UCTRAN(YES) is specified on the TYPETERM definition.

Sometimes you may want to modify the initial data input by the user. (It may be necessary to do this if, for example, you change the ID of the remote transaction, using field DYRTRAN of the communications area.) To modify the input data, your routing program should, when invoked for route selection:

1. Copy the input data pointed to by DYRBPNTNTR into a named variable, of length DYRBLGTH
2. Modify the data in the named variable
3. Use the INPUTMSG option of the EXEC CICS RETURN command to make the modified data available to the application program.

For guidance information about using INPUTMSG on EXEC CICS RETURN commands, see the other methods described in INPUTMSG, in the *CICS Application Programming Guide*. For programming information about the INPUTMSG option, see RETURN, in the *CICS Application Programming Reference manual*.

**Note:** If, after modifying the input data, the dynamic routing program is reinvoked because an error occurs in routing to the selected transaction, it should “remember” that it has modified the original user-input.

## Modifying the application's communications area

Sometimes you may want to modify the routed application's communications area. For example, if your routing program changes the ID of the remote transaction, it

may also need to change the input communications area passed to the routed application. Field DYRACMAA of the routing program's communications area enables you to do this; it is a pointer to the application's communications area.

See also "Modifying the application's containers" on page 607.

## Receiving information from a routed transaction

If your dynamic routing program chooses to be reinvoked at the end of a routed transaction, it can obtain information about the transaction by monitoring its output communications area and output TIOA.

### Monitoring the output communications area

A routed transaction can pass information back to the dynamic transaction routing program in its output communications area. When invoked at transaction termination, your routing program can examine the output communications area (pointed to by DYRACMAA). The following is an example of how this facility could be used:

- You have a CICSplex consisting of sets of functionally-equivalent TORs and AORs, and need to identify any inter-transaction affinities that may affect transaction routing. You could use the IBM CICS Interdependency Analyzer for z/OS<sup>4</sup> to do this, but there are some affinities that the utility cannot detect (for example, those created by non-CICS functions). Also, some transactions may sometimes create affinities, and sometimes not.

However, the routed transactions themselves "know" when an affinity is created, and can communicate this to the dynamic transaction routing program. The routing program is then able to route such transactions accordingly.

See also "Modifying the application's containers" on page 607.

### Monitoring the output TIOA

When invoked at transaction termination, your routing program can examine the copy of the routed transaction's output TIOA pointed to by DYRBPNTR. This can be useful, for example, to guard against the situation where one AOR in a CICSplex develops software problems. These may be reported by means of a message to the end user, rather than by a transaction abend. If this happens, the routing program is unaware of the failure and cannot bypass the AOR that has the problem. By reading the output TIOA, your routing program can check for messages indicating specific kinds of failure, and bypass any AOR that is affected.

## Some processing considerations

- Any of the EXEC CICS commands (except EXEC CICS RECEIVE—see "Modifying the initial terminal data" on page 595) can be issued from the routing program. You are likely to find the EXEC CICS INQUIRE CONNECTION and INQUIRE IRC commands particularly useful if you want to confirm that a link is available before routing a transaction. The EXEC CICS INQUIRE and SET commands are described in the *CICS System Programming Reference* manual.
- Although the routing program can issue any EXEC CICS command, you should consider carefully the effect of commands that alter protected resources, because changes to those resources may be committed or backed out inadvertently as a

---

4. For information about the IBM CICS Interdependency Analyzer for z/OS, see the *CICS Interdependency Analyzer for z/OS User's Guide and Reference*.

result of logic in the routed transaction. You should also consider carefully the effect of EXEC CICS SYNCPOINT and ABEND commands on APPC transaction routing.

- If you want to keep information about how transactions are routed, it must be done in the user routing program, perhaps by writing the information to a temporary storage queue associated with this terminal.
- Several transactions can form a single conversation with the end user. At the start of the conversation, resources are allocated to record the state of the conversation. Because these resources are local to the system to which the first transaction in the conversation was routed, the routing program must be able to continue to route to this system until the end of the conversation.
- It is important to avoid creating “tangled daisychains”: for any transaction that is being dynamically routed, you must avoid routing back to a node that has previously been routed from.
- The dynamic routing program can be RMODE ANY but must be AMODE 31.

## Unit of work considerations

Depending on the terminal type, the CICS relay program, the dynamic routing program, and the routed transaction may constitute a single unit of work. Any protected resources owned by the dynamic routing program could therefore be affected by the syncpoint activity of the routed transaction. This means that these resources may be committed or backed out inadvertently by the routed transaction. If you want to avoid this, you have to define the routing program's resources as unprotected rather than protected.

---

## Routing DPL requests dynamically

For a program-link request to be eligible for dynamic routing, the remote program must either:

- Be defined to the local system as DYNAMIC(YES) *or*
- Not be defined to the local system.

**Note:** If the program specified on an EXEC CICS LINK command without a SYSID is not currently defined, what happens next depends on whether program autoinstall is active:

- If program autoinstall is inactive, the dynamic routing program is invoked.
- If program autoinstall is active, the autoinstall user program is invoked. The dynamic routing program is then invoked only if the autoinstall user program:
  - Installs a program definition that specifies DYNAMIC(YES), or
  - Does not install a program definition.

See “Autoinstalling programs invoked by EXEC CICS LINK commands” on page 580.

As well as “traditional” CICS-to-CICS DPL calls instigated by EXEC CICS LINK PROGRAM commands, program-link requests received from outside CICS can also be dynamically routed. For example, all the following types of program-link request can be dynamically routed:

- Calls from external CICS interface (EXCI) client programs
- External Call Interface (ECI) calls from any of the CICS Client workstation products

- Distributed Computing Environment (DCE) remote procedure calls (RPCs)
- ONC/RPC calls.

A program-link request received from outside CICS can be dynamically routed by:

- Defining the program to CICS Transaction Server for z/OS as DYNAMIC(YES)
- Coding your dynamic routing program to route the request.

## When the dynamic routing program is invoked

For eligible program-link requests, CICS invokes the dynamic routing program as follows:

- Before the linked-to program is executed, to either:
  - Obtain the SYSID of the region to which the link should be routed.
 

**Note:** The address of the caller's communications area (COMMAREA) is passed to the routing program, which can therefore route requests by COMMAREA contents if this is appropriate.
  - Notify the routing program of a statically-routed request. This occurs if the program is defined as DYNAMIC(YES)—or is not defined—but the caller specifies the name of a remote region on the SYSID option of the LINK command.
 

In this case, specifying the target region explicitly takes precedence over any SYSID returned by the dynamic routing program.
- If an error occurs in route selection—for example, if the SYSID returned by the dynamic routing program is unavailable or unknown, or the link fails on the specified target region—to provide an alternate SYSID. This process iterates until either the program-link is successful or the return code from the dynamic routing program is not equal to zero.

### Special case: care!

If all the following are true, the route selection call fails *but the routing program is not reinvoked for a route selection error*:

1. The program is not defined on the local region.
2. Program autoinstall is not active on the local region.
3. On the route selection call, the routing program routes the link request to the local region.

Therefore, to dynamically route a program-link request *that the routing program may route locally*, you should do either of the following:

1. Install a program definition on the local region, specifying DYNAMIC(YES).
  2. Set program autoinstall active, using it to install a definition that specifies DYNAMIC(YES).
- After the link request has completed, if reinvocation was requested by the routing program.
  - If an abend is detected after the link request has been shipped to the specified remote system, if reinvocation was requested by the routing program.

Figure 57 on page 591 shows the points at which the dynamic routing program is invoked.

## Changing the target CICS region

The communications area passed to the dynamic routing program initially contains the system identifier (sysid) and netname of the default CICS region to which the link request is to be routed. These are derived from the value of the REMOTESYSTEM option of the installed program definition. If REMOTESYSTEM is not specified, or there is no program definition, the sysid and netname passed are those of the local CICS region.

The dynamic routing program can change the sysid and netname.<sup>5</sup> If it does so when it is invoked for route selection, the region to which the link request is routed is determined as follows:

- The NETNAME and the SYSID are not changed.  
CICS tries to route to the SYSID as originally specified in the communications area.
- The NETNAME is not changed, but the SYSID is changed.  
CICS updates the communications area with the NETNAME corresponding to the new SYSID, and tries to route the request to the new SYSID.
- The NETNAME is changed, but the SYSID is not changed.  
CICS updates the communications area with a SYSID corresponding to the new NETNAME, and tries to route the request to the new SYSID.
- The NETNAME is changed **and** the SYSID is changed.  
CICS overwrites the communications area with a SYSID corresponding to the new NETNAME, and tries to route the request to that new SYSID.

You can route DPL requests over both IPIC and ISC over SNA connections. If there is both an IPIC connection and an ISC over SNA connection to the selected target region, and both are named the same, the IPIC connection takes precedence. That is, if remote SYSID “CICB” is defined by both an IPCONN definition and a CONNECTION definition, CICS uses the IPCONN connection.

If the NETNAME specified is invalid, or cannot be found, SYSIDERR is returned to the dynamic routing program—which may deal with the error by returning a different SYSID or NETNAME—see “If an error occurs in route selection” on page 600.

If the routing program changes the SYSID or NETNAME when it is invoked for notification, the changes have no effect.

## Changing the program name

When the routing program is invoked for route selection or for notification of a program-link request, the DYRLPROG field in the communications area contains the name of the program to be linked, obtained using the following sequence:

1. From the REMOTENAME option of the installed program definition
2. If REMOTENAME is not specified, or there is no program definition, from the PROGRAM option of the EXEC CICS LINK command.

When it is invoked for routing<sup>6</sup> (not for notification of a statically-routed request), your routing program can, by overwriting the DYRLPROG field, specify that an

---

5. If the REMOTESYSTEM option of the program definition names a remote region, the routing program cannot route the request locally.

6. By “invoked for routing” we mean both “invoked for route selection” and “invoked because an error occurred in route selection”.

alternative program is to be linked. You can specify a local or remote program, depending on the region to which the request is to be routed.

## Changing the transaction ID

A transaction identifier is always associated with each dynamic program-link request. CICS obtains the transaction ID using the following sequence:

1. From the TRANSID option on the LINK command
2. From the TRANSID option on the program definition
3. 'CSMI', the generic mirror transaction. This is the default if neither of the TRANSID options are specified.

When it is invoked for routing (not for notification of a statically-routed request), your routing program can change the remote transaction ID by overwriting the DYRTRAN field in the communications area.

**Note:** If you use CICSplex System Manager to route your program-link requests, the transaction ID becomes highly significant, because CICSplex System Manager's routing logic is transaction-based. CICSplex System Manager routes each DPL request according to the rules specified for its associated transaction.

The CICSplex System Manager system programmer can use the EYU9WRAM user-replaceable module to change the transaction ID associated with a DPL request.

## Telling CICS whether to route or terminate a DPL request

When the routing program is invoked for routing, it can choose whether the link request should be routed or rejected. If you want the request to be routed, whether you have changed any values or not, return a zero value to CICS in field DYRRETC of the communications area. When you return control to CICS with return code zero, CICS first compares the returned SYSID with its own local SYSID:

- If the SYSIDs are the same (or the returned SYSID is blank) CICS executes the link request locally.
- If the two SYSIDs are not the same, CICS routes the request to the remote CICS region, using the returned program and transaction names.

To make CICS reject the link request, return a non-zero value. The program that issued the EXEC CICS LINK command receives a PGMIDERR condition, with a RESP2 value of 25.

Returning a value in DYRRETC has no effect when the routing program is invoked for notification or at termination of the request.

## If an error occurs in route selection

If an error occurs in route selection—for example, if the SYSID returned by the dynamic routing program is unavailable or unknown, or the link fails on the specified target region—the dynamic routing program is invoked again. When this happens, you have a choice of actions:

- You can tell CICS not to continue trying to route the request, by issuing a non-zero return code in DYRRETC.
- If the reason for the error is that no sessions are immediately available to the remote system, you can reset field DYRQUEUE to 'Y' (it must previously have

been set to 'N'—the request is **not** to be queued—for this error to occur), issue a return code of '0' in DYRRETC, and try to route the request again.

- You can change the sysid, and issue a return code of '0' in DYRRETC to try to route the request again. Note that if you change the sysid, you may also need to supply a different remote program name or transaction ID.

A count of the times the routing program has been invoked for routing purposes for this request is passed in field DYRCOUNT. Use this count to help you decide when to stop trying to route the transaction.

### Special case—care!

If all the following are true, the route selection call fails *but the routing program is not reinvoked for a route selection error*:

1. The program is not defined on the local region.
2. Program autoinstall is not active on the local region.
3. On the route selection call, the routing program routes the link request to the local region.

Therefore, to dynamically route a program-link request *that the routing program may route locally*, you should do either of the following:

1. Install a program definition on the local system, specifying DYNAMIC(YES).
2. Set program autoinstall active, using it to install a definition that specifies DYNAMIC(YES).

## Using the XPCERES exit to check the availability of resources on the target region

You can use an XPCERES global user exit program to check that all resources required by the linked-to program are available on the target region.

To use the XPCERES exit, both the routing region and the target region must support the “resource unavailable” condition (RESUNAVAIL). All the following support the “resource unavailable” condition:

- CICS TS OS/390, Version 1.3, with APAR PQ73107 applied
- CICS TS for z/OS, Version 2.2, with APAR PQ74920 applied
- CICS TS for z/OS, Version 2.3 and later

The XPCERES exit is invoked, if enabled, on the target region before CICS processes a dynamically-routed program-link request.

If, for example, the linked-to program is disabled on the target region, or a required file is missing, your exit program can give the dynamic routing program the opportunity to route the request to a different region. To do this, it should set a return code of UERCRESU. This causes CICS to:

1. Return a RESUNAVAIL condition on the EXEC CICS LINK command executed by the mirror on the target region. (This condition is *not* returned to the application program.)
2. Set the DYRERROR field of the routing program’s communications area to 'F'—resource unavailable.
3. Reinvoke the routing program, on the routing region, for route selection failure—see “If an error occurs in route selection” on page 600.

For information about writing an XPCERES global user exit program, see The XPCERES global user exit.

If a required resource is unavailable on the target region, but the XPCERES exit is unavailable or disabled (or is enabled but does not set the UERCRESU return code), the client program receives an error response.

## Invoking the dynamic routing program at end of routed requests

If you want your dynamic routing program to be invoked again when the routed request has completed, you must set the DYROPTER field in the communications area to 'Y' before returning control to CICS. You might want to do this, for example, if you are keeping a count of the number of link requests currently executing on a particular CICS region.

If you have set DYROPTER to 'Y', and the linked program abends, the dynamic routing program is invoked to notify it of the abend.

## Modifying the application's input communications area

Sometimes you may want to modify the routed application's communications area. For example, if your routing program changes the name of the remote program, it may also need to change the input communications area passed to the program. Field DYRACMAA of the routing program's communications area enables you to do this; it is a pointer to the application's communications area (or null, if no communications area was specified on the LINK command).

See also "Modifying the application's containers" on page 607.

## Monitoring the application's output communications area

A routed application can pass information back to the dynamic transaction routing program in its output communications area. If your dynamic routing program chooses to be reinvoked at the end of a routed DPL request, it can examine the output communications area (if any) pointed to by DYRACMAA.

See also "Modifying the application's containers" on page 607.

## Some processing considerations

- When invoked for program-link requests, the dynamic routing program should restrict its use of EXEC CICS commands to those in the DPL subset. For information about which commands constitute the DPL subset, see API restrictions for distributed program link, in the *CICS Application Programming Reference* manual.
- Although the routing program can issue any EXEC CICS command in the DPL subset, you should consider carefully the effect of commands that alter protected resources, because changes to those resources may be committed or backed out inadvertently as a result of logic in the routed program.
- If you want to keep information about how link requests are routed, it must be done in the user routing program, perhaps by writing the information to a temporary storage queue.
- It is important to avoid creating "tangled daisychains": for any program-link request that is being dynamically routed, you should avoid routing back to a node that has previously been routed from. For definitive information about the "daisy-chaining" of DPL requests, see "Daisy-chaining" of DPL requests, in the *CICS Intercommunication Guide*.



- The dynamic routing program can be RMODE ANY but must be AMODE 31.

## Unit of work considerations

The client program, the dynamic routing program, and possibly the server program constitute a single unit of work. Any recoverable resources owned by the dynamic routing program could therefore be affected by the syncpoint activity of the client program. This means that these resources may be committed or backed out inadvertently by the client program. If you want to avoid this, you have to define the routing program's resources as non-recoverable.

For information about the syncpoint activity of DPL client and server programs, see The server program, in the *CICS Intercommunication Guide*.

---

## Routing bridge requests dynamically

To run a 3270 **user transaction** under the control of the bridge, a client program must first issue a LINK, ECI or EXCI call to DFHL3270 running in the bridge **router** region, passing a COMMAREA that contains the bridge inbound message header (BRIH). The BRIH contains the name of the target user transaction. DFHL3270 (the bridge program) then links to the CICS driver program, passing the COMMAREA. If the user transaction is eligible for dynamic routing, DFHL3270 calls the dynamic routing program to determine the target system where the driver program will execute.

The user transaction always executes in the same region as the driver program. The client request to run the user transaction is dynamically routed, not the user transaction.

The resource definition of the target transaction on the router region is used to determine if the bridge request to the driver program is eligible for dynamic routing. If the target user transaction is not defined in the router region, the common transaction definition specified on the DTRTRAN system initialization parameter is used to determine if the request is eligible for dynamic routing.

In session mode, the target system of the first user transaction request determines where all subsequent user transaction requests in the session are routed. Remote requests can be routed to other regions connected to the router region by MRO links, or to other systems that are connected by APPC (LUTYPE6.2) ISC links.

**Note:** The local system is the CICS router region where the dynamic routing program is executing.

The dynamic routing program is invoked in the following cases:

- In single transaction mode when the transaction is defined as DYNAMIC(YES), or the transaction is not defined and the DTRTRAN transaction is defined as DYNAMIC(YES).
- In session mode when the first user transaction is defined as DYNAMIC(YES), or the transaction is not defined and the DTRTRAN transaction is defined as DYNAMIC(YES).
- In session mode when subsequent user transactions are defined as DYNAMIC(YES), or the transaction is not defined and the DTRTRAN transaction is defined as DYNAMIC(YES). In this case, the target system has already been determined by the first user transaction of the session, so the routing program is only invoked for notification; it cannot change the target system of the request.

- If an error occurs in route selection, for example, if the target region returned by the routing program on its initial (route selection) call is unavailable. This allows the routing program to specify an alternate target. This process iterates until the routing program selects a target that is available, or sets a non-zero return code.
- After the user transaction has completed, if the routing program has requested to be reinvoked at termination.

## Changing bridge request parameters

The communications area passed to the dynamic routing program initially contains parameters and pointers that you can examine. These are all described in “Parameters passed to the dynamic routing program” on page 607. The only parameters that you can change for a Link3270 bridge request are:

- The system identifier (SYSID) and netname of the CICS region to which the request is to be routed
- The transaction identifier (TRANSID) of the target user application that is to be run under control of the Link3270 bridge
- The dispatcher priority of the user transaction in the AOR
- A task-local user data area
- DTRTRAN indicators
- Termination option

### Changing the Link3270 bridge request SYSID

The initial values of the SYSID and netname of the default CICS region to which the request is to be routed are derived from the value of the REMOTESYSTEM option of the installed user program definition. If REMOTESYSTEM is not specified, or there is no program definition, the sysid and netname passed are those of the local CICS region.

The region to which the request is routed is determined as follows:

- The NETNAME and the SYSID are not changed.  
CICS tries to route to the SYSID as originally specified in the communications area.
- The NETNAME is not changed, but the SYSID is changed.  
CICS updates the communications area with the NETNAME corresponding to the new SYSID, and tries to route the request to the new SYSID.
- The NETNAME is changed, but the SYSID is not changed.  
CICS updates the communications area with a SYSID corresponding to the new NETNAME, and tries to route the request to the new SYSID.
- The NETNAME is changed **and** the SYSID is changed.  
CICS overwrites the communications area with a SYSID corresponding to the new NETNAME, and tries to route the request to that new SYSID.

If the NETNAME specified is invalid, or cannot be found, SYSIDERR is returned to the dynamic routing program—which may deal with the error by returning a different SYSID or NETNAME—see “Handling route selection errors of Link3270 bridge requests” on page 605.

When you return control to CICS with return code zero, CICS first compares the returned SYSID with its own local SYSID:

- If the SYSIDs are the same (or the returned SYSID is blank) CICS executes the link request locally.
- If the two SYSIDs are not the same, CICS routes the request to the remote CICS region, using the returned transaction name.

### **Changing the bridge request TRANSID**

The TRANSID of the target user transaction is passed to the dynamic routing program in Dyrtran. You can change this by overwriting the Dyrtran field in the communications area.

### **Changing the Link3270 bridge request transaction priority**

You can change the dispatching priority of the user transaction by specifying the priority in Dyrprty and putting “Y” in Dyr RTPRI. This priority will override the priority specified in the TRANSACTION resource definition in the AOR.

## **Rejecting a Link3270 bridge request**

When the routing program is invoked for routing, it can choose whether the link request should be routed or rejected. If you want the request to be routed, whether you have changed any values or not, return a zero value to CICS in field Dyrretc of the communications area.

The routing program can reject the request by returning a value of 4 or 8 in field Dyrretc.

The BRIH returned to the client contains a return code value indicating that the routing program has rejected the request. The BRIH compcode gives further information about the last attempt to route the request by the routing program. If the routing program placed a return code value of 8 into field Dyrretc a message is issued with the details of the last attempt to route the request.

Returning a value in Dyrretc has no effect when the routing program is invoked at request termination or when a notify call is being made.

## **Handling route selection errors of Link3270 bridge requests**

If an error occurs in route selection—for example, if the SYSID returned by the dynamic routing program is unavailable or unknown, or the link fails on the specified target region—the dynamic routing program is invoked again. When this happens, you have a choice of actions:

- You can tell CICS not to continue trying to route the request, by issuing a non-zero return code in Dyrretc.
- You can change the sysid, and issue a return code of ‘0’ in Dyrretc to try to route the request again. Note that if you change the sysid, you may also need to supply a different transaction ID.

A count of the times the routing program has been invoked for routing purposes for this request is passed in field Dyr count. Use this count to help you decide when to stop trying to route the transaction.

## **Using the XPCERES exit to check the availability of resources on the target region**

You can use an XPCERES global user exit program to check that all resources required by the 3270 user transaction are available on the target region.

To use the XPCERES exit, both the routing region and the target region must support the “resource unavailable” condition (RESUNAVAIL). All the following support the “resource unavailable” condition:

- CICS TS OS/390, Version 1.3, with APAR PQ73107 applied
- CICS TS for z/OS, Version 2.2, with APAR PQ74920 applied
- CICS TS for z/OS, Version 2.3 and later

The exit is invoked, if enabled, on the target region before CICS processes a dynamically-routed Link3270 bridge request.

If, for example, the 3270 user transaction is disabled on the target region, or a required file is missing, your exit program can give the dynamic routing program the opportunity to route the request to a different region. To do this, it should set a return code of UERCRESU. This causes CICS to:

1. Return a RESUNAVAIL condition on the EXEC CICS LINK call to DFHL3270 executed by the mirror on the target region
2. Set the DYRERROR field of the routing program's communications area to 'F'—resource unavailable
3. Reinvoke the routing program, on the routing region, for route selection failure—see “Handling route selection errors of Link3270 bridge requests” on page 605

For information about writing an XPCERES global user exit program, see The XPCERES global user exit.

If a required resource is unavailable on the target region, but the XPCERES exit is unavailable or disabled (or is enabled but does not set the UERCRESU return code), the client program receives an error response.

## Re-invoking the dynamic routing program after Link3270 bridge requests

If you want your dynamic routing program to be invoked again when the routed request has completed, you must set the DYROPTER field in the communications area to 'Y' before returning control to CICS. You might want to do this, for example, if you are keeping a count of the number of link requests currently executing on a particular CICS region.

If you have set DYROPTER to 'Y', and the linked program abends, the dynamic routing program is invoked to notify it of the abend.

## Link3270 bridge dynamic routing considerations

If you are using the DTRTRAN definition to route the Link3270 request, the routing program must set the DYRTTRRJ field of the communication area to 'N' (the default is 'Y'). If you leave DTRDTRRJ set to 'Y', the request will be rejected. You can test the DYRDTRXN field to check whether the transaction passed to your routing program is defined by the DTRTRAN definition.

- When invoked for Link3270 bridge requests, the dynamic routing program should restrict its use of EXEC CICS commands to those in the DPL subset. For information about which commands constitute the DPL subset, see API restrictions for distributed program link, in the *CICS Application Programming Reference* manual.
- Although the routing program can issue any EXEC CICS command in the DPL subset, you should consider carefully the effect of commands that alter protected

resources, because changes to those resources may be committed or backed out inadvertently as a result of logic in the routed program.

- If you want to keep information about how link requests are routed, it must be done in the user routing program, perhaps by writing the information to a temporary storage queue.
- The dynamic routing program can be RMODE ANY but must be AMODE 31.

---

## Modifying the application's containers

This section applies to the routing of:

- Transactions started by terminal-related START requests (described in “Routing transactions dynamically” on page 590)
- Program-link (DPL) requests (described in “Routing DPL requests dynamically” on page 597)
- Non-terminal-related START requests (described in “Routing non-terminal-related START requests” on page 637)

If the user application uses a channel, rather than a communications area, the routing program is given, in field DYRCHANL, the name of the channel. Because the routing program is given the *name* of the channel, not its address, it is unable to use the contents of DYRCHANL to inspect or change the contents of the channel's containers.

However, an application that uses a channel can create, within the channel, a special container named DFHROUTE. If the application issues a LINK or terminal-related START request (but not a non-terminal-related START request) that is to be dynamically routed, the dynamic routing program is given, in the DYRACMAA field of DFHDYPDS, the address of the DFHROUTE container, and can inspect and change its contents.

---

## Routing by user ID

Optionally, your routing program can route requests based on the CICS user ID (userid) associated with the request. The DYRUSERID field of the communications area contains the userid. When it is invoked for routing or because of a route-selection error, your routing program can base its routing decision on the contents of this field. For details of how the userid is set for different types of request, see the description of the DYRUSERID field in “Parameters passed to the dynamic routing program.”

---

## Parameters passed to the dynamic routing program

Figure 59 on page 608 shows all the parameters passed from the CICS relay program, to the dynamic routing program by means of a communications area. The communications area is mapped by the copy book DFHDYPDS, which is in the appropriate CICS library for all the supported programming languages.

	DS	OCL4	Standard header
DYRFUNC	DS	CL1	Function code
DYRCOMP	DS	CL2	Component code
DYRFILL1	DS	CL1	Reserved
DYRERROR	DS	CL1	Route selection error code
DYROPTER	DS	CL1	Transaction termination option
DYRQUEUE	DS	CL1	Queue-the-request indicator
DYRFILL2	DS	CL1	Reserved
DYRRETC	DS	F	Return code
DYRSYSID	DS	CL4	Default/Selected sysid
DYRVER	DS	H	Version of the interface
DYRTYPE	DS	CL1	Type of routing request
DYRFILL3	DS	CL1	Reserved
DYRTRAN	DS	CL8	Default/Selected remote tranid
DYRCOUNT	DS	F	Number of invocations count
DYRBPNTN	DS	F	Address of input buffer
DYRBLGTH	DS	F	Length of input buffer
DYRRTPRI	DS	CL1	Pass priority to AOR?
DYRFILL4	DS	CL1	Reserved
DYRPRTY	DS	H	Dispatch priority passed to AOR
DYRNETNM	DS	CL8	Netname matching sysid
DYRLPROG	DS	CL8	Run this program if routed locally
DYRDTRXN	DS	CL1	DTRTRAN indicator
DYRDTRRJ	DS	CL1	DTRTRAN reject?
DYRFILL5	DS	CL2	Reserved
DYRSRCTK	DS	XL4	MVS WLM service and reporting class token
DYRABNLC	DS	XL4	Abnormal event code
DYRABCDE	DS	CL4	Transaction abend code
DYRCABP	DS	CL1	Continue abend processing?
DYRLEVEL	DS	CL1	Required CICS level of AOR
DYRFILL6	DS	CL2	Reserved
DYRACMAA	DS	F	Address of applications's commarea
DYRACMAL	DS	F	Length of application's commarea
DYRUAPTR	DS	F	Address of user area
* THE FOLLOWING 7 FIELDS APPLY ONLY TO BTS TRANSACTIONS			
DYRCBTS	DS	0CL176	
DYRPROCN	DS	CL36	BTS process name
DYRPROCT	DS	CL8	BTS process-type
DYRACTN	DS	CL16	BTS activity name
DYRACTID	DS	CL52	BTS activity ID
DYRPROCID	DS	CL52	BTS process ID
DYRACTCMP	DS	CL1	BTS activity completing?
DYRPROCCMP	DS	CL1	BTS process completing?
DYRFILL7	DS	CL2	Reserved
DYRUSERID	DS	CL8	CICS userid
DYRBRTK	DS	CL8	BRIDGE FACILITY TOKEN, for Link3270 requests only
DYRUSER	DS	CL1024	User area
DYRCHANL	DS	CL16	Channel name
* DYRUAREA DSECT			
*			
DYRUSERN	DS	CL1024	USER AREA

Figure 59. The communications area passed to a dynamic routing program

## Important

The same communications area is passed to both the dynamic routing program and the distributed routing program. Some parameters are meaningful to one routing program but not to the other. Some parameter-values may be passed to one routing program but never to the other. The following list describes in detail only the parameters that are significant to the dynamic routing program; parameter-values that are never passed to the dynamic routing program are not listed. For example,

under the DYRFUNC parameter the value X'5' is not listed because it is never passed to the dynamic routing program—it occurs only on a route initiate call to the distributed routing program.

If you use the same program as both a dynamic routing program and a distributed routing program, for descriptions of the parameters and values that are significant on distributed routing calls refer to “Parameters passed to the distributed routing program” on page 645.

#### **DYRABCDE**

is the abend code returned when a routed transaction or program-link request abends, or a Link3270 user transaction abends.

#### **DYRABNLC**

is an abnormal event code, or null.

This field is significant when the dynamic routing program is invoked for termination of a routed request. Any value other than null indicates that an abnormal event, *other than a transaction abend*, has occurred in the region to which the request was routed. Your routing program should not route further requests to the same region until the cause of the error has been investigated and rectified.

This field is intended for use by CICSplex System Manager. Currently, it is set only by DB2. For more information, see the *CICS DB2 Guide*.

#### **DYRACMAA**

This field applies to the routing of:

- Terminal-initiated transactions
- Transactions started by terminal-related START commands
- Program-link (DPL) requests

For the routing of these types of request, DYRACMAA contains one of the following:

- If the user application employs a communications area (COMMAREA), the 31-bit address of the application's COMMAREA
- If the user application employs a channel and has created, within the channel, a container named DFHROUTE, the 31-bit address of the DFHROUTE container
- If the user application has no COMMAREA and no DFHROUTE container, null characters

For the routing of all other types of request, DYRACMAA contains null characters.

For the routing of the three types of eligible request listed above, if the user application employs a COMMAREA:

- When your dynamic routing program is invoked for routing (DYRFUNC=0), the address is that of the *input* communications area (if any). Likewise, when your routing program is invoked because of a route-selection error or for notification (DYRFUNC=1 and 3, respectively), the address is that of the input communications area.
- When your routing program is invoked because a previously-routed transaction or link request has terminated normally (DYRFUNC=2), the address is that of the *output* communications area (if any). Routed applications can use their output communications area to pass information to the dynamic routing program.

When your routing program is invoked because the routed transaction has abended (DYRFUNC=4), the information in the communications area, or in the DFHROUTE container, is not meaningful.

Your routing program can alter the data in any application's communications area, or DFHROUTE container, addressed by DYRACMAA.

#### **DYRACMAL**

This field applies to the routing of:

- Terminal-initiated transactions
- Transactions started by terminal-related START commands
- Program-link (DPL) requests

For the routing of these types of request, DYRACMAL contains one of the following numerical values:

- If the user application employs a COMMAREA, the length, in bytes, of the application's COMMAREA
- If the user application employs a channel and has created, within the channel, a container named DFHROUTE, the length, in bytes, of the data in the DFHROUTE container
- If the user application has no COMMAREA and no DFHROUTE container, zero

For the routing of all other types of request, DYRACMAL contains zero.

#### **DYRACTCMP**

is not used by the dynamic routing program. On invocation, it is set to nulls.

#### **DYRACTID**

is not used by the dynamic routing program. On invocation, it is set to nulls.

#### **DYRACTN**

is not used by the dynamic routing program. On invocation, it is set to nulls.

#### **DYRBLGTH**

is the length of the copy of the TIOA/LUC buffer.

This field applies only to dynamic transaction routing, or Link3270 requests (not to the routing of program-link requests).

#### **DYRBPNTR**

is the 31-bit address of a copy of the TIOA/LUC buffer.

This field applies only to dynamic transaction routing (not to the routing of program-link requests).

When your dynamic routing program is invoked for routing, because of a route-selection error, or for notification (DYRFUNC=0, 1, and 3, respectively), it is given a copy of the input TIOA. Your routing program can alter the terminal input data passed to the routed transaction—see “Modifying the initial terminal data” on page 595.

When your routing program is invoked because a previously-routed transaction has terminated normally (DYRFUNC=2), it is given a copy of the output TIOA. Your routing program can monitor the output TIOA to detect possible problems in the AOR—see “Receiving information from a routed transaction” on page 596.

When your routing program is called for a Link3270 bridge request (DYRTYPE=8), the address of a copy of the TIOA/LUC buffer is not passed in DYRBPNTR.



**DYRBRTK**

is the 8-byte bridge facility token associated with a Link3270 bridge request. This field is valid only when DYRTYPE=8.

**DYRCABP**

indicates whether or not you want CICS to continue standard abend processing.

**Note:** This field applies only to dynamic transaction routing, not to the routing of program-link or Link3270 requests. (If a linked-to program abends on a remote region, the abend is mirrored in the local region—that is, it is passed to the program that issued the EXEC CICS LINK command.)

The possible values are:

**Y** Continue with CICS abend processing.

**N** Terminate the transaction, do not continue with CICS abend processing, and give control to the program specified by DYRLPROG.

This option enables you to pass control to a local program that can handle the condition in your own way, and issue appropriate messages to terminal users.

If you enter N, you must ensure that DYRLPROG specifies the name of a valid program on the local system.

There is no default value.

**DYRCHANL**

is the name of the channel, if any, associated with the program-link or START command. This field applies only to the routing of DPL requests, non-terminal-related START requests, and transactions started by terminal-related START requests. For other types of request, or if there is no channel associated with the command, this field contains blanks.

Note that the routing program is given the *name* of the channel, not its address, and so is unable to use the contents of this field to inspect or change the contents of the containers. For information about how the routing program can inspect or change the contents of the application's containers, see "Modifying the application's containers" on page 607 and the description of the DYRACMAA field.

**DYRCOMP**

is the CICS component code. For calls to the dynamic routing program, it is always set to 'RT'.

**DYRCOUNT**

is a count of the times the dynamic routing program has been invoked for this transaction or link request with DYRFUNC set to '0', '1', or '3'. This field allows you to limit the number of times your program tries to route a request.

**DYRDTRRJ**

indicates whether the transaction, which is defined by the common transaction definition specified on the DTRTRAN system initialization parameter, is to be rejected, or accepted for processing.

This field applies only to dynamic transaction routing and Link3270 request routing (not to the routing of program-link requests), and is only relevant when DYRTRXN is set to Y.

The possible values are:

**Y** The transaction is rejected. This is the default.

**N** The transaction is not rejected.

This indicator is always set to the reject condition when the dynamic routing program is invoked. To dynamically route a transaction defined by the DTRTRAN definition, you must change this to the accept condition.

If you reject the transaction, message DFHAC2001—"Transaction '*transid*' is unrecognized"—is sent to the user's terminal for dynamic transaction routing. For Link3270 requests, the BRIH returned to the client will contain a return code indicating that the transaction was not found, and a compcode indicating that the routing program rejected the transaction specified on the DTRTRAN system initialization parameter.

#### **DYRDTRXN**

indicates whether the transaction to be routed is defined by the common transaction definition specified on the DTRTRAN system initialization parameter, or by a specific transaction definition.

This field applies only to dynamic transaction routing and Link3270 requests (not to the routing of program-link requests).

The possible values are:

**Y** The transaction is defined by the definition specified by the system initialization parameter DTRTRAN. That is, there is no resource definition for the input transaction identifier (id).

For dynamic transaction routing, the transaction is initiated in the terminal-owning region using the transaction id specified by the system initialization parameter, DTRTRAN.

For dynamic transaction routing, the input transaction id is passed to the dynamic routing program in the DYRTRAN field. For Link3270 requests the common transaction definition is used to determine the routing characteristics of the request. The request still contains the original transaction id, not the common transaction id. If the request is run locally, the request is passed to the driver successfully, but the driver will fail to start the user transaction as it is not defined.

**N** The transaction is not defined by the definition specified by the system initialization parameter, DTRTRAN. There is an installed resource definition for the input transaction id.

For dynamic transaction routing, the transaction is initiated in the terminal-owning region using the input transaction id. The transaction id passed to the dynamic routing program in the DYRTRAN field is the remote transaction id from the transaction resource definition (if this is different from the input transaction id).

For Link3270 requests, the transaction id passed to the routing program in the DYRTRAN field is the remote transaction id defined in the TRANSACTION resource definition.

For an explanation of the **DTRTRAN** system initialization parameter, see the *CICS System Definition Guide*.

#### **DYRERROR**

has a value only when DYRFUNC is set to '1'. It indicates the type of error that occurred during the last attempt at route selection. The possible values are:

**0** The selected sysid is unknown.

**1** The selected system is not in service.

- 2** The selected system is in service, but no sessions are available.
- 3** An allocate request has been rejected, and SYSIDERR returned to the application program. This error occurs for one of the following reasons:
  - 1. An XZIQUE global user exit program requested that the allocate be rejected, or
  - 2. CICS rejected the allocate request automatically because the QUEUELIMIT value specified on the CONNECTION resource definition has been reached.
- 4** A queue of allocate requests has been purged, and SYSIDERR returned to all the waiting application programs. This error occurs for one of the following reasons:
  - 1. An XZIQUE global user exit program requested that the queue be purged, or
  - 2. CICS purged the queue automatically because the MAXQTIME limit specified on the CONNECTION resource definition has been reached.
- 5** The selected system does not support this function. This occurs if the routing program tries to:
  - 1. Route a transaction initiated by an EXEC CICS START command to a region that is not connected by an MRO or APPC parallel-session link.
  - 2. Route a transaction, or a program-link or Link3270 request, across a LU6.1 connection.
  - 3. Route a Link3270 request to a pre-CICS TS for z/OS, Version 2.2 region.

Values 6–B all apply to attempts to route program-link requests. For the meanings of these error conditions, see the *CICS Application Programming Reference* manual.

- 6** The EXEC CICS LINK command returned LENGERR.
- 7** The EXEC CICS LINK command returned PGMIDERR.
- 8** The EXEC CICS LINK command returned INVREQ.
- 9** The EXEC CICS LINK command returned NOTAUTH.
- A** The EXEC CICS LINK command returned TERMERR.
- B** The EXEC CICS LINK command returned ROLLEDBACK.
- F** The XPCERES global user exit program on the target region has set a return code of UERCRESU, meaning that a required resource is unavailable on the target region. This error code may be set for program-link, Link3270 bridge, and non-terminal-related START requests.

#### **DYRFUNC**

tells you the reason for this invocation of the dynamic routing program. The possible values are:

- 0** Invoked for route selection.
- 1** Invoked because an error occurred in route selection.
- 2** Invoked because a previously routed transaction or program-link request has terminated successfully, or for a request for which the user transaction terminated successfully.

- 3 Invoked for notification of the destination of a statically-routed request. This applies in the following cases:

**ATI requests**

A transaction defined as DYNAMIC(YES) has been initiated by a terminal-related automatic transaction initiation (ATI) request—for example, by the expiry of an interval control start request—but the transaction is ineligible for dynamic routing.

For information about which transactions initiated by terminal-related EXEC CICS START commands are eligible for dynamic routing, see the *CICS Intercommunication Guide*.

**Program-link requests**

The program is defined as DYNAMIC(YES)—or is not defined—but the caller specified the name of a remote region on the SYSID option of the EXEC CICS LINK command.

In this case, specifying the target region explicitly takes precedence over any SYSID returned by the dynamic routing program.

**bridge requests**

In session mode, the requested transaction is not the first user transaction and is defined as DYNAMIC(YES).

- 4 Invoked because the routed transaction or the requested user transaction abended.

The DYRTYPE field tells you the type of routing or notification request.

**DYRLEVEL**

is the level of CICS required in the target AOR to successfully process the routed request. The possible values are:

- X'00'** Any currently-supported version of CICS is able to process the request.
- X'01'** CICS TS for z/OS, Version 2.2. This value may be set only for method requests for enterprise beans and CORBA stateless objects (handled by the *distributed* routing program).
- X'02'** CICS TS for z/OS, Version 2.3. This value may be set only for method requests for enterprise beans and CORBA stateless objects (handled by the *distributed* routing program).
- X'03'** CICS TS for z/OS, Version 3.1. This value may be set for:
  - DPL requests that have a channel associated with them.
  - START requests that have a channel associated with them.
  - Inbound web services requests (handled by the *distributed* routing program).
  - Method requests for enterprise beans and CORBA stateless objects (handled by the *distributed* routing program).
- X'04'** CICS TS for z/OS, Version 3.2.

Note that values greater than X'00' indicate the specific, not the minimum, level of CICS required to process the request successfully.

This parameter is a migration aid, intended to help you perform a rolling upgrade of a multi-region logical server, whereby one region at a time is upgraded from one release of CICS to the next, without bringing down the server. Requests that require a specific level of CICS can be routed to an appropriate AOR.

**Note:** This mixed level of operation, in which different CICS regions in the same logical server are at different levels of CICS, is intended to be used only for rolling upgrades. It should not be used permanently, because it increases the risk of failure in some interoperability scenarios. The normal, recommended, mode of operation is that all the regions in a logical server should be at the same level of CICS and Java.

For definitive information about upgrading CICS EJB/CORBA servers, see the *Java Applications in CICS*.

#### **DYRLPROG**

is the name of the initial program of the transaction to be routed; or the name of the program specified on the link command to be routed.

#### **Transaction routing**

You can use this field to specify the name of an alternative program to be run if the transaction is routed locally. For example, if all remote CICS regions are unavailable, and the transaction cannot be routed, you may want to run a program in the local terminal-owning region to send an appropriate message to the user.

**Note:** DYRLPROG must not be set to blanks when you specify DYRCABP=N. If you specify DYRCABP=N, ensure you also specify a valid program name on DYRLPROG.

#### **Program-link requests**

When DYRFUNC is '0' or '3', DYRLPROG contains the name of the program to be linked, obtained using the following sequence:

1. From the REMOTENAME option of the installed program definition
2. If REMOTENAME is not specified, or there is no program definition, from the PROGRAM option of the EXEC CICS LINK command.

You can use this field to specify that an alternative program, other than that named on the program-link request, is to be linked. You can specify a local or remote program, depending on the region to which the request is to be routed.

**Note:** Be aware that, if you change the value of DYRLPROG, and the alternate program you choose is defined as DYNAMIC(YES), the dynamic routing program will be reinvoked for route selection.

#### **bridge requests**

When DYRTYPE=8, this field should not be changed; any changes made are ignored by CICS.

You can change DYRLPROG on any call to the dynamic routing program, but it is effective only when DYRFUNC is '0' or '1'.

#### **DYRNETNM**

is the netname of the CICS region identified in DYRSYSID.

If the DYRNETNM value is changed by the initial invocation of the dynamic routing program, CICS tries to route the request to the CICS region with the new netname.

#### **DYROPTER**

specifies whether the dynamic routing program is to be reinvoked when the routed transaction or link request terminates (successfully or unsuccessfully). The possible values are:

**N** The dynamic routing program is not to be reinvoked. This is the default.

**Y** The dynamic routing program is to be reinvoked.

You can specify this option for transactions, link requests, or bridge requests that are routed to remote CICS regions and also for those that are executed locally.

**DYRPROCCMP**

is not used by the dynamic routing program. On invocation, it is set to nulls.

**DYRPROCID**

is not used by the dynamic routing program. On invocation, it is set to nulls.

**DYRPROCN**

is not used by the dynamic routing program. On invocation, it is set to nulls.

**DYRPROCT**

is not used by the dynamic routing program. On invocation, it is set to nulls.

**DYRPTY**

can be used to set the dispatch priority of the task in the application-owning region, if the connection between the terminal-owning region and application-owning region is MRO, or when processing a bridge request.

**Transaction routing**

Before invoking the dynamic routing program, CICS sets this value to '0' (zero).

**Program-link requests**

Before invoking the dynamic routing program, CICS sets this value to the priority of the task that issued the program-link request.

**bridge requests**

Before invoking the dynamic routing program, CICS set this value to the value defined in the TRANSACTION resource definition of the user transaction in the router region.

On return from the initial invocation of the dynamic routing program, if the DYRRTPRI value is 'Y' CICS passes the DYRPTY value to the application-owning region.

**DYRQUEUE**

identifies whether or not the request is to be queued if no sessions are immediately available to the remote system identified by DYRSYSID. The possible values are:

**Y** The request is to be queued if necessary. This is the default.

**N** The request is not to be queued.

For bridge requests, DYRQUEUE is set to Y before the dynamic routing program is invoked. Any change made to this value by the user-replaceable program is ignored by CICS.

**DYRRET**

contains a return code that tells CICS how to proceed.

**Transaction routing**

The possible values are:

**0** Continue processing the transaction.

**4** Terminate the transaction without message orabend.

**8** Terminate the transaction with either a message or an abend.

Whenever the routing program is invoked, DYRRETC is set to '0'. When it is invoked for route selection or because an error occurs in route selection, if you want CICS to continue processing the transaction, you must leave it set to '0'.

To make CICS terminate the transaction (issuing a message or abend), return a value of '8'.

To make CICS terminate the transaction without issuing a message or abend (indicating that DFHDYP has done all the processing that is necessary), return a value of '4'.

**Note:**

1. Setting a return code of '4' for APPC transaction routing leads to unpredictable results, and should be avoided.
2. Setting any non-zero return code other than X'4' is equivalent to setting X'8'.

**Program-link requests**

The possible values are:

**0** Continue processing the link request.

**Non-zero**

Return an error condition to the program.

Whenever the routing program is invoked, DYRRETC is set to '0'. When it is invoked for route selection or because an error occurs in route selection, if you want CICS to continue processing the link request, you must leave it set to '0'.

To make CICS reject the link request, return a non-zero value. The program that issued the EXEC CICS LINK command receives a PGMIDERR condition, with a RESP2 value of 27.

**bridge requests**

The possible values are:

**0** Continue processing the request.

**4** Terminate processing the request without issuing any error messages.

**8** Terminate processing the request with an error message.

Whenever the routing program is invoked, DYRRETC is set to '0'. When it is invoked for route selection or because an error occurs in route selection, if you want CICS to continue processing the link request, you must leave it set to '0'.

To make CICS terminate the request without issuing a message return a value of 4. The BRIH returned to the client contains a return code informing the client that the dynamic routing program has rejected the request, and a compcode that gives details of the reason the last attempt to route the request failed.

To make CICS terminate the request (issuing a message) return a value of 8. The BRIH returned to the client contains a return code informing the

client that the dynamic routing program has rejected the request, and a compcode that gives details of the reason the last attempt to route the request failed.

You do not need to set a return code when the routing program is invoked for notification or at transaction termination. (Any code you set is ignored by CICS.)

#### **DYRRTPRI**

indicates whether or not the dispatch priority of the transaction, link request or request should be passed to the application-owning region, if the connection between the terminal-owning region and the application-owning region is MRO. The possible values are:

**N** The dispatch priority is not passed. This is the default.

**Y** The dispatch priority is passed.

#### **DYRSRCTK**

is the MVS workload management service and reporting class token for the routed transaction. Your routing program should not alter this value, which is set by CICS and used by CICSplex SM.

#### **DYRSYSID**

is the system identifier (sysid) of a CICS region. The exact meaning of this parameter depends on the values of DYRFUNC and DYRTYPE:

- When DYRFUNC is set to '0' (route selection):
    - If DYRTYPE is set to '0', '2', '3', or '8' (any type of transaction routing), DYRSYSID contains:
      - The CICS region name specified on the REMOTESYSTEM option of the installed transaction definition, or,
      - If REMOTESYSTEM is not specified, the system name of the local CICS region.
    - If DYRTYPE is set to '4' or '9' (DPL routing), DYRSYSID contains one of the following:
      - The CICS region name specified on the REMOTESYSTEM option of the installed program definition.
- Note:** If the REMOTESYSTEM option names a remote region, the routing program cannot route the request locally.
- If REMOTESYSTEM is not specified, or there is no program definition, the system name of the local CICS region.

The dynamic routing program can accept the value of DYRSYSID or change it before returning to CICS.

If the SYSID you return to CICS is the same as the local sysid, CICS runs the transaction or program in the local region.

- When DYRFUNC is set to '1' (route selection error), DYRSYSID contains the CICS region name returned to CICS by the dynamic routing program on its previous invocation.

The action your dynamic routing program can take when DYRFUNC=1 depends on the DYRERROR parameter setting:

- If DYRERROR is set to '0' (unknown sysid) or '1' (CICS region not in service) and you want CICS to retry routing, you must change DYRSYSID before returning to CICS.



- If DYRERROR is set to '2' (no session available) and you want CICS to retry routing, you must change DYRSYSID or change the value of DYRQUEUE to 'Y' (queue the request until a session is available).
- When DYRFUNC is set to '2' (termination of a routed request), DYRSYSID contains the name of the CICS region on which the completed transaction or link request executed.
- When DYRFUNC is set to '3' (notification):
  - For **ATI requests**, DYRSYSID contains:
    - The remote CICS region name specified on the SYSID option of the EXEC CICS START command, or
    - If SYSID is not specified, the remote CICS region name specified on the REMOTESYSTEM option of the installed transaction definition, or
    - If REMOTESYSTEM is not specified, the system name of the local CICS region.
  - For **program-link requests**, DYRSYSID contains the remote CICS region name specified on the SYSID option of the EXEC CICS LINK command.
  - For **bridge requests**, DYRSYSID contains the SYSID of the CICS region where the request will be routed and the user transaction run.

Any changes to the value of DYRSYSID, or to DYRNETNAME, are ignored.
- When DYRFUNC is set to '4' (abend), DYRSYSID contains the name of the CICS region on which the transaction abended.

#### DYRTRAN

contains the remote transaction id.

##### Transaction routing

When DYRFUNC is set to '0' or '3', DYRTRAN contains the remote transaction id specified on the REMOTENAME option of the installed transaction definition.

##### bridge requests

When DYRTYPE =8, DYRTRAN contains the transaction id of the target user transaction as it is known in the current region. Note that this is not the same as the current transaction id.

##### Program-link requests

When DYRFUNC is set to '0' or '3', DYRTRAN contains the transaction id of the remote mirror transaction, obtained using the following sequence:

1. From the TRANSID option on the LINK command.

**Note:** A value specified on the TRANSID option of the LINK command cannot be overridden by the routing program.

2. From the TRANSID option on the program definition.
3. 'CSMI', the generic mirror transaction. This is the default if neither of the TRANSID options are specified.

Your dynamic routing program can accept this remote transaction id, or supply a different transaction name for forwarding to the remote CICS region. If the supplied name is longer than four characters, it is truncated by CICS.

You can change DYRTRAN on any call to the dynamic routing program, but the change is effective only:

1. When DYRFUNC is set to '0' or '1'.

2. If the original value was *not* obtained from the TRANSID option of an EXEC CICS LINK command. A value specified on the TRANSID option of a LINK command cannot be overridden by the routing program.

#### DYRTYPE

is the type of routing request for which the program is being invoked. For transaction routing, this field is meaningful only when DYRFUNC is set to '0' (route selection) or '3' (notify). The values that can be passed to the *dynamic* routing program are:

- 0 A transaction initiated from a terminal.
- 1 An ATI request that is to be statically routed.
- 2 A transaction started by a terminal-related EXEC CICS START command, where there is no data and no channel associated with the START.
- 3 A transaction started by a terminal-related EXEC CICS START command, where there is data but no channel associated with the START.
- 4 A program-link request without a channel.
- 8 A bridge request.
- 9 A program-link request with a channel.
- A A transaction started by a terminal-related EXEC CICS START command, where there is a channel associated with the START.

#### DYRUAPTR

If DYRVER is '7' or greater, this field contains the address of the new user area (DYRUSERN). The new user area mechanism makes the source of the routing program independent of the CICS release that created the communications area. The old user area field DYRUSER is retained only for compatibility purposes.

The user area can be mapped with the DYRUAREA DSECT.

To ensure that DYRVER is '7' or greater, you must apply the PTFs for the following APARs to any of your routing or target regions at that CICS release:

**CICS Transaction Server for z/OS Version 2 Release 3**  
PQ81378

In systems where DYRUAPTR is less than '7' the contents of DYRUAPTR are unpredictable.

#### DYRUSER

is a 1024-byte user area.

**This field is retained only for compatibility purposes—see the descriptions of the DYRUAPTR and DYRUSERN fields.**

#### DYRUSERID

is the CICS userid associated with the request.

For **transaction routing, program-link requests, and bridge requests**, DYRUSERID contains the userid under which the current transaction is running.

By examining this field when it is invoked for routing or because of a route-selection error (DYRFUNC=0 or 1, respectively), your routing program can route requests based on the userid associated with the request.

**DYRUSERN**

is a 1024-byte user area.

CICS initializes this user area to zeroes before invoking the dynamic routing program for a given task. This user area can be modified by the dynamic routing program; the modified area is passed to subsequent invocations of the dynamic routing program for the same request.

**DYRVER**

is the version number of the dynamic routing program interface. For CICS Transaction Server for z/OS, Version 3 Release 2, the number is "10".

---

## Naming your dynamic routing program

The supplied, user-replaceable dynamic routing program is named DFHDYP. If you write your own version, you can name it differently.

After the system has been loaded, to find the name of the dynamic routing program currently identified to CICS, use the EXEC CICS INQUIRE SYSTEM command. Field DTRPROGRAM contains the name of the current program.

The default is DFHDYP.

To change the current program:

- Use the **DTRPGM** system initialization parameter. For more guidance information about how to do this, refer to the *CICS System Definition Guide*.
- Make the change online using the EXEC CICS SET SYSTEM DTRPROGRAM command. For programming information about this command, refer to the *CICS System Programming Reference*.

**Note:** A sample definition is provided for DFHDYP, but you must install a new resource definition for a customized dynamic routing program.

---

## Testing your dynamic routing program

You can use the CICS execution diagnostic facility (EDF) to test your dynamic routing program. To do so, you must name your program something other than DFHDYP, because you cannot use EDF for programs that begin with "DFH". For details of how to use EDF, see Execution diagnostic facility (EDF), in the *CICS Application Programming Guide*.

You can use EDF in either single- or dual-terminal mode. If you choose single-terminal mode, EDF displays screens for both the dynamic routing program and the application program that is invoked by the routed transaction. The screens relate to:

- The initial invocation of the dynamic routing program for route selection or notification (DYRFUNC=0 or DYRFUNC=3)
- The invocation of the dynamic routing program if an error occurs in route selection (DYRFUNC=1)
- The invocation of the application program
- The termination of the task
- The invocation of the dynamic routing program at termination of the routed transaction or link request (DYRFUNC=2), if you have specified DYROPTER=Y

- The invocation of the dynamic routing program if the routed transaction abends (DYRFUNC=4), if you have specified DYROPTER=Y.

If you want EDF to display the execution of your dynamic routing program only, either choose dual-terminal mode, or use one of the other methods described in Execution diagnostic facility (EDF), in the *CICS Application Programming Guide*.

---

## Dynamic transaction routing sample programs

The CICS-supplied sample dynamic routing program is named DFHDYP. The corresponding copy book that defines the communications area is DFHDYPDS. There are assembler-language, COBOL, PL/I, and C source-level samples and copy books. The supplied programs and copy books, and the CICSTS32.CICS libraries in which they can be found, are summarized in Table 32.

*Table 32. Dynamic transaction routing programs and copy books*

Language	Member name	Library
Programs: Assembler COBOL PL/I C	DFHDYP DFHDYP DFHDYP DFHDYP	SDFHSAMP SDFHCOB SDFHPL1 SDFHC370
Copy books: Assembler COBOL PL/I C	DFHDYPDS DFHDYPDS DFHDYPDS DFHDYPDS	SDFHMAC SDFHCOB SDFHPL1 SDFHC370

You can write your own dynamic routing program in COBOL, PL/I, C, or assembler language, and you can change the name of the program.

When invoked with DYRFUNC set to '0', the sample programs accept the sysid and remote transaction name that are passed in fields DYRSYSID and DYRTRAN of the communications area, and set DYRRETC to '0' before returning to CICS. When invoked with DYRFUNC set to '2' or '3', they set a return code of '0'. When invoked with DYRFUNC set to '1' or '4', they set a return code of '8'.

If you want to route transactions or DPL requests dynamically, you must customize DFHDYP, replace it completely with your own routing program, or use CICSplex System Manager.

---

## Chapter 18. Writing a distributed routing program

You can write your own distributed routing program or use the default program that is provided with CICS.

You must be familiar with the principles of dynamic and distributed routing that are described in the *CICS Intercommunication Guide*, the *CICS Business Transaction Services*, and *Java Applications in CICS*.

You can use the distributed routing program to route:

- CICS business transaction services (BTS) processes and activities
- Method requests for enterprise beans and CORBA stateless objects
- Non-terminal-related EXEC CICS START requests.

For detailed information about which non-terminal-related START requests are eligible for distributed routing, see the *CICS Intercommunication Guide*.

- Inbound Web service requests

### Note:

1. You cannot use the distributed routing program—that is, the program named on the **DSRTPGM** system initialization parameter—to route:
  - Transactions initiated from user terminals
  - Transactions initiated by terminal-related EXEC CICS START commands
  - Program-link requests.

To route these, you must use the dynamic routing program named on the **DTRPGM** system initialization parameter. How to write a dynamic routing program is described in Chapter 17, “Writing a dynamic routing program,” on page 589.

2. The dynamic routing program and the distributed routing program may be the same program.

### Important

If you use the CICSplex System Manager (CICSplex SM) product to manage your CICSplex, you may not need to write a distributed routing program. CICSplex SM provides a fully-functioning routing program, EYU9XLOP, that supports workload balancing and workload separation. All you have to do is tell CICSplex SM, through its user interface, which regions in the CICSplex can participate in the workload, and define any transaction affinities that govern the regions to which particular requests must be routed. For introductory information about CICSplex SM, see the *CICSplex SM Concepts and Planning* manual.

The rest of the section is divided as follows:

1. “Differences between the distributed and dynamic routing interfaces” on page 624
2. “Routing BTS activities” on page 625
3. “Routing method requests for enterprise beans and CORBA stateless objects” on page 629
4. “Routing non-terminal-related START requests” on page 637
5. “Routing inbound Web service requests” on page 641

6. “Routing by user ID” on page 644
7. “Dealing with an abend on the target region” on page 644
8. “Some processing considerations” on page 645
9. “Parameters passed to the distributed routing program” on page 645
10. “Naming your distributed routing program” on page 656
11. “Distributed transaction routing sample programs” on page 657

---

## Differences between the distributed and dynamic routing interfaces

This section discusses some significant ways in which the distributed routing interface differs from the dynamic routing interface. If you have previously written a dynamic routing program, and are about to write a distributed routing program, bear in mind that:

1. The dynamic routing program is only invoked if the resource (the transaction or program) is defined as DYNAMIC(YES). The distributed routing program, on the other hand, is invoked (for BTS activities that are run asynchronously, eligible method requests for enterprise beans and CORBA stateless objects, and eligible non-terminal-related START requests) even if the associated transaction is defined as DYNAMIC(NO)—though it cannot route the request. What this means is that the distributed routing program is better able to monitor the effect of statically-routed requests on the relative workloads of the target regions.
2. Because the dynamic routing program uses the hierarchical “hub” routing model—one routing program controls access to resources on several target regions—the *routing program that is invoked at termination of a routed request is the same program that was invoked for route selection*.

The distributed routing program, on the other hand, uses the distributed model, which is a peer-to-peer system; the routing program itself is distributed. *The routing program that is invoked at initiation, termination, or abend of a routed transaction is not the same program that was invoked for route selection—it is the routing program on the target region.*

Because the dynamic routing program is invoked only on the routing region, the order of its invocations is strictly defined:

- a. Route selection or notification
- b. Route selection error (if appropriate, and possibly repeated)
- c. Transaction termination or abend (if requested).

For a single request, the user area passed to each invocation of the dynamic routing program is the same piece of storage; any modifications made to the user area on one invocation are retained and passed to the next invocation.

The distributed routing program, on the other hand, may be invoked on the target region as well as on the routing region; because of this, the order of its invocations is less strictly defined. For example, the final invocation on the routing region (for “routing attempt complete”) may occur before or after the first invocation on the target region (for “transaction initiation”). To cope with this uncertainty, the user area passed to the distributed routing program on its first invocation on the target region is a *copy* of the user area on the routing region. This means that any modifications to the user area made on the target region have no effect on the user area in the routing region. For more details, see the description of the DYRUSER field in “Parameters passed to the distributed routing program” on page 645.

3. The distributed routing program is invoked at more points than the dynamic routing program. Figure 60 on page 627 shows the points at which the distributed routing program is invoked, and the region on which each invocation occurs.
  4. Unlike the dynamic routing program, the distributed routing program **cannot**:
    - Select a target region by supplying a netname (any value set in the DYRNETNM field of the communications area is ignored). The target must be specified by its CICS system identifier (sysid).
    - Change the remote transaction name passed to the target region. (Any value set in the DYRTRAN field of the communications area is ignored.)
    - Change the initial program associated with a routed request. (Any value set in the DYRLPROG field of the communications area is ignored.)
    - Choose that the request is not to be queued if there are no MRO sessions to the target region. (The DYRQUEUE field of the communications area is always set to 'Y'.)
    - Modify the routed application's communications area. (The routing program is not passed the address of the routed application's communications area in field DYRACMAA.)
    - Pass the dispatch priority of the transaction to the target region. (The DYR RTPRI field of the communications area is always set to 'N'.)
- These restrictions are documented more fully in the descriptions of the relevant fields in the DFHDYPDS communications area.

---

## Routing BTS activities

This section describes how to use a distributed routing program to dynamically route CICS business transaction services (BTS) processes and activities. It assumes that you have read the introduction to the distributed routing of BTS processes and activities in *Using BTS in a sysplex*, in the *CICS Business Transaction Services* manual.

## Which BTS activities can be dynamically routed?

Not all activations of BTS processes and activities can be routed.

Processes and activities that are activated asynchronously with the requestor—by means of a RUN ASYNCHRONOUS command—can be routed either dynamically or statically.

Processes and activities that are activated synchronously with the requestor—by means of a RUN SYNCHRONOUS or LINK command—are always run locally. They cannot be routed, *neither dynamically nor statically*. A RUN SYNCHRONOUS or LINK command issued against an activity whose associated transaction is defined as DYNAMIC(YES), or as residing on a remote region, results in the activity being run locally.

Thus, to be eligible for dynamic routing:

1. A BTS process or activity must be run asynchronously with the requestor, by means of a RUN ASYNCHRONOUS command.
2. The TRANSACTION definition for the transaction associated with the process or activity must specify DYNAMIC(YES).

“Daisy-chaining” is not supported. That is, once a BTS activity has been routed to a target region it cannot be re-routed from the target to a third region, even though its associated transaction is defined as DYNAMIC(YES).

## When the distributed routing program is invoked

For BTS processes and activities started by RUN ASYNCHRONOUS commands, CICS invokes the distributed routing program at the following points:

### On the routing region:

1. Either of the following:
  - For routing the activity. This occurs when the transaction associated with the activity is defined as DYNAMIC(YES).
  - For notification of a statically-routed request. This occurs when the transaction associated with the activity is defined as DYNAMIC(NO). The routing program is not able to route the activity. It could, however, do other things.
2. If an error occurs in route selection—for example, if the target region returned by the routing program on the route selection call is unavailable. This gives the routing program the opportunity to specify an alternate target. This process iterates until the routing program selects a target that is available or sets a non-zero return code.
3. After CICS has tried (successfully or unsuccessfully) to route the activity to the target region.

This invocation signals that (unless the routing region and the target region are one and the same) the routing region’s responsibility for this transaction has been discharged. The routing program might, for example, use this invocation to release any resources that it has acquired on behalf of the transaction.

### On the target region:

*These invocations occur only if the target region is CICS TS OS/390, Version 1.3 or later and the routing program on the routing region has specified that it should be reinvoked on the target region:*

1. When the activation starts on the target region (that is, when the transaction that implements the activity starts).
2. If the routed activation (transaction) ends successfully.
3. If the routed activation (transaction) abends.

Figure 60 on page 627 shows the points at which the distributed routing program is invoked, and the region on which each invocation occurs. Note that the “target region” is not necessarily remote—it could be the local (routing) region, if the routing program chooses to run the activity locally.



### Requesting/routing region

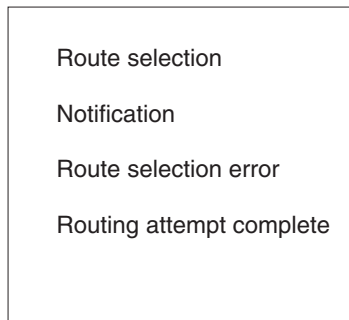

### Target region

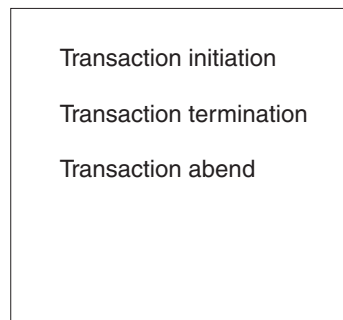

Figure 60. When and where the distributed routing program is invoked

## Changing the target CICS region

The DYRSYSID field of the communications area passed to the distributed routing program initially contains the system identifier (sysid) of the default target region to which the process or activity is to be routed. This is derived from the value of the REMOTESYSTEM option of the installed transaction definition on the routing region. If REMOTESYSTEM is not specified, the sysid passed is that of the local CICS region.

When it is invoked for route selection, the distributed routing program can change the target region by changing the value in DYRSYSID.

If the specified sysid is invalid, or cannot be found, SYSIDERR is returned to the distributed routing program—which may deal with the error by returning a different sysid—see “If an error occurs in route selection” on page 628.

If the routing program changes the sysid when it is invoked for notification, routing complete, transaction initiation, transaction termination, or abend, the change has no effect.

## Telling CICS whether to route the activity

When the routing program is invoked for routing, if you want the process or activity to be routed (whether you have changed any values or not) return a zero value to CICS in field DYRRETC of the communications area. When you return control to CICS with return code zero, CICS first compares the returned sysid with its own local sysid:

- If the sysids are the same (or the returned sysid is blank) CICS executes the RUN request locally. When it executes the request locally, CICS writes message DFHSH0102 to the CSSH transient data queue.
- If the two sysids are not the same, CICS routes the request to the remote CICS region.

If you want CICS to treat the request as *unserviceable*, return a non-zero value. For information about unserviceable requests, see *Dealing with unserviceable requests*, in the *CICS Business Transaction Services* manual.

Returning a value in DYRRETC has no effect when the routing program is invoked for notification, routing complete, transaction initiation, transaction termination, or abend.

## If an error occurs in route selection

If an error occurs in route selection—for example, if the sysid returned by the distributed routing program is unavailable or unknown—the distributed routing program is invoked again. When this happens, you have a choice of actions:

1. You can try to route the request to a different target region, by changing the sysid, and issuing a return code of '0' in DYRRETC.

If this region too is unavailable, the routing program is again invoked for a route selection error. A count of the times the routing program has been invoked for routing purposes for this request is passed in field DYRCOUNT. Use this count to help you decide when to stop trying to route the request.

2. You can tell CICS to treat the request as “unserviceable”, by issuing a non-zero return code in DYRRETC.

Sometimes, perhaps because of a transaction affinity, it is essential that an activity should execute on a particular target region, and on no other. If this is the case, and the target region is unavailable, classify the request as unserviceable. Instead of reinvoking the routing program for a route selection error, CICS:

- a. Tries repeatedly to route the request to the specified target region, at 1-minute intervals.

If one of these attempts is successful, CICS issues message DFHSH0108. The routing program is invoked on the routing region for “routing attempt complete”, and, if specified, on the target region for “transaction initiation”.

- b. Every hour, if the target region is still unavailable, issues message DFHSH0106.
- c. If the target region is still unavailable 24 hours after the request was issued, issues message DFHSH0107, and stops trying to route the request, which is discarded. The routing program is invoked on the routing region for “routing attempt complete”.

## Invoking the distributed routing program on the target region

The route selection, notification, route selection error, and routing complete invocations of the distributed routing program all occur on the routing region. If the routing program wants to be re-invoked *on the target region*, it must set the DYROPTER field in the communications area to 'Y'. It must do this on its initial (route selection or notification) invocation—and again, if it is reinvoked for a route selection error.

If the routing program sets DYROPTER to 'Y', it is re-invoked on the target region:

- When the activation is about to be initiated on the target region
- If the routed activation (transaction) terminates successfully
- If the routed activation (transaction) abends.

Each time it is invoked on the target region, the routing program could update a count of BTS activities that are currently running on that region. When it is invoked for routing, the routing program could use the counts maintained by all the regions in the routing set (including itself) as input to its routing decision. This requires that each region in the routing set has access to a common data set on which the counts are recorded.

## Routing method requests for enterprise beans and CORBA stateless objects

This section describes how to use a distributed routing program to dynamically route method requests for enterprise beans and CORBA stateless objects. It assumes that you have read the introduction to the distributed routing of such requests in Logical servers-enterprise beans in a sysplex, in the *Java Applications in CICS* manual.

### Where workload balancing occurs

Workload balancing of method requests for enterprise beans and CORBA stateless objects occurs at two levels, as shown in Figure 61.

Figure 61 shows a typical CICS logical EJB/CORBA server. The logical server consists of:

- A set of cloned **listener regions** defined by identical TCPIP SERVICE definitions to listen for incoming IIOF requests.
- A set of cloned application-owning regions (AORs), each of which supports an identical set of enterprise bean classes and CORBA stateless objects in an identically-defined CorbaServer execution environment. (Each cloned AOR might contain multiple CorbaServers.)

Typically, as in this example, the listener regions and AORs are in separate groups; in some servers they may be combined into listener/AORs.

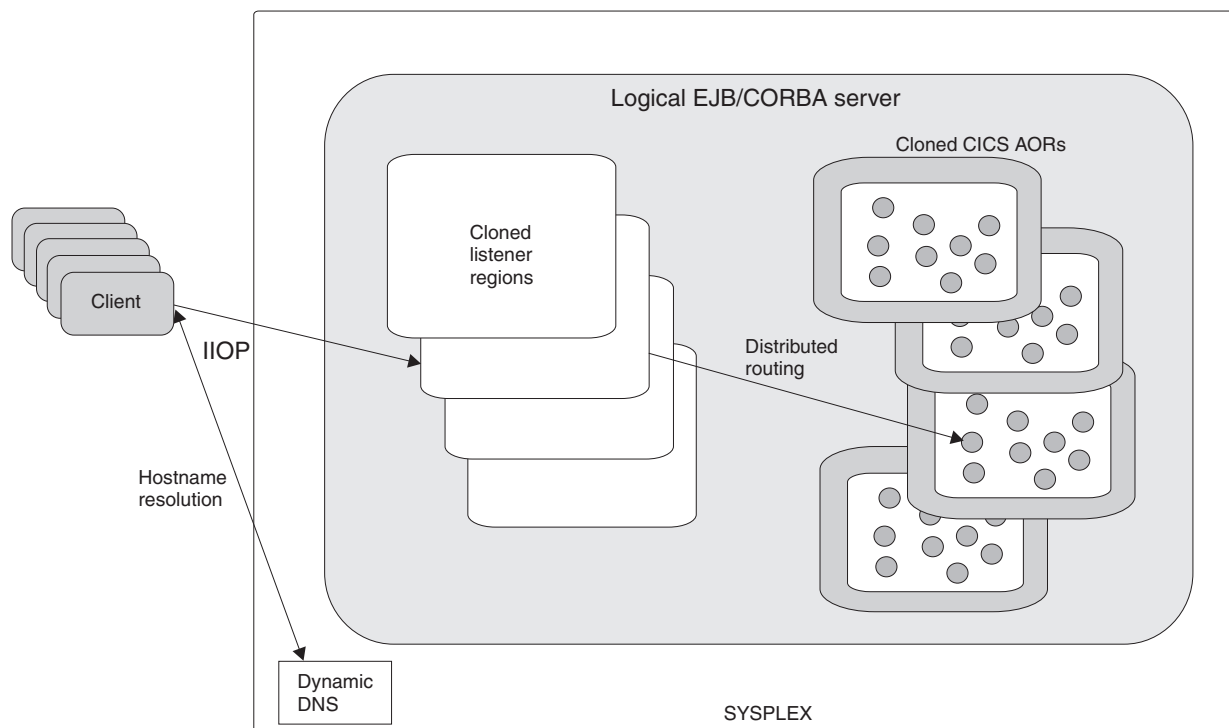

Figure 61. A CICS logical EJB/CORBA server. The logical server consists of a set of cloned “listener” regions and a set of cloned AORs. In this example, connection optimization by means of dynamic DNS registration is used to balance client connections across the listener regions. Distributed routing is used to balance OTS transactions across the AORs.

Workload balancing occurs at two levels:

1. Client connections can be balanced across the listener regions, using any of the following methods:
    - Connection optimization by means of dynamic Domain Name System (DNS) registration.
    - IP routing.
    - A combination of connection optimization and IP routing.
  2. OTS transactions can be balanced across the AORs, using either of the following:
    - CICSplex System Manager
    - A customized version of the CICS distributed routing program, DFHDSRP.
- This chapter assumes that you are using the distributed routing program.

### **Important**

It is convenient to talk of balancing (or dynamically routing) OTS transactions across AORs. Strictly speaking, however, what are dynamically routed are *method requests* for enterprise beans and CORBA stateless objects. There is a correspondence between routing method requests dynamically and routing OTS transactions dynamically: CICS invokes the routing program for requests for methods that will run under a *new* OTS transaction, but not for requests for methods that will run under an *existing* OTS transaction—these it directs automatically to the AOR in which the existing OTS transaction runs. However, because requests for methods that will run under *no OTS transaction* can also be dynamically routed, the correspondence is not exact.

We must be clear about what we mean by “new” and “existing” OTS transactions. For the purposes of this chapter:

- a. By a “**new**” OTS transaction we mean an OTS transaction *in which the target logical server is not already participating*, prior to the current method call; *not* necessarily an OTS transaction that was started immediately before the method call.
- b. By an “**existing**” OTS transaction we mean an OTS transaction *in which the target logical server is already participating*, prior to the current method call; *not* simply an OTS transaction that was started some time ago.

For example, if a client starts an OTS transaction, does some work, and then calls a method on an enterprise bean, so far as the CICS EJB server is concerned this is a “new” OTS transaction, because the server has not been called within this transaction’s scope before. If the client then makes a second and third method call to the same target object, before committing its OTS transaction, these second and third calls occur within the scope of the existing OTS transaction.

### **Local and remote clients**

Figure 61 on page 629 shows the typical situation, where the method requests to be dynamically routed are issued by remote clients over a network connection. For *eligible requests*, the distributed routing program is invoked for route selection in the listener region. (Which method requests are eligible for distributed routing is described in “Which requests can be dynamically routed?” on page 631.)

However, the “client” may not be a program on a remote workstation. It could, for example, be an instance of an enterprise bean or CORBA stateless object, running

on the local EJB/CORBA server, that issues a request for another bean. What happens next depends on whether or not the target object belongs to the local EJB/CORBA server:

- If the request is for an object owned by the local EJB/CORBA server (that is, the CORBASERVER name on the REQUESTMODEL definition is the name of the local CorbaServer):
  - If the transaction attribute of the called method does not require the caller's unit of work to be suspended and resumed around the call, for optimization reasons the called method executes on the local (requesting) region. The distributed routing program is not invoked.
  - If the transaction attribute of the called method requires the caller's unit of work to be suspended and resumed around the call, the called method may be routed to another region. For eligible requests, the distributed routing program is invoked for route selection on the requesting region.
- If the request is for an object owned by a remote EJB/CORBA server, CICS passes the request to the remote server. For eligible requests, the distributed routing program is invoked for route selection on the listener region of the remote server.

## Which requests can be dynamically routed?

Not all method requests for enterprise beans or CORBA stateless objects can be routed dynamically. The distributed routing program is invoked for route selection only when there is a “free choice” of target region. *Requests for methods that are to run under the same OTS transaction are always routed to the same AOR (even if they are handled by different listener regions).* Thus, the routing program is only invoked for routing of method requests in two cases:

1. The method of the target object is to run under a new OTS transaction. (See our definition of what constitutes a “new” OTS transaction, in the “**Important**” labeled box above.)
2. The method of the target object is to run under no OTS transaction.

### Note:

1. A new OTS transaction may be started by:
  - The client
  - The container for the duration of the method
  - The target method—if the target is an instance of a session bean that manages its own OTS transactions.
2. Whether the method of the target object is run under the client's (new or existing) OTS transaction, under the target bean's (new or existing) OTS transaction, under a new OTS transaction created by the container for the duration of the method, or under no OTS transaction, depends on a combination of factors. For example:
  - For enterprise beans:
    - The setting of the target method's transaction attribute
    - The type of bean—stateful session or stateless session
    - For stateful session beans, whether the target object has started an OTS transaction during a previous method and, if so, whether it has committed or rolled back the transaction.
  - For CORBA stateless objects:

- Whether or not the target object implements `CosTransactions::TransactionalObject`.
- Whether or not the client has an OTS transaction when it issues the method request; and, if so, whether it has issued a previous method request to the same target object within the scope of the same OTS transaction.

The routing program is **not** invoked for route selection when the requested method of the target object is to run under an existing OTS transaction. (See our definition of what constitutes a “existing” OTS transaction, in the “**Important**” labeled box above.) There are two reasons for a method to be associated with an existing OTS transaction:

1. A client makes a second or subsequent method call to the same server object within the scope of the same client OTS transaction, and the called methods support an external transaction coordinator. For example, a client calls a series of methods with transaction attribute 'Supports' on a single enterprise bean instance under a single OTS transaction. The method request carries a transaction service context containing the OTS transaction ID (TID).
2. A client makes a method call to a stateful session bean object that has started an OTS transaction in a previous method and not yet committed or rolled back the transaction.

Thus, to be eligible for to be eligible for dynamic routing:

1. A request *must not be for a method that is to run under an existing OTS transaction*.
2. The transaction associated with the method request—that is, the transaction specified on the REQUESTMODEL definition—must specify `DYNAMIC(YES)`.

“Daisy-chaining” is not supported. That is, once a method request has been routed to a target region it cannot be re-routed from the target to a third region.

## When the distributed routing program is invoked

For method requests for enterprise beans and CORBA stateless objects, where the method is to run under a new OTS transaction or under no OTS transaction, CICS invokes the distributed routing program at the following points:

### On the routing region:

1. Either of the following:
  - For route selection. This occurs when the transaction associated with the method request—that is, the transaction specified on the REQUESTMODEL definition—is defined as `DYNAMIC(YES)`.
  - For notification of a statically-routed request. This occurs when the transaction associated with the request is defined as `DYNAMIC(NO)`. The routing program is not able to route the request. It could, however, do other things.
2. If an error occurs in route selection—for example, if the target region returned by the routing program on the route selection call is unavailable. This gives the routing program the opportunity to specify an alternate target. This process iterates until the routing program selects a target that is available or sets a non-zero return code.
3. After CICS has tried (successfully or unsuccessfully) to route the request to the target region.

This invocation signals that (unless the routing region and the target region are one and the same) the routing region's responsibility for this request has been discharged.

**On the target region:**

*These invocations occur only if the target region is CICS TS for z/OS, Version 2.1 or later and the routing program on the routing region has specified that it should be reinvoked on the target region:*

1. When the routed method starts on the target region. That is, when the CICS transaction specified on the REQUESTMODEL definition starts.
2.
  - If the routed method is part of an OTS transaction, if the OTS transaction ends successfully.
  - If the method executes outside an OTS transaction, if the method itself ends successfully.

That is, if the CICS transaction specified on the REQUESTMODEL definition ends successfully.

3.
  - If the routed method is part of an OTS transaction, if the OTS transaction abends.
  - If the method executes outside an OTS transaction, if the method itself abends.

That is, if the CICS transaction specified on the REQUESTMODEL definition abends.

Figure 62 shows the points at which the distributed routing program is invoked, and the region on which each invocation occurs. Note that the “target region” is not necessarily remote—it could be the local (routing) region, if the routing program chooses to run the method locally.

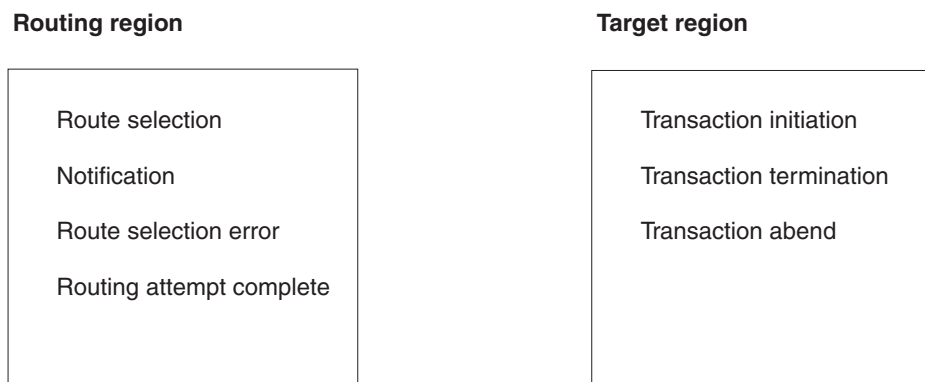

Figure 62. When and where the distributed routing program is invoked

## Changing the target CICS region

The DYRSYSID field of the communications area passed to the distributed routing program initially contains the system identifier (sysid) of the default target region to which the method request is to be routed. This is derived from the value of the REMOTESYSTEM option of the installed transaction definition (for the transaction specified on the REQUESTMODEL definition) on the routing region. If REMOTESYSTEM is not specified, the sysid passed is that of the local CICS region.

When it is invoked for route selection, the distributed routing program can change the target region by changing the value in DYRSYSID.

If the specified sysid is invalid, or cannot be found, SYSIDERR is returned to the distributed routing program—which may deal with the error by returning a different sysid—see “If an error occurs in route selection.”

If the routing program changes the sysid when it is invoked for notification, routing complete, transaction initiation, transaction termination, or abend, the change has no effect.

## Telling CICS whether to route the method request

When the routing program is invoked for routing, if you want the method request to be routed (whether you have changed any values or not) return a zero value to CICS in field DYRRETC of the communications area. When you return control to CICS with return code zero, CICS first compares the returned sysid with its own local sysid:

- If the sysids are the same (or the returned sysid is blank) CICS executes the request locally.
- If the two sysids are not the same, CICS routes the method request to the remote CICS region.

If you want CICS to reject the request, return a non-zero value. The client program receives an exception condition, indicating that the request has been rejected by the routing program.

Returning a value in DYRRETC has no effect when the routing program is invoked for notification, routing complete, transaction initiation, transaction termination, or abend.

## If an error occurs in route selection

If an error occurs in route selection—for example, if the sysid returned by the distributed routing program is unavailable or unknown—CICS places the reason for the failure in field DYRERROR of the communications area and invokes the distributed routing program again. When this happens, you have a choice of actions:

1. You can try to route the request to a different target region, by changing the sysid, and issuing a return code of '0' in DYRRETC.

If this region too is unavailable, the routing program is again invoked for a route selection error. A count of the times the routing program has been invoked for routing purposes for this request is passed in field DYRCOUNT. Use this count to help you decide when to stop trying to route the request.

2. You can tell CICS to reject the request, by issuing a non-zero return code in DYRRETC.

## Invoking the distributed routing program on the target region

The route selection, notification, route selection error, and routing complete invocations of the distributed routing program all occur on the routing region. If the routing program wants to be re-invoked *on the target region*, it must set the DYROPTER field in the communications area to 'Y'. It must do this on its initial (route selection or notification) invocation—and again, if it is reinvoked for a route selection error.



If the routing program sets DYROPTER to 'Y', it is re-invoked on the target region:

1. When the routed method starts on the target region. That is, when the CICS transaction specified on the REQUESTMODEL definition starts.
2.
  - If the routed method is part of an OTS transaction, if the OTS transaction ends successfully.
  - If the method executes outside an OTS transaction, if the method itself ends successfully.

That is, if the CICS transaction specified on the REQUESTMODEL definition ends successfully.

3.
  - If the routed method is part of an OTS transaction, if the OTS transaction abends.
  - If the method executes outside an OTS transaction, if the method itself abends.

That is, if the CICS transaction specified on the REQUESTMODEL definition abends.

Each time it is invoked on the target region, the routing program could update a count of OTS transactions and “standalone” enterprise bean and CORBA stateless object methods that are currently running on that region. When it is invoked for routing, the routing program could use the counts maintained by all the regions in the routing set (including itself) as input to its routing decision. This requires that each region in the routing set has access to a common data set on which the counts are recorded.

## Dealing with a disabled CorbaServer

It is possible for a routed request to fail, on the target region, because the target CorbaServer is disabled. (Perhaps maintenance is being applied to the CorbaServer.) CICS indicates that this has happened by invoking the routing program for transaction abend and returning an abend code of 'AIID' in the DYRABCDE field of the communications area. Note that this invocation occurs on the *target* region, and then only if the routing program has specified, on a previous call on the routing region, that it should be reinvoked, on the target region, for transaction initiation, termination, and abend.

How you handle a disabled CorbaServer may depend on whether or not the AORs in your routing set contain multiple CorbaServers:

- If the AORs contain only a single CorbaServer, you must remove the AOR containing the disabled CorbaServer from the routing set until the CorbaServer is re-enabled.
- If the AORs contain multiple CorbaServers, you could code your routing program so that the program does *not* remove the AOR from its routing set. It redirects the failed request to a different AOR, but recognizes that the first AOR remains a valid target for requests for objects supported by its other CorbaServers.

**Note:** If your AORs contain multiple CorbaServers you are strongly advised to assign different sets of transaction IDs to the objects supported by each CorbaServer. That is, each CorbaServer in an AOR should support a different set of transaction IDs. This makes it easier to isolate methods that run in a disabled CorbaServer from methods that run in other, enabled, CorbaServers.

In general, you should follow the guidelines in Updating enterprise beans in a production region, in the *Java Applications in CICS* manual about how to organize beans, CorbaServers, and transaction IDs to facilitate maintenance.

One way of dealing with a disabled CorbaServer is as follows:

1. If your AORs contain multiple CorbaServers, ensure that you assign different sets of transaction IDs to the objects supported by each CorbaServer.
2. Code your routing program to handle abends on the target region—see “Dealing with an abend on the target region” on page 644. That is:
  - a. On each route selection (and route selection error) call, the routing program specifies that it is to be reinvoked (for transaction initiation, termination, and abend) on the target region—see “Invoking the distributed routing program on the target region” on page 634.
  - b. If the routing program is invoked, on the target region, for transaction abend, it conveys full details of the failed request to the routing region. It could, for example, write the communications area to a shared resource, such as an RLS file or a shared data table.
  - c. The routing program on the routing region checks the shared resource at predetermined intervals.
  - d. When the routing program on the routing region discovers that a routed request has failed, it checks the abend code in field DYRABCDE of the saved communications area. An abend code of 'AIID' indicates that the request failed because the target CorbaServer on the target region is disabled.
3. When the routing program on the routing region discovers that a routed request has failed due to a disabled CorbaServer:
  - If the target region contains only the single (disabled) CorbaServer, the routing program:
    - a. Removes the target region from its routing set.
    - b. Retries the request on another region. It tries repeatedly until either the request is successful or all possible AORs have been tried unsuccessfully. (In the latter case, an error response is returned to the client. However, it's unlikely that you will have disabled the equivalent CorbaServer in all the AORs simultaneously; so one of these retried requests is likely to succeed.)
  - If the target region contains multiple CorbaServers, the routing program:
    - a. Tries to route the request to a different AOR in the routing set. It tries repeatedly until either the request is successful or all possible AORs have been tried unsuccessfully.
    - b. Retrieves the transaction name under which the method request runs from field DYRTRAN of the saved communications area. Marks this transaction as unavailable in this AOR (and in any other AORs that have been tried unsuccessfully). The routing program will route any new requests for objects that run under this same transaction to AORs in which the transaction is not marked as unavailable.

Thus, the AOR containing the disabled CorbaServer remains part of the routing set. Requests for objects in enabled CorbaServers in the region, that run under transaction IDs not marked as unavailable, will succeed. Requests for objects in the disabled CorbaServer will be re-routed, or fail.

## Performing a rolling upgrade of an EJB/CORBA server

The DYRLEVEL field of the communications area is a migration aid, intended to help you perform a “rolling upgrade” of a multi-region logical server, whereby one region at a time is upgraded from one release of CICS to the next, without bringing down the server. Requests that require a specific level of CICS can be routed to an appropriate AOR. For details, see DYRLEVEL.

### Important

#### Note:

1. This mixed level of operation, in which different CICS regions in the same logical server are at different levels of CICS, is intended to be used only for rolling upgrades. It should not be used permanently, because it increases the risk of failure in some interoperability scenarios. The normal, recommended, mode of operation is that all the regions in a logical sever should be at the same level of CICS and Java.
2. Do not attempt to use the DYRLEVEL field until you have read the definitive information about upgrading CICS EJB/CORBA servers in *Migrating an EJB server to CICS Transaction Server for z/OS, Version 3 Release 2*, in the *Java Applications in CICS*.

---

## Routing non-terminal-related START requests

This section describes how to use a distributed routing program to dynamically route non-terminal-related EXEC CICS START requests.

### Which requests can be dynamically routed?

For a non-terminal-related START request to be eligible for dynamic routing, all of the following conditions must be met:

- The request is eligible for *enhanced* routing. For general information about the “enhanced” method of routing transactions invoked by EXEC CICS START commands, and for specific information about which non-terminal-related START requests are eligible for enhanced routing, see *Routing transactions invoked by START commands*, in the *CICS Intercommunication Guide*.
- The transaction definition in the routing region specifies both ROUTABLE(YES) and DYNAMIC(YES).
- The SYSID option of the START command does not specify the name of a remote region. (That is, the remote region on which the transaction is to be started must not be specified explicitly.)

If the request is fully eligible for dynamic routing, the distributed routing program is invoked for routing. The START request is function-shipped to the target region returned by the routing program.

#### Note:

1. If the request is ineligible for enhanced routing, the distributed routing program is not invoked. Unless the SYSID option of the START command specifies a remote region explicitly, the START request is function-shipped to the target region named in the REMOTESYSTEM option; if REMOTESYSTEM is not specified, the START executes locally.
2. If the request is eligible for enhanced routing but not for dynamic routing (the transaction may, for example, be defined as DYNAMIC(NO)) the

distributed routing program is invoked for notification only—it cannot route the request. Unless the SYSID option of the START command specifies a remote region explicitly, the START request is function-shipped to the target region named in the REMOTESYSTEM option; if REMOTESYSTEM is not specified, the START executes locally.

“Daisy-chaining” is not supported. That is, once a non-terminal-related START request has been dynamically routed to a target region it cannot be dynamically routed from the target to a third region, even though the transaction is defined as ROUTABLE(YES) and DYNAMIC(YES). The transaction may, however, be *statically* routed from the target region to a third region.

For definitive information about which non-terminal-related START requests are eligible for dynamic routing, see Non-terminal-related START commands, in the *CICS Intercommunication Guide*.

## When the distributed routing program is invoked

For non-terminal-related START requests that are eligible for enhanced routing, CICS invokes the distributed routing program at the following points:

### On the routing region:

1. Either of the following:
  - For routing the request.
  - For notification of a statically-routed request. This occurs when a transaction defined as ROUTABLE(YES) is eligible for *enhanced* routing but not for *dynamic* routing because one or both of the following applies:
    - The transaction definition specifies DYNAMIC(NO).
    - The SYSID option of the START command names a remote region explicitly.

The routing program is not able to route the request. It could, however, do other things.

2. If an error occurs in route selection—for example, if the target region returned by the routing program on the route selection call is unavailable. This gives the routing program the opportunity to specify an alternate target. This process iterates until the routing program selects a target that is available or sets a non-zero return code.
3. After CICS has tried (successfully or unsuccessfully) to route the request to the target region.

This invocation signals that (unless the routing region and the target region are one and the same) the routing region’s responsibility for this transaction has been discharged. The routing program might, for example, use this invocation to release any resources that it has acquired on behalf of the transaction.

### On the target region:

*These invocations occur only if the target region is CICS TS OS/390, Version 1.3 or later and the routing program on the routing region has specified that it should be reinvoked on the target region:*

1. When the transaction associated with the request starts on the target region.
2. If the transaction ends successfully.
3. If the transaction abends.

Figure 63 shows the points at which the distributed routing program is invoked, and the region on which each invocation occurs. Note that the “target region” is not necessarily remote—it could be the local (routing) region, if the routing program chooses to execute the START request locally.

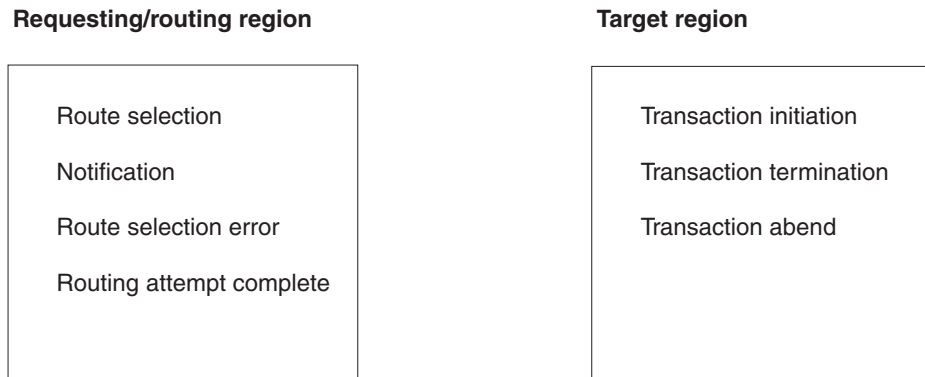

Figure 63. When and where the distributed routing program is invoked

## Changing the target CICS region

The DYRSYSID field of the communications area passed to the distributed routing program initially contains the system identifier (sysid) of the default target region to which the request is to be routed. This is derived from the value of the REMOTESYSTEM option of the installed transaction definition on the routing region. If REMOTESYSTEM is not specified, the sysid passed is that of the local CICS region.

When it is invoked for route selection, the distributed routing program can change the target region by changing the value in DYRSYSID.

If the specified sysid is invalid, or cannot be found, SYSIDERR is returned to the distributed routing program—which may deal with the error by returning a different sysid—see “If an error occurs in route selection” on page 640.

If the routing program changes the sysid when it is invoked for notification, routing complete, transaction initiation, transaction termination, or abend, the change has no effect.

## Telling CICS whether to route the request

When the routing program is invoked for routing, if you want the request to be routed (whether you have changed any values or not) return a zero value to CICS in field DYRRETC of the communications area. When you return control to CICS with return code zero, CICS first compares the returned sysid with its own local sysid:

- If the sysids are the same CICS executes the request locally.
- If the two sysids are not the same, CICS routes the request to the remote CICS region.

If you want CICS to reject the START request, return a non-zero value. The EXEC CICS START command receives a SYSIDERR condition, with a RESP2 value indicating that the START request has been rejected by the routing program.

Returning a value in DYRRETC has no effect when the routing program is invoked for notification, routing complete, transaction initiation, transaction termination, or abend.

## If an error occurs in route selection

If an error occurs in route selection—for example, if the sysid returned by the distributed routing program is unavailable or unknown—the routing program is invoked again. When this happens, you have a choice of actions:

1. You can try to route the request to a different target region, by changing the sysid, and issuing a return code of '0' in DYRRETC.

If this region too is unavailable, the routing program is again invoked for a route selection error. A count of the times the routing program has been invoked for routing purposes for this request is passed in field DYRCOUNT. Use this count to help you decide when to stop trying to route the request.

2. You can tell CICS not to continue trying to route the request, by issuing a non-zero return code in DYRRETC.

## Using the XICERES exit to check the availability of resources on the target region

You can use an XICERES global user exit program to check that all resources required by the started transaction are available on the target region.

To use the XICERES exit, both the routing region and the target region must support the “resource unavailable” condition (RESUNAVAIL). All the following support the “resource unavailable” condition:

- CICS TS OS/390, Version 1.3, with APAR PQ73107 applied
- CICS TS for z/OS, Version 2.2, with APAR PQ74920 applied
- CICS TS for z/OS, Version 2.3 and later

The XICERES exit is invoked, if enabled, on the target region before CICS processes a dynamically-routed START request.

If, for example, the transaction to be started is disabled on the target region, or a required file is missing, your exit program can give the distributed routing program the opportunity to route the request to a different region. To do this, it should set a return code of UERCRESU. This causes CICS to:

1. Return a RESUNAVAIL condition on the EXEC CICS START command executed by the mirror on the target region. (This condition is *not* returned to the application program.)
2. Set the DYRERROR field of the routing program's communications area to 'F'—resource unavailable.
3. Reinvoke the routing program, on the routing region, for route selection failure—see “If an error occurs in route selection.”

For information about writing an XICERES global user exit program, see The XICERES global user exit.

If a required resource is unavailable on the target region, but the XICERES exit is unavailable or disabled (or is enabled but does not set the UERCRESU return code), the client program receives an error response.

## Invoking the distributed routing program on the target region

The route selection, notification, route selection error, and routing complete invocations of the distributed routing program all occur on the routing region. If the routing program wants to be re-invoked *on the target region*, it must set the DYROPTER field in the communications area to 'Y'. It must do this on its initial (route selection or notification) invocation—and again, if it is reinvoked for a route selection error.

If the routing program sets DYROPTER to 'Y', it is re-invoked on the target region:

- When the transaction associated with the routed request is about to be initiated on the target region
- If the transaction terminates successfully
- If the transaction abends.

*This is effective only if the target region is CICS TS OS/390, Version 1.3 or later.*

Each time it is invoked on the target region, the routing program could update a count of transactions that are currently running on that region. When it is invoked for routing, the routing program could use the counts maintained by all the regions in the routing set (including itself) as input to its routing decision. This requires that each region in the routing set has access to a common data set on which the counts are recorded.

---

## Routing inbound Web service requests

You can use a distributed routing program to dynamically route inbound Web service requests.

### Which requests can be dynamically routed?

The target application program is eligible for workload management when one of the following is true:

- The target program is defined as DYNAMIC
- A program in the pipeline has changed the contents of container DFHWS-USERID from its initial value
- A program in the pipeline has changed the contents of container DFHWS-TRANID from its initial value.

In addition, routing will only take place if the TRANSACTION definition for the transaction named in DFHWS-TRANID specifies one of the following sets of attributes:

#### **DYNAMIC(YES)**

The transaction is routed using the distributed routing model, in which the routing program is specified in the DSRTPGM system initialization parameter.

#### **DYNAMIC(NO) and REMOTESYSTEM(*sysid*)**

The transaction is routed to the system identified by *sysid*.

If the request is fully eligible for dynamic routing, the distributed routing program is invoked for routing.

“Daisy-chaining” is not supported. That is, once a request has been dynamically routed to a target region it cannot be dynamically routed from the target to a third

region, even though the transaction is defined as ROUTABLE(YES) and DYNAMIC(YES). The transaction may, however, be statically routed from the target region to a third region.

## When the distributed routing program is invoked

For inbound Web service requests that are eligible for enhanced routing, CICS invokes the distributed routing program at the following points:

### On the routing region:

1. Either of the following:
  - For routing the request.
  - For notification of a statically-routed request. This occurs when the transaction definition specifies DYNAMIC(NO).  
The routing program is not able to route the request. It could, however, do other things.
2. If an error occurs in route selection—for example, if the target region returned by the routing program on the route selection call is unavailable. This gives the routing program the opportunity to specify an alternate target. This process iterates until the routing program selects a target that is available or sets a non-zero return code.
3. After CICS has tried (successfully or unsuccessfully) to route the request to the target region.  
This invocation signals that (unless the routing region and the target region are one and the same) the routing region's responsibility for this transaction has been discharged. The routing program might, for example, use this invocation to release any resources that it has acquired on behalf of the transaction.

### On the target region:

*These invocations occur only if the target region is CICS TS for z/OS Version 3.1 or later and the routing program on the routing region has specified that it should be reinvoked on the target region:*

1. When the transaction associated with the request starts on the target region.
2. If the transaction ends successfully.
3. If the transaction abends.

Figure 64 on page 643 shows the points at which the distributed routing program is invoked, and the region on which each invocation occurs. Note that the “target region” is not necessarily remote—it could be the local (routing) region, if the routing program chooses to execute the request locally.



### Requesting/routing region

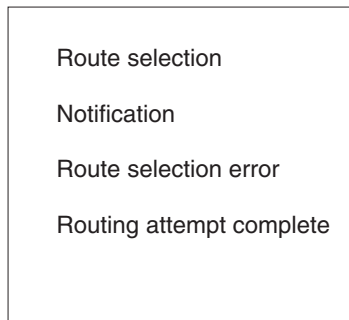

### Target region

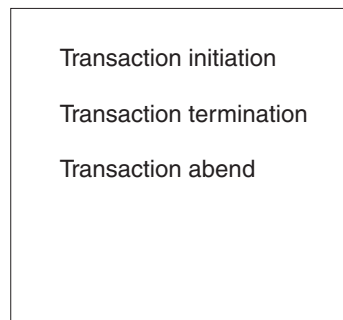

Figure 64. When and where the distributed routing program is invoked

## Changing the target CICS region

The DYRSYSID field of the communications area passed to the distributed routing program initially contains the system identifier (sysid) of the default target region to which the request is to be routed. This is derived from the value of the REMOTESYSTEM option of the installed transaction definition on the routing region. If REMOTESYSTEM is not specified, the sysid passed is that of the local CICS region.

When it is invoked for route selection, the distributed routing program can change the target region by changing the value in DYRSYSID.

If the specified sysid is invalid, or cannot be found, SYSIDERR is returned to the distributed routing program—which may deal with the error by returning a different sysid—see “If an error occurs in route selection” on page 644.

If the routing program changes the sysid when it is invoked for notification, routing complete, transaction initiation, transaction termination, or abend, the change has no effect.

## Telling CICS whether to route the request

When the routing program is invoked for routing, if you want the request to be routed (whether you have changed any values or not) return a zero value to CICS in field DYRRETC of the communications area. When you return control to CICS with return code zero, CICS first compares the returned sysid with its own local sysid:

- If the sysids are the same CICS executes the request locally.
- If the two sysids are not the same, CICS routes the request to the remote CICS region.

If you want CICS to reject the request, return a non-zero value.

Returning a value in DYRRETC has no effect when the routing program is invoked for notification, routing complete, transaction initiation, transaction termination, or abend.

## If an error occurs in route selection

If an error occurs in route selection—for example, if the sysid returned by the distributed routing program is unavailable or unknown—the routing program is invoked again. When this happens, you have a choice of actions:

1. You can try to route the request to a different target region, by changing the sysid, and issuing a return code of '0' in DYRRETC.

If this region too is unavailable, the routing program is again invoked for a route selection error. A count of the times the routing program has been invoked for routing purposes for this request is passed in field DYRCOUNT. Use this count to help you decide when to stop trying to route the request.

2. You can tell CICS not to continue trying to route the request, by issuing a non-zero return code in DYRRETC.

## Invoking the distributed routing program on the target region

The route selection, notification, route selection error, and routing complete invocations of the distributed routing program all occur on the routing region. If the routing program wants to be re-invoked *on the target region*, it must set the DYROPTER field in the communications area to 'Y'. It must do this on its initial (route selection or notification) invocation—and again, if it is reinvoked for a route selection error.

If the routing program sets DYROPTER to 'Y', it is re-invoked on the target region:

- When the transaction associated with the routed request is about to be initiated on the target region
- If the transaction terminates successfully
- If the transaction abends.

*This is effective only if the target region is CICS TS OS/390, Version 1.3 or later.*

Each time it is invoked on the target region, the routing program could update a count of transactions that are currently running on that region. When it is invoked for routing, the routing program could use the counts maintained by all the regions in the routing set (including itself) as input to its routing decision. This requires that each region in the routing set has access to a common data set on which the counts are recorded.

---

## Routing by user ID

Optionally, your routing program can route requests based on the CICS user ID (userid) associated with the request. The DYRUSERID field of the communications area contains the userid. When it is invoked for routing or because of a route-selection error, your routing program can base its routing decision on the contents of this field. For details of how the userid is set for different types of request, see the description of the DYRUSERID field in “Parameters passed to the distributed routing program” on page 645.

---

## Dealing with an abend on the target region

If a routed request fails on the target region, CICS invokes the routing program for transaction abend, returning the abend code in field DYRABCDE of the communications area. Note that this invocation occurs on the *target* region, and then only if the routing program has specified, on a previous call on the routing region, that it should be reinvoked on the target region.

The recommended way of dealing with an abend on the target region is as follows:

1. Code your routing program so that, on each route selection (and route selection error) call, it specifies that it is to be reinvoked (for transaction initiation, termination, and abend) on the target region—see “Invoking the distributed routing program on the target region” on page 634.
2. If the routing program is invoked, on the target region, for transaction abend, it conveys full details of the failed request to the routing region. It could, for example, write the communications area to a shared resource, such as an RLS file or a shared data table.
3. The routing program on the routing region checks the shared resource at predetermined intervals.
4. When the routing program on the routing region discovers that a routed request has failed, it checks the abend code in field DYRABCDE of the saved communications area. If the abend code indicates that the failure was due to anything *other* than a disabled CorbaServer, the routing program:
  - a. Removes the target region from its routing set.
  - b. Retries the request on another region. It tries repeatedly until either the request is successful or all possible AORs have been tried unsuccessfully. In the latter case, it returns an error response to the client.

If the abend code indicates that the failure was due to a disabled CorbaServer, special considerations apply. See “Dealing with a disabled CorbaServer” on page 635.

---

## Some processing considerations

- When writing your routing program, you are likely to find the EXEC CICS INQUIRE CONNECTION and INQUIRE IRC commands particularly useful if you want to confirm that a link is available before routing a request. The EXEC CICS INQUIRE and SET commands are described in System commands, in the *CICS System Programming Reference* manual.
- Because the distributed routing program executes outside a unit of work environment, your program should not:
  - Alter any recoverable resources
  - Issue file control or temporary storage requests.
- If you want to keep information about how requests are routed, it must be done in the user routing program, perhaps by writing the information to a data set. Note that, because the routing program is distributed, all the CICS regions in the transaction routing set must have access to the data set.
- The distributed routing program can be RMODE ANY but must be AMODE 31.

---

## Parameters passed to the distributed routing program

Figure 65 on page 646 shows the communications area passed to the distributed routing program. The communications area is mapped by the copy book DFHDYPDS, which is in the appropriate CICS library for all the supported programming languages.

DYRFUNC	DS	CL1	Function code
DYRCOMP	DS	CL2	Component code
DYRFILL1	DS	CL1	Reserved
DYRERROR	DS	CL1	Route selection error code
DYROPTER	DS	CL1	Transaction termination option
DYRQUEUE	DS	CL1	Queue-the-request indicator
DYRFILL2	DS	CL1	Reserved
DYRRETC	DS	F	Return code
DYRSYSID	DS	CL4	Default/Selected sysid
DYRVER	DS	H	Version of the interface
DYRTYPE	DS	CL1	Type of routing request
DYRFILL3	DS	CL1	Reserved
DYRTRAN	DS	CL8	Default/Selected remote tranid
DYRCOUNT	DS	F	Number of invocations count
DYRBPNTN	DS	F	Address of input buffer
DYRBLGTH	DS	F	Length of input buffer
DYRRTPRI	DS	CL1	Pass priority to AOR?
DYRFILL4	DS	CL1	Reserved
DYRPRTY	DS	H	Dispatch priority passed to AOR
DYRNETNM	DS	CL8	Netname matching sysid
DYRLPROG	DS	CL8	Run this program if routed locally
DYRDTRXN	DS	CL1	DTRTRAN indicator
DYRDTRRJ	DS	CL1	DTRTRAN reject?
DYRFILL5	DS	CL2	Reserved
DYRSRCTK	DS	XL4	MVS WLM service and reporting class token
DYRABNLC	DS	XL4	Abnormal event code
DYRABCDE	DS	CL4	Transaction abend code
DYRCABP	DS	CL1	Continue abend processing?
DYRLEVEL	DS	CL1	Required CICS level of AOR
DYRFILL6	DS	CL2	Reserved
DYRACMAA	DS	F	Address of applications's commarea
DYRACMAL	DS	F	Length of application's commarea
DYRUAPTR	DS	F	Address of user area
* THE FOLLOWING 8 LINES APPLY ONLY TO BTS TRANSACTIONS			
DYRCBTS	DS	0CL176	
DYRPROCN	DS	CL36	BTS process name
DYRPROCT	DS	CL8	BTS process-type
DYRACTN	DS	CL16	BTS activity name
DYRACTID	DS	CL52	BTS activity ID
DYRPROCID	DS	CL52	BTS process ID
DYRACTCMP	DS	CL1	BTS activity completing?
DYRPROCCMP	DS	CL1	BTS process completing?
DYRFILL7	DS	CL2	Reserved
DYRUSERID	DS	CL8	CICS userid
DYRBRTK	DS	CL8	BRIDGE FACILITY TOKEN, for Link3270 requests only
DYRUSER	DS	CL1024	User area
DYRCHANL	DS	CL16	Channel name
* DYRUAREA DSECT			
*			
DYRUSERN	DS	CL1024	USER AREA

Figure 65. The communications area passed to a distributed routing program

## Important

The same communications area is passed to both the distributed routing program and the dynamic routing program. Some parameters are meaningful to one routing program but not to the other. Some parameter-values may be passed to one routing program but never to the other. The following list describes in detail only the parameters that are significant to the distributed routing program; parameter-values that are never passed to the distributed routing program are not listed. For example,

under the DYRTYPE parameter the value X'4' is not listed because it is never passed to the distributed routing program; it occurs only on a program-link-related call to the dynamic routing program.

If you use the same program as both a distributed routing program and a dynamic routing program, for descriptions of the parameters and values that are significant on dynamic routing calls refer to “Parameters passed to the dynamic routing program” on page 607.

#### **DYRABCDE**

is the abend code returned when the transaction associated with a routed request abends in the target region.

This field is significant when the distributed routing program is invoked for termination of a routed request. Any value other than blanks indicates that the transaction has abended in the target region (which, for the distributed routing program, is also the region in which the routing program is invoked).

For method requests for enterprise beans and CORBA stateless objects, an abend code of 'AIID' indicates that the target CorbaServer is disabled in the target region. For specific information about coding a routing program to handle a disabled CorbaServer, see “Dealing with a disabled CorbaServer” on page 635.

For general information about how to handle other types of abend, see “Dealing with an abend on the target region” on page 644.

#### **DYRABNLC**

is an abnormal event code, or null.

This field is significant when the distributed routing program is invoked for termination of a routed request. Any value other than null indicates that an abnormal event, *other than a transaction abend*, has occurred in the region to which the request was routed (which, for the distributed routing program, is also the region in which the routing program is invoked). Your routing program should not route further requests to the same region until the cause of the error has been investigated and rectified.

This field is intended for use by CICSplex System Manager. Currently, it is set only by DB2. For more information, see the *CICS DB2 Guide*.

#### **DYRACMAA**

is not used by the distributed routing program. On invocation, it is set to zeroes.

#### **DYRACMAL**

is not used by the distributed routing program. On invocation, it is set to zeroes.

#### **DYRACTCMP**

indicates whether or not the BTS activity is completing. (When a process is being routed, DYRACTCMP indicates whether the root activity is completing.)

This field applies only to the routing of BTS processes and activities. Its contents are significant on transaction termination calls.

The possible values are:

- Y** This is the final activation of the BTS activity.
- N** This is not the final activation of the BTS activity.

**DYRACTID**

is the CICS-assigned, 52-character activity identifier of the BTS activity being routed. (When a process is being routed, DYRACTID returns the identifier of the root activity.)

This field applies only to the routing of BTS processes and activities.

**DYRACTN**

is the name of the BTS activity being routed. (When a process is being routed, DYRACTN returns the name of the root activity that is, DFHROOT.)

This field applies only to the routing of BTS processes and activities.

**DYRBLGTH**

is not used by the distributed routing program. On invocation, it is set to zeroes.

**DYRBPNTR**

is not used by the distributed routing program. On invocation, it is set to zeroes.

**DYRCABP**

indicates whether or not you want CICS to continue standard abend processing.

This field is not used by the distributed routing program. On invocation, it is set to 'Y'.

**DYRCHANL**

is the name of the channel, if any, associated with the program-link or START command. This field applies only to the routing of DPL requests, non-terminal-related START requests, and transactions started by terminal-related START requests. For other types of request, or if there is no channel associated with the command, this field contains blanks.

Note that the routing program is given the *name* of the channel, not its address, and so is unable to inspect or change the contents of the containers.

**DYRCOMP**

is the CICS component code. For calls to the distributed routing program, it is set to one of the following:

**SH** Scheduler services domain. For routing of BTS processes and activities, and non-terminal-related START requests.

**RZ** Request streams domain. For routing of method requests for enterprise beans and CORBA stateless objects, and inbound Web service requests.

**DYRCOUNT**

is a count of the times the distributed routing program has been invoked for this request with DYRFUNC set to 0, 1, or 3. This field allows you to limit the number of times your program tries to route a request.

**DYRDTRRJ**

indicates whether the transaction, which is defined by the common transaction definition specified on the DTRTRAN system initialization parameter, is to be rejected, or accepted for processing.

This field is not used by the distributed routing program. On invocation, it is set to 'N'.

**DYRDTRXN**

indicates whether the transaction to be routed is defined by the common transaction definition specified on the DTRTRAN system initialization parameter, or by a specific transaction definition.

This field is not used by the distributed routing program. On invocation, it is set to 'N'.

#### DYRERROR

has a value only when DYRFUNC is set to 1. It indicates the type of error that occurred during the last attempt at route selection. The possible values are:

- 0** The selected sysid is unknown.
- 1** The selected system is not in service.
- 2** The selected system is in service, but no sessions are available.
- 3** An allocate request has been rejected, and SYSIDERR returned to the application program. This error occurs for one of the following reasons:
  - 1. An XZIQUE global user exit program requested that the allocate be rejected, or
  - 2. CICS rejected the allocate request automatically because the QUEUELIMIT value specified on the CONNECTION resource definition has been reached.
- 4** A queue of allocate requests has been purged, and SYSIDERR returned to all the waiting application programs. This error occurs for one of the following reasons:
  - 1. An XZIQUE global user exit program requested that the queue be purged, or
  - 2. CICS purged the queue automatically because the MAXQTIME limit specified on the CONNECTION resource definition has been reached.
- 5** The selected system does not support this function.

For BTS processes and activities and non-terminal-related START requests, this error occurs if the distributed routing program tries to route a request to a region that is not connected by an MRO or APPC parallel-session link.

For method requests for enterprise beans and CORBA stateless objects, this error occurs if the distributed routing program tries to route a request to a region that is not connected by an MRO link.

For inbound Web services requests, this error occurs if the distributed routing program tries to route a request to a pre-CICS TS for z/OS, Version 3.1 region.

The next six values all apply to attempts to route START requests. For the meanings of these error conditions, see the *CICS Application Programming Reference* manual.

- 6** The EXEC CICS START command returned LENGERR.
- 8** The EXEC CICS START command returned INVREQ.
- 9** The EXEC CICS START command returned NOTAUTH.
- C** The EXEC CICS START command returned TRANSIDERR.
- D** The EXEC CICS START command returned IOERR.
- E** The EXEC CICS START command returned USERIDERR.
- F** An XPCERES or XICERES global user exit program on the target region has set a return code of UERCRESU, meaning that a required

resource is unavailable on the target region. This error code may be set for program-link, Link3270 bridge, and non-terminal-related START requests.

#### DYRFUNC

tells you the reason for this invocation of the distributed routing program. The possible values are:

- 0** Invoked for route selection.  
This invocation occurs on the routing region.
- 1** Invoked because an error occurred in route selection.  
This invocation occurs on the routing region.
- 2** Invoked because the transaction associated with a previously routed request has terminated successfully.  
This invocation occurs on the target region.
- 3** Invoked for notification of the destination of a statically-routed request.  
This invocation occurs on the routing region. It applies in the following cases:

##### **BTS processes and activities**

A RUN ASYNCHRONOUS command has been issued, but the transaction associated with the BTS process or activity is defined as DYNAMIC(NO).

##### **Enterprise beans and CORBA stateless objects**

A method request for an enterprise bean or CORBA stateless object has been issued, and the method is to run under a new OTS transaction or under no OTS transaction, but the transaction associated with the method request that is, the transaction specified on the REQUESTMODEL definition is defined as DYNAMIC(NO).

##### **Inbound Web service requests**

The transaction associated with the request is defined as DYNAMIC(NO).

##### **Non-terminal-related START requests**

A transaction defined as ROUTABLE(YES) is eligible for *enhanced* routing but not for *dynamic* routing because one or both of the following applies:

- The transaction definition specifies DYNAMIC(NO).
- The SYSID option of the START command names a remote region explicitly.

For detailed information about which non-terminal-related START requests are eligible for dynamic routing, see the *CICS Intercommunication Guide*.

- 4** Invoked because the transaction associated with the routed request abended.  
This invocation occurs on the target region.
- 5** Invoked for transaction initiation. The transaction associated with the routed request is about to be started on the target region.  
This invocation occurs on the target region.



- 6 Invoked because CICS has finished trying (successfully or unsuccessfully) to route the request to the target region.

This invocation occurs on the routing region. It signals that (unless the routing region and the target region are one and the same) the routing regions responsibility for this transaction has been discharged. The routing program might, for example, use this invocation to release any resources that it has acquired on behalf of the transaction.

The DYRTYPE field tells you the type of routing or notification request.

#### DYRLEVEL

is the level of CICS required in the target AOR to successfully process the routed request. The possible values are:

**X'00'** Any currently-supported version of CICS is able to process the request.

**X'01'** CICS TS for z/OS, Version 2.2. This value may be set only for method requests for enterprise beans and CORBA stateless objects.

**X'02'** CICS TS for z/OS, Version 2.3. This value may be set only for method requests for enterprise beans and CORBA stateless objects.

**X'03'** CICS TS for z/OS, Version 3.1. This value may be set for:

- DPL requests that have a channel associated with them.

**Note:** The routing of DPL requests is handled by the *dynamic* routing program.

- START requests that have a channel associated with them.
- Inbound web services requests.
- Method requests for enterprise beans and CORBA stateless objects.

**X'04'** CICS TS for z/OS, Version 3.2.

Note that values greater than X'00' indicate the specific, not the minimum, level of CICS required to process the request successfully.

This parameter is a migration aid, intended to help you perform a rolling upgrade of a multi-region logical server, whereby one region at a time is upgraded from one release of CICS to the next, without bringing down the server. Requests that require a specific level of CICS can be routed to an appropriate AOR.

#### Note:

1. This mixed level of operation, in which different CICS regions in the same logical server are at different levels of CICS, is intended to be used only for rolling upgrades. It should not be used permanently, because it increases the risk of failure in some interoperability scenarios. The normal, recommended, mode of operation is that all the regions in a logical sever should be at the same level of CICS and Java.
2. Do not attempt to use the DYRLEVEL field until you have read the definitive information about upgrading CICS EJB/CORBA servers in the *Java Applications in CICS*.

#### DYRLPROG

is not used by the distributed routing program. On invocation, it is set to null characters.

**DYRNETM**

is not used by the distributed routing program. On invocation, it is set to null characters.

**Note:** To set the target region, the distributed routing program must use the DYRSYSID field.

**DYROPTER**

specifies whether the distributed routing program is to be reinvoked on the target region when the transaction associated with the routed request:

1. Is to be started on the target region
2. Terminates (successfully or unsuccessfully).

This field is for use on route selection, notification, and route selection error calls. The possible values are:

- N** The distributed routing program is not to be invoked for transaction initiation, termination or abend that is, it is *not to be invoked on the target region*. This is the default.
- Y** The distributed routing program is to be reinvoked on the target region.
- For BTS processes and activities, this is effective only if the target region is CICS TS OS/390, Version 1.3 or later.
- For inbound Web services requests, this is effective only if the target region is CICS TS for z/OS, Version 3.1 or later.
- For non-terminal-related START requests, this is effective only if the target region is CICS TS OS/390, Version 1.3 or later. If the target region is an earlier CICS release, and you specify 'Y' for DYROPTER, the request will fail on the target region.
- For method requests for enterprise beans and CORBA stateless objects, this is effective only if the target region is CICS TS for z/OS, Version 2.1 or later.

You can specify this option for requests that are routed to remote CICS regions and also for those that are executed locally.

**DYRPROCCMP**

indicates whether or not the BTS process is completing.

This field applies only to the routing of BTS processes and activities. Its contents are significant on transaction termination calls.

The possible values are:

- Y** This is the final activation of the BTS process.
- N** This is not the final activation of the BTS process.

When it is invoked at transaction termination, the routing program could use the value of this field to decide whether to end any transaction affinities.

**DYRPROCID**

is the CICS-assigned, 52-character identifier of the BTS process to which the activity being routed belongs.

This field applies only to the routing of BTS processes and activities.

**DYRPROCN**

is the name of the BTS process to which the activity being routed belongs.

This field applies only to the routing of BTS processes and activities.

**DYRPROCT**

is the process-type of the BTS process to which the process or activity being routed belongs.

This field applies only to the routing of BTS processes and activities.

**DYRPRTY**

is not used by the distributed routing program. On invocation, it is set to zeroes.

**DYRQUEUE**

identifies whether or not the request is to be queued if no sessions are immediately available to the remote system identified by DYRSYSID.

This field is not used by the distributed routing program. On invocation, it is set to 'Y'.

**DYRRETC**

contains a return code that tells CICS how to proceed. The possible values are:

**0**      Route the request.

**Non-zero**

Do not route the request. CICS treats requests for BTS processes and activities as unserviceable (see the description of unserviceable requests in “If an error occurs in route selection” on page 628). START requests receive the SYSIDERR condition. Method requests for enterprise beans and CORBA stateless objects receive an exception.

Whenever the routing program is invoked, DYRRETC is set to 0. When it is invoked for route selection or because an error occurs in route selection, if you want CICS to route the request to the region specified in the DYRSYSID field, you must leave it set to 0.

You do not need to set a return code when the routing program is invoked for notification, routing complete, transaction initiation, transaction termination, or abend. (Any code you set is ignored by CICS.)

**DYRRTPRI**

indicates whether or not the dispatch priority of the transaction should be passed to the application-owning region, if the connection between the terminal-owning region and the application-owning region is MRO.

This field is not used by the distributed routing program. On invocation, it is set to 'N'.

**DYRSRCTK**

is the MVS workload management service and reporting class token for the routed transaction. Your routing program should not alter this value, which is set by CICS and used by CICSplex SM.

**Note:** For non-terminal-related START requests, this field is set to zeroes. Do not change it.

**DYRSYSID**

is the system identifier (sysid) of a CICS region. The exact meaning of this parameter depends on the value of DYRFUNC:

- When DYRFUNC is set to 0 (route selection), DYRSYSID contains:
  - The CICS region name specified on the REMOTESYSTEM option of the installed transaction definition, or,
  - If REMOTESYSTEM is not specified, the system name of the local CICS region.

The distributed routing program can accept the value of DYRSYSID or change it before returning to CICS.

If the sysid you return to CICS is the same as the local sysid, CICS executes the request on the local region.

- When DYRFUNC is set to 1 (route selection error), DYRSYSID contains the CICS region name returned to CICS by the distributed routing program on its previous invocation. If you want CICS to retry routing, you must change DYRSYSID before returning to CICS.
- When DYRFUNC is set to 2 (termination of a routed request), DYRSYSID contains the name of the target region on which the completed transaction executed. (This is also the region on which the distributed routing program is invoked.)
- When DYRFUNC is set to 3 (notification):
  - For **BTS processes and activities**, DYRSYSID contains:
    - The CICS region name specified on the REMOTESYSTEM option of the installed transaction definition, or,
    - If REMOTESYSTEM is not specified, the system name of the local CICS region.
  - For **inbound Web service requests**, DYRSYSID contains:
    - The CICS region name specified on the REMOTESYSTEM option of the installed transaction definition (for the transaction named in the DFHWS-TRANID container); or,
    - If REMOTESYSTEM is not specified, the system name of the local CICS region.
  - For **enterprise beans and CORBA stateless objects**, DYRSYSID contains:
    - The CICS region name specified on the REMOTESYSTEM option of the installed transaction definition (for the transaction specified on the REQUESTMODEL definition); or,
    - If REMOTESYSTEM is not specified, the system name of the local CICS region.
  - For **non-terminal-related START requests**, DYRSYSID contains:
    - The remote CICS region name specified on the SYSID option of the EXEC CICS START command, or
    - If SYSID is not specified, the remote CICS region name specified on the REMOTESYSTEM option of the installed transaction definition, or
    - If REMOTESYSTEM is not specified, the system name of the local CICS region.

Any change to the value of DYRSYSID is ignored.

- When DYRFUNC is set to 4 (transaction abend), DYRSYSID contains the name of the target region on which the transaction abended. (This is also the region on which the distributed routing program is invoked.)
- When DYRFUNC is set to 5 (transaction initiation), DYRSYSID contains the name of the target region on which the routed request is to be executed. (This is also the region on which the distributed routing program is invoked.)
- When DYRFUNC is set to 6 (routing completed), DYRSYSID contains the name of the target region to which CICS tried (successfully or unsuccessfully) to route the request.

#### **DYRTRAN**

contains the transaction name.

Note that this is *the name by which the transaction is known in the routing region*. Unlike the dynamic routing program, the distributed routing program:

1. Is passed the local, not the remote, transaction name
2. Cannot specify an alternative remote transaction name, for forwarding to the target region.

#### DYRTYPE

is the type of routing request for which the program is being invoked. The values that can be passed to the *distributed* routing program are:

- 5** A BTS process or activity.
- 6** A non-terminal-related START request, with or without data but with no channel.
- 7** A method request for an enterprise bean or CORBA stateless object, or an inbound Web services request.
- B** A non-terminal-related START request, with a channel.

#### DYRUAPTR

If DYRVER is '7' or greater, this field contains the address of the new user area (DYRUSERN). The new user area mechanism makes the source of the routing program independent of the CICS release that created the communications area. The old user area field DYRUSER is retained only for compatibility purposes.

The user area can be mapped with the DYRUAREA DSECT.

To ensure that DYRVER is '7' or greater, you must apply the PTFs for the following APARs to any of your routing or target regions at the specified CICS release:

**CICS Transaction Server for z/OS Version 2 Release 3**  
PQ81378

In systems where DYRUAPTR is less than '7' the contents of DYRUAPTR are unpredictable.

#### DYRUSER

is a 1024-byte user area.

**This field is retained only for compatibility purposes see the descriptions of the DYRUAPTR and DYRUSERN fields.**

#### DYRUSERID

is the CICS userid associated with the request.

- For **BTS processes and activities**, DYRUSERID contains:
  - If the BTS process or activity was activated by a LINK ACQPROCESS or LINK ACTIVITY command, the userid of the transaction that issued the LINK, or
  - The userid specified on the USERID option of the DEFINE PROCESS or DEFINE ACTIVITY command, or
  - If USERID was not specified on the DEFINE command, the userid under which the transaction that issued the DEFINE command is running.

For further details of the user IDs associated with BTS processes and activities, see the *CICS Business Transaction Services* manual.

- For **enterprise beans and CORBA stateless objects**, and **inbound Web services requests**, DYRUSERID contains the userid associated with the request stream.

- For **non-terminal-related START requests**, DYRUSERID contains:
  - The userid specified on the USERID option of the EXEC CICS START command, or
  - If USERID is not specified, the userid under which the transaction that issued the START command is running.

By examining this field when it is invoked for routing or because of a route-selection error (DYRFUNC=0 or 1, respectively), your routing program can route requests based on the userid associated with the request.

#### DYRUSERN

is a 1024-byte user area.

CICS initializes this user area to zeroes before invoking the distributed routing program for a given task. This user area can be modified by the routing program; the modified area is passed to subsequent invocations of the routing program for the same request.

However, note that:

1. The user area passed to the routing program on its first call on the target region (transaction initiation) is a *copy* of the user area on the routing region. This means that any modifications to the user area made on the target region have no effect on the user area in the routing region. For example, a change to the user area made on the transaction initiation call has no effect on the user area passed to the routing complete call, even if the latter occurs after the transaction initiation call.
2. The user area passed to the first (transaction initiation) call on the target region is a copy of that returned by *the call on the routing region that caused the transaction initiation call to occur*. That is:
  - If there was no error in route selection, it is a copy of the user area returned by the route selection or notification call.
  - If there was a route selection error, it is a copy of the user area returned by the final route selection error call.
  - It is *never* a copy of the user area returned by the routing attempt complete call on the routing region, even if the latter occurs before the transaction initiation call on the target region.

#### DYRVER

is the version number of the dynamic routing interface. For CICS Transaction Server for z/OS, Version 3 Release 2, the number is 10.

---

## Naming your distributed routing program

The supplied, sample distributed routing program is named DFHDSRP. If you write your own version, you can name it differently.

After the system has been loaded, to find the name of the distributed routing program currently identified to CICS, use the **EXEC CICS INQUIRE SYSTEM** command. Field DSRTPROGRAM contains the name of the current program.

To change the current program:

- Use the **DSRTPGM** system initialization parameter. For information about how to do this, refer to the *CICS System Definition Guide*.
- Make the change online using the **EXEC CICS SET SYSTEM DSRTPROGRAM** command. For programming information about this command, refer to the *CICS System Programming Reference* manual.

**Note:** A sample definition is provided for DFHDSRP, but you must install a new resource definition for a customized distributed routing program.

---

## Distributed transaction routing sample programs

The CICS-supplied sample distributed routing program is named DFHDSRP. The corresponding copy book that defines the communications area is DFHDYPDS. There are assembler-language, COBOL, PL/I, and C source-level samples and copy books. The supplied programs and copy books, and the CICSTS32.CICS libraries in which they can be found, are summarized in Table 33.

*Table 33. Distributed routing programs and copy books*

Language	Member name	Library
Programs: Assembler COBOL PL/I C	DFHDSRP DFHDSRP DFHDSRP DFHDSRP	SDFHSAMP SDFHCOB SDFHPL1 SDFHC370
Copy books: Assembler COBOL PL/I C	DFHDYPDS DFHDYPDS DFHDYPDS DFHDYPDS	SDFHMAC SDFHCOB SDFHPL1 SDFHC370

You can write your own distributed routing program in COBOL, PL/I, C, or assembler language, and you can change the name of the program.

When invoked with DYRFUNC set to '0', the sample programs accept the sysid that is passed in field DYRSYSID of the communications area, and set DYRRET to '0' before returning to CICS. When invoked with DYRFUNC set to '2', '3', '5', or '6', they set a return code of '0'. When invoked with DYRFUNC set to '1' or '4', they set a return code of '8'.

If you want to route requests dynamically, you must customize DFHDSRP, or replace it completely with your own routing program.





---

## Chapter 19. Writing a CICS–DBCTL interface status program

### Considerations common to all user-replaceable programs

Note that the comments contained in Chapter 5, “General notes about user-replaceable programs,” on page 435 apply to this chapter.

The CICS–DBCTL interface status program DFHDBUEX is a user-replaceable program forming part of the support for the CICS–DBCTL interface. It is designed to invoke user-supplied code whenever CICS successfully connects to or disconnects from DBCTL. It runs in a CICS application environment and is driven at specific points to allow you to enable and disable your CICS-DL/I transactions when the CICS–DBCTL interface initializes or terminates.

DFHDBUEX is invoked in the following case for the ENABLE command:

- CICS has connected to DBCTL successfully. This occurs after a connection request has been issued from CICS to DBCTL. The control exit (DFHDBCTX) is invoked by the database resource adapter (DRA) for<sup>7</sup> ‘initialization complete’. The control exit posts the control transaction (CDBO). The control program (DFHDBCT) then invokes DFHDBUEX.

DFHDBUEX is invoked in the following cases for the DISABLE command:

- A request has been issued to disconnect from DBCTL. The CICS–DBCTL menu program (DFHDBME) starts the disconnection transaction (CDBT) to disconnect from DBCTL. The disconnection program (DFHDBDSC) invokes DFHDBUEX before issuing the interface termination request to the adapter.
- The control transaction (CDBO) has been notified of one of the following events:
  - A checkpoint freeze request to DBCTL
  - DRA abnormal termination
  - DBCTL abnormal termination.

In each of these cases, the control program (DFHDBCT) invokes DFHDBUEX.

Input to DFHDBUEX is by means of a communication area addressed by DFHEICAP. The layout of the communication area is shown in Figure 66.

DBUSHEAD	DS	OCL4	Standard Header	
DBUREQT	DS	CL1	Function Code	
DBUCOMP	DS	CL2	Component Code	Always "DB"
DBURESV	DS	CL1	Reserved	
DBUREAS	DS	CL1	Reason for disconnection	
DBUSUFF	DS	CL2	DRA startup table suffix	
DBUDBCTL	DS	CL4	DBCTL identifier	

Figure 66. The DFHDBUEX communication area

The parameter list contains the following information:

#### **DBUREQT**

Request Type. The function code has one of the following values:

#### **DBUCONN (X'01')**

Connected

---

7. The interface that enables DBCTL databases to be accessed from CICS.

**DBUDISC (X'02')**  
Disconnected.

**DBUREAS**

Reason for Disconnection. Contains flags:

**DBUMENU (X'01')**  
Disconnected from menu

**DBUDBCC (X'02')**  
Checkpoint Freeze input to DBCTL

**DBUDRAF (X'03')**  
DRA Failure has taken place

**DBUDBCF (X'04')**  
DBCTL Failure has taken place.

**DBUSUFF**

DRA startup table suffix.

**DBUDBCTL**

DBCTL identifier.

---

## The sample CICS–DBCTL interface status program

The source-code of the supplied CICS–DBCTL interface status program, DFHDBUEX, is provided, in assembler language only, in the CICSTS32.CICS.SDFHSAMP library. A corresponding copy book, DFHDBUCA, that maps the communication area, is in CICSTS32.CICS.SDFHMAC.

The sample program checks for the presence of the input parameters (passed in the communication area). If these do not exist, control returns to the calling program.

The type of request (CONNECTIONIDISCONNECTION) is then determined, and a branch is taken to the appropriate function routine (CONPROCIDISPROC).

The sample contains an example, as part of a comment, of how to enable and how to disable a transaction. To use the program, it is necessary for transactions using DBCTL to be defined in the CSD as DISABLED.

You can code your own CICS–DBCTL interface status program in any of the languages supported by CICS. For information about the job control statements necessary to assemble and link-edit user-replaceable programs, refer to “Assembling and link-editing user-replaceable programs” on page 436.

---

## Chapter 20. Writing a 3270 bridge exit program

### Considerations common to all user-replaceable programs

Note that the comments contained in Chapter 5, “General notes about user-replaceable programs,” on page 435 apply to this chapter.

The 3270 bridge provides an interface so that you can run 3270-based CICS transactions without a 3270 terminal. In the bridge environment, terminal commands are intercepted by CICS and passed to a bridge exit user-replaceable program.

The bridge exit provides the mechanism by which data needed to run a 3270 transaction can be sent and received from an external resource. For example, you can use WebSphere® MQ commands in a bridge exit so that CICS can GET and PUT messages to WebSphere MQ queues.

For a detailed description of the 3270 bridge exit and its interfaces, see Bridging to 3270 transactions, in the *CICS External Interfaces Guide*.



---

## Chapter 21. Writing a security exit program for IIOp

### Considerations common to all user-replaceable programs

Note that the comments contained in Chapter 5, “General notes about user-replaceable programs,” on page 435 apply to this chapter.

Incoming requests using the Internet Inter-ORB Protocol (IIOp) are processed by CICS under a default user ID, unless you provide an IIOp security exit program to assign a new user ID. The security exit program can use CICS services, such as a task-related user exit program to access DB2, and application parameters encoded within the body of the request.

You can define the name of the security program on the URM option of the TCPIP SERVICE resource definition for the IIOp port. If no name is specified, or if the AUTHENTICATE option is defined as CERTIFICATE, the security exit program will not be called. Two sample security exit programs, DFHXOPUS and DFHEBURM, are supplied.

The IIOp security program is passed a COMMAREA with the following format. If a field does not exist, its pointer and length are zeroes:

Offset Hex	Type	Len	Name
(0)	STRUCTURE	80	sXOPUS
(0)	CHARACTER	4	standard_header
(4)	FULLWORD	4	pIIOpData
(8)	FULLWORD	4	IIIOpData
(C)	FULLWORD	4	pRequestBody
(10)	FULLWORD	4	IRequestBody
(14)	CHARACTER	4	corbaserver
(18)	FULLWORD	4	pBeanName
(1C)	FULLWORD	4	IBeanName
(20)	FULLWORD	4	BeanInterfaceType
(24)	FULLWORD	4	pModule
(28)	FULLWORD	4	IModule
(2C)	FULLWORD	4	pInterface
(30)	FULLWORD	4	IInterface
(34)	FULLWORD	4	pOperation
(38)	FULLWORD	4	IOperation
(3C)	CHARACTER	8	userid
(44)	FULLWORD	4	transid
(48)	FULLWORD	4	flag_bytes
(4C)	FULLWORD	4	return_code
(50)	FULLWORD	4	reason_code

Where:

**standard\_header**

contains a standard header with the following format:

**function**

1-character function code

**domain**

2-character field containing “II”

\* 1-character reserved field

**pIIOPData**

contains the address of the first megabyte of the unconverted IIOp buffer. If the incoming request is fragmented, this field contains a pointer to:

- the first megabyte of the first fragment, if the first fragment is greater than 32K
- a 32K buffer containing data from the first fragments that fit in the buffer, if the first fragment is less than or equal to 32K.

**lIIOPData**

contains the length of the unconverted IIOp buffer.

**pRequestbody**

contains the address of the incoming IIOp request.

**lRequestbody**

contains the length of the incoming IIOp request.

**corbaserver**

contains the name of the CorbaServer associated with this request.

**pBeanName**

contains a pointer to the EBCDIC bean name.

**lBeanName**

contains the length of the bean name.

**BeanInterfaceType**

contains an enumerated value. X'00' indicates home; X'01' indicates remote.

**pModule**

contains a pointer to the EBCDIC Module name.

**lModule**

contains the length of the Module name.

**pInterface**

contains a pointer to the EBCDIC Interface name.

**lInterface**

contains the length of the Interface name.

**pOperation**

contains a pointer to the EBCDIC Operation name.

**lOperation**

contains the length of the Operation.

**userid**

contains the input and output user ID. The output user ID must be exactly 8 characters long. If it is shorter than 8 characters it must be padded with blanks.

**transid**

contains the input TRANSID.

**Flag\_bytes**

contains the following indicators:

**littleEndian**

1-byte field showing byte-order, where **1** indicates TRUE and **0** indicates FALSE.

**sslClientUserid**

1-byte field showing the derivation of the user ID if SSLTYPE CLIENTAUTH is specified in the TCPIPSERVICE definition, where:

- 0 user ID set from DFLTUSER
- 1 user ID set from SSL CERTIFICATE

\* 2-byte reserved field

**return\_code**

contains the return code.

**reason\_code**

contains the reason code.

A user ID can be returned, but other fields are provided for information only.

For further information about the use of the IIOp security user-replaceable program, see Using the IIOp user-replaceable security program, in the *Java Applications in CICS*.

---

## The sample programs

CICS supplies two sample security exit programs for IIOp—DFHXOPUS and DFHEBURM. Both are in the SDFHSAMP library.

For further information about the use of the Secure Sockets Layer (SSL), see the *CICS RACF Security Guide*.

## DFHXOPUS

DFHXOPUS attempts to derive a user ID by examining the Secure Sockets Layer (SSL) options defined for the TCPIPSERVICE.

DFHXOPUS accepts the RACF user ID associated with the SSL client certificate, if there is one associated with the TCPIPSERVICE. If there is no RACF user ID associated with a certificate:

- For SSL(CLIENTAUTH), DFHXOPUS uses the first eight characters of the COMMONNAME extracted from the client certificate.
- For SSL(YES) or SSL(NO), DFHXOPUS uses the first eight characters of the IIOp Principal, if there is one.

**Note:** Versions of the General Inter-ORB Protocol (GIOP) from 1.2 onwards do not support the IIOp Principal field in request headers. So DFHXOPUS will only ever return a user ID derived from the IIOp Principal when the request is in GIOP 1.1, or earlier, format.

If a user ID has not been found using these procedures, DFHXOPUS returns the default user ID defined by the CICS system initialization DFLTUSER parameter.

The security exit program returns the user ID in the userid field of the communications area. If the user ID is less than 8 characters long, the exit program pads the field with blanks. Because a user ID is being returned, the return\_code field is set to RCUSRID (X'01') .

If you write your own security exit program, it should return all fields other than `userid` and `return_code` unchanged, or unpredictable results will occur.

## **DFHEBURM**

DFHEBURM is for use with the EJB Bank Account sample program. It alters the user ID under which the sample runs from the default CICS user ID to "SAMPLE". For more information about DFHEBURM, see The EJB Bank Account sample application, in the *Java Applications in CICS*.



---

## Chapter 22. Writing programs to customize JVMs

This chapter describes how to write programs to customize a Java Virtual Machine (JVM). The normal way to customize JVMs is by specifying options in the JVM profile, and system properties in the JVM properties file. There are three additional ways to customize JVMs:

- You can create Java classes that intercept the stdout and stderr output from a JVM, add time stamps and record headers, and redirect the output to the destination of your choice. “Writing Java classes to redirect JVM stdout and stderr output” tells you how to do this.
- You can define Language Environment runtime options for the Language Environment enclave in which a JVM runs, by using the DFHJVMRO user-replaceable program. You should only need to do this in exceptional circumstances. “Using DFHJVMRO to modify the Language Environment enclave for a JVM” on page 670 tells you how to do this.
- You can override the options in a JVM profile by using a program, DFHJVMAT, that can be called when the JVM is launched. You can only call DFHJVMAT for a single-use JVM, that is, with a JVM profile that specifies REUSE=NO (for example, the supplied sample JVM profile DFHJVMPS). You should consider using DFHJVMAT only if you need to tailor a single-use JVM in a way that can't be achieved by specifying options in the JVM profile. “Using DFHJVMAT to modify options in a JVM profile” on page 671 tells you how to do this.

---

### Writing Java classes to redirect JVM stdout and stderr output

Use the USEROUTPUTCLASS option in a JVM profile to name a Java class that intercepts the stdout and stderr output from the JVM. You can tailor this class to specify your choice of time stamps and record headers, and to redirect the output.

CICS supplies sample Java classes, `com.ibm.cics.samples.SJMergedStream` and `com.ibm.cics.samples.SJTaskStream`, that you can use for this purpose. Sample source is provided for both these classes, in the directory `/usr/lpp/cicsts/cicsts32/samples/useroutputclass`. The `/usr/lpp/cicsts/cicsts32` directory is the install directory for CICS files on z/OS UNIX. This directory is specified by the USSDIR parameter in the DFHISTAR install job. The sample classes are also shipped as a class file, `dfjoutput.jar`, which is in the directory `/usr/lpp/cicsts/cicsts32/lib`. You can modify these classes, or write your own classes based on the samples.

Controlling the location for JVM stdout, stderr and dump output, in the *Java Applications in CICS* has information about:

- The types of output from JVMs that are and are not intercepted by the class named by the USEROUTPUTCLASS option. The class that you use must be able to deal with all the types of output that it might intercept.
- The behaviour of the supplied sample classes. The `com.ibm.cics.samples.SJMergedStream` class creates two merged log files for JVM output and for error messages, with a header on each record containing applid, date, time, transid, task number and program name. The log files are created using transient data queues, if they are available; or z/OS UNIX files, if the transient data queues are not available, or cannot be used by the Java application. The `com.ibm.cics.samples.SJTaskStream` class directs the output from a single task to z/OS UNIX files, adding time stamps and headers, to provide output streams that are specific to a single task.

For a JVM to use an output redirection class that you have modified or written, the class must be present in a directory on an appropriate class path in the JVM profile or properties file. The directory containing the jar file for the sample output redirection class is automatically included on an appropriate class path, and you do not need to specify it explicitly in the JVM profile. If you supply your own class, you need to add the directory to either the shareable application class path, or the standard class path. Only use the shareable application class path if you are using Java 1.4.2 with class sharing, otherwise use the standard class path. Adding application classes to the class paths for a JVM *Java Applications in CICS* explains how to do this.

If you decide to write your own classes, you need to know about:

- The `OutputRedirectionPlugin` interface
- Possible destinations for output
- Handling output redirection errors and internal errors

These considerations are described below.

## The `com.ibm.cics.server.OutputRedirectionPlugin` interface

CICS supplies an interface called `com.ibm.cics.server.OutputRedirectionPlugin`, shipped in `dfjcics.jar`, which can be implemented by classes that intercept the `stdout` and `stderr` output from the JVM. The CICS-supplied samples implement this interface. The sample classes themselves are made up of:

- A superclass `com.ibm.cics.samples.SJStream` that implements this interface
- The subclasses `com.ibm.cics.samples.SJMergedStream` and `com.ibm.cics.samples.SJTaskStream`, which are the classes that are actually named in the JVM profile.

It is recommended that, like the sample classes, your class implements the interface `OutputRedirectionPlugin` directly, or extends a class which itself implements the interface. You can achieve this either by inheriting from the superclass `com.ibm.cics.samples.SJStream`, or by implementing a class structure with the same interface. Whether or not your class implements the interface `OutputRedirectionPlugin`, it must extend `java.io.OutputStream`.

The `initRedirect()` method receives a set of parameters, which are used by the output redirection class or classes. The coding for the interface is as follows:

```
package com.ibm.cics.server;

import java.io.*;

public interface OutputRedirectionPlugin {

    public boolean initRedirect( String inDest,
                               PrintStream inPS,
                               String inApplid,
                               String inProgramName,
                               Integer inTaskNumber,
                               String inTransid
                               );

}
```

The superclass `com.ibm.cics.samples.SJStream` contains the common components of `com.ibm.cics.samples.SJMergedStream` and `com.ibm.cics.samples.SJTaskStream`. It contains an `initRedirect` method that returns 'false', which effectively disables output redirection unless this method is overridden

by one provided in a subclass. It does not implement a `writeRecord` method, and such a method must be provided by any subclass to control the output redirection process. You could imitate this in your own class structure. The initialization of output redirection can also be performed using a constructor, rather than the `initRedirect` method.

**Note:** The `inPS` parameter contains either the JVM's original `System.out` `PrintStream` or the JVM's original `System.err` `PrintStream`. You may log to either of these underlying logging destinations. You must not call the `close()` method on either of these `PrintStreams`, as they will remain closed permanently, and will not be available for use either during the execution of the current program, or in subsequent reuses of the same JVM.

## Possible destinations for output

The CICS-supplied sample classes direct output from JVMs to a directory that is specific to a CICS region. (The directory name is created using the `applid` associated with the CICS region.) When you write your own classes, if you prefer, you can send output from several CICS regions to the same z/OS UNIX directory or file. For example, you might want to create a single file containing the output associated with a particular application that runs in several different CICS regions.

Java applications executing on threads other than the initial process thread (IPT) are not able to make CICS requests. For these applications, the output from the JVM is intercepted by the class you have specified for `USEROUTPUTCLASS`, but it cannot be redirected using CICS facilities (such as transient data queues). You can direct output from these applications to z/OS UNIX files, as the supplied sample classes do. For Java applications that are executing on the IPT, you can use CICS facilities, such as transient data queues, to redirect the output.

## Handling output redirection errors and internal errors

If your classes use CICS facilities to redirect output, they should include appropriate exception handling to deal with errors in using these facilities. For example, if you are writing to the transient data queues `CSJO` and `CSJE`, and using the CICS-supplied definitions for these queues, the following exceptions might be thrown by `TDQ.writeData`:

- `IOException`
- `LengthErrorException`
- `NoSpaceException`
- `NotOpenException`

If your classes direct output to z/OS UNIX files, they should include appropriate exception handling to deal with errors that occur when writing to z/OS UNIX. The most common cause of these errors is a security exception.

The Java programs that will run in JVMs that name your classes on the `USEROUTPUTCLASS` options should include appropriate exception handling to deal with any exceptions that might be thrown by your classes. The CICS-supplied sample classes handle exceptions internally, by using a `Try/Catch` block to catch all throwable exceptions, and then writing one or more error messages to report the problem. When an error is detected while redirecting an output message, these error messages are written to `System.err`, making them available for redirection. However, if an error is found while redirecting an error message, then the messages which report this problem are written to the file indicated by the `STDERR` option in the JVM profile used by the JVM that is servicing the request. Because

the sample classes trap all errors in this way, this means that the calling programs do not need to handle any exceptions thrown by the output redirection class. You can use this method to avoid making changes to your calling programs. Be careful that you do not send the output redirection class into a loop by attempting to redirect the error message issued by the class to the destination which has failed.

---

## Using DFHJVMRO to modify the Language Environment enclave for a JVM

DFHJVMRO specifies the run-time options that are used to create the Language Environment enclave in which a JVM runs. It defines storage allocation parameters for heap and stack and a number of other options. For CICS, the storage settings that are supplied in DFHJVMRO are more efficient than the default Language Environment storage settings. Storage heaps in JVMs, in the *Java Applications in CICS* explains how the storage for a JVM is allocated within its Language Environment enclave.

You might want to change the supplied version of the program if you need to:

- Use the RPTO and RPTS options to obtain reports on the storage options set, and the actual storage used, for JVMs.
- Set storage heap values which are different from the CICS-supplied settings. Tuning Language Environment enclave storage for JVMsThe *CICS Performance Guide* tells you how to use reports obtained using the RPTO and RPTS options to identify suitable storage heap values.
- At the request of the IBM service team, set other options to obtain diagnosis information.

Note that the initial heap size and the heap increment sizes defined by DFHJVMRO are for minimal values, and less than the minimum heap size for a typical JVM. This is because the actual amount of storage allocated for the Java heap is controlled by the Xmx initialization option specified in a JVM profile.

Language Environment run-time options are provided for the JVM by the following mechanisms, of which you have control over the first two only:

1. The installation-defined defaults generated by the CEEDOPT macro.
2. The DFHJVMRO user-replaceable module.
3. The CICS JVM domain, which enforces certain options.

The DFHJVMRO user-replaceable-module:

- Is invoked during the CEEPIPI preinitialization phase of each Language Environment enclave that is created for a JVM
- Allows you to alter the default Language Environment run-time options
- Must be written in assembler language
- Must not be translated with the CICS translator

The *z/OS V1R7.0 Language Environment Programming Guide*, SA22-7561-06, has complete information about Language Environment run-time options. The options are specified as character strings, comprising a 2-byte string length followed by the run-time option. The maximum length allowed for all Language Environment run-time options is 255 bytes, so you are recommended to use the abbreviated version of each option, and restrict your changes to a total of under 200 bytes.

CICS checks the length of the runtime options before passing them to Language Environment. If the length is greater than 255 bytes, CICS does not attempt to start the JVM. Error messages are written to CSMT in this case. Note that the *values* you specify are not checked by CICS before being passed to Language Environment.

If you decide to modify DFHJVMRO, note the following:

- Keep the size of the list of options to a minimum for quick processing, and because CICS adds some options to this list.
- You can use the HEAP option (abbreviation H) to specify the initial HEAP allocation.
- The ALL31 option, the POSIX option (abbreviation POS) and the XPLINK option are forced on by CICS. The ABTERMENC option is set to (ABEND) and the TRAP option is set to (ON,NOSPIE) by CICS.

**Note:** POSIX is turned on for CICS internal processing. CICS does not support the POSIX interface for application use. If you use POSIX directly in your program, you do so at your own risk."

- The output produced by the RPTO and RPTS options is written to the CESE transient data queue.
- Be aware that any options that produce output (for example, RPTO or RPTS), do so at each JVM termination. Consider the volume of output that may be produced and directed to CESE.
- Although you can specify any valid Language Environment run-time options, you are recommended to specify only those used in the CICS-supplied source of DFHJVMRO.

See the fully-commented source code for DFHJVMRO for an example of how to set these options.

---

## Using DFHJVMAT to modify options in a JVM profile

DFHJVMAT is a user-replaceable program that you can use to override the options specified in a JVM profile. Normally, a JVM profile provides sufficient flexibility to configure a JVM as required. You should consider using DFHJVMAT only if you need to tailor the JVM in a way that cannot be achieved by specifying options in the JVM profile.

You can also use DFHJVMAT to override the JVMCLASS attribute on the CICS PROGRAM resource definition. This attribute specifies the main class in the Java program that is to execute in the JVM. If you use the PROGRAM resource definition, the limit for the JVMCLASS attribute is 255 characters, but you can use DFHJVMAT to specify a class name longer than 255 characters.

You can call DFHJVMAT by specifying INVOKE\_DFHJVMAT=YES as an option on the JVM profile that you want to override.

### Important

You can **only** call DFHJVMAT for a single-use JVM, that is, a JVM with a JVM profile that specifies the option REUSE=NO (for example, the supplied sample JVM profile DFHJVMPS). With single-use JVMs, when the task using the JVM terminates, CICS does not attempt to make the JVM available for reuse for another task.

You **cannot** call DFHJVMAT for a continuous JVM, that is, with a JVM profile that specifies REUSE=YES (for example, the default CICS-supplied JVM profile, DFHJVMPR). If you specify INVOKE\_DFHJVMAT=YES for this type of JVM, then INVOKE\_DFHJVMAT=YES is ignored and DFHJVMAT is not called.

The values specified in the JVM profile are available to DFHJVMAT as z/OS UNIX System Services environment variables, which you can modify before the JVM is created.

**Note:** The values of the STDERR and STDOUT parameters, which can be interpreted by CICS to generate task-specific names, are passed to DFHJVMAT before interpretation.

DFHJVMAT uses the C/C++ `getenv` and `setenv` functions to change the environment variables that correspond to the options in the JVM profile. For example, you could use the following command to replace the CLASSPATH\_SUFFIX environment variable with the specified value:

```
setenv(ecp_suffix, cp_suffix_val,1)
```

where:

```
char *ecp_suffix = "CLASSPATH_SUFFIX";  
char *cp_suffix_val = "/u/jtest1/Java/test:.";
```

Note that the `setenv` function has no effect on the CICS PROGRAM resource definition and remains in effect only for the lifetime of the JVM.

The CICS-supplied DFHJVMAT:

- Issues `getenv` requests for each variable.
- Issues a `printf` to destination `stdout`, to record the setting of each variable.
- Contains (within comments) some sample code that demonstrates how to use the `setenv` command—including how to append TASKnnnn (where 'nnnn' is the CICS task number) to the supplied names for **stdout** and **stderr**. This shows how to make unique output and error files for each CICS task.

If you write your own program to tailor options in the JVM profile based on the supplied version, the name must be DFHJVMAT, and the program must be written in C. You can use EXEC CICS commands within DFHJVMAT but you should be aware that this might incur a processing overhead. Note that DFHJVMAT must be written to threadsafe standards and defined with CONCURRENCY(THREADSAFE) in its program resource definition, because multiple invocations of this module might run in parallel.

## Options in the JVM profile that are available to DFHJVMAT

The JVM profile options listed in this topic are made available to DFHJVMAT. The options are read from the specified JVM profile and created as environment variables using Language Environment services.

In most cases, the full descriptions of these options are in the *CICS System Definition Guide*. Before modifying any of these options using DFHJVMAT, you should read the full description of the option. Some of the options are no longer documented in the CICS documentation, and information about these can be found in the documentation for the IBM SDK for z/OS, Java 2 Technology Edition and other Java documentation.

**Note:**

1. Except where explicitly stated as being for information only, you can reset the values of these variables.
2. All environment variables and values are case sensitive, and should be set as shown.
3. CICS ignores any values that it does not recognize as a valid option.
4. For the options beginning with X:
  - Some of these options are no longer documented in the CICS documentation. However, they are still valid options and available to DFHJVMAT.
  - These options should now begin with -X when specified in a JVM profile. However, the hyphen is not included in the environment variables used by DFHJVMAT, which still begin with X.

Table 34. JVM profile options available to DFHJVMAT

Option	Specifies
CICS_HOME	Home directory for CICS files on z/OS UNIX, including CICS-supplied JAR files
CLASSCACHE_MSGLOG	Log file on z/OS UNIX for messages from master JVM (with Version 1.4.2 of the SDK)
CLASSPATH_PREFIX, CLASSPATH_SUFFIX	Prefix and suffix to standard class path
INVOKE_DFHJVMAT	For information only
JAVA_DUMP_OPTS	Set of Java dump options to obtain diagnostics for an abend in the JVM
JAVA_HOME	Path to IBM SDK for z/OS, Java 2 Technology Edition subdirectories and JAR files
JVMPROPS	Path and name of the JVM properties file
LIBPATH_PREFIX, LIBPATH_SUFFIX	Prefix and suffix to library path
STDERR	Name of z/OS UNIX file for <b>stderr</b> output from the JVM
STDIN	Name of z/OS UNIX file for <b>stdin</b>
STDOUT	Name of z/OS UNIX file for <b>stdout</b> output from the JVM
USEROUTPUTCLASS	Name of a Java class that intercepts and redirects the <b>stdout</b> and <b>stderr</b> output from the JVM.
VERBOSE	Level of information messages from the JVM
WORK_DIR	Working directory for CICS region on z/OS UNIX
Xcheck	Perform additional checks
Xdebug	Enable debugging support
Xinitsh	Initial size of the system heap
Xmaxe, Xmaxf, Xmine, Xminf	Maximum and minimum heap expansion sizes and free heap percentage sizes for the nonsystem heap
Xms	Initial size of the nonsystem heap
Xmx	Maximum size of the nonsystem heap
Xnoagent	Disable the old sun.tools.debug agent (if Xdebug specified)
Xnoclassgc	Disable class garbage collection
Xoss	Maximum Java stack size for any thread

Table 34. JVM profile options available to DFHJVMAT (continued)

Option	Specifies
Xrs	Reduces the use of operating system signals by the JVM
Xrundllname	Loads the specified dynamic link library (DLL) and passes it the specified options
Xss	Size of stack for each new Java thread
Xverify	Level of verification to perform on classes loaded

Two additional fields not found in a standard JVM profile are passed to DFHJVMAT, as follows:

**CICS\_PROGRAM**

Specifies the name of the CICS program (1-8 characters) associated with the Java class to be run. This name is established at run-time; it is passed to DFHJVMAT for information only and cannot be changed. Any changes are ignored by CICS.

**CICS\_PROGRAM\_CLASS**

Specifies the CICS user application class name, and is obtained from the program resource definition. This is defined by the JVMCLASS attribute on the CICS PROGRAM resource definition. As an alternative to using DFHJVMAT to override this attribute, you can use EXEC CICS SET PROGRAM or CEMT SET PROGRAM commands to modify the JVMCLASS attribute on the PROGRAM resource definition before control is passed to the JVM. If you use the PROGRAM resource definition, the limit for the JVMCLASS attribute is 255 characters, but you can use DFHJVMAT to specify a class name longer than 255 characters.



---

## Chapter 23. Writing a distinguished name program for clients of enterprise beans

### Considerations common to all user-replaceable programs

Note that the comments contained in Chapter 5, “General notes about user-replaceable programs,” on page 435 apply to this chapter.

Use the distinguished name user-replaceable program, DFHEJDNX, to supply the distinguished name of a client of an enterprise bean, when the client has not presented an X.509 certificate containing a name.

DFHEJDNX is invoked when an IIOP client which doesn't have a secure sockets layer (SSL) X.509 certificate issues a **getname** call. DFHEJDNX returns a string representation of the distinguished name.

CICS supplies a sample version of DFHEJDNX, which you can use as the basis of your own customized program. Your customized program must also be called DFHEJDNX.

On invocation, CICS passes DFHEJDNX the following parameters in a communications area:

#### **ejdn\_parameter\_list\_length**

A binary halfword containing the length of this parameter list.

#### **ejdn\_parameter\_list\_eyecatcher**

A 14-byte character string containing an “eyecatcher” ('>DFHEJDNX\_PARM') to identify this parameter list in dumps and traces.

#### **ejdn\_parameter\_list\_version**

A binary halfword containing the version number of this parameter list. For CICS TS for z/OS, Version 3.2, the version number is zero.

#### **ejdn\_parameter\_list\_flags**

A binary halfword reserved for indicator flags. Currently, no indicator flags are defined.

#### **ejdn\_distinguished\_name\_ptr**

A pointer to a 512-character work area in which DFHEJDNX can build the distinguished name to be assigned to the client.

The distinguished name returned by DFHEJDNX must be an EBCDIC null-delimited character string in the format proposed by RFC 2253, *Lightweight Directory Access Protocol: UTF-8 String Representation of Distinguished Names*. It must be encoded in EBCDIC code page 1047.

#### **ejdn\_distinguished\_name\_len**

A binary fullword that, on input, contains the length of the workarea pointed to by `ejdn_distinguished_name_ptr`. Before returning, DFHEJDNX must place in this field the length of the distinguished name it has built.

#### **ejdn\_userid\_ptr**

A pointer to the client's userid.

#### **ejdn\_userid\_len**

A binary fullword containing the length of the client's userid.

**ejdn\_common\_name\_ptr**

A pointer to the proposed common name of the client, derived from the username associated with the client's userid in the external security manager's database.

**ejdn\_common\_name\_len**

A binary fullword containing the length of the client's common name.

**ejdn\_title\_ptr**

A pointer to the proposed title of the client, derived from the title in the X.509 certificate associated with the CorbaServer.

**ejdn\_title\_len**

A binary fullword containing the length of the client's title.

**ejdn\_email\_address\_ptr**

A pointer to the proposed e-mail address of the client, derived from the e-mail address in the (extended) X.509 certificate associated with the CorbaServer.

**ejdn\_email\_address\_len**

A binary fullword containing the length of the client's e-mail address.

**ejdn\_organizational\_unit\_ptr**

A pointer to the proposed organizational unit of the client, derived from the organizational unit in the X.509 certificate associated with the CorbaServer.

**ejdn\_organizational\_unit\_len**

A binary fullword containing the length of the client's organizational unit.

**ejdn\_organization\_ptr**

A pointer to the proposed organization of the client, derived from the organization in the X.509 certificate associated with the CorbaServer.

**ejdn\_organization\_len**

A binary fullword containing the length of the client's organization.

**ejdn\_locality\_ptr**

A pointer to the proposed locality of the client, derived from the locality in the X.509 certificate associated with the CorbaServer.

**ejdn\_locality\_len**

A binary fullword containing the length of the client's locality.

**ejdn\_state\_or\_province\_ptr**

A pointer to the proposed state or province of the client, derived from the state or province (if any) in the X.509 certificate associated with the CorbaServer.

**ejdn\_state\_or\_province\_len**

A binary fullword containing the length of the client's state or province.

**ejdn\_country\_ptr**

A pointer to the proposed country of the client, derived from the country in the X.509 certificate associated with the CorbaServer.

**ejdn\_country\_len**

A binary fullword containing the length of the client's country.

**Note:** Each of the character fields pointed to by an ejdn\_\*\_ptr parameter contains EBCDIC character data terminated by a null character (X'00') to simplify processing in the C language. If a value for a field is not available, the corresponding length field (ejdn\_\*\_len) contains zero.

---

## Sample programs and copy books

The default distinguished name program is an assembler-language program named DFHEJDNX. The source of the default program is provided in assembler-language and C. The corresponding copy book that defines the communications area is provided in assembler-language, C, COBOL, and PL/I. The names of the supplied source programs and copy books, and the CICSTS32.CICS libraries in which they can be found, are summarized in Table 35.

*Table 35. Distinguished name programs and copy books*

<b>Language</b>	<b>Member name</b>	<b>Library</b>
Programs: Assembler C	DFHEJND1 DFHEJND2	SDFHSAMP SDFHSAMP
Copy books: Assembler COBOL PL/I	DFHEJDND DFHEJDNLDFHEJDNH DFHEJDNO	SDFHMAC SDFHC370SDFHCOB SDFHPL1

You can write your own distinguished name program in assembler-language, C, COBOL, or PL/I. You must name it DFHEJDNX.



---

## Chapter 24. Writing an EJB event program

You can write your own EJB event program or use the program provided with CICS, DFHEJEP.

You must be familiar with the methods of defining CORBASERVER and DJAR resources and know how to deploy enterprise beans, as described in *Java Applications in CICS*.

The rest of this section contains:

- “Overview of the EJB event program”
- “The DFHEJEP communications area” on page 680
- “Event codes” on page 681
- “The EJB event sample program” on page 682

---

### Overview of the EJB event program

The EJB event program, DFHEJEP, enables you to monitor certain EJB-related events in a CICS region. The program is invoked for the following EJB events:

#### **CORBASERVER events**

- The start of a scan of a CorbaServer’s deployed JAR file (“pickup”) directory. (The scan searches for new or updated deployed JAR files.)
- The completion of a scan of a CorbaServer’s pickup directory.
- During a scan of a CorbaServer’s pickup directory, the discovery of a deployed JAR file with the same name as one already installed in a different CorbaServer in the same region.

#### **DJAR events**

- A DJAR resource is:
  - Installed
  - Discarded

#### **Bean events**

- An enterprise bean is:
  - Published to the namespace
  - Retracted from the namespace

EJB events are of three types:

- Error
- Informational
- Warning

The primary purpose of the default program is to inform the resource manager for enterprise beans (otherwise known as the RM for enterprise beans) about changes to DJAR resources. For example, if a DJAR fails to install, the EJB event program is driven with an event giving more information than simply “install failed”; the event may, for instance, indicate that there was a UNIX file problem. Your application developers can use the RM for enterprise beans to browse this detailed information.

---

## The DFHEJEP communications area

The DFHEJEP communications area is mapped by the EJEV\_COMMAREA DSECT, which is supplied in the DFHEJEPH copybook.

The information passed in the communications area is as follows:

### **EJEV\_BEANNAME**

The 240-byte name of the bean involved in this event. For some events (for example, the discard of a DJAR) there is no bean name, in which case this field is blank.

### **EJEV\_CORBASERVER**

The 4-byte name of the CorbaServer for which this event is relevant. For example:

- For a scan event, it is the CorbaServer whose “pickup” directory is being scanned.
- For a DJAR successful-install event, it is the CorbaServer into which the DJAR was installed.
- For a DJAR install failure, it is the CorbaServer into which the DJAR failed to be installed.

If, for example, in a region containing two CorbaServers COR1 and COR2, a DJAR fails to be installed in COR2 because a deployed JAR file of the same name is already installed in COR1, the EJEV\_CORBASERVER field contains 'COR2'.

### **EJEV\_DJAR**

The 32-byte name of the DJAR resource to which this event applies. For some events (for example, the start of a scan of a CorbaServer’s deployed JAR file directory) there is no specific DJAR associated with the event, in which case this field is blank.

### **EJEV\_EVENTCODE**

The 1-byte code of the event that has occurred. The possible codes are listed in Table 36 on page 681.

### **EJEV\_EVENTTYPE**

A 1-byte field, indicating what type of event has occurred. The equated values are:

#### **EJEV\_ERROR**

An error event. For example, CICS was unable to access the UNIX file system.

#### **EJEV\_INFO**

An informational event. For example, a DJAR is now in service.

#### **EJEV\_WARNING**

A warning event. For example, a bean could not be retracted from the JNDI namespace because it did not exist.

## Event codes

Table 36 shows the codes and meanings of all EJB events that may be passed to the EJB event program.

*Table 36. EJB event codes. The table shows the event type and meaning of each event code. The “Bean name” column indicates whether the EJEV\_BEANNAME field in the DFHEJEP communications area contains the name of an enterprise bean. The “DJAR name” column indicates whether the EJEV\_DJAR field in the DFHEJEP communications area contains the name of a DJAR resource.*

Event code	Event type	Bean name?	DJAR name?	Description
001	I	N	Y	DJAR resource installed (but not yet resolved).
002	I	N	Y	DJAR discarded.
003	E	N	Y	Install of a DJAR failed because the z/OS UNIX file referred to by the DJAR definition could not be found.
004	E	N	Y	Install of a DJAR failed because CICS could not open a file in the shelf directory for writing.
005	E	N	Y	Install of a DJAR failed because the container encountered problems while processing the contents of the z/OS UNIX file.
006	E	N	Y	Install of a DJAR failed because the z/OS UNIX file associated with the DJAR exists, but could not be read by CICS.
007	E	N	Y	Install of a DJAR failed because an z/OS UNIX I/O exception occurred while reading the z/OS UNIX file.
008	E	N	Y	Install of a DJAR failed because an z/OS UNIX I/O exception occurred while writing to the shelf.
009	E	Y	Y	The deployed JAR file contained a bean whose name contains one or more invalid characters.
010	I	N	Y	DJAR being auto-published.
011	E	Y	Y	Install of a DJAR failed because the deployed JAR file contained a bean which has already been installed in the CorbaServer.
012	E	Y	N	Publishing the bean to the namespace failed.
013	I	N	Y	DJAR definition created during a scan.
014	I	N	Y	DJAR definition updated during a scan.
015	I	Y	N	A bean was published successfully.
016	I	Y	N	A bean was successfully retracted from the namespace.
017	W	Y	N	A bean could not be retracted, because it could not be found in the namespace.
018	E	N	Y	Update of a DJAR failed because CICS was unable to delete the existing deployed JAR file from the shelf during DJAR install.
019	I	N	N	A scan of a CorbaServer’s “pickup” directory has started.

Table 36. EJB event codes (continued). The table shows the event type and meaning of each event code. The “Bean name” column indicates whether the EJEV\_BEANNAME field in the DFHEJEP communications area contains the name of an enterprise bean. The “DJAR name” column indicates whether the EJEV\_DJAR field in the DFHEJEP communications area contains the name of a DJAR resource.

Event code	Event type	Bean name?	DJAR name?	Description
020	I	N	N	A scan of a CorbaServer’s “pickup” directory has ended.
021	E	N	Y	During a scan of a CorbaServer’s pickup directory, CICS has discovered a deployed JAR file with the same name as one already installed in a different CorbaServer in the same region.

---

## The EJB event sample program

### Actions of the default program

The default implementation of DFHEJEP is provided to support the RM for enterprise beans. It is intended to be installed in CICS regions that are used for application development. We recommend that you install the default program in your development regions.

The default program records useful EJB events in a file named DFHADEM. It records only a subset of all possible EJB events—only the ones that may help an application developer determine why there is a problem with a DJAR. Because CICS categorizes each EJB event in one of three types (informational, warning, or error), DFHEJEP can discard whole groups of uninteresting events by checking for a single value in the communications area.

Your application developers can use the RM for enterprise beans to query the contents of DFHADEM. This enables them to check the outcome of DJAR requests and the status of DJAR resources in the region.

Before recording any events, the default program determines (by checking for the existence of file DFHADEM) whether the RM for enterprise beans is being used in the region; if it is not, the default program records no events and ends. This means that there is no processing overhead in a production region, in which the RM for enterprise beans would not normally be used.

### Writing your own EJB event program

You can write your own EJB event program in any of the languages supported by CICS. The default EJB event program is a C language program named DFHEJEP. The source of the default program is provided in C. The corresponding copy book that defines the communications area is provided in assembler-language, C, COBOL, and PL/I. The names of the supplied source programs and copy books, and the CICSTS32.CICS libraries in which they can be found, are summarized in Table 37.

Table 37. EJB event programs and copy books

Language	Member name	Library
Programs: C	DFHEJEP	SDFHC370



Table 37. EJB event programs and copy books (continued)

Language	Member name	Library
Copy books: <ul style="list-style-type: none"><li>• Assembler</li><li>• C</li><li>• COBOL</li><li>• PL/I</li></ul>	<ul style="list-style-type: none"><li>• DFHEJEPD</li><li>• DFHEJEPH</li><li>• DFHEJEPO</li><li>• DFHEJEPL</li></ul>	<ul style="list-style-type: none"><li>• SDFHMAC</li><li>• SDFHC370</li><li>• SDFHCOB</li><li>• SDFHPL1</li></ul>

You can use the supplied program as the basis of your own EJB event program. Your program could, for example, use different criteria than the default program to filter the EJB events passed to it; or send the filtered events to a different destination.

An implementation of DFHEJEP does not have to be particularly efficient, because none of the EJB events for which DFHEJEP is driven occur during the execution of normal EJB method calls.



---

## Chapter 25. Writing programs to customize Language Environment run-time options for XPLink programs

### Considerations common to all user-replaceable programs

Note that the comments contained in Chapter 5, “General notes about user-replaceable programs,” on page 435 apply to this chapter.

This chapter describes how to write a user-replaceable program that will be called by CICS during the initialization of the Language Environment enclave for a C or C++ program compiled with the XPLINK option.

The program is :

- “DFHAPXPO”

---

### DFHAPXPO

This program is loaded during the PIP1 preinitialization phase of each Language Environment enclave where C or C++ programs compiled with the XPLINK option are to be run. It allows you to alter the default Language Environment run-time options. See the *z/OS Language Environment Programming Guide* for details of the Language Environment options that can be reset. The program must be written in Assembler language.

### Defining run-time options

The options are specified as a human-readable string containing a 2-byte string length followed by the run-time options. The maximum length allowed for all Language Environment run-time options is 255 bytes, so you are recommended to use the abbreviated version of each option and restrict your changes to a total of under 200 bytes. The values you specify are not checked by CICS before being passed to Language Environment.

A CICS-supplied DFHAPXPO module is provided, setting some run-time options. See the fully-commented module source for an example of how to set these options.

CICS programs can include a CEEUOPTS CSECT to supply Language Environment run-time options to control the program's execution.



---

## Part 4. Customizing the XRF overseer program

**A general note about user-written programs:**

On return from any user-written program, CICS must always receive control in primary-space translation mode, with the original contents of all access registers restored, and with all general purpose registers restored (except for those which provide return codes or linkage information).

For information about translation modes, refer to the *IBM ESA/370 Principles of Operation* manual.

---

## Chapter 26. The extended recovery facility overseer program

The information in this chapter is of interest only to users of the extended recovery facility (XRF). Details of XRF are provided in the *CICS/ESA 3.3 XRF Guide*.

The XRF overseer program has two major functions:

- To display the current status of active and alternate CICS regions
- To restart failed CICS regions in place without operator intervention.

There is a CICS-supplied sample overseer program that performs these two functions and which you may find adequate for your installation.

The chapter is divided into the following sections:

1. “The sample XRF overseer program” contains:
  - “The functions of the sample program”
  - “How the sample overseer program interfaces with CICS” on page 693
  - “How to tell the overseer which actives and alternates to monitor” on page 693.
2. “The DFHWOSM macros” on page 695 describes the macros that you use to provide services to the overseer program.
3. “Customizing the sample XRF overseer program” on page 703 describes how you can extend the functions of the sample program.

---

### The sample XRF overseer program

The CICS-supplied sample overseer is an assembler-language batch program that runs in its own address space. The source of the sample program is in four members of CICSTS32.CICS.SDFHSAMP:

- DFH\$AXRO
- DFH\$AGCB
- DFH\$ADSP
- DFH\$ARES.

The associated DSECTs are supplied in DFH\$XRDS in the same library. An assembled version of the sample program is supplied in CICSTS32.CICS.SDFHAUTH.

### The functions of the sample program

The program acts on five commands entered by the console operator. (Minimum abbreviations are shown like this: D.) The commands are as follows:

**Display**

to display the current status of all active-alternate pairs being monitored by the overseer program

**Restart**

to enable or disable the restart-in-place function of the overseer program

**Snap**

to take a snap dump of the sample program

### End

to terminate the sample program

### Open

to ask the overseer to try to open CICS availability manager (CAVM) data sets that it has previously failed to open.

The full format of the operator command entered at the MVS console is:

```
MODIFY overseer-jobname,command-identifier
```

where “command-identifier” is Display, Restart, Snap, End, or Open, or an abbreviation of any of these. The Display and Restart commands control the two major functions of the sample overseer program, which are described below. The Open command is described under “Opening CAVM data sets dynamically” on page 692.

## The display function

When the operator enters the Display command at the MVS console, the sample overseer program issues a multiline write-to-operator (MLWTO) command showing the last known state of each of the active-alternate pairs that it is monitoring. The overseer retrieves this information from the control and message data sets, in which the CICS availability manager (CAVM) has been recording state and surveillance information. The display includes a title line and one line of status information for each active-alternate pair. The title line is as follows:

```
GEN-APP ACT-JOB ACT-APP ACPU A-ST BKP-JOB BKP-APP BCPU B-ST
```

Each line of status information provides the following:

- The generic applid of the active-alternate pair (GEN-APP)
- The CICS job name of the active (ACT-JOB) and of the alternate (BKP-JOB)
- The specific applid of the active (ACT-APP) and of the alternate (BKP-APP)
- The SMF IDs of the CPUs on which the active and the alternate were last known to be executing (ACPU and BCPU)
- The last known status of the active (A-ST) and of the alternate (B-ST). The status value can be one of the following:

**ACT** Active signed on normally and running the active CICS workload.

**BACK** Alternate signed on and running normally.

**SOFN** Signed off normally.

**SOFA** Signed off abnormally.

**TKOV** Taking over (alternate only).

**INCA** Incipient active, meaning that an alternate CICS is taking over from an active CICS. The active job has signed off abnormally, and the incipient active is waiting for the active job to terminate.

**TKIP** Takeover in progress. An alternate CICS is attempting a takeover of this active system. When the takeover is complete, the status is changed.

**UNKN** Unknown—the overseer has no current information about the status, which was in an intermediate state when the Display command was processed. Reissuing the Display command causes UNKN to be replaced by another status value.

**OLD** The information displayed for the alternate refers to out-of-date information about the system that was the alternate until a recent



takeover. That system is the current active, and the information displayed for the alternate is marked as OLD until a new alternate is signed on and running normally.

An example of the status display is shown, for guidance purposes, in the *CICS Operations and Utilities Guide*.

**Note:** An 'X' following any of these status values indicates that the associated job is currently executing. However, because JES services are used to discover the execution state of a job, only those jobs that are running on the same JES as the overseer program (or on the same JES shared spool) show the correct execution state. Any job that is not on the same JES shared spool appears not to be executing.

There are two additional items that may appear on the status display. These are:

- **NO ACTIVE DATA**
- **NO BACKUP DATA.**

These are displayed instead of status data when no data was extracted from the CAVM data sets. This happens when newly-created data sets are used—CICS has not yet written any data to them—or when the overseer fails to open the data sets.

### **The restart-in-place function**

The overseer program can restart failed CICS regions in place automatically, if they are in the same MVS image as the overseer. The alternatives to automatic restart are operator-initiated restart, automatic takeover to the alternate, and operator-initiated takeover.

Automatic restart in place of failed regions is most useful in the multi-MVS image MRO environment. Because related regions must operate in the same MVS image, a takeover of one region means that all related regions must also be taken over by their alternates. A region may not be important enough for you to want every failure to cause a takeover to the alternate MVS image. This could disrupt users who would not otherwise have been affected by the failure. Automatic restart in place of the failed region is therefore likely to be preferred to takeover in these circumstances.

If your system consists of one or more independent regions, with actives and alternates located in separate MVS images, you can:

- Allow the overseer to restart an active region in place automatically when it fails.
- Choose automatic takeover by the alternate.
- Leave the operator to decide what to do. The operator could decide to restart the failing region in place or to initiate a takeover by the alternate, and this decision is likely to depend on which part of your system has failed.

If you are operating an MRO system in a single MVS image, the failure of an active region can be handled by a takeover by the alternate, without causing all the related regions to be taken over, because the new active region can continue communication with the other active regions. Takeover is therefore likely to be your preferred course of action.

**Enabling and disabling restart in place:** The restart-in-place function of the overseer program can be enabled and disabled using the Restart command. When you enter this command, restart processing is enabled or disabled for all generic applids that the overseer is monitoring. You can also specify that particular

active-alternate pairs are not to be automatically restarted in place, regardless of whether restart processing is enabled or disabled. This is described in “How to tell the overseer which actives and alternates to monitor” on page 693.

The Restart command works like an ON/OFF switch. Restart in place is enabled when the sample program is initialized. When the Restart command is first entered, restart in place is disabled. If you issue the command again, restart is enabled again, and so on. If a region fails while restart in place is disabled, no attempt to restart it is made, even if restart in place is enabled again.

#### **Rules that control restart in place:**

The sample overseer program concludes that a region has failed if both:

- The region is not executing now, and was known to have been executing during the previous examination of the relevant CAVM data sets by the overseer.
- The region did not sign off normally from the CICS availability manager (CAVM).

The overseer program can restart a failed **active** region in place, if all the following conditions are met:

- Restart in place is enabled for this overseer.
- Restart in place is enabled for this active-alternate pair.
- There is no executing alternate region for this active, or the alternate region is currently defined with TAKEOVER=COMMAND. If the alternate region is defined with TAKEOVER=AUTO or TAKEOVER=MANUAL, the overseer assumes that the alternate will initiate a takeover or that the console operator will decide what action to take.
- The failing region was running in the same MVS image as the overseer.
- An attempt to restart the region in place is not already in progress.
- If the failing region belongs to a group of related regions (an MRO environment, for example), a takeover to another MVS image, perhaps initiated by another region, is not under way.

When a failed active region is restarted in place, whether by the operator or by the overseer, the corresponding alternate region cannot continue to support the new active region, and must be restarted. The overseer program restarts the **alternate** region automatically in these circumstances, if restart processing is enabled for both the failing region and the overseer.

If you want to be able to restart regions in place in both MVS images in a two-image environment, an overseer program must execute in each image.

If the failed region was started originally as a started task, the overseer program restarts it as a started task, and if the failed region was started as a job, the overseer restarts it as a job. For more guidance information about how the sample overseer program restarts failed regions in place, refer to Replying to messages, in the *CICS Operations and Utilities Guide*.

#### **Opening CAVM data sets dynamically**

When the overseer program is initialized, it is possible that some CAVM data sets have not yet been formatted by a CICS system. The overseer program obtains an ‘open error’ return code on these data sets, and subsequent attempts to display details about the associated CICS systems receive the response ‘NO ACTIVE DATA AVAILABLE’.

This problem arises only if the overseer is initialized before all the CAVM data sets have been formatted. If it occurs, the operator can use the Open command (see Open ) to retry the opening of those CAVM data sets on which the Open previously failed. The overseer retries an Open only if the previous attempt failed with the return code X'C'. (See “DFHWOSM FUNC=OPEN macro” on page 698.)

The use of the Open command is indicated when:

- The overseer displays 'NO ACTIVE DATA AVAILABLE' for a system that the operator knows has successfully signed on to the CAVM.
- In an already established XRF environment, a new CICS/XRF system has just started up and formatted its CAVM data sets, and the operator wants future displays from the overseer to display information for the new job.

## How the sample overseer program interfaces with CICS

The overseer service is made up of a CICS overseer module (name DFHWOS), which you cannot customize, and a CICS-supplied sample overseer program (module name DFH\$AXRO), which you can customize or replace with your own overseer program. DFHWOS loads the overseer program. DFHWOS and the compiled version of DFH\$AXRO are supplied in CICSTS32.CICS.SDFHAUTH.

The CICS overseer module DFHWOS provides a stable interface to the CAVM data sets and to those MVS-authorized services that the overseer program requires. The overseer program invokes those services by means of a CICS-supplied group of macros called the DFHWOSM macros, which are described in “The DFHWOSM macros” on page 695.

DFHWOS therefore invokes the sample program, and is subsequently invoked by the sample program whenever the sample issues a DFHWOSM macro. The DFHWOSM macros do not interact directly with either the active or the alternate CICS address spaces.

## How to tell the overseer which actives and alternates to monitor

The sample overseer program is written to handle active-alternate pairs and “related system names”. A related system name identifies those regions or systems that cannot be considered in isolation by the overseer. The most common example of this is an MRO environment, where the overseer needs to be able to identify related regions when deciding whether to restart a failed region in place. Those regions or systems that are identified with a common related system name must be executed in the same MVS image.

The maximum number of active-alternate pairs that the overseer can monitor is 50.

The sample program discovers which active-alternate pairs it is monitoring from a VSAM key-sequenced data set called DFHOSD, which contains a single entry for each active-alternate pair. You create this data set and initialize it with information about active-alternate pairs before you use the overseer for the first time. You also have to redefine the DFHOSD data set whenever you want to change the information that it holds. CICS provides a sample job stream that you can use to:

- Delete and define the DFHOSD data set
- Initialize the DFHOSD data set with information about sample active-alternate pairs
- Execute the overseer code and the sample overseer program.

The sample overseer program reads the DFHOSD records in key sequence and builds a table of entries. Each active-alternate pair is known by its generic applid on this data set. Every entry on the data set contains the following information:

- A 12-byte key field, containing the 4-byte value 'GNbb' followed by the 8-byte generic applid of the active-alternate pair.
- The ddnames of the control data set and the message data set associated with this generic applid. Each of these is an 8-byte value.
- An optional 8-byte RELATEID, to identify related systems.
- A restart-in-place indicator to show whether a region can be restarted in place. The only value that prevents an attempt to restart in place is 'N'.

The data structure of the DFHOSD data set entries is provided in member DFH\$XRDS of CICSTS32.CICS.SDFHSAMP.

You can use the job in Figure 67 to create and initialize DFHOSD.

```
//DEFOSD JOB accounting information,CLASS=A,
//          MSGLEVEL=(1,1),MSGCLASS=A,NOTIFY=userid
//DEFDS   EXEC PGM=IDCAMS
//DDNAME1 DD VOL=SER=volid,UNIT=SYSDA,DISP=SHR
//SYSPRINT DD SYSOUT=A
//SYSIN   DD *
DELETE ('CICSTS32.DFHOSD') PURGE CLUSTER
DEFINE CLUSTER (TRACKS(1,1) -
NAME (CICSTS32.DFHOSD) -
SHAREOPTIONS(2) -
VOLUMES (volid) -
FILE (DDNAME1)) -
DATA -
(RECORDSIZE(80,80) -
CONTROLINTERVALSIZE(2048) -
NAME (CICSTS32.DATA.DFHOSD) -
KEYS(12,0) -
INDEX -
(NAME(CICSTS32.INDEX.DFHOSD)) -
/*
//INITOSD EXEC PGM=IDCAMS
//SYSPRINT DD SYSOUT=A
/* COLUMN
/* 1 5 14 23 32 41
/* GN genappl relsysid ddnxrctl ddnxrmsg ind
/*
//SYS01 DD *
GN DBDCCICS CTLDBDC MSGDBDC
GN DBDCMR01 MROSYS CTLMR01 MSGMR01 N
GN DBDCMR02 MROSYS CTLMR02 MSGMR02
GN DBDCMR03 MROSYS CTLMR03 MSGMR03
/*
//SYSIN DD *
REPRO INFILE ( SYS01 ) -
OUTDATASET (CICSTS32.DFHOSD)
/*
```

Figure 67. Sample job to create and initialize the DFHOSD data set

**1** This entry is for an XRF system that is not associated with any other CICS region, and does not require a related system identifier. This entry is suitable to use with the XRF IVPs supplied with CICS and described in the *CICS/MVS Installation Guide*.

**2** The last three entries are for three related MRO regions that are identified by the related system name of MROSYS. One of these is not allowed to restart in place and is indicated by the letter N.

---

## The DFHWOSM macros

The DFHWOSM macros invoke the CICS module DFHWOS to provide services to the overseer program. The macros are the supported interface to the CAVM data sets, and are supplied to perform the following functions:

**DFHWOSM FUNC=BUILD**

Open communication with DFHWOS

**DFHWOSM FUNC=CLOSE**

Terminate access to the CAVM data sets for a named generic applid

**DFHWOSM FUNC=DSECT**

Generate required DSECTS

**DFHWOSM FUNC=JJC**

Issue a JES cancel for a named job

**DFHWOSM FUNC={JJSIQJJS}**

Discover current JES JOB status

**DFHWOSM FUNC=OPEN**

Initialize access to the CAVM data sets for a named generic applid

**DFHWOSM FUNC=OSCMD**

Issue MVS commands

**DFHWOSM FUNC=READ**

Retrieve status information for a named generic applid from the CAVM data sets

**DFHWOSM FUNC=TERM**

Close communication with DFHWOS.

The macros are described in detail in the following sections. For all the DFHWOSM macros, the following rules apply:

- The “label” field is optional.
- If the macro has an input parameter list, the address of that parameter list must be supplied as the value of the PARM operand. The address itself may be specified as a register number or as a label. Register 1 is the default value.
- If the macro has to supply either a BUILD TOKEN or an OPEN TOKEN to DFHWOS (as described in “The DFHWOSM tokens”), the token must be provided in the register specified in the TOKEN operand. Register 14 is the default value.

## The DFHWOSM tokens

When DFHWOS first invokes the overseer program, it passes a value in register 1 which is known as the **ENTRY** token. The ENTRY token value is stored by the overseer program on entry and is passed back to DFHWOS as input to the BUILD, OSCMD, JJS, and JJC macros.

The DFHWOSM FUNC=BUILD macro must be the first macro issued by the overseer program and must complete successfully. The register 1 output from this macro is a second token called the **BUILD** token. The BUILD token value is stored

by the overseer program and passed back to DFHWOS as input to the OPEN, CLOSE, READ, QJJS, and TERM macros.

## DFHWOSM FUNC=BUILD macro

The DFHWOSM FUNC=BUILD macro must be issued by the overseer program to initialize its communication with DFHWOS. No other macro can be issued by the overseer program until DFHWOS FUNC=BUILD has completed successfully.

```
label DFHWOSM FUNC=BUILD  
      [,TOKEN={token register|14}]
```

### Input

The TOKEN value is the ENTRY token that was passed to the sample overseer program when it was first invoked by DFHWOS.

### Output

#### Register 1

Contains the BUILD token value, which must be returned as an input value by the overseer program on certain subsequent requests. This value is returned to register 1 only if register 15 has a return code of '0'.

#### Register 15

Contains one of the following completion codes:

- 0 Communication successfully initialized between the overseer program and DFHWOS
- 4 Incorrect TOKEN value supplied
- 8 Insufficient storage.

## DFHWOSM FUNC=CLOSE macro

The DFHWOSM FUNC=CLOSE macro terminates access to the CAVM data sets for a named generic applid.

```
label DFHWOSM FUNC=CLOSE  
      [,PARM={parm address|1}]  
      [,TOKEN={token register|14}]
```

### Input

The PARM value is a pointer to the address of the generic applid whose associated CAVM data sets are no longer to be accessed by the overseer program.

The TOKEN value is the BUILD token.

### Output

#### Register 15

Completion codes:

- 0 CLOSE request was successful and the CAVM data sets associated with this generic applid can no longer be accessed by the overseer program.
- 4 Incorrect TOKEN value supplied.
- 8 Access to CAVM data sets for the named generic applid had not been initialized.

## DFHWOSM FUNC=DSECT macro

The DFHWOSM FUNC=DSECT macro generates a number of DSECTs, including the DSECT of the DBLID definitions.

```
DFHWOSM FUNC=DSECT
```

## DFHWOSM FUNC=JJC macro

The DFHWOSM FUNC=JJC macro issues a JES cancel for a named job with a JES job identifier.

```
DFHWOSM FUNC=JJC  
[,PARM={parm address|1}]  
[,TOKEN={token register|14}]
```

### Input

The PARM value is a pointer to the addresses of the following:

- An 8-byte job name
- An 8-byte JES job ID
- A 256-byte SSOB return area.

The TOKEN value is the ENTRY token.

### Output

#### Register 15

Contains the following completion codes:

**0** JES cancel completed; SSOB and status array returned from JES

#### Nonzero

Return code from JES.

## DFHWOSM FUNC={JJS|QJJS} macro

Supplied with a job name and JES job identifier, both versions of the DFHWOSM FUNC={JJS|QJJS} macro return the current JES job status into a copy of the JES subsystem options block (SSOB).

The FUNC=JJS macro returns control when the JES call has completed successfully or unsuccessfully. The FUNC=QJJS macro returns control immediately and posts an event control block (ECB) once the JES request has completed.

```
label DFHWOSM FUNC={JJS|QJJS}  
[,PARM={parm address|1}]  
[,TOKEN={token register|14}]
```

### Input

For FUNC=JJS, the PARM value is a pointer to the addresses of the following:

- An 8-byte job name
- An 8-byte JES job ID
- A 256-byte SSOB return area.

The TOKEN value is the ENTRY token.

For FUNC=QJJS, the PARM value is a pointer to the addresses of the following:

- An 8-byte job name
- An 8-byte JES job ID
- A 256-byte SSOB return area
- A doubleword area to hold two ECBs.

The FUNC=QJJS macro requires 2 ECBs: the first is posted when the JES call completes; the second is posted if a time-out occurs before JES returns.

The TOKEN value is the BUILD token.

#### Output

##### Register 15

Contains the following completion codes:

**0** JES status returned as requested in the SSOB return area

##### Nonzero

Return code from JES.

## DFHWOSM FUNC=OPEN macro

The DFHWOSM FUNC=OPEN macro initializes access to the CAVM data sets for a named generic applid.

```
label DFHWOSM FUNC=OPEN
      [,PARM={parm address|1}]
      [,TOKEN={token register|14}]
```

#### Input

The PARM value is a pointer to three further addresses, and these are:

1. The address of the generic applid
2. The address of the ddname of the control data set
3. The address of the ddname of the message data set.

The TOKEN value is the BUILD token.

#### Output

##### Register 15

Contains one of the following completion codes:

**0** Access initialized, active and alternate signed on

**1** Access initialized, active signed on

**2** Access initialized, alternate signed on

**3** Access initialized, nothing signed on

**4** Same SMF MVS name; IPL time of active earlier than MVS IPL time

**5** Same SMF MVS name; IPL time of alternate earlier than MVS IPL time

**6** Insufficient storage

**7** Generic applid is not associated with the named CAVM data sets



- 8** Access already initialized for this generic applid or for this ddname
- 9** Version numbers of the named CAVM data sets do not match
- C** Data set open failure
- 10** SHOWCB failure.

A register 15 return code value of '0' through '5' indicates that a DFHWOSM FUNC=READ macro can now be issued. A return code value of '6' or above indicates that the OPEN has failed and that the overseer program will not be able to access the CAVM data sets.

## DFHWOSM FUNC=OSCMD macro

The DFHWOSM FUNC=OSCMD macro is used to issue MVS commands. (The overseer program restarts a failed region in place by issuing this macro.) The text of the required MVS command is provided as input to the macro, and the OSCMD service issues an SVC 34 specifying this command text. In addition, the OSCMD service issues an MVS WTO request so that a copy of the command text appears on the MVS console to keep the operator informed of what is about to happen. This copy has the comment '(BY IOP)' appended to show that the command is going to be issued by an overseer program. A second copy of the command text is sent to the console when the MVS command is issued.

```
label DFHWOSM FUNC=OSCMD
      [,PARM={parm address|1}]
      [,TOKEN={token register|14}]
```

### Input

The PARM value is a single address that points to a "command area". The command area is made up of a 4-byte length field followed by the command data. The length field contains the length of the whole command area. The command data must be in write-to-operator (WTO) command format.

The TOKEN value is the ENTRY token.

### Output

#### Register 0

Completion code set by SVC 34 as a response to the MVS command that was issued by the macro.

#### Register 15

Response to the macro itself. A return code of '16' indicates that the OSCMD has failed.

## DFHWOSM FUNC=READ macro

The DFHWOSM FUNC=READ macro returns information about a named generic applid from its associated CAVM data sets.

```
label DFHWOSM FUNC=READ
      [,PARM={parm address|1}]
      [,TOKEN={token register|14}]
```

### Input

The PARM value is a pointer to a parameter list that contains the addresses of the generic applid and the “dbllist”. The dbllist is a list of one or more doublewords.

In the first two bytes of the second word of each of these doublewords you supply the DBLID of the information you require. Each piece of information that you can request is identified by a DBLID, and a list of these is provided in Figure 69 on page 701.

The first word of each doubleword is an output area to contain the address of the requested information, and the last two bytes of the second word of each doubleword contain the length of the information. The end of the dbllist is signaled by setting the high-order bit of the last doubleword to ‘1’. Figure 68 illustrates the input to and output from the READ macro.

The TOKEN value is the BUILD token.

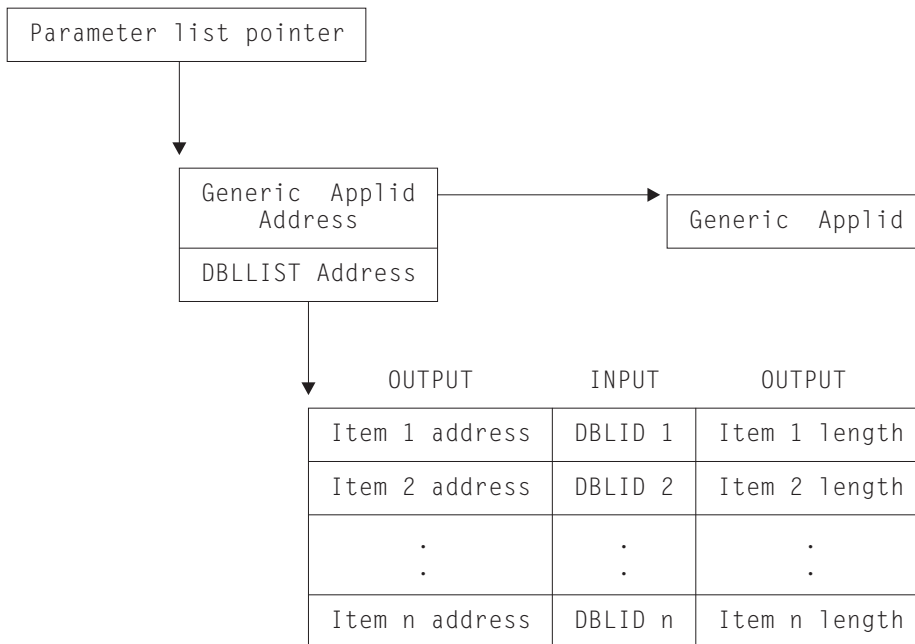

Figure 68. Input to and output from the DFHWOSM FUNC=READ macro

DBLIDs for the active:

DBLID1	EQU	X'0001'	JOB NAME
DBLID2	EQU	X'0002'	JES JOB ID
DBLID3	EQU	X'0003'	JOB SUBMISSION TIME (STIME)
DBLID4	EQU	X'0004'	JOB STEP TASK ATTACH TIME (ATIME)
DBLID5	EQU	X'0005'	CANCEL NAME
DBLID6	EQU	X'0006'	JES SSNAME
DBLID7	EQU	X'0007'	MVS SMF NAME
DBLID8	EQU	X'0008'	MVS IPL TIME
DBLID9	EQU	X'0009'	SPECIFIC APPL NAME
DBLID10	EQU	X'000A'	ADDRESS SPACE IDENTIFIER (ASID)
DBLID11	EQU	X'000B'	RESTART TYPE
DBLID12	EQU	X'000C' - X'001F'	SPARE FOR STATE CTL ITEMS
DBLID32	EQU	X'0020'	HEARTBEAT INTERVAL
DBLID33	EQU	X'0021'	HEARTBEAT COUNTER
DBLID34	EQU	X'0022'	MSG FILE CURSOR
DBLID35	EQU	X'0023'	STATUS VALUE (STATE)
DBLID36	EQU	X'0024'	INQUIRE HEALTH DATA
DBLID37	EQU	X'0025'	INQUIRE GLOBAL DATA
DBLID38	EQU	X'0026'	SYSPLEX NAME
DBLID39	EQU	X'0027'	MVS SYSTEM NAME
DBLID40	EQU	X'0028'	MVS SYSTEM TOKEN

DBLIDs for the alternate:

DBLID257	EQU	X'0101'	JOB NAME
DBLID258	EQU	X'0102'	JES JOB ID
DBLID259	EQU	X'0103'	JOB SUBMISSION TIME (STIME)
DBLID260	EQU	X'0104'	JOB STEP TASK ATTACH TIME (ATIME)
DBLID261	EQU	X'0105'	CANCEL NAME
DBLID262	EQU	X'0106'	JES SSNAME
DBLID263	EQU	X'0107'	MVS SMF NAME
DBLID264	EQU	X'0108'	MVS IPL TIME
DBLID265	EQU	X'0109'	SPECIFIC APPL NAME
DBLID266	EQU	X'010A'	ADDRESS SPACE IDENTIFIER (ASID)
DBLID267	EQU	X'010B'	RESTART TYPE
DBLID268	EQU	X'010C' - X'011F'	SPARE FOR STATE CTL ITEMS
DBLID288	EQU	X'0120'	HEARTBEAT INTERVAL
DBLID289	EQU	X'0121'	HEARTBEAT COUNTER
DBLID290	EQU	X'0122'	MSG FILE CURSOR
DBLID291	EQU	X'0123'	STATUS VALUE (STATE)
DBLID292	EQU	X'0124'	INQUIRE HEALTH DATA
DBLID293	EQU	X'0125'	INQUIRE GLOBAL DATA
DBLID294	EQU	X'0126'	SYSPLEX NAME
DBLID295	EQU	X'0127'	MVS SYSTEM NAME
DBLID296	EQU	X'0128'	MVS SYSTEM TOKEN

Figure 69. DBLIDs for the DFHWOSM FUNC=READ macro

**Note:**

1. The data structures of the status information pointed to by items X'0024' and X'0124' are provided in DSECT DFHXRHDS of CICSTS32.CICS.SDFHMAC.
2. The data structures of the status information pointed to by items X'0025' and X'0125' are provided in DSECT DFHXRGDS of CICSTS32.CICS.SDFHMAC.
3. The data structures of the status information pointed to by items X'000B' and X'010B' are mirrors of the field WSJRST in DSECT WSJDESC within DFHWSMDS.

**Output**

**Register 15**

Contains one of the following completion codes:

- 0 Read successful, active and alternate signed on
- 1 Read successful, active signed on
- 2 Read successful, alternate signed on.
- 3 Read successful, nothing signed on
- 4 Same SMF MVS name; IPL time of active earlier than MVS IPL time
- 5 Same SMF MVS name; IPL time of alternate earlier than MVS IPL time
- 8 CAVM data set access not initialized
- 10C DBLID not known
- 1xx Read subtask problem.

If a completion code of '0' through '5' is returned to register 15, each doubleword of the DBLLIST contains the address (4 bytes) and the length (2 bytes) of the output from this read. A completion code of '8', '10C', or '1xx' indicates a READ failure.

### **Reading DBCTL status information from the CAVM data sets**

If you are using DBCTL and have active and alternate DBCTL subsystems, status information about the subsystem connected to the active CICS is written to the CAVM data sets. However, the supplied sample overseer program does not read the DBCTL information from the CAVM data set. If you want the overseer to retrieve this information and to display or use it, you must write your own overseer program.

The information in the CAVM data set about the connected DBCTL subsystem is updated when the active CICS:

- Establishes a connection to a DBCTL subsystem
- Disconnects normally from a DBCTL subsystem
- Loses a connection to a DBCTL subsystem.

If more than one active CICS is connected to a single DBCTL subsystem, the CAVM data set for each CICS contains information about the same DBCTL subsystem. The overseer can recognize this situation because in every case the DBCTL startup time stamp is the same.

Copy book DFHDXGHD contains the information shown in Figure 70 on page 703.

DFHDXGHD	DSECT		
GHDDXADB	DS	CL4	DBCTL SSID
GHDDXRSE	DS	CL8	IMS RSE name
GHDDXCTM	DS	CL4	IMS connect time
GHDDXDTM	DS	CL4	IMS disconnect time
GHDDXJNM	DS	CL8	JES Job name of old active IMS
GHDDXJID	DS	CL8	JES Job ID of old active IMS
GHDDXASD	DS	H	ASID of old active IMS
GHDDXIRT	DS	X	IMS region type
DXRHTSBY	EQU	X'01'	region type is hot standby
DXRDBDC	EQU	X'02'	region type is IMS DB/DC
DXRDBCTL	EQU	X'04'	region type is DBCTL
GHDDXTYP	DS	X	GHD message type
DXMCNCT	EQU	X'01'	Message type = DBCTL connection
DXMDISC	EQU	X'02'	Message type = DBCTL disconnect
DXMDRAF	EQU	X'04'	Message type = DRA failure
DXMABEND	EQU	X'08'	Message type = DBCTL abend
DXMERROR	EQU	X'80'	Indicates severe error in DFHDBCT
DXGHDLEN	EQU	*-DFHDXGHD	length of CICS XRF/DBCTL GHD
	ORG	,	

Figure 70. DFHDXGHD copy book

## DFHWOSM FUNC=TERM macro

The DFHWOSM FUNC=TERM macro terminates communication between the overseer program and DFHWOS, and releases any associated storage. It must be issued before the overseer program completes to ensure an orderly termination.

```
label    DFHWOSM FUNC=TERM
         [,TOKEN={token register|14}]
```

### Input

The TOKEN value is the BUILD token.

### Output

#### Register 15

Contains the following completion codes:

**0** Communication terminated successfully

#### Nonzero

Request failed.

---

## Customizing the sample XRF overseer program

The sample overseer program consists of four modules link-edited together. The main module is **DFH\$AXRO**; the other three modules are subroutines, described below:

### DFH\$AGCB

sets up request parameter lists (RPLs), access method control blocks (ACBs), and parameter lists.

### DFH\$ADSP

displays status information.

### DFH\$ARES

performs restart in place.

The associated DSECTs are provided in member DFH\$XRDS of CICSTS32.CICS.SDFHSAMP. There are several ways in which you can change the supplied code to make the overseer program more suitable for your installation.

Here are some customization suggestions:

- If the supplied display of status information (DSECT DSPDS) is not suitable, you can change the layout for your installation. You may also want to change the content of the status display if you are using DBCTL. The supplied sample overseer program does not read the DBCTL-related information from the CAVM data sets, and so cannot display DBCTL information on the MVS console. If you want this to be displayed, you have to issue a DFHWOSM FUNC=READ macro to retrieve the global data, and you have to change the status display to accommodate the extra information. See “DFHWOSM FUNC=READ macro” on page 699.
- The CSECT DFH\$ADSP can be customized so that, for example, status information is displayed automatically at regular intervals, or whenever a region is in trouble, as well as when the console operator enters the Display command. This would require interpretation of the status information by the overseer.
- Any of the messages to the system console, which are listed in the prolog of the source module DFH\$AXRO, can be changed.
- You can change the format or the content of the DFHOSD data set (DSECT OSDDS) if, for example, you want it to contain more information.
- You can change the restart function so that, for example, a failed region is restarted only during periods of heavy use, while at other times a takeover to the alternate is initiated by the operator.
- When an active region fails and is taken over by the alternate, the old active region must be restarted as the new alternate. In those cases where the cause of the takeover was not an MVS failure, restart of the old active as an alternate region could be automated in the overseer program.
- To extend the function of the overseer program, you can incorporate the CEBT command, which is normally issued by the console operator to control the alternate. The CEBT command is described in the *CICS Supplied Transactions* manual.

All of the CEBT functions are available for use in the overseer program, though it is unlikely that you will find it helpful to automate all of them, and there would, in some cases, be difficulties in handling the responses from the INQUIRE commands. However, it might be helpful for you to be able to automate the takeover process in some circumstances. Here are two examples of situations in which you could use the CEBT command to influence or to initiate takeover from the overseer program:

- The active CICS may place error information in the CAVM data sets when a VTAM failure occurs, depending on whether you have coded an exit program at the global user exit point XXRSTAT, and, if so, how you have coded it. (An exit program at this point can be used to decide whether or not VTAM failure data is recorded in the CAVM data sets.) If such data is placed in the CAVM data sets, information about the last eight failures detected by the active CICS region is available to the overseer. The overseer can evaluate this information and, if necessary, initiate a takeover by issuing the following CEBT command:  

```
MODIFY jobname,CEBT PERFORM TAKEOVER
```

In this case, you should ensure that the actions taken by the global user exit program at exit point XXRSTAT do not conflict with or duplicate those taken by the overseer program. For example, it would be possible for the global

user exit program to request a CICS abend, and thereby initiate a takeover, and for the overseer program to issue the PERFORM TAKEOVER command while acting on the same information.

- At particular times of the day, perhaps when fewer operational staff are available than at other times, you may find it convenient to change the TAKEOVER setting for some, or all, of your regions. For example, you can change the TAKEOVER value for a region from COMMAND or MANUAL to AUTO, without shutting down the alternate, so that takeover is automatic until the setting is next changed. The CEBT command is as follows:

```
MODIFY jobname,CEBT SET TAKEOVER AUTO
```

In both of these examples, you would include takeover commands in the command list tables (CLTs) of these regions to ensure that their related regions are also switched when appropriate.

There is one optional section of code in the overseer program, which is described below.

## Loop or wait detection

The sample overseer program includes some code that you can use to detect possible loops or waits in the active CICS region.

The sample program monitors the CICS task control block (TCB) time stamp. If this remains the same for a period defined by the variable LOOPTM, a message is sent to the console warning of a possible loop or wait. The value of LOOPTM is the number of seconds (wait time) before a loop is suspected, and may need to be changed to suit your requirements and to avoid the detection of “false” loops. It should be set to a value greater than the largest runaway task time interval (as specified on the ICVR system initialization parameter) to avoid detection of user transaction loops.

To include this LOOP WARNING code, set the variable &LOOPWARN to ‘1’ and reassemble the sample.

## Assembling and link-editing the overseer program

The non-specific job control statements required to assemble and link-edit the overseer program are the same as those required for user-replaceable programs, and are described in “Assembling and link-editing user-replaceable programs” on page 436.

The specific link-edit statements that you require are:

```
ORDER DFH$AXRO    this CSECT is in USERTXT(DFH$AXRO)
ORDER DFH$AGCB    this CSECT is in DLOADLIB(DFH$AGCB)
ORDER DFH$ARES    this CSECT is in DLOADLIB(DFH$ARES)
ORDER DFH$ADSP    this CSECT is in DLOADLIB(DFH$ADSP)
INCLUDE USERTXT(DFH$AXRO)
INCLUDE DLOADLIB(DFH$ADSP)
INCLUDE DLOADLIB(DFH$AGCB)
INCLUDE DLOADLIB(DFH$ARES)
ENTRY DFHXRONA
NAME DFH$AXRO(R)
```

If you change the overseer code in any way, note that the libraries SYS1.SDFHMAC and SYS1.AMODGEN are required for the assembly, and that the

link-edit job step requires the entry name DFHXRONA. If you change any of the DSECTs used by the sample overseer program, you should reassemble the four modules.



---

## Part 5. CICS journaling, monitoring, and statistics

### **A general note about user-written programs:**

The following comment applies to all user-written programs mentioned in Part 5 of this book:

- Upon return from any user-written program, CICS must always receive control in primary-space translation mode, with the original contents of all access registers restored, and with all general purpose registers restored (except for those which provide return codes or linkage information).

For information about translation modes, refer to the *IBM ESA/370 Principles of Operation* manual.

---

## Chapter 27. CICS logging and journaling

This chapter is divided into the following sections:

1. “The CICS log manager”
2. “Log stream storage”
3. “Enabling, disabling, and reading journals” on page 711
4. “Structure and content of COMPAT41-format journal records” on page 729
5. “Format of journal records written to SMF” on page 737.

---

### The CICS log manager

The CICS log manager provides facilities for the creation, control, and retrieval of journals during real-time CICS execution. Journals are intended to record, in chronological order, any information that you may later need to reconstruct data or events. For example, you could create journals to act as audit trails; to record database updates, additions, and deletions for backup purposes; or to track transaction activity in the system.

The CICS log manager controls all logging and journaling using services provided by the MVS system logger. The CICS log manager supports:

- The CICS system log
- Forward recovery logs
- Auto-journals for file control and terminal control operations
- User journals.

The MVS system logger provides:

- Media management and archiving
- Log data availability through direct, and sequential, access to log records.

---

### Log stream storage

A log stream is a sequence of data blocks, with each log stream identified by its own log stream identifier—the log stream name (LSN). The CICS system log, forward recovery logs, and user journals map onto specific MVS log streams. CICS forward recovery logs and user journals are referred to as general logs, to distinguish them from system logs.

Each log stream is a sequence of blocks of data, which the MVS system logger internally partitions over three different types of storage:

1. Primary storage, which holds the most recent records written to the log stream. Primary storage can consist of either:
  - a. A structure within a coupling facility. (The use of a coupling facility allows CICS regions in different MVS images to share the same general log streams.) Log data written to the coupling facility is also copied to either a data space or a staging data set.
  - b. A data space in the same MVS image as the system logger. Log data written to the data space is also copied to a staging data set.
2. Secondary storage—when the primary storage for a log stream becomes full, the older records automatically spill into secondary storage, which consists of

data sets managed by the storage management subsystem (SMS). Each log stream, identified by its log stream name (LSN), is written to its own log data sets.

3. Tertiary storage—a form of archive storage, used as specified in your hierarchical storage manager (HSM) policy. Optionally, older records can be migrated to tertiary storage, which can be either DASD data sets or tape volumes.

Figure 71 and Figure 72 on page 711 show the types of storage used by the MVS system logger.

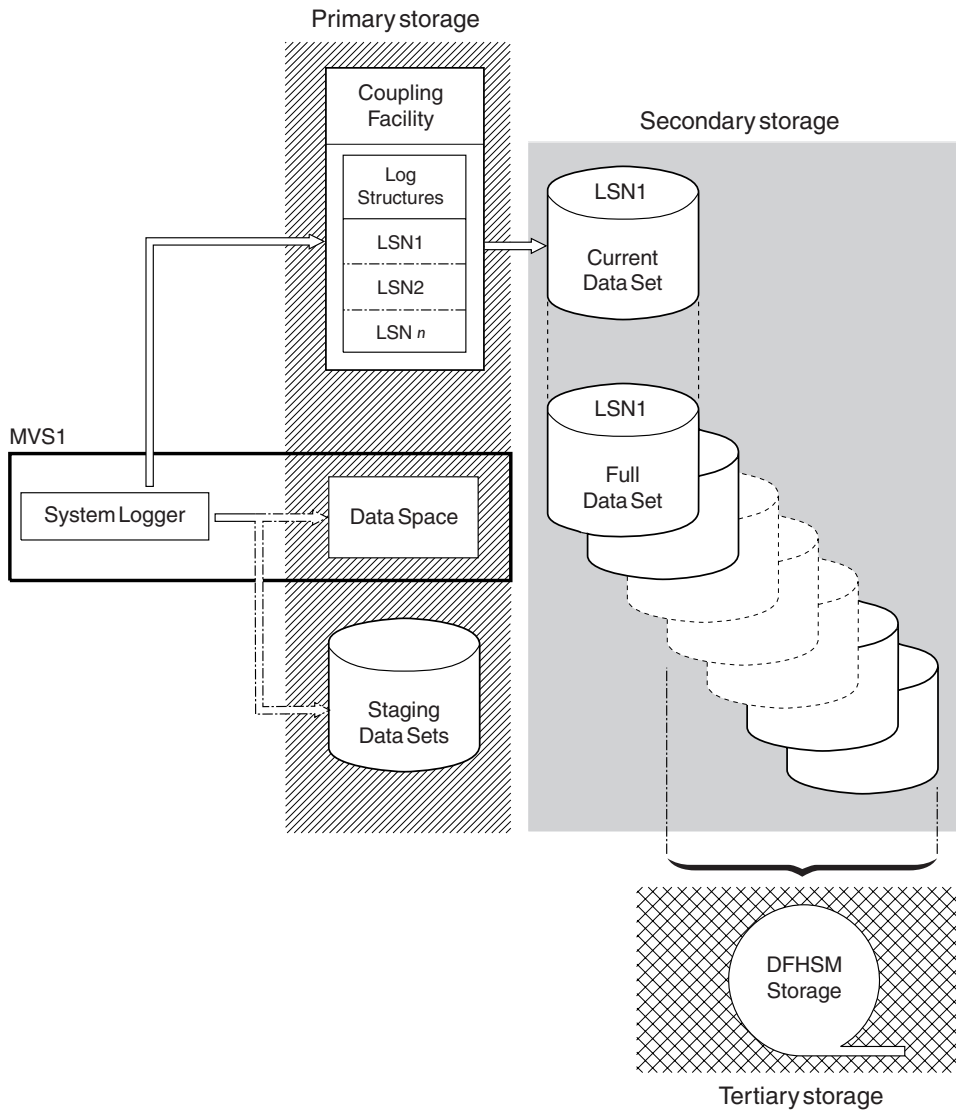

Figure 71. The types of storage used by the MVS system logger. This diagram shows a log stream that uses a coupling facility. Primary storage consists of space in a structure within the CF, and either staging data sets or a data space in the same MVS image as the system logger.

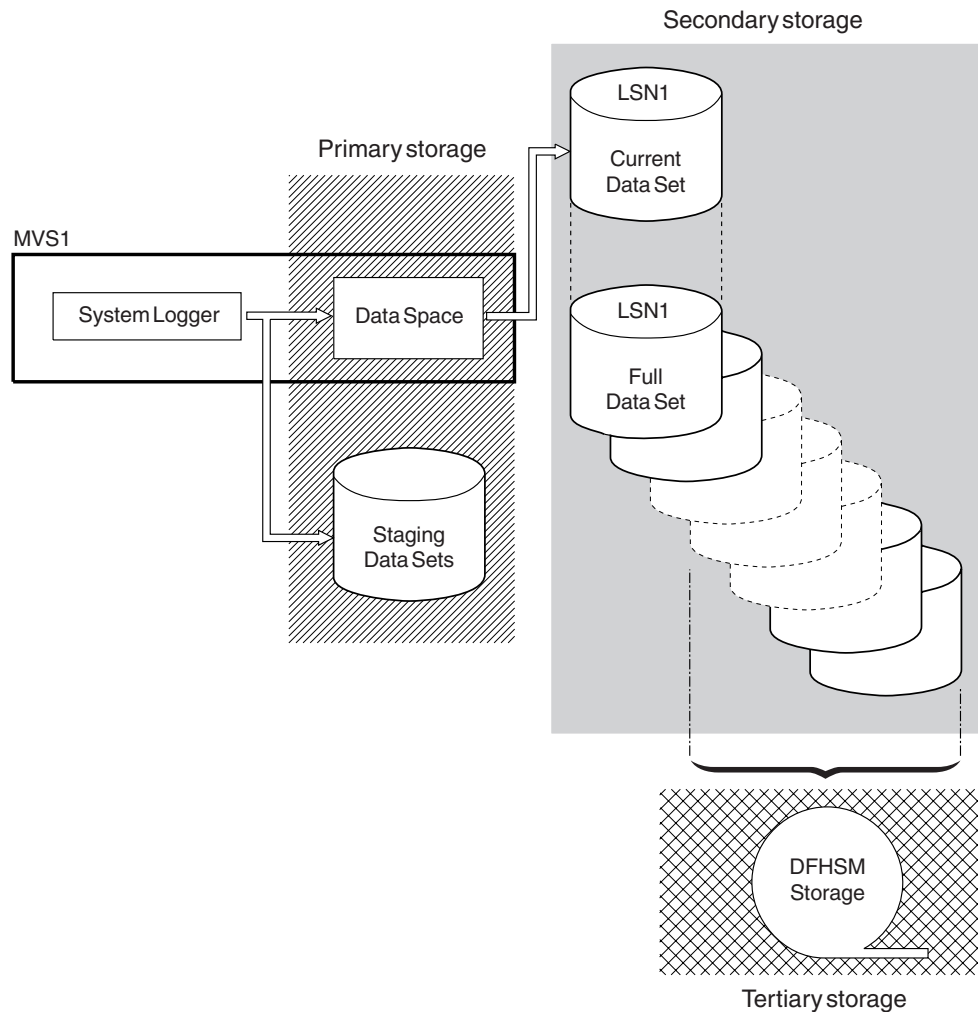

Figure 72. The types of storage used by the MVS system logger. This diagram shows a log stream that uses DASD-only logging. Primary storage consists of a data space in the same MVS image as the system logger, and a single staging data set.

## Enabling, disabling, and reading journals

Journal records are written to a log stream either directly from a user application program, or from a CICS management program on behalf of a user application. Journal records can be written from a user application using the EXEC CICS WRITE JOURNALNAME command. For programming information about the EXEC CICS WRITE JOURNALNAME command, see WRITE JOURNALNAME, in the *CICS Application Programming Reference* manual.

This section describes the commands that you use for enabling and disabling journals, and for reading journals offline.

### Enabling and disabling a journal

To enable or disable a journal from an application program, use the EXEC CICS SET JOURNALNAME command. For programming information about the EXEC CICS SET JOURNALNAME command, see the *CICS System Programming Reference* manual.

## Reading journal records offline

Access to journaled data in log streams is provided through an MVS subsystem interface (SSI), LOGR. Your existing user programs can read the general log streams, providing you specify, in your batch job JCL, the SUBSYS parameter and supporting options on the DD for log streams. By specifying the LOGR subsystem name on the SUBSYS parameter, you enable LOGR to intercept data set open and read requests at the SSI, and convert them into log stream accesses.

Depending on the options specified on the SUBSYS parameter, general log stream journal records are presented either:

- In the record format used at CICS/ESA 4.1 and earlier, for compatibility with older utilities (selected by the COMPAT41 option), or
- In the CICS Transaction Server for z/OS format (introduced at CICS Transaction Server for OS/390, Version 1 Release 1), for newer or upgraded utilities needing to access log record information.

CICS system log records are only available in the CICS Transaction Server for z/OS format, so you must ensure that any utilities that handled system log records in releases prior to CICS Transaction Server for OS/390, Version 1 Release 1 are converted to handle this format.

Journal records can be read offline by user-written programs. You can generate the DSECTs that such programs need by including certain statements in the program code, as follows:

- For records in the CICS Transaction Server for z/OS format on general logs, offline user-written programs can map journal records by including an INCLUDE DFHLGGFD statement. This generates the assembler version of the DSECT.
- For records formatted with the COMPAT41 option, offline user-written programs can map journal records by issuing the DFHJCR CICSYST=YES statement, which results in the DFHJCRDS DSECT being included in the program.

The DSECT thus generated is identical to that obtained for CICS programs by the COPY DFHJCRDS statement, except that the fields are not preceded by a CICS storage accounting area. The DSECT is intended to map journal records directly in the block, rather than in a CICS storage area.

The following section describes the structure of CICS Transaction Server for z/OS-formatted journal records. The structure and content of CICS/ESA 4.1-format journal records are described in “Structure and content of COMPAT41-format journal records” on page 729.

---

## Structure and content of CICS Transaction Server for z/OS format journal records

### SMF records

The following description does not apply to journal records written to an SMF data set. These are described on page “Format of journal records written to SMF” on page 737.

General logs (that is, those containing forward-recovery logs, auto-journals, and user journals) can be presented in the format introduced at CICS Transaction Server for OS/390, Version 1 Release 1. Each journal record in these logs, if presented in the newer format, contains more information than in the equivalent journal record presented in the CICS/ESA 4.1 format.

System logs are always presented in CICS Transaction Server for z/OS format..

Each general log comprises a stream of contiguous blocks of journaled data. Each block comprises a block header followed by a variable number of CICS journal records. Each CICS journal record comprises a record header followed by caller data.

Figure 73 gives a graphical overview of a general log, showing the format of a complete block, and the format of a complete journal record.

The format of the caller data depends on the CICS component that is issuing the journal record, and also on the function being journaled at the time. Thus, for example, the format of caller data in journal records issued by file control differs from that of caller data in journal records issued by FEPI.

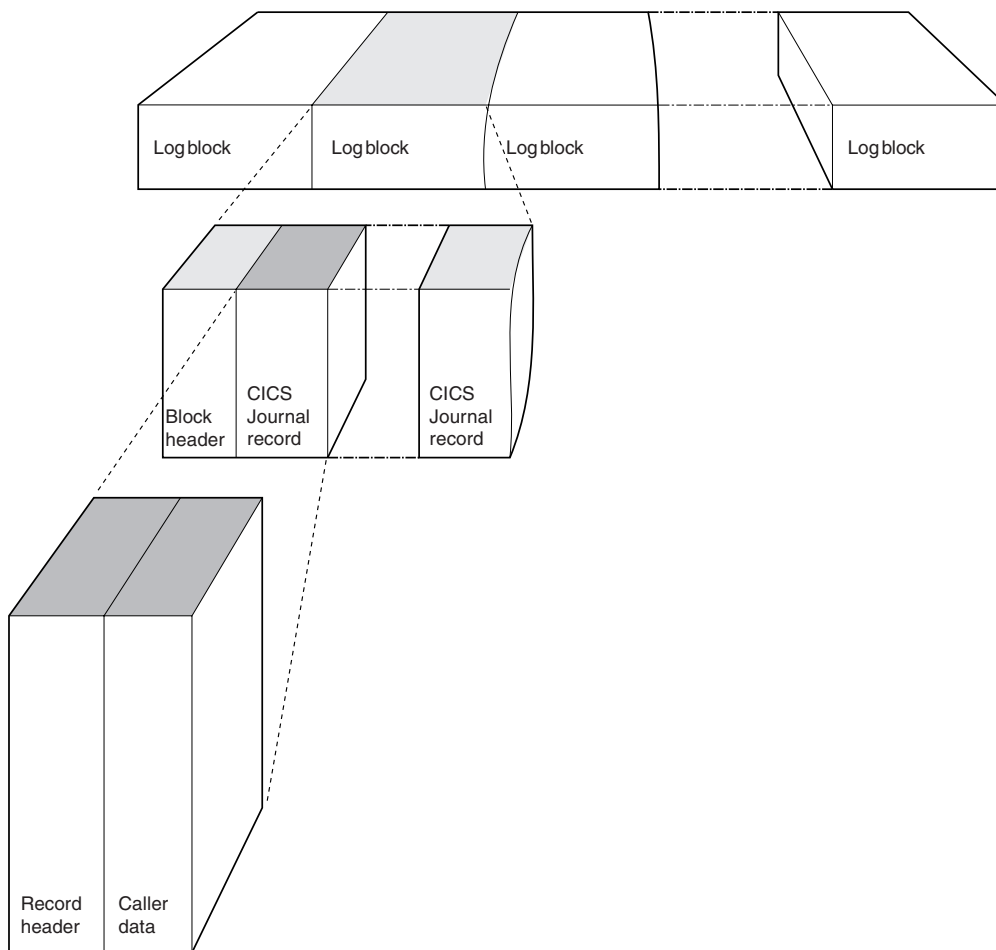
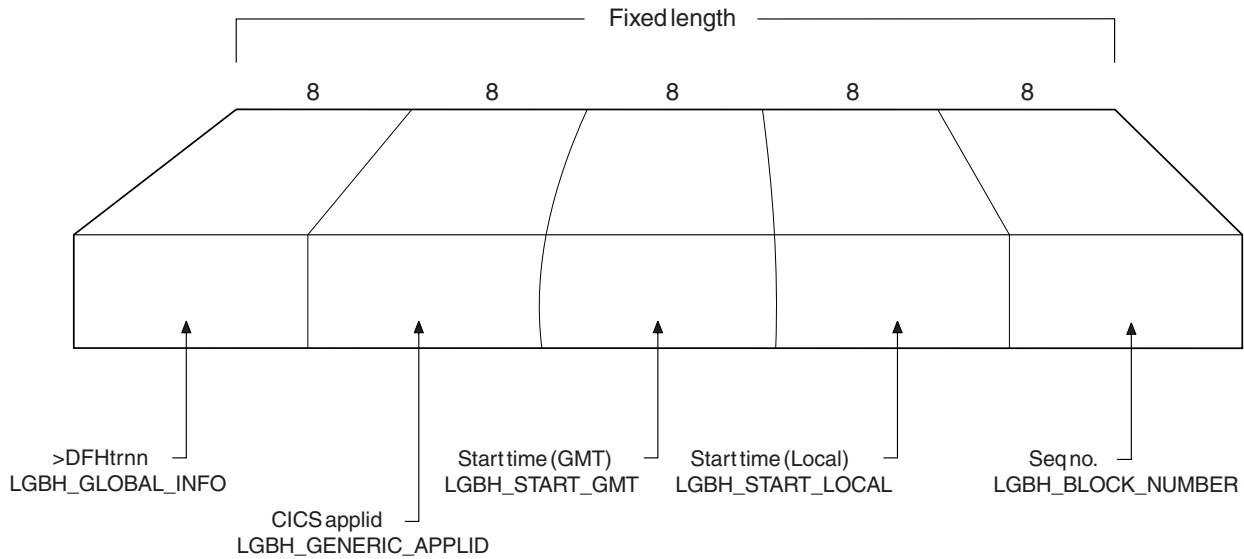

Figure 73. Layout of a general log

## Format of general log block header

The log block header contains information of a general system-wide nature such as the CICS applid writing the journal block. Figure 74 on page 714 shows the format of the log block header.



Where  $t = \text{Log type}$   
 $r = \text{reserved}$   
 $nn = \text{block version number}$

Figure 74. Format of a general log block header

**LGBH\_GLOBAL\_INFO**

8-bytes containing '>DFHtrnn', where:

$t = \text{log type}$   
 $r = \text{reserved}$   
 $nn = \text{block version number}$

**LGBH\_GENERIC\_APPLID**

8-byte CICS applid.

**LGBH\_START\_GMT**

8-byte start time (GMT).

**LGBH\_START\_LOCAL**

8-byte start time (local).

**LGBH\_BLOCK\_NUMBER**

8-byte sequence number.

## Format of general log journal record

The journal record comprises a record header followed by caller data. The record header contains information that describes some of the attributes of the record, such as the time it was written. Figure 75 on page 715 shows the format of the record header.



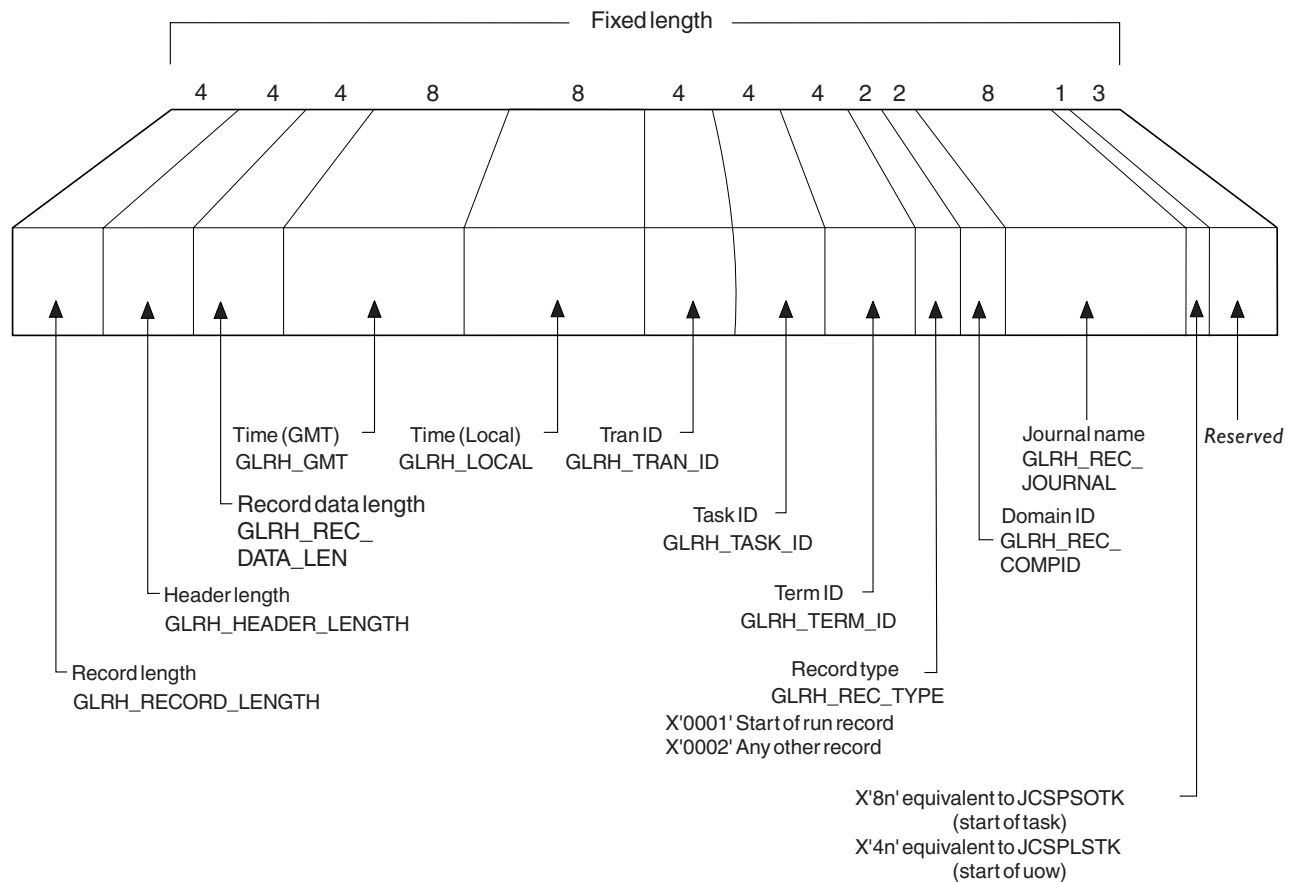

Figure 75. Format of a general log record header

- GLRH\_RECORD\_LENGTH**  
4-byte record length.
- GLRH\_HEADER\_LENGTH**  
4-byte header length.
- GLRH\_REC\_DATA\_LEN**  
4-byte record data length.
- GLRH\_GMT**  
8-byte time (GMT).
- GLRH\_LOCAL**  
8-byte time (local).
- GLRH\_TRAN\_ID**  
4-byte transaction identifier.
- GLRH\_TASK\_ID**  
4-byte task identifier.
- GLRH\_TERM\_ID**  
4-byte terminal identifier.
- GLRH\_REC\_TYPE**  
2-byte record type. Either:  
X'0001' Start of run record  
X'0002' Any other record
- GLRH\_REC\_COMPID**  
2-byte domain identifier.
- GLRH\_REC\_JOURNAL**  
8-byte journal name.

### Start of task indicator

1-byte which may contain:

X'8n' Equivalent to JCSPS0TK (start of task)

X'4n' Equivalent to JCSPSTK (start of UOW)

### Reserved

3-byte reserved field.

The caller data differs depending on the CICS component issuing the record, and on the function being journaled.

## Start-of-run record

When CICS connects to a general log, it writes a start-of-run record to it as the first record for this run of CICS. This record comprises a record header (with the same format as that for any general log journal record) followed by a start-of-run body. The format of the start-of-run record is shown in Figure 76.

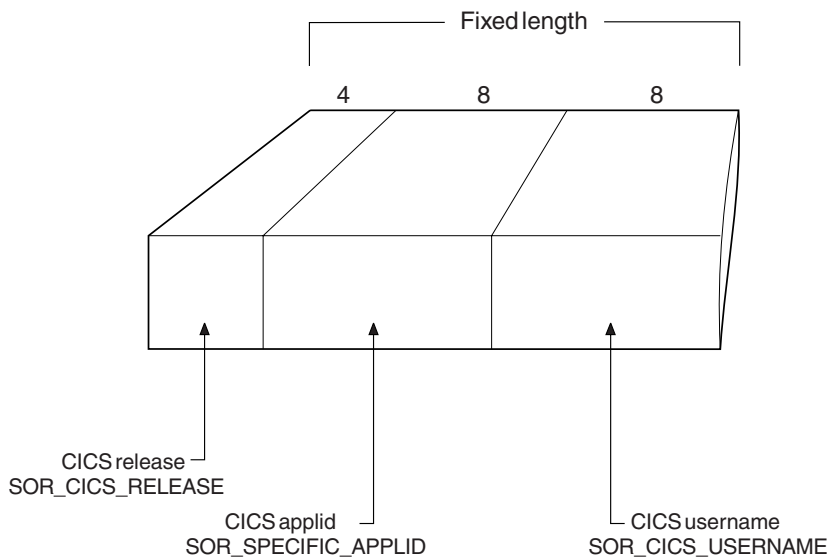

Figure 76. Format of the start-of-run record

#### **SOR\_CICS\_RELEASE**

4-byte CICS release.

#### **SOR\_SPECIFIC\_APPLID**

8-byte CICS applid.

#### **SOR\_CICS\_USERNAME**

8-byte CICS username.

For a start-of-run record, CICS puts the domain identifier “LG” (for “logger”) in the GLRH\_REC\_COMPID field of the record header.

## Format of caller data

Caller data follows the record header.

The format of the caller data part of a general log journal record differs according to the CICS component writing the record, and the function being journaled.

Journal records can be written by any of the following CICS components: the logger, journal control (in the case of a request issued by a user), file control, the front end programming interface (FEPI), and terminal control. The field GLRH\_REC\_COMPID in the record header tells you which component has written the record: LG, UJ, FC, SZ, or TC respectively.

File control adds information to the start of the actual journaled data, and this is described in “Caller data written by file control.” The other components (journal control, FEPI, and terminal control) do not add any further information to the journaled data.

If the record has been written by the CICS API, the caller data section starts with an API user header, the format of which is shown in Figure 77.

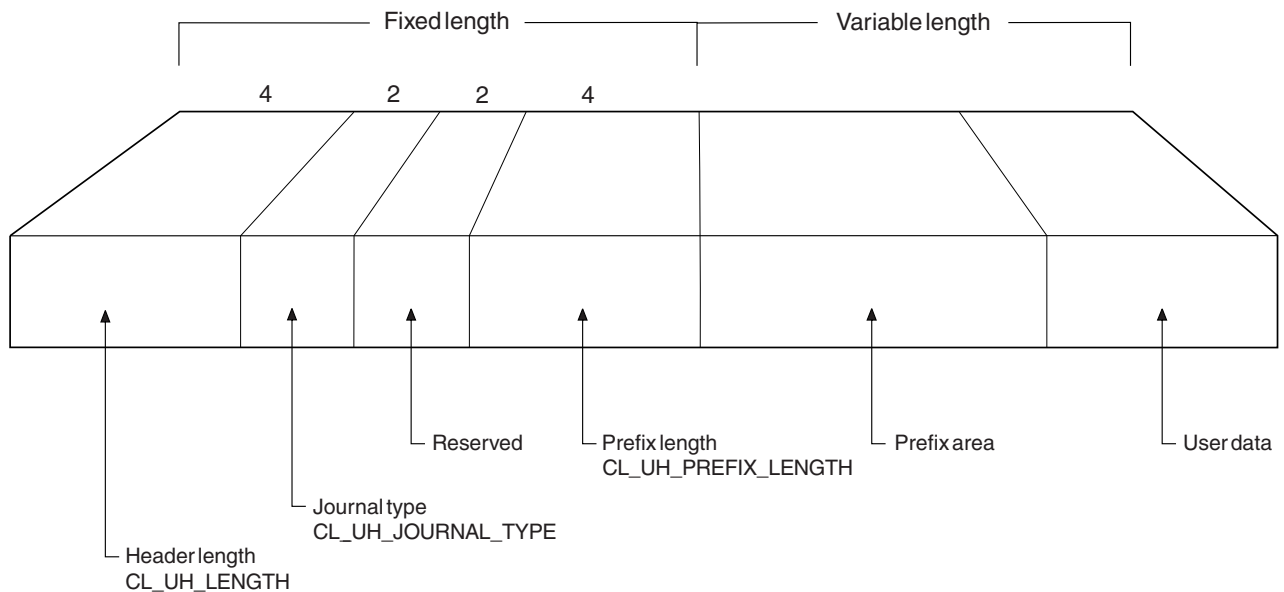

Figure 77. Format of the API user header

**CL\_UH\_LENGTH**  
4-byte header length.

**CL\_UH\_JOURNAL\_TYPE**  
2-byte journal type.

**Reserved**  
2-byte reserved field.

**CL\_UH\_PREFIX\_LENGTH**  
4-byte prefix length.

**Prefix** Variable-length prefix area.

**User data**  
Variable-length user data.

### Caller data written by file control

The file log and journal block (FLJB) describes the caller data that file control writes as part of its journal records. The copybook DFHFCLGD defines the FLJB DSECT.

There are two sections in the FLJB: the first section contains data that is applicable to all journal records written by file control; the second section contains information specific to the record type. Both sections are of fixed length.

Some records have a third and fourth section which are of variable length.

Table 38 outlines the sections in a journal record written by file control.

Table 38. FLJB sections in journal records issued by file control

Record type	First section	Second section	Third section	Fourth section
Read-only Read-update Write-update Write-add Write-add complete	FLJB_GENERAL_DATA	FLJB_COMMON_DATA	FLJB_CD_KEY	FLJB_CD_DATA
Write delete	FLJB_GENERAL_DATA	FLJB_WRITE_DELETE_DATA	FLJB_WDD_BASE_KEY	FLJB_WDD_PATH_KEY
File close	FLJB_GENERAL_DATA	FLJB_FILE_CLOSE_DATA	None	None
Tie-up	FLJB_GENERAL_DATA	FLJB_TIE_UP_RECORD_DATA	None	None

A description of each of the structures, and the sections within them, now follows:

### Read-only, read-update, write-update, write-add, write-add complete record types

There are four sections in the journal records written for read-only, read-update, write-update, write-add, and write-add complete record types:

- The FLJB\_GENERAL\_DATA section,
- The FLJB\_COMMON\_DATA section, and
- The caller data image sections which consist of the FLJB\_CD\_KEY (the length of which is given in FLJB\_COMMON\_DATA) and the FLJB\_CD\_DATA section. The FLJB\_CD\_DATA section (the length of which is given in FLJB\_COMMON\_DATA) contains the image of the caller data.

The format of such a record written for these record types is shown in Figure 78.

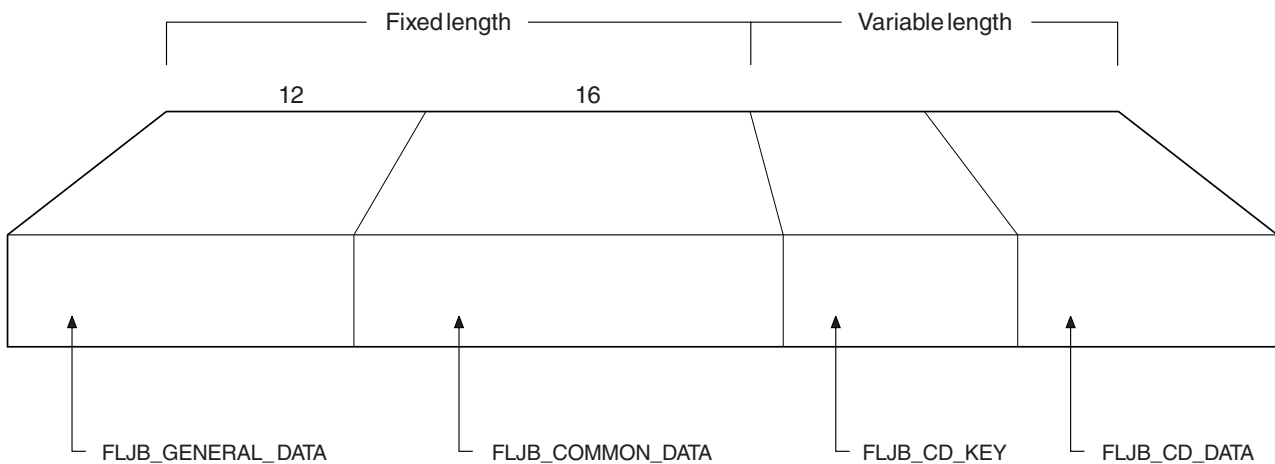

Figure 78. Layout of record written for read-only, read-update, write-update, write-add, and write-add-complete record types

**FLJB\_GENERAL\_DATA**

12-byte general data.

**FLJB\_COMMON\_DATA**

16-byte common data.

**FLJB\_CD\_KEY**

Variable-length caller data key.

**FLJB\_CD\_DATA**

Variable-length caller data.

The format of the FLJB\_GENERAL\_DATA section is shown in Figure 79.

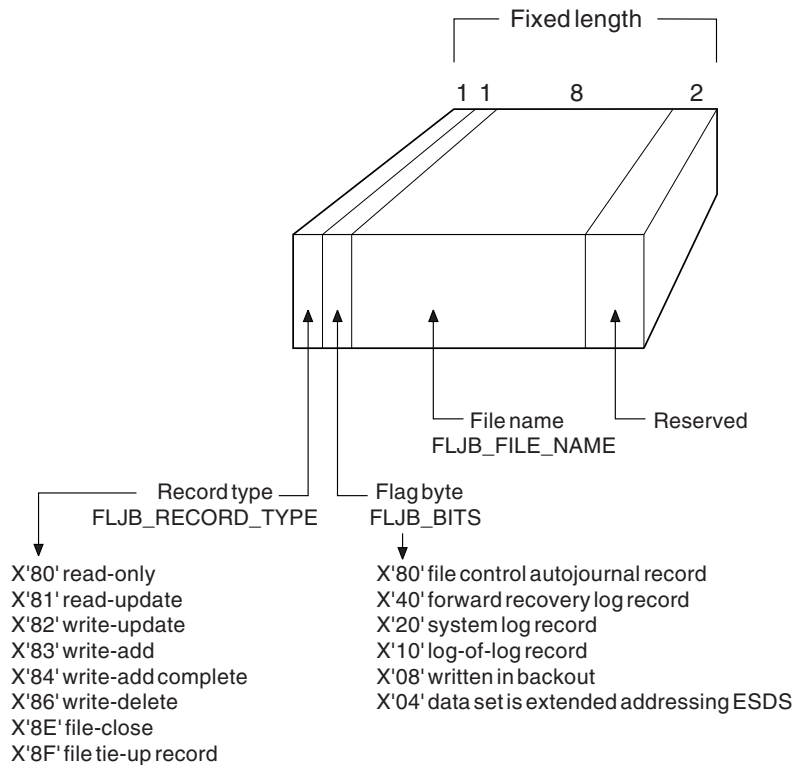

Figure 79. Format of FLJB\_GENERAL\_DATA section

**FLJB\_RECORD\_TYPE**

1-byte record type:

X'80'	Readonly
X'81'	Read update
X'82'	Write update
X'83'	Write add
X'84'	Write add complete
X'86'	Write delete
X'8E'	File close
X'8F'	File tie-up record

**FLJB\_BITS**

1-byte flag field:

X'80'	File control autojournal record
X'40'	Forward recovery log record
X'20'	System log record
X'10'	Log-of-log record
X'08'	Written in backout
X'04'	Data set is extended addressing ESDS

**FLJB\_FILE\_NAME**

8-byte file name.

**Reserved**

2-byte reserved field.

The format of the FLJB\_COMMON\_DATA section is shown in Figure 80.

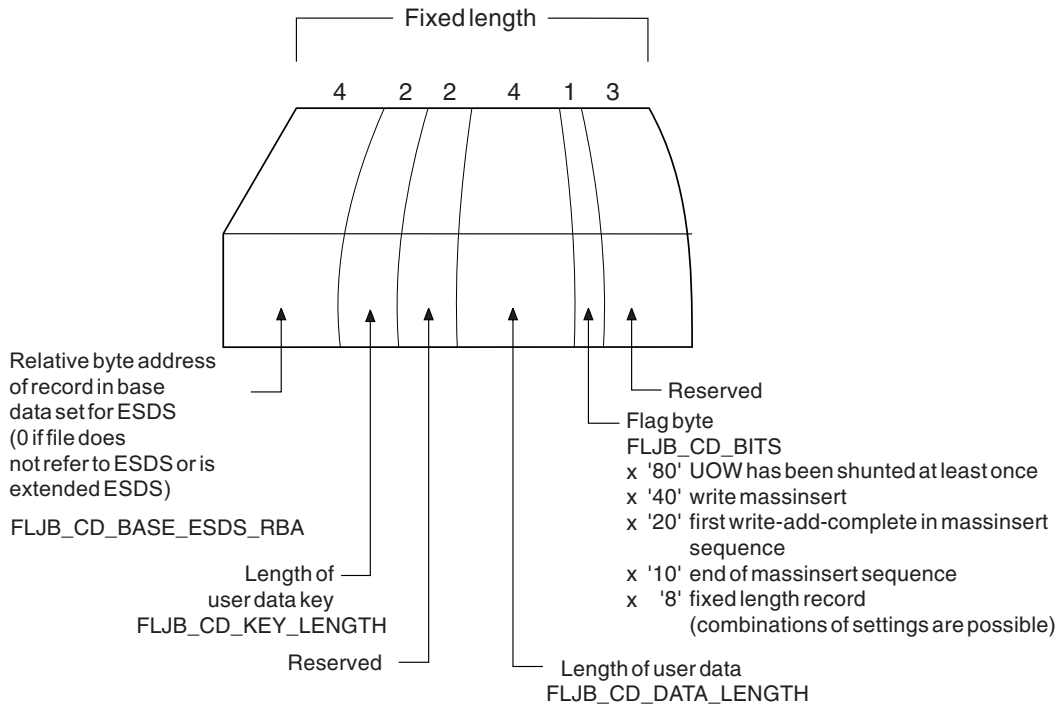

Figure 80. Format of FLJB\_COMMON\_DATA section

**FLJB\_CD\_BASE\_ESDS\_RBA**

4-byte relative byte address of record in base data set for ESDS (0 if file does not refer to ESDS, or if is an extended addressing ESDS).

**FLJB\_CD\_KEY\_LENGTH**

2-byte length of user data key. (The key length is 4 for an RRDS, a VRRDS, or a standard ESDS; 8 for an extended addressing ESDS.)

**Reserved**

2-byte reserved field.

**FLJB\_CD\_DATA\_LENGTH**

4-byte length of user data.

**FLJB\_CD\_BITS**

1-byte flag field:

X'80'	UOW has been shunted at least once
X'40'	Write massinsert
X'20'	First write-add-complete in massinsert sequence
X'10'	End of massinsert sequence
X'8'	Fixed length record

Combinations of settings are possible.

**Reserved**

3-byte reserved field.

## Write-delete record types

There are four sections in the journal records written for write-delete record types:

- The FLJB\_GENERAL\_DATA section,
- The FLJB\_WRITE\_DELETE\_DATA section, and
- The two caller data image sections, which consist of:
  - FLJB\_WDD\_BASE\_KEY (the length of which is given by FLJB\_WDD\_BASE\_KEY\_LENGTH in FLJB\_WRITE\_DELETE\_DATA)
  - FLJB\_WDD\_PATH\_KEY (the length of which is given by FLJB\_WDD\_PATH\_KEY\_LENGTH in FLJB\_WRITE\_DELETE\_DATA).

These sections contain the image of the caller data as the base key, and, if the data set is a path, the path.

The format of such a record written for write-delete record types is shown in Figure 81.

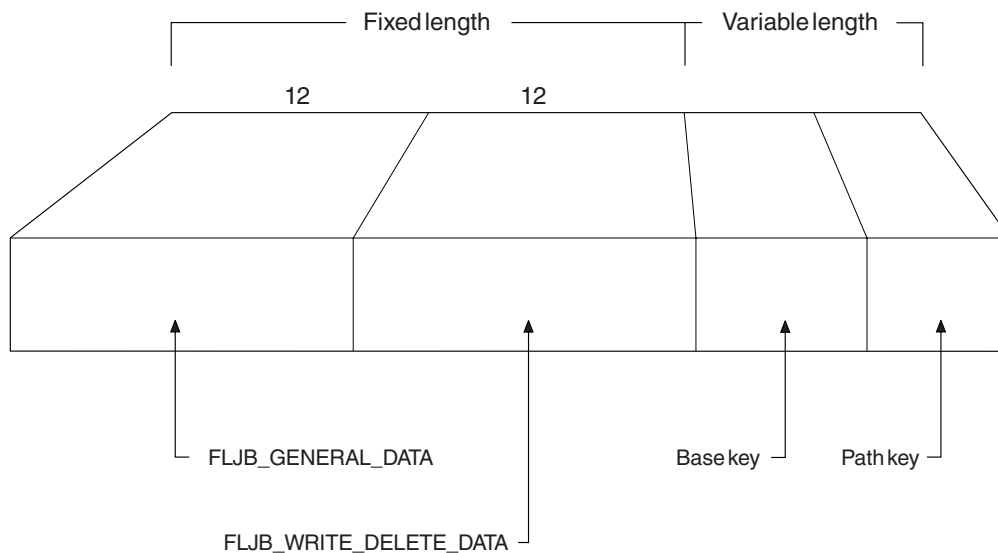

Figure 81. Layout of record written for write-delete record types

### **FLJB\_GENERAL\_DATA**

12-byte general data section.

### **FLJB\_WRITE\_DELETE\_DATA**

12-byte write-delete data section.

### **FLJB\_WDD\_BASE\_KEY**

Variable-length base key.

### **FLJB\_WDD\_PATH\_KEY**

Variable-length path key.

See Figure 79 on page 719 for the format of the FLJB\_GENERAL\_DATA section.

The format of the FLJB\_WRITE\_DELETE\_DATA section is shown in Figure 82 on page 722.

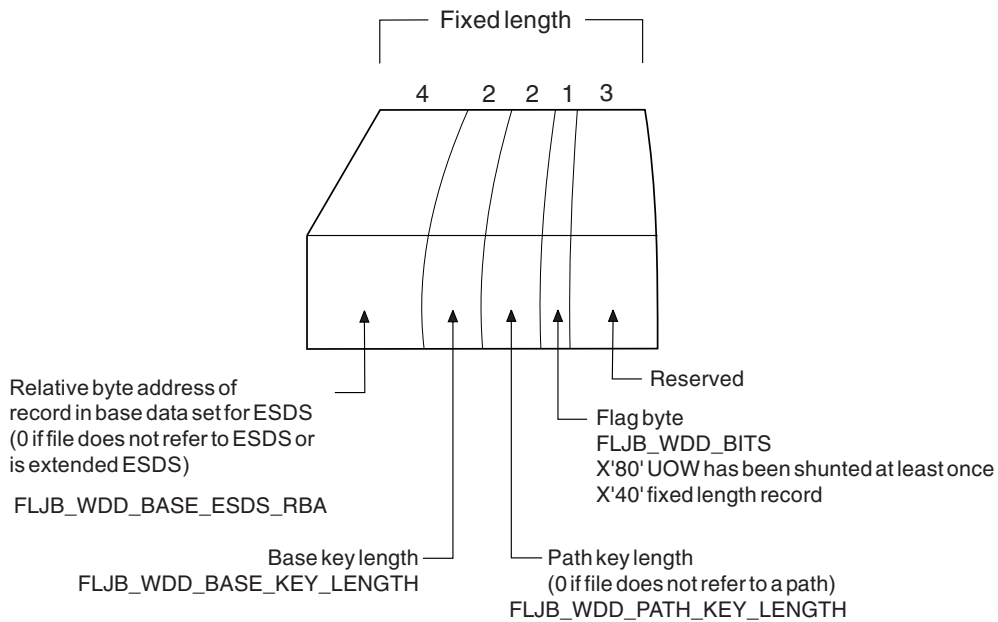

Figure 82. Format of the FLJB\_WRITE\_DELETE\_DATA section

#### FLJB\_WDD\_BASE\_ESDS\_RBA

4-byte relative byte address of record in base data set for ESDS (0 if file does not refer to ESDS, or if it is an extended addressing ESDS).

#### FLJB\_WDD\_BASE\_KEY\_LENGTH

2-byte base key length. (The key length is 4 for an RRDS, a VRRDS, or a standard ESDS; 8 for an extended addressing ESDS.)

#### FLJB\_WDD\_PATH\_KEY\_LENGTH

2-byte path key length (0 if file does not refer to a path).

#### FLJB\_WDD\_BITS

1-byte flag field:

X'80' UOW has been shunted at least once

X'40' Fixed-length record

#### Reserved

3-byte reserved field.

### File-close record types

There are two sections in the journal records written for file-close record types:

- The FLJB\_GENERAL\_DATA section
- The FLJB\_CLOSE\_DATA section.

The format of such a record written for file-close record types is shown in Figure 83 on page 723.



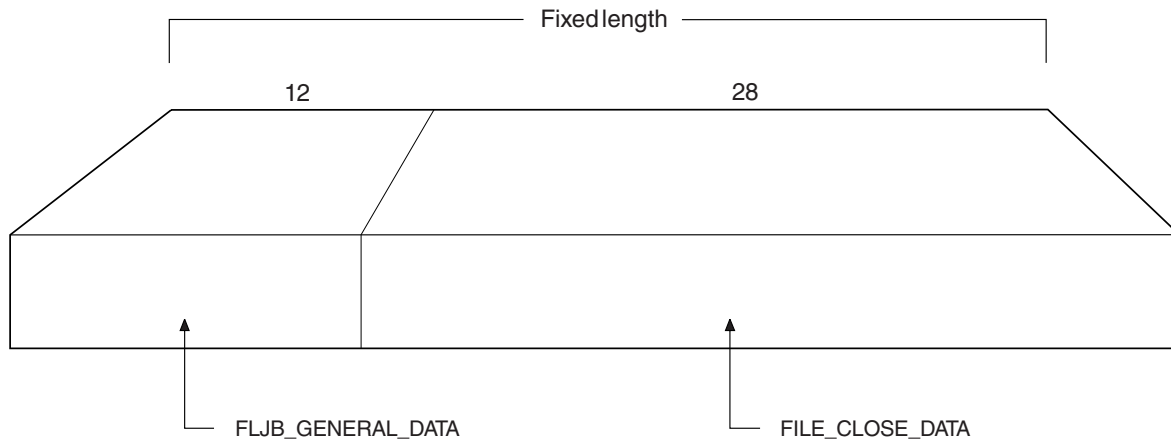

Figure 83. Layout of record written for file-close record types

**FLJB\_GENERAL\_DATA**  
12-byte general data section.  
**FLJB\_CLOSE\_DATA**  
28-byte close data section.

See Figure 79 on page 719 for the format of the FLJB\_GENERAL\_DATA section.

The format of the FLJB\_CLOSE\_DATA section is shown in Figure 84.

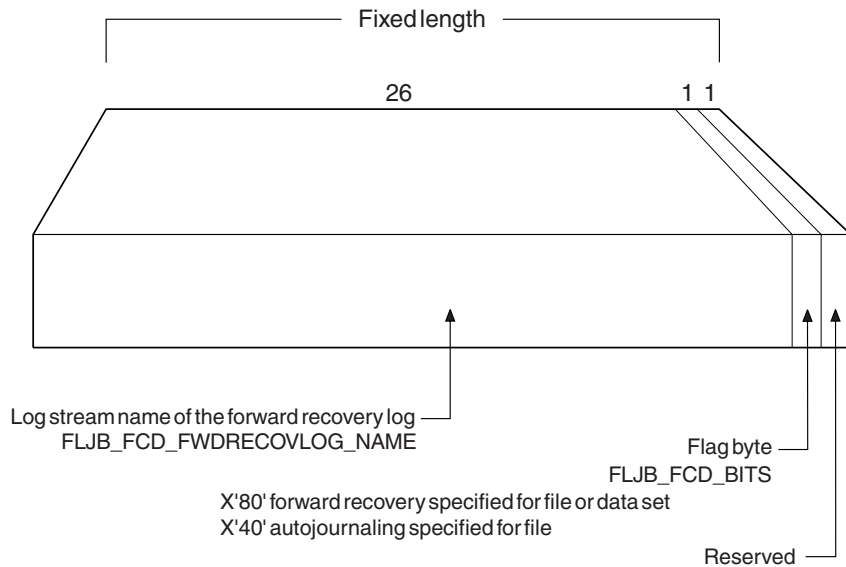

Figure 84. Format of the FILE\_CLOSE\_DATA section

**FLJB\_FCD\_FWDRECOVLOG\_NAME**  
26-byte log stream name of the forward recovery log.  
**FLJB\_FCD\_BITS**  
1-byte flag field:  
X'80' Forward recovery specified for file or data set  
X'40' Autojournaling specified for file  
**Reserved**  
1-byte reserved field.

## Tie-up record types

There are two sections in the journal records written for tie-up record types:

- The FLJB\_GENERAL\_DATA section
- The TIE\_UP\_RECORD\_DATA section.

The format of such a record written for tie-up record types is shown in Figure 85.

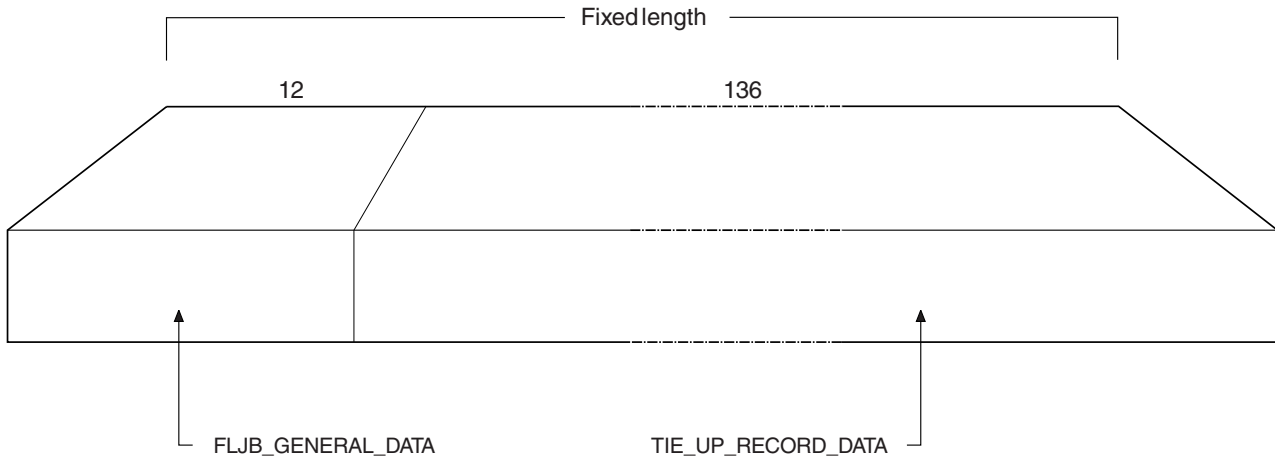

Figure 85. Layout of record written for tie-up record types

### **FLJB\_GENERAL\_DATA**

12-byte general data.

### **TIE\_UP\_RECORD\_DATA**

136-byte tie-up record data.

See Figure 79 on page 719 for the format of the FLJB\_GENERAL\_DATA section.

The format of the TIE\_UP\_RECORD\_DATA section is shown in Figure 86 on page 725.

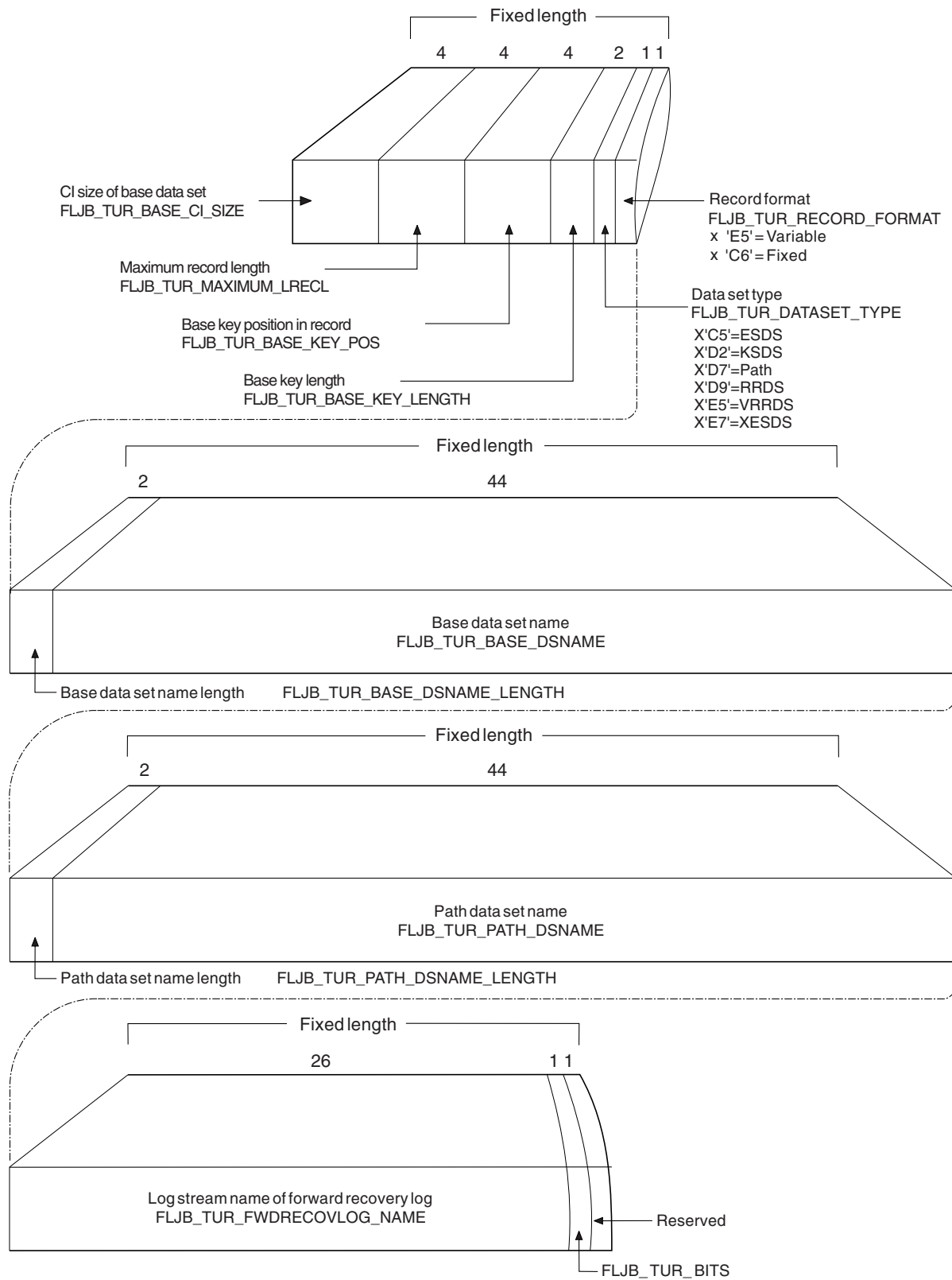

Figure 86. Format of TIE\_UP\_RECORD\_DATA section

**FLJB\_TUR\_BASE\_CI\_SIZE**  
4-byte CI size of base data set.

**FLJB\_TUR\_MAXIMUM\_LRECL**

4-byte maximum record length.

**FLJB\_TUR\_BASE\_KEY\_POSITION**

4-byte base key position in record.

**FLJB\_TUR\_BASE\_KEY\_LENGTH**

2-byte base key length.

**FLJB\_TUR\_DATASET\_TYPE**

1-byte data set type:

X'C5'	Standard ESDS
X'D2'	KSDS
X'D7'	Path
X'D9'	RRDS
X'E5'	VRRDS
X'E7'	Extended ESDS

**FLJB\_TUR\_RECORD\_FORMAT**

1-byte record format:

X'E5'	Variable
X'C6'	Fixed

**FLJB\_TUR\_BASE\_DSNAME\_LENGTH**

2-byte length of base data set name.

**FLJB\_TUR\_BASE\_DSNAME**

44-byte base data set name.

**FLJB\_TUR\_PATH\_DSNAME\_LENGTH**

2-byte length of path data set name.

**FLJB\_TUR\_PATH\_DSNAME**

44-byte path data set name.

**FLJB\_TUR\_FWDRECOVLOG\_NAME**

26-byte log stream name of forward recovery log.

**FLJB\_TUR\_BITS**

1-byte flag field.

**Reserved**

1-byte reserved field.

**Note:** The format of caller data in journal records written by file control in RLS mode is identical to that in journal records written by file control in non-RLS mode except for FLJB\_TUR\_BITS where a value of X'80' indicates RLS-access.

**Terminal control prefix data**

CICS terminal control (TC) writes journal records to track the messages it issues. Each TC journal record contains a prefix area, which lies in the position of the prefix area in the API user header. For LU6.1-related records only, the prefix area contains the VTAM physical sequence numbers at syncpoint time; for all other TC journal records, it contains binary zeros. The format of the TC prefix area is shown in Figure 87 on page 727.

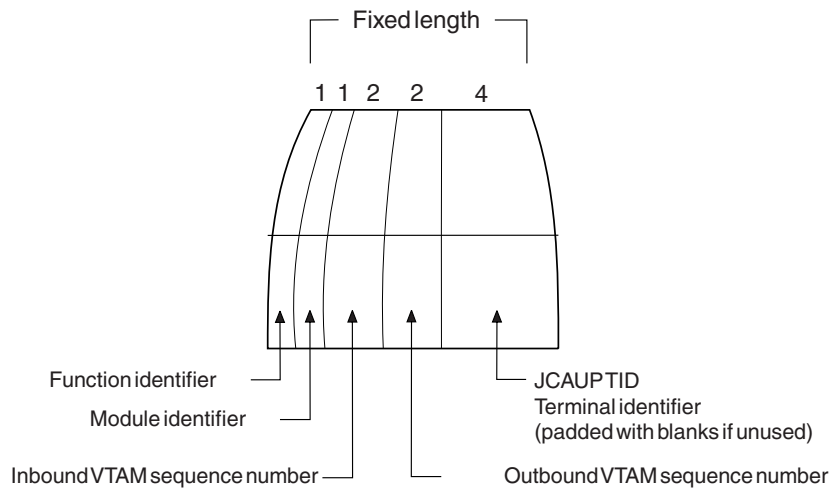

Figure 87. Format of the terminal control prefix area

**Function ID**

1-byte function identifier.

**Module ID**

1-byte module identifier.

**Inbound VTAM SN**

2-byte inbound VTAM sequence number.

**Outbound VTAM SN**

2-byte outbound VTAM sequence number.

**JCAUP TID**

4-byte terminal identifier (padded with blanks if unused).

**FEPI prefix data**

Each FEPI journal record contains a prefix area that allows you to identify the FEPI conversation for which the data was journaled. This prefix area lies in the position of the prefix area in the API user header. Its format is shown in Figure 88 on page 728.

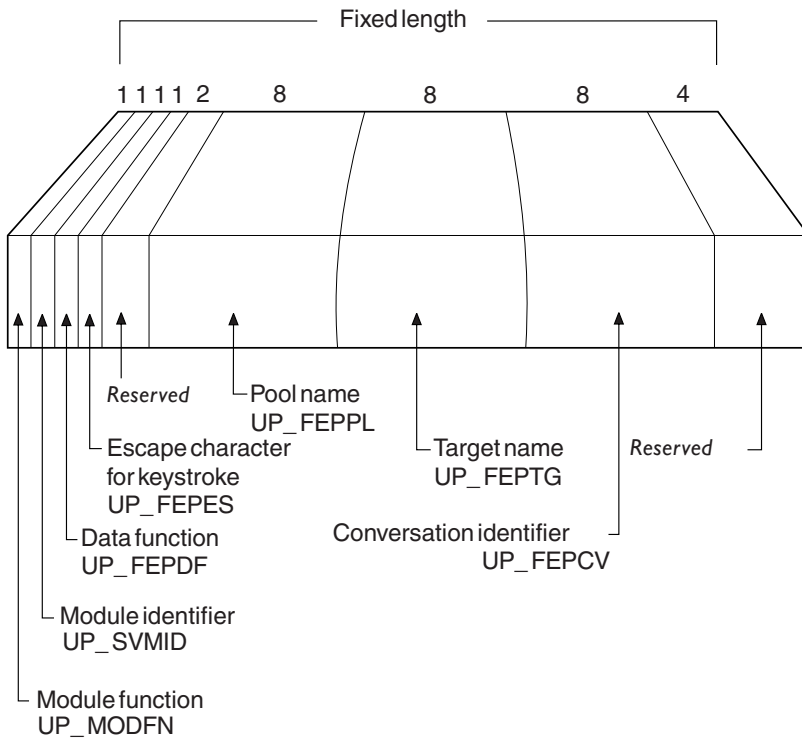

Figure 88. Format of the FEPI prefix area

- UP\_MODFN**  
1-byte module function
- UP\_SVMID**  
1-byte module identifier
- UP\_FEPDF**  
1-byte data function
- UP\_FEPES**  
1-byte escape character for keystroke
- Reserved**  
2-byte reserved field
- UP\_FEPPL**  
8-byte pool name
- UP\_FEPTG**  
8-byte target name
- UP\_FEPCV**  
8-byte conversation identifier
- Reserved**  
4-byte reserved field

## Structure and content of COMPAT41-format journal records

### SMF records

The following description does not apply to journal records written to an SMF data set. These are described on page “Format of journal records written to SMF” on page 737.

CICS allows you to format journal records so that they are presented in the format used at CICS/ESA 4.1. Use the COMPAT41 option on the SUBSYS=(LOGR...) step of your JCL.

Within the data presented, certain fields are not presented at CICS Transaction Server for z/OS. They appear as X'00' in the formatted output. These fields are:

Table 39. Fields formatted as X'00'

JCLRJFID	JCLRTBAL	JCSPEMER
JCLRVCDD	JCRBB	JCSPMIDT
JCLRVSND	JCSPFS	JCSPRRIF
JCLRLBW	JCSPDSP	

Each general log comprises a stream of contiguous blocks of journaled data. Each block comprises a journal control label header followed by a variable number of CICS journal records. Each CICS journal record comprises a system header, system prefix, user prefix, and journaled data.

A graphical overview of the format of a general log, showing the format of a complete block, is shown in Figure 89.

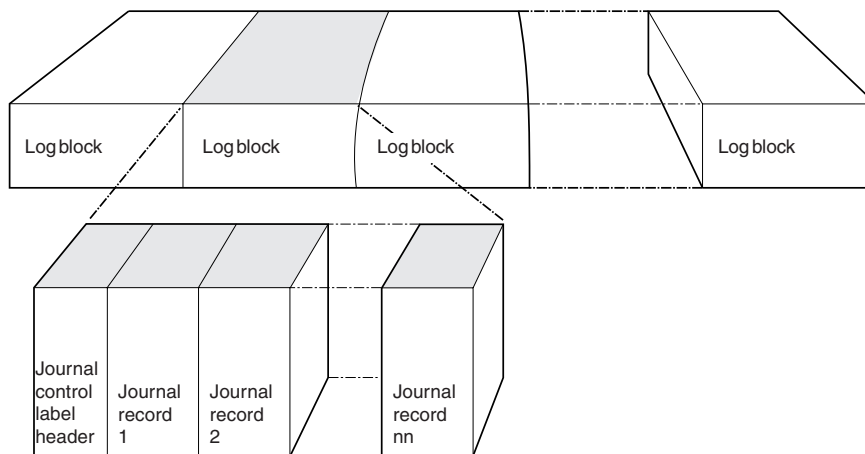

Figure 89. Format of general log formatted using the COMPAT41 option

### Format of COMPAT41 journal control label header

Each log block starts with a journal control label header. There is one journal control label header per log block. It is 42 bytes long, and comprises a length field, label header, and label prefix. The format of the journal control label header is shown in Figure 90 on page 730.

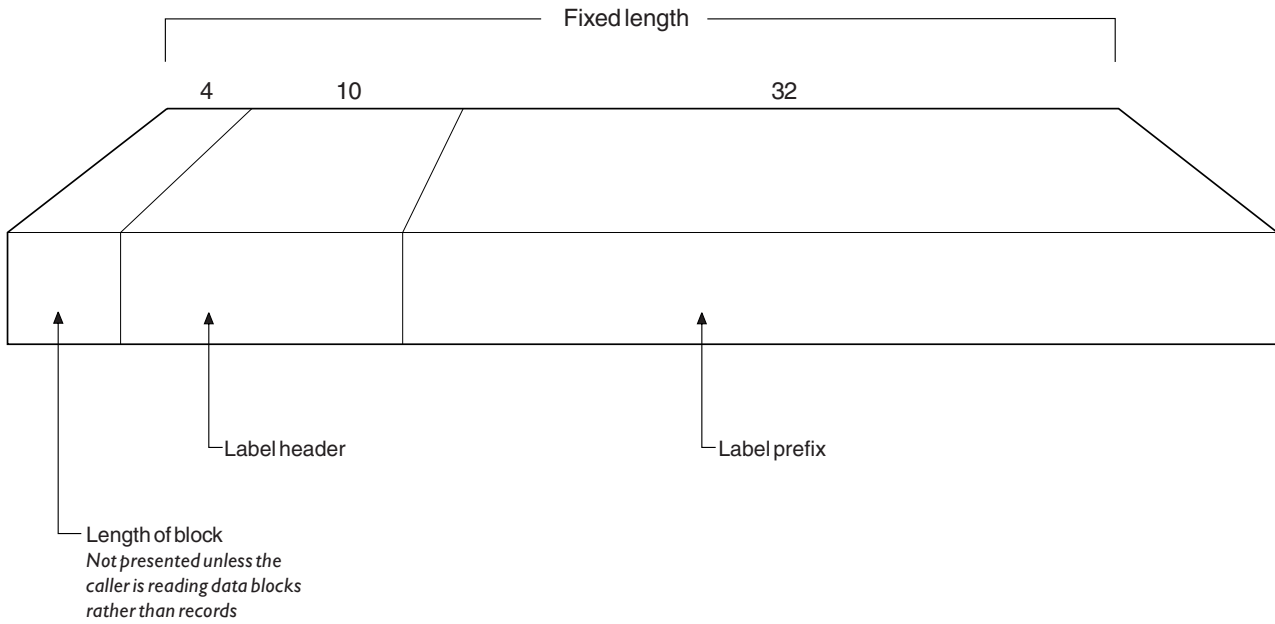

Figure 90. Format of journal control label header

The label header part of the journal control label header is 10 bytes long, and its format is shown in Figure 91.

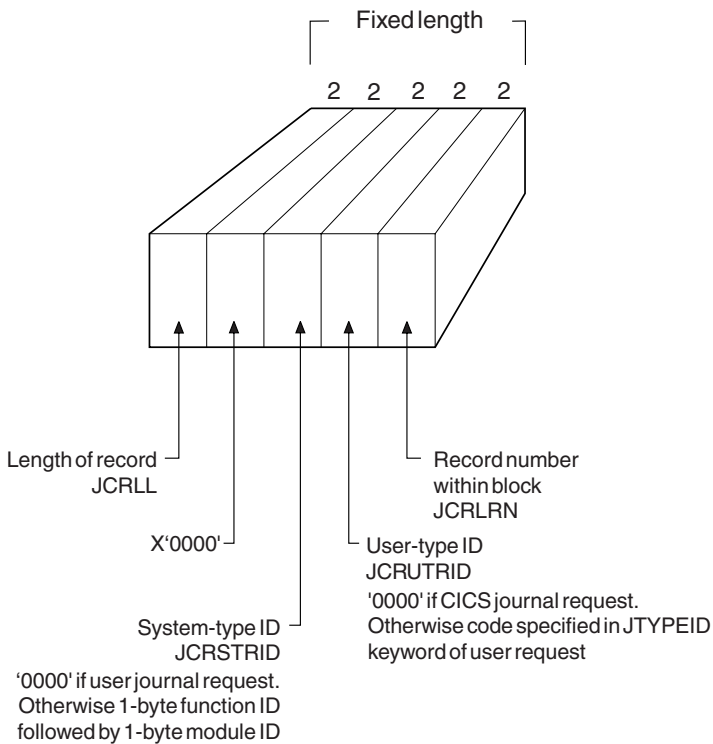

Figure 91. Format of label header part of journal control label header

**JCRLL** 2-byte length of record.  
**X'0000'** 2-bytes containing X'0000'.



**JCRSTRID**

2-byte system-type identifier. For a user journal request, this is X'0000'. Otherwise, it consists of a 1-byte function ID followed by a 1-byte module ID.

**JCRUTRID**

2-byte user-type identifier. For a CICS journal request, this is X'0000'. Otherwise, it contains the code specified by the JTYPEID keyword of the user request.

**JCRLRN**

2-byte record number within the block.

The label prefix part of the journal control label header is 32 bytes long, and its format is shown in Figure 92.

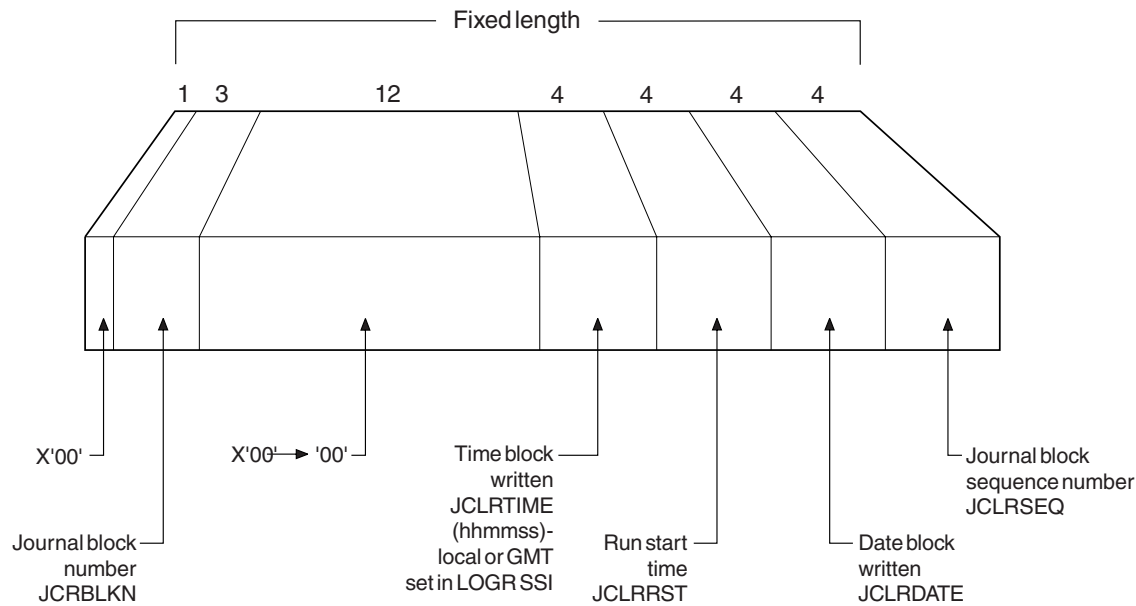

Figure 92. Format of label prefix part of journal control label header

**X'00'** 1-byte containing X'00'.

**JCRBLKN**

3-byte journal block number.

**X'00's** 12-bytes each containing X'00'.

**JCLRTIME**

4-bytes containing the time the block was written, in hhmmss format. (Local or GMT set in LOGR SSI.)

**JCLRRST**

4-bytes containing the run start time.

**JCLRDATE**

4-bytes containing the date the block was written.

**JCLRSEQ**

4-byte journal block sequence number.

## Format of journal record

Each CICS journal record comprises a system header, system prefix, user prefix, and journaled data. The format of a journal record is shown in Figure 93 on page 732.

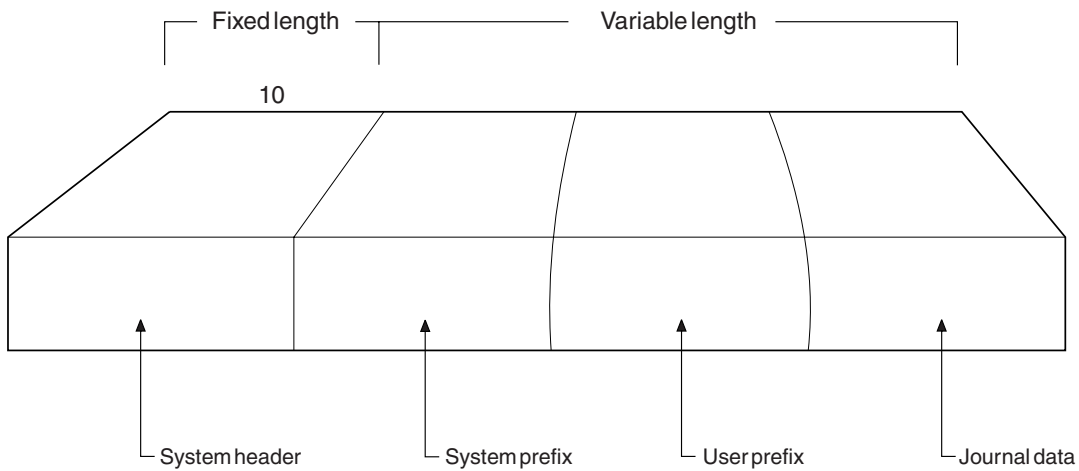

Figure 93. Format of COMPAT41 journal record

The system header is 10 bytes long. Its format is shown in Figure 94.

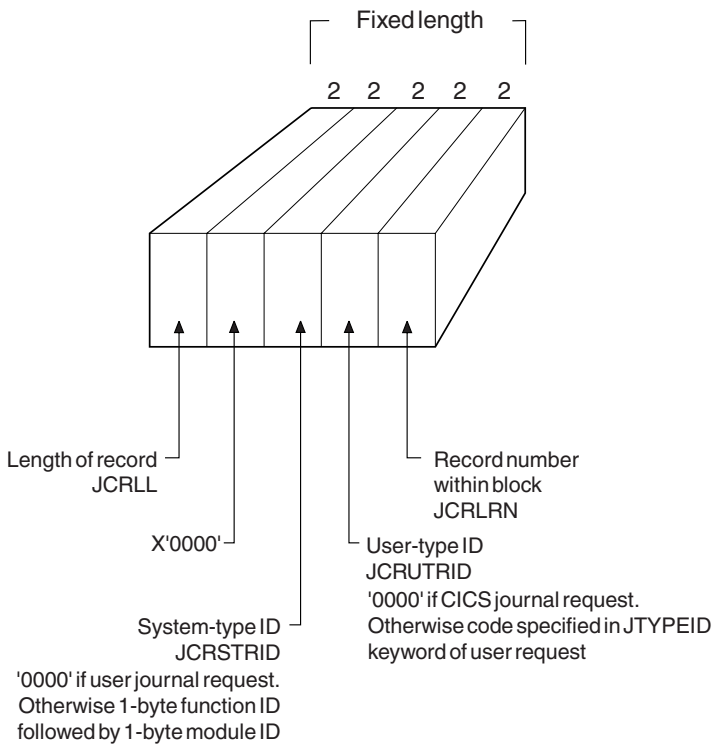

Figure 94. Format of the system header

**JCRL**

2-byte length of record.

**X'0000'**

2-bytes containing X'0000'.

**JCRSTRID**

2-byte system-type identifier. For a user journal request, this is X'0000'. Otherwise, it consists of a 1-byte function ID followed by a 1-byte module ID.

### JCRUTRID

2-byte user-type identifier. For a CICS journal request, this is X'0000'. Otherwise, it contains the code specified by the JTYPEID keyword of the user request.

### JCRLRN

2-byte record number within the block.

The field JCRSTRID (the system-type ID) and the field JCRUTRID (the user-type ID) in the system header allow you to distinguish those journal records output by CICS (by such components as terminal control), from those issued by direct user requests.

For CICS journal requests, JCRUTRID contains binary zeros, and JCRSTRID contains a 1-byte function code followed by a 1-byte module code. The function code tells you which function was being journaled, and the module code shows which module caused the record to be written. Valid settings of these codes are contained in the member DFHFMIDS of the CICS assembler-language macro library. Figure 97 on page 736 shows the valid function identifiers of those CICS components that issue journal requests. Figure 98 on page 737 shows the valid module identifiers.

For user journal requests, JCRSTRID always contains binary zeros, and JCRUTRID contains the 2-byte hexadecimal code specified by the JTYPEID keyword of the WRITE JOURNALNAME request in the application program.

The system prefix is 20 bytes long. Its format is shown in Figure 95.

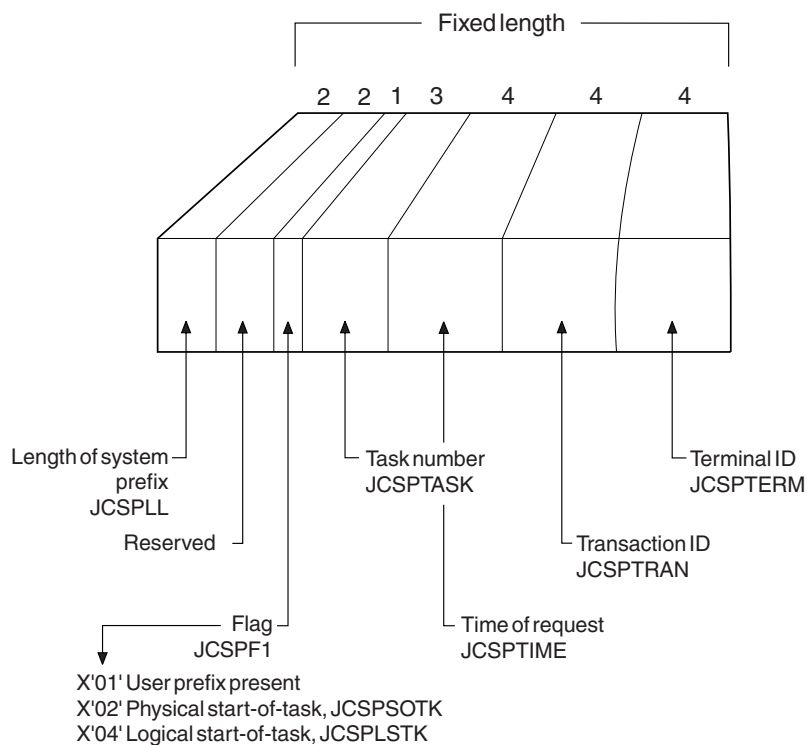

Figure 95. Format of the system prefix

### JCSPLL

2-byte length of the system prefix.

**Reserved**

2-byte reserved field.

**JCSPF1**

1-byte flag field:

X'01' User prefix present  
 X'02' Physical start-of-task, JCSPS0TK  
 X'04' Logical start-of-task, JCSPSTK

**JCSPTASK**

3-byte task number.

**JCSPTIME**

4-byte time of request.

**JCSPTRAN**

4-byte transaction identifier.

**JCSPTERM**

4-byte terminal identifier.

For some CICS journal requests, additional data is included in the system prefix to identify more specifically the originator of the request. This extra data follows the common fields of the system prefix, and is usually variable in length; hence the need for the length field JCSPLL at the start of the system prefix. All the following have their own prefix layout, and these are described, for the purposes of diagnosis and recovery, in the *CICS Data Areas* manual.

The user prefix is a variable length area. It is present if this record has been written by a user request, an EXEC CICS WRITE JOURNALNAME command. The information contained in the record is set by the user within the terms of the command via the JTYPEID, PREFIX, and PFXLENG parameters. Its format is shown in Figure 96.

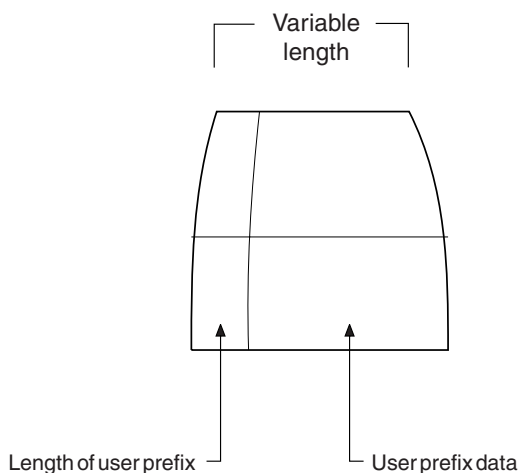

Figure 96. Format of the user prefix

Field JCSPUP is set in the system prefix area if a user prefix is present in a journal record.

The journaled data then follows. If you want a length field for the data, you must include it in the data. Alternatively, you can compute the length of the data portion of a journal record by taking the length of the system header (10 bytes), plus the length of the system prefix (JCSPLL), plus the length of the user prefix (in the field, if any, defined by yourself), and subtracting the total from the length of the journal record (JCRL):

JCRL - (system header (10) bytes + JCSP + user prefix)

Not all journal records contain journaled data.

The CICS components that issue journaling requests are journal control, file control, FEPI, and terminal control.

\*\*\*\*\*  
 \* \*                   FUNCTION IDENTIFIERS                   \* \*  
 \*\*\*\*\*

\*                   X'20' PLUS X'8-' ...USE FOR AUTOMATIC JOURNALING                   \*  
 \*                   X'40' PLUS X'8-' ...USE FOR AUTOMATIC LOGGING                   \*  
 \*\*\*\*\*

\* \*                   JOURNAL CONTROL                   \* \*  
 \*\*\*\*\*

FIDJCLAB EQU X'80'                   ...JOURNAL CONTROL LABEL                   \*  
 \*                   RECORD (DFHJCR)                   \*  
 \*\*\*\*\*

\* \*                   FILE CONTROL                   \* \*  
 \*\*\*\*\*

FIDALOG EQU X'40'                   ...AUTOMATICALLY LOGGED                   \*  
 FIDAJRN EQU X'20'                   ...AUTOMATICALLY JOURNALED                   \*  
 FIDMASS EQU X'10'                   ...MASSINSERT REQ. (FIDFCWA ONLY)                   \*  
 \*                   PLUS ONE OF...                   \*  
 FIDFCRO EQU X'80'                   ...FILE CONTROL READ-ONLY                   \*  
 FIDFCRU EQU X'81'                   ...FILE CONTROL READ-UPDATE                   \*  
 FIDFCWU EQU X'82'                   ...FILE CONTROL WRITE-UPDATE                   \*  
 FIDFCWA EQU X'83'                   ...FILE CONTROL WRITE-ADD                   \*  
 FIDFCWAC EQU X'84'                   ...FILE CONTROL WRITE-ADD-COMPLETE                   \*  
 FIDFCWD EQU X'86'                   ...FILE CONTROL WRITE DELETE                   \*  
 FIDFCBOF EQU X'88'                   ...BACKOUT FAILED LOG RECORD                   \*  
 FIDFCDSN EQU X'8F'                   ...DSNAME RECORD                   \*  
 \*                   \*  
 \*                   NOTE THAT FID\* VALUES (AS ABOVE) ARE OFTEN USED BOTH TO                   \*  
 \*                   IDENTIFY THE FUNCTION OF THE DWE AND THE FUNCTION OF THE                   \*  
 \*                   LOG RECORD. IN THE CASE OF THE FIDFC\* EQU'S ABOVE, THEY                   \*  
 \*                   ARE USED FOR LOG RECORDS ONLY. THOSE BELOW APPLY ONLY                   \*  
 \*                   TO DWE'S                   \*  
 \*                   \*  
 FIDFCVWA EQU X'80'                   THIS DWE ADDRESSES A VSWA.                   \*  
 FIDFCRVY EQU X'40'                   THIS DWE IS ASSOCIATED WITH A                   \*  
    RECOVERABLE CHANGE.                   \*

\*\*\*\*\*  
 \*                   TERMINAL CONTROL FUNCTION IDENTIFIERS                   \*  
 \*\*\*\*\*

FIDTCML EQU X'F0'                   SYNCPPOINT - LOG SEQUENCE                   \*  
 \*                   NUMBERS                   \*  
 \*                   CAN BE OR'ED WITH ANY OF                   \*  
 \*                   THE FOLLOWING THREE FIELDS:                   \*  
 FIDTCDWL EQU X'01'                   ...DEFERRED WRITE DATA                   \*  
 FIDTCFMH EQU X'02'                   ...+ FUNCTION MANAGEMENT                   \*  
 \*                   HEADER                   \*  
 FIDTCDIP EQU X'04'                   ...+ DIP REQUEST                   \*  
 \*                   \*  
 \*                   EQU X'08'                   ...DYNAMIC BACKOUT MASK                   \*  
    RESERVED                   \*  
 FIDTCAL EQU X'40'                   AUTOMATIC LOGGING MASK...                   \*  
 FIDTCAJ EQU X'20'                   AUTOMATIC JOURNALING MASK..                   \*  
 \*                   ...THE ABOVE 2 PLUS 1 OF FOLLOWING SET                   \*  
 FIDTCTL EQU X'80'                   ...SEQUENCE NUMBER ONLY                   \*  
 \*                   (LOG ONLY)                   \*  
 FIDTCIM EQU X'81'                   ...INPUT MESSAGE (LOG AND                   \*  
 \*                   JOURNAL)                   \*  
 FIDTCOM EQU X'82'                   ...OUTPUT MESSAGE (JOURNAL                   \*  
 \*                   ONLY)                   \*  
 FIDTCWP EQU X'83'                   ...WRITE WAS PURGED (LOG                   \*  
 \*                   ONLY)                   \*  
 FIDTCPRR EQU X'84'                   ...POSITIVE RESPONSE                   \*  
 \*                   RECEIVED (LOG ONLY)                   \*  
 FIDTCIMF EQU X'85'                   ...INPUT MESSAGE (W/FMH,                   \*  
 \*                   LOG AND JOURNAL)                   \*  
 FIDTCOMN EQU X'86'                   ...OUTPUT MESSAGE, (W/O                   \*  
 \*                   FMH, JOURNAL ONLY)                   \*  
 FIDTCON EQU X'87'                   ...OUTPUT MESSAGE, FMH,                   \*  
 736 Customization Guide                   CCOMPL=NO                   \*  
 FIDTCOEN EQU X'88'                   ...OUTPUT MESSAGE, W/O FMH,                   \*  
    ...CCOMPL=NO                   \*  
 FIDTCUA EQU X'89'                   ...INITIAL TCT USER AREA                   \*  
 FIDTCFIB EQU X'8A'                   ...INITIAL EXEC COMM AREA                   \*

```

*****
* *           M O D U L E   I D E N T I F I E R S           * *
*****
*
MODIDTC EQU  X'10'           ...TERMINAL CONTROL
MODIDFC EQU  X'11'           ...FILE CONTROL
MODIDJC EQU  X'45'           ...JOURNAL CONTROL
MODIDFEP EQU X'50'           ...FEPI
*
*****

```

Figure 98. Journal module identifiers

**Note:**

1. Records created by automatic journaling and automatic logging are identified by values of X'20' (FIDAJRN) and X'40' (FIDALOG) respectively, added to the “base” value of the function identifier.
2. A File Control write-delete record created by the forward recovery process (where the write-delete is done) has a function identifier of X'86' (FIDFCWD). However, if the record is created by the autojournal process it has a function identifier of X'A2', made up of X'82' (write-update or FIDFCWU) plus X'20' (FIDAJRN).

## Identifying records for the start of tasks and UOWs

You can identify records written to mark the start of tasks by examining the value of the system prefix field JCSPF1. If the JCSPSOTK bit is set, the record has been written at the start of the task.

If the JCSPPLSTK bit is set in field JCSPF1, then the record has been written at the start of the UOW.

---

## Format of journal records written to SMF

This section describes the format of journaling records that are written to an SMF data set. You need this information if you write your own program to analyze the data. The three components of the journaling record are an SMF block header, a CICS product section, and a CICS data section. The layout of an MVS SMF log, showing log blocks and CICS sections, is in Figure 99 on page 738.

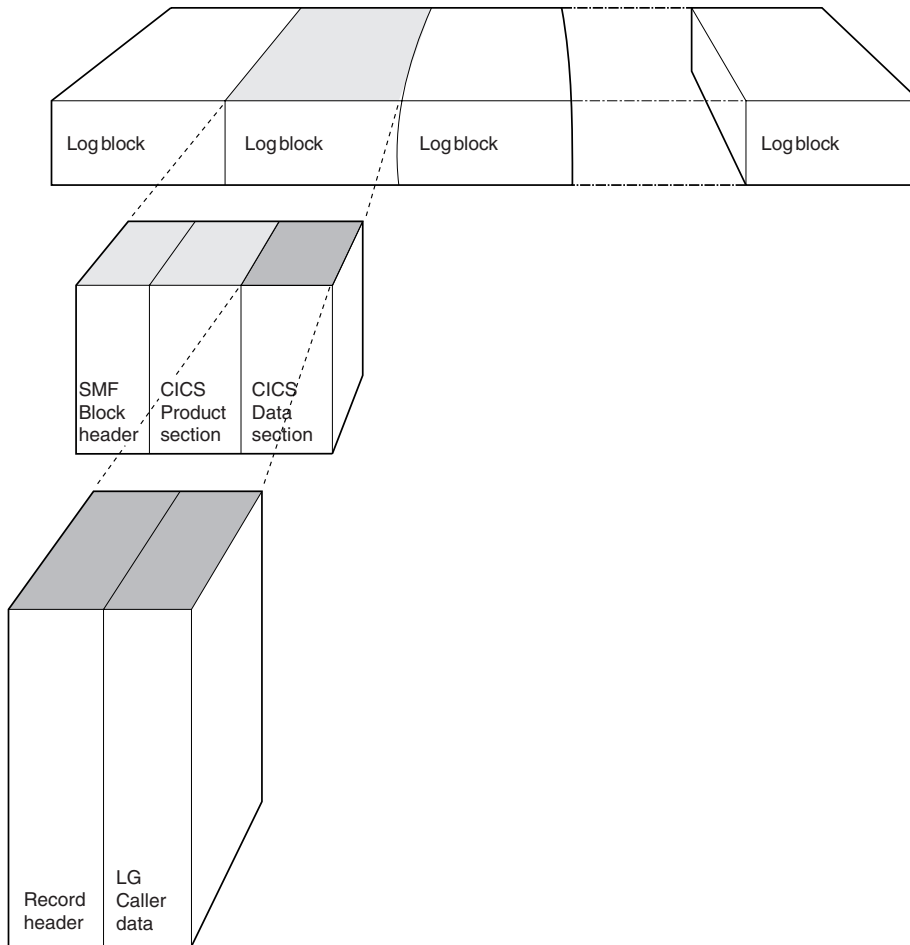

Figure 99. Layout of a CICS log written to MVS SMF

Journal records written to SMF can be read offline by user-written programs. Such programs can map journal records by including an `INCLUDE DFHLGMSD` statement. This generates the assembler version of the DSECT.

## The SMF block header

This block describes the system creating the output. Its format is shown in Figure 100 on page 739.



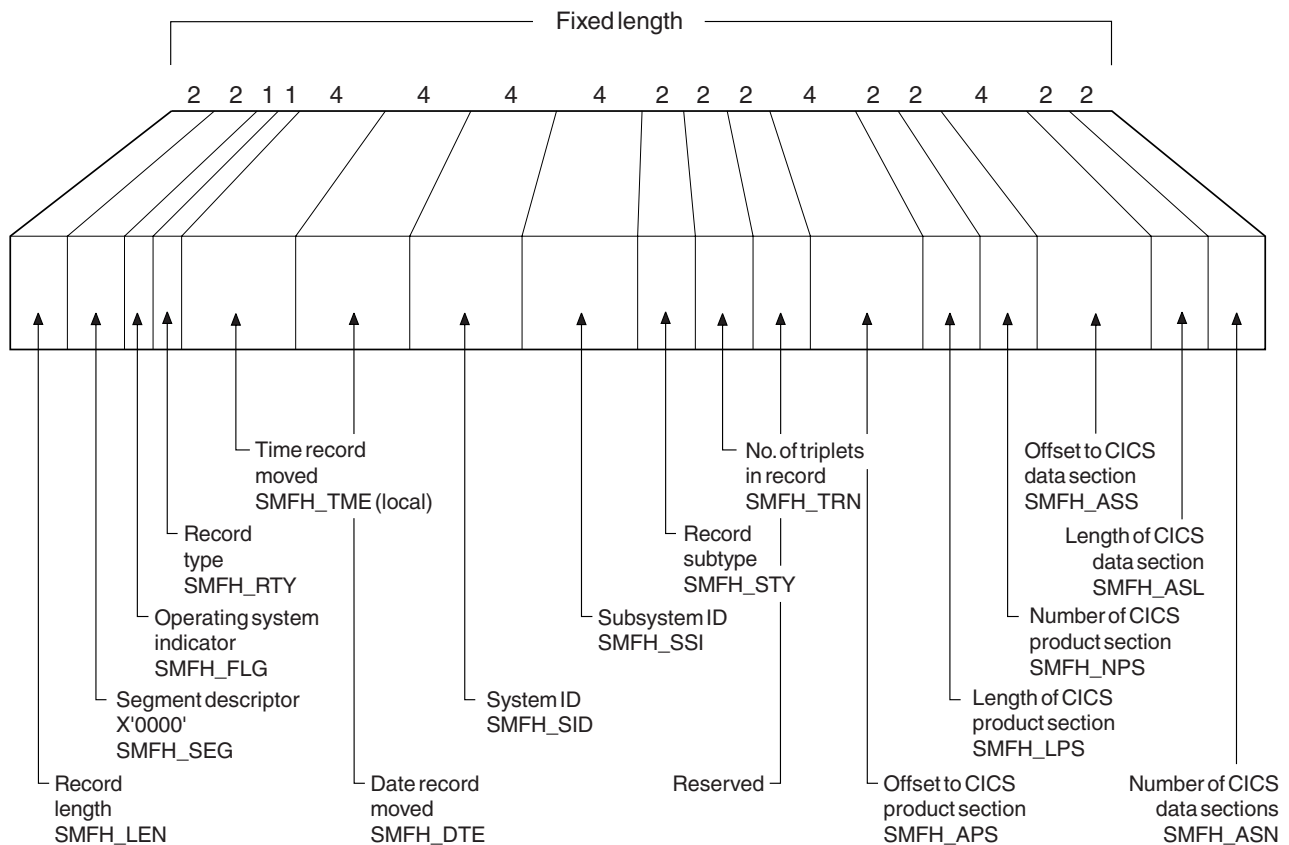

Figure 100. Format of the SMF block header

The format of the SMF block header is:

- SMFH\_LENGTH**  
2-byte record length.
- SMFH\_SEG**  
2-byte segment descriptor (X'0000').
- SMFH\_FLG**  
1-byte operating system indicator.
- SMFH\_RTY**  
1-byte record type.
- SMFH\_TME**  
4-byte (local) time record moved.
- SMFH\_DTE**  
4-byte date record moved.
- SMFH\_SID**  
4-byte system ID.
- SMFH\_SSI**  
4-byte subsystem ID.
- SMFH\_STY**  
2-byte record subtype.
- SMFH\_TRN**  
2-byte number of triplets in record.
- Reserved**  
2-byte reserved field.
- SMFH\_APS**  
4-byte offset to CICS product section.
- SMFH\_LPS**  
2-byte length of CICS product section.

**SMFH\_NPS**

2-byte number of CICS product section.

**SMFH\_ASS**

4-byte offset to CICS data section.

**SMFH\_ASL**

2-byte length of CICS data section.

**SMFH\_ASN**

2-byte number of CICS data sections.

**Note:** CICS sets only the subsystem-related bits of the operating system indicator flag byte in the SMF header (SMFH\_LG). SMF sets the remainder of the byte according to the operating system level and other factors. For an explanation of the setting of the other bits, refer to the *z/OS MVS System Management Facilities (SMF)* manual.

## The CICS product section

This section identifies the subsystem to which the journaling data relates. Its format is shown in Figure 101 on page 741.

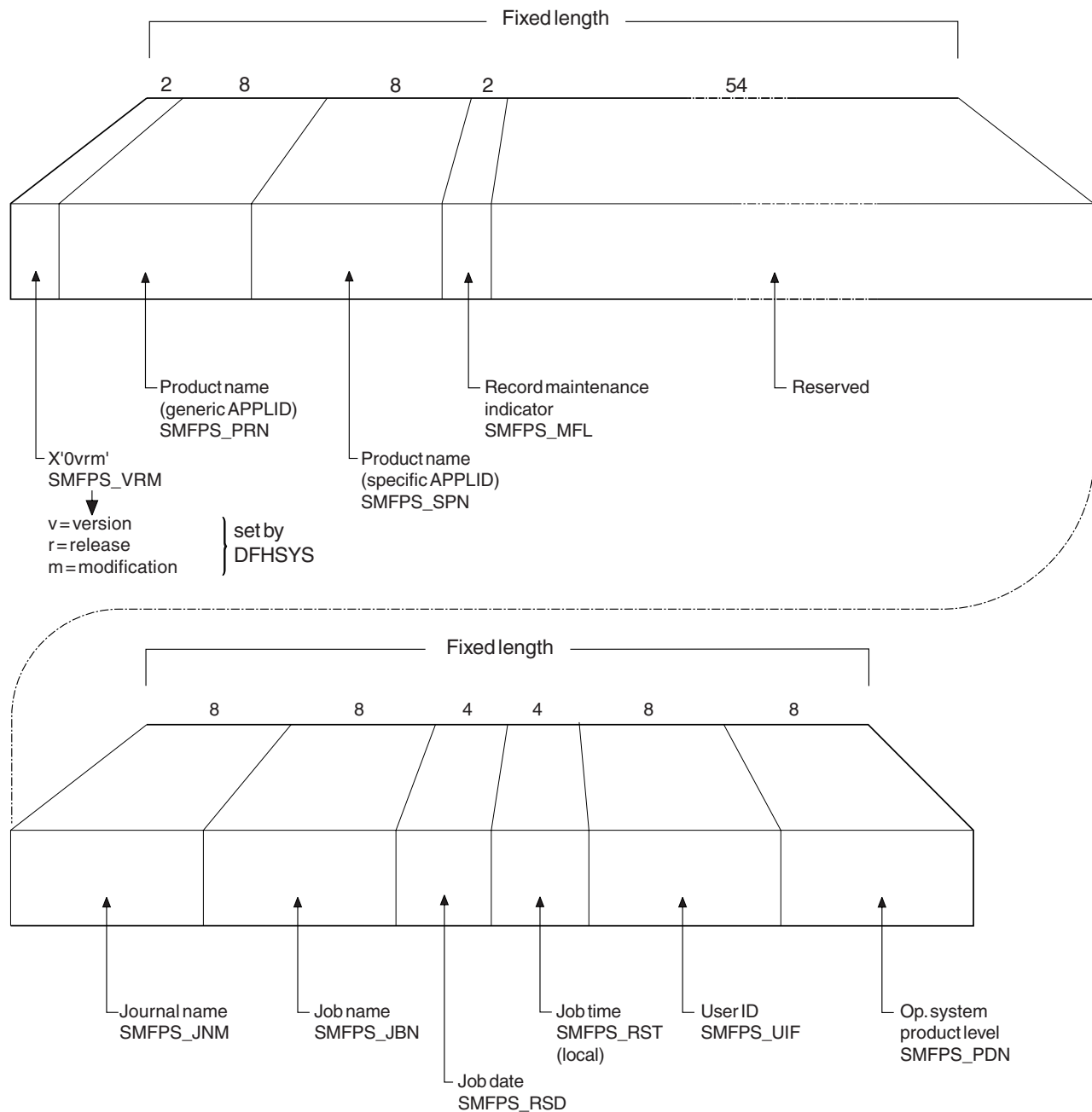

Figure 101. Format of the CICS product section

The format of the CICS product section is:

**SMFPS\_VRM**

2-byte CICS version, release, and modification information, in the format X'0vrm'.

**SMFPS\_PRN**

8-byte product name (generic APPLID).

**SMFPS\_SPN**

8-byte product name (specific APPLID).

**SMFPS\_MFL**

2-byte record maintenance indicator.

**Reserved**

54-byte reserved field.

**SMFPS\_JNM**  
8-byte journal name.

**SMFPS\_JBN**  
8-byte job name.

**SMFPS\_RSD**  
4-byte job date.

**SMFPS\_RST**  
4-byte job time (local).

**SMFPS\_UIF**  
8-byte user ID.

**SMFPS\_PDN**  
8-byte operating system product-level.

## The CICS data section

This section contains a variable number of CICS journal records. Each record comprises a general log record header, the format of which is shown in Figure 75 on page 715. This is followed by a user header, the format of which is shown in Figure 77 on page 717. This is then followed by the caller data.

If this is the first record being written to the journal after CICS initialization, the record comprises the general log record header, followed by a start-of-run record, the format of which is shown in Figure 76 on page 716. Subsequent records then take the form already described.

---

## Chapter 28. CICS monitoring

This section describes the monitoring facilities of CICS Transaction Server for z/OS, Version 3 Release 2, and tells you how to:

- Control the types of monitoring data collected by CICS.
- Gather more performance data about specific transactions than is provided automatically by CICS.

The section covers:

1. “Introduction to CICS monitoring” describes the classes of monitoring data, event-monitoring points, and the use of the monitoring control table.
2. “CICS monitoring record formats” on page 750 describes the formats of CICS monitoring SMF type 110 records.
3. Processing the output from the CICS Monitoring Facility lists the methods of processing monitoring data.

the *CICS Performance Guide*, lists all the system-defined data that can be produced by CICS monitoring.

---

### Introduction to CICS monitoring

CICS monitoring collects data about the performance of all user- and CICS-supplied transactions during online processing for later offline analysis. The records produced by CICS monitoring are of the MVS System Management Facility (SMF) type 110, and are written to an SMF data set.

Statistics records and some journaling records are also written to the SMF data set as type 110 records. You might find it particularly useful to process the statistics records and the monitoring records together, because statistics provide resource and system information that is complementary to the transaction data produced by CICS monitoring. The contents of the statistics fields, and the procedure for processing them, are described in Chapter 29, “Writing statistics collection and analysis programs,” on page 769.

Monitoring data is useful both for performance tuning and for charging your users for the resources they use.

### How CICS monitoring data is passed to SMF

The various CICS monitoring class records are written to SMF in different ways.

**Performance data records** are written to a performance record buffer, which is defined and controlled by CICS, as the records are produced. The performance records are passed to SMF for processing when the buffer is full, when the performance class of monitoring is switched off, and when CICS itself quiesces. When monitoring itself is deactivated or when there is an immediate shutdown of CICS, the performance records are not written to SMF and the data is lost.

**Transaction resource class data records** are written to a transaction resource record buffer, which is defined and controlled by CICS, as the records are produced. The transaction resource records are passed to SMF for processing when the buffer is full; when the transaction resource class of monitoring is switched off; and when CICS itself quiesces. When monitoring itself is deactivated

or when there is an immediate shutdown of CICS, the transaction resource records are not written to SMF and the data is lost.

**Exception records** are passed directly to SMF when the exception condition completes. Each exception record describes one exception condition. You can link performance records with their associated exception records by matching the value of the TRANNUM field in each type of record; each contains the same transaction number.

## Coding additional event-monitoring points

If you want to gather more performance class data than is provided at the system-defined EMPs, you can invoke user-defined EMPs in your application programs. You could use these additional EMPs to count the number of times a certain event occurs, or to time the interval between two events, for example. If the performance class was active when a transaction was started, but is not active when a user EMP is invoked, the operations defined in that user EMP are still executed on that transaction's monitoring area. However, the DELIVER option results in a loss of data at this point, because the generated performance record cannot be output while the performance class is not active. If the performance class is not active when a transaction is started, invoking the user EMP has no effect.

To invoke user EMPs in your application programs, you use the EXEC CICS MONITOR command. For programming information about this command, see MONITOR, in the *CICS Application Programming Reference* manual.

Additional EMPs are provided in some IBM program products, such as IMS DBCTL. From a CICS point of view, these are like any other user-defined EMP. EMPs in user applications and in IBM program products are identified by a decimal number. The numbers 1 through 199 are available for EMPs in user applications, and the numbers 200 through 255 are for use in IBM program products. The numbers can be qualified with an entry name, so that you can use each number more than once. For example, 'ENTRYA.4', 'ENTRYB.4', and '4' identify three different EMPs. Furthermore, any counts, clocks, or byte-strings updated at one of them are different objects from those updated at any of the others. If you do not specify an entry name, CICS assumes the default of USER.

For each EMP that you invoke in an application program, there must be a corresponding monitoring control table (MCT) definition, with the same entry name and identification number as the EMP that it describes. (The following sections refer to the combination of entry name and identification number as an **empid**.)

If you want to record the same type of data for different transactions, you can invoke the same empids in several application programs. This causes similar fields in the corresponding transaction performance records to be updated.

You do not have to assign empids to system-defined EMPs, and you do not have to code MCT entries for them.

## Application naming event monitoring points

It is not always possible to collect performance class data in the way that you would like for specific user tasks because of the way the applications are designed. It may be that you want to see performance data for individual transactions within an application, but these may not be identifiable by CICS. For example, there is a commonly-used type of design that is based on a single transaction that, when

invoked, displays a menu screen from which the user can choose a specific application. It is then possible to run all the elements of the application under the common menu transaction ID. This is very effective from the application users point of view, because they do not have to use a large number transaction IDs to run an application. However, this is not helpful from a performance monitoring point of view, because all the data is identified with a single transaction ID, and using standard CICS performance class data, it is not possible to distinguish the various elements of a large application. Having completed a long and possibly complex transaction selected from the menu, on returning to the menu the user could select an entirely different application that then runs under the same menu transaction ID. Thus, the use of menu transactions and similar design techniques can make it difficult to monitor the performance of individual parts (or tasks) of an application.

You could also have the opposite of the menu transaction, where an application runs under many different transaction IDs, and you want some means of identifying or relating all these apparently disparate items of work to the same application. Another factor to consider when trying to collect data in the way you want is the effect of invoking an EMP. Each time you invoke an EMP with an EXEC CICS MONITOR command, all the performance data collected by the system EMPs, and the data collected by the user EMPs, is cleared from the transaction's monitoring area. This makes it difficult for application designers using ordinary user-defined EMPs to control the gathering of performance class data.

To exercise greater control over the identification and collection of performance data, you can use the application naming event monitoring points that are generated for you automatically when you specify APPLNAME=YES in the DFHMCT TYPE=INITIAL macro. There are two APPLNAME EMPs generated when you assemble an MCT with APPLNAME=YES, DFHAPPL.1 and DFHAPPL.2, which perform the following default operations when invoked:

**DFHAPPL.1**

Moves 4 characters from offset 0 of the address specified on the DATA1 option of the EXEC CICS MONITOR command.

**DFHAPPL.2**

Moves 8 characters from offset 4 of the address specified on the DATA1 option of the EXEC CICS MONITOR command.

Unlike EMPs that you define explicitly with your own empids, data moved by invoking the APPLNAME EMPs is not reset by CICS, but you can set different values by invoking the APPLNAME EMPs again.

**Examples of invoking application naming EMPs**

Figure 102 on page 746 shows an assembler example of how to move a CICS transaction ID to the transaction monitoring area.

```

DFHEISTG DSECT
EMPDATA1 DS    F                               Data area for DATA1 address
*
*
* Constants for DATA2 (null value) and ENTRYNAME
*
EMPDATA2 DC    F'0'
APPLNAME DC    CL8'DFHAPPL'
*
      LA      Rn,transid Set addr of tranid
      ST      Rn,EMPDATA1 Store tranid for EMP
EXEC CICS MONITOR POINT(1) ENTRYNAME(APPLNAME)          C
      DATA1(EMPDATA1) DATA2(EMPDATA2) NOHANDLE

```

*Figure 102. EXEC CICS MONITOR commands for DFHAPPL EMPs (assembler)*

This example shows 4 bytes of user data, typically the transaction ID, being moved using the DFHAPPL.1 EMP. The data starts at offset 0, and the data length defaults to the length specified in the application naming EMP in the MCT. In this example, CICS monitoring domain uses the default length defined in the MCT, because DATA2 is defined as a null value. For the DFHAPPL EMPs, CICS monitoring domain requires you to specify both DATA1 and DATA2.

Figure 103 on page 747 shows a COBOL example of how to move a predefined application name and a transaction identifier to the transaction monitoring area. This example uses both EMP 1 and EMP 2 of the DFHAPPL EMPs, moving 4 bytes and 8 bytes respectively, which are the default lengths defined in the MCT.



```

IDENTIFICATION DIVISION.
PROGRAM-ID. APPLNAME.
ENVIRONMENT DIVISION.
DATA DIVISION.
WORKING-STORAGE SECTION.
77 APPLICATION-NAME-PTR          POINTER.
77 MENU-APPLICATION-NAME        PIC X(4)    VALUE 'MENU'.
77 PAYROLL-APPLICATION-NAME     PIC X(8)    VALUE 'PAYROLL '.
77 DFHAPPL-NAME                 PIC X(8)    VALUE 'DFHAPPL '.
77 DFHAPPL-DATA2                PIC S9(8)   COMP VALUE +0.
77 BLANKS                       PIC X      VALUE SPACE.
*
LINKAGE SECTION.
77 LS-APPLICATION-NAME          PIC X(8).
*
PROCEDURE DIVISION.
* Get storage for DFHAPPL data and set address
EXEC CICS GETMAIN FLENGTH(LENGTH OF LS-APPLICATION-NAME)
      SET (APPLICATION-NAME-PTR) INITIMG(BLANKS)
END-EXEC.
SET ADDRESS OF LS-APPLICATION-NAME TO APPLICATION-NAME-PTR.

MOVE PAYROLL-APPLICATION-NAME TO LS-APPLICATION-NAME.
* Invoke DFHAPPL EMP 2 to add the application name
EXEC CICS MONITOR ENTRYNAME(DFHAPPL-NAME) POINT(2)
      DATA1(APPLICATION-NAME-PTR) DATA2(DFHAPPL-DATA2)
      NOHANDLE
END-EXEC.
* Re-use application data area for transaction ID
MOVE MENU-APPLICATION-NAME TO LS-APPLICATION-NAME.
* Invoke DFHAPPL EMP 1 to add the transaction ID
EXEC CICS MONITOR ENTRYNAME(DFHAPPL-NAME) POINT(1)
      DATA1(APPLICATION-NAME-PTR) DATA2(DFHAPPL-DATA2)
      NOHANDLE
END-EXEC.

SET ADDRESS OF LS-APPLICATION-NAME TO NULL.

EXEC CICS FREEMAIN DATAPOINTER(APPLICATION-NAME-PTR)
      NOHANDLE
END-EXEC.

EXEC CICS RETURN END-EXEC.

```

Figure 103. EXEC CICS MONITOR commands for DFHAPPL EMPs (COBOL)

## The monitoring control table (MCT)

You can use the monitoring control table (MCT):

- To tell CICS about the EMPs that are invoked by your application programs and about the data that is to be collected at these points. The DFHMCT TYPE=EMP macro can do this.
- To tell CICS that you want specific system-defined performance data not to be recorded during a particular CICS run. The DFHMCT TYPE=RECORD macro can do this.

Full details of the DFHMCT macros are provided in the *CICS Resource Definition Guide*, and you should refer to this when reading the following sections.

## DFHMCT TYPE=EMP

There must be a DFHMCT TYPE=EMP macro definition for every user-coded EMP. The PERFORM operand of the DFHMCT TYPE=EMP macro tells CICS which user count fields, user clocks, and character values to expect at the identified user EMP, and what operations to perform on them.

The DFHMCT TYPE=EMP macro has an ID operand, whose value must be made up of the ENTRYNAME and POINT values specified on the EXEC CICS MONITOR command.

Note that, in a single run of CICS, the format of all performance records is identical, and that the length of records increases relative to the number of data fields in the user EMPs defined in the MCT.

The maximum amount of user data that can be added to performance records is 16384 bytes. The user data is divided into user areas. Each user area is defined by coding an entry name qualifier on the ID operand of the DFHMCT TYPE=EMP macro. If you code the same entry name when defining multiple EMPs, all the EMPs operate on fields in the same user area. Correspondingly, by coding different entry names you can append multiple user areas to the monitoring records. Provided that the overall maximum of 16384 bytes is not exceeded, each user area can contain:

- 0 through 256 counters
- 0 through 256 clocks
- A single 8192-byte character string.

Each user area is uniquely referenced by its entry name. For example:

```
DFHMCT TYPE=EMP, ID=ENTRYA.1, PERFORM=...
DFHMCT TYPE=EMP, ID=ENTRYA.2, PERFORM=...
DFHMCT TYPE=EMP, ID=ENTRYB.1, PERFORM=...
DFHMCT TYPE=EMP, ID=ENTRYB.2, PERFORM=...
DFHMCT TYPE=EMP, ID=1, PERFORM=...
```

In the above examples, in addition to the system-defined performance fields, three user areas, 'ENTRYA', 'ENTRYB', and 'USER', are defined (if no entry name is specified, the default is 'USER'). If the application codes an EMP invocation with ENTRYNAME(ENTRYA), only the ENTRYA user area is operated on. The only operation that spans all user areas is DELIVER, which operates across the whole monitoring area.

## DFHMCT TYPE=RECORD

The DFHMCT TYPE=RECORD macro allows you to exclude specific system-defined performance data from a CICS run.

Each field of the performance data that is gathered at the system-defined EMPs belongs to a group of fields that has a group identifier. Each performance data field also has its own numeric identifier that is unique within the group identifier. For example, the transaction sequence number field in a performance record belongs to the group DFHTASK, and has the numeric identifier '031'. Using these identifiers, you can exclude specific fields or groups of fields, and reduce the size of the performance records.

## Examples of MCT coding with MONITOR commands

These examples show some EXEC CICS MONITOR commands with the MCT entries that must be coded for them, to start a user clock, stop a user clock and update user data.

## Example 1: Starting a user clock

**Example 1** shows a user clock being started by an application that is identified as PROG3. This is the eleventh EMP in this application. To prevent confusion with the eleventh EMP in another application, this EMP is uniquely identified by the empid PROG3.11. The clock that is being started is the first clock in a string, and has the identifier CLOCKA.

Table 40. MCT coding—example 1

EXEC CICS MONITOR command	MCT entry
EXEC CICS MONITOR POINT(11) ENTRYNAME(PROG3)	DFHMCT TYPE=EMP, * CLASS=PERFORM, * ID=(PROG3.11), * CLOCK=(1,CLOCKA), * PERFORM=SCLOCK(1)

## Example 2: Stopping a user clock

**Example 2** shows the same user clock (CLOCKA) being stopped. Although this is the same clock being stopped by the same application as in example 1, it is being stopped from a different EMP. The EMP is uniquely identified by the empid PROG3.12.

Table 41. MCT coding—example 2

EXEC CICS MONITOR command	MCT entry
EXEC CICS MONITOR POINT(12) ENTRYNAME(PROG3)	DFHMCT TYPE=EMP, * CLASS=PERFORM, * ID=(PROG3.12), * PERFORM=PCLOCK(1)

## Example 3: Updating user data

**Example 3** shows 32 bytes of user data being updated in the character string reserved for that purpose. The updated data starts at offset 0, and the data is not more than 32 bytes in length.

Table 42. MCT coding—example 3

EXEC CICS MONITOR command	MCT entry
EXEC CICS MONITOR POINT(13) DATA1(address of data) DATA2(length of data) ENTRYNAME(PROG3)	DFHMCT TYPE=EMP, * CLASS=PERFORM, * ID=(PROG3.13), * PERFORM=MOVE(0,32)

## DFHMCT TYPE=EMP entries for DBCTL

These MCT entries make use of the two event-monitoring points in the performance class used by the CICS-DBCTL interface modules.

```
DFHMCT TYPE=EMP, ID=(DBCTL.1), CLASS=PERFORM, PERFORM=(MOVE(0,256)), *
      FIELD=(1,RMIDATA)
DFHMCT TYPE=EMP, ID=(DBCTL.2), CLASS=PERFORM, PERFORM=(DELIVER)
```

These MCT entries are coded in the sample copy book DFH\$MCTD.

The DBCTL data recorded by these event monitoring points can be mapped using the IMS macro DFSDSTA DSECT=YES, which is available in the IMS genlibs.

For more information about monitoring in DBCTL, see the *CICS IMS Database Control Guide*.

---

## CICS monitoring record formats

This section describes the formats of CICS monitoring SMF type 110 records in detail. You need this information if you write your own program to analyze the monitoring data.

CICS writes several types of SMF 110 record. Each type, or subtype as it is known, can be identified using the record subtype field in the SMF header. The subtype values are as follows:

- X'0000'**  
CICS journaling
- X'0001'**  
CICS monitoring
- X'0002'**  
CICS statistics
- X'0003'**  
Shared temporary storage queue server statistics
- X'0004'**  
Coupling facility data table server statistics
- X'0005'**  
Named counter sequence number server statistics

For more information about SMF journaling records, refer to Chapter 27, “CICS logging and journaling,” on page 709. For more information about SMF statistics records, refer to Chapter 29, “Writing statistics collection and analysis programs,” on page 769.

The three components of a CICS monitoring record are an SMF header, an SMF product section, and a CICS data section.

SMF Header	SMF Product Section	CICS Data Section
------------	---------------------	-------------------

Figure 104. Format of an SMF type 110 monitoring record

### SMF header and SMF product section

The SMF header describes the system creating the output. The SMF product section identifies the subsystem to which the monitoring data relates, which, in the case of CICS monitoring (and also of CICS statistics), is the CICS region.

Both the SMF header and the SMF product section can be mapped by the DSECT MNSMFDS, which you can generate using the DFHMNSMF macro as follows:

```
MNSMFDS DFHMNSMF PREFIX=SMF
```

The label 'MNSMFDS' is the default DSECT name, and SMF is the default PREFIX value, so you could also generate the DSECT simply by coding:

```
DFHMNSMF
```

The MNSMFDS DSECT has the format shown in Figure 105 on page 752.

```

*          START OF THE SMF HEADER
*
MNSMFDS  DSECT
SMFMNLEN DS   XL2          RECORD LENGTH
SMFMNSEG DS   XL2          SEGMENT DESCRIPTOR
SMFMNFLG DS   X           OPERATING SYSTEM INDICATOR (see note 1)
SMFMNRTY DC   X'6E'       RECORD 110 FOR CICS
SMFMNTME DS   XL4          TIME RECORD MOVED TO SMF
SMFMNDTE DS   XL4          DATE RECORD MOVED TO SMF
SMFMNSID DS   CL4          SYSTEM IDENTIFICATION
SMFMNSSI DS   CL4          SUBSYSTEM IDENTIFICATION
SMFMNSTY DS   XL2          RECORD SUBTYPE - MONITORING USES TYPE 1
SMFMNTRN DS   XL2          NUMBER OF TRIPLETS
          DS   XL2          RESERVED
SMFMNAPS DS   XL4          OFFSET TO PRODUCT SECTION
SMFMNLPS DS   XL2          LENGTH OF PRODUCT SECTION
SMFMNPNP DS   XL2          NUMBER OF PRODUCT SECTIONS
SMFMNASS DS   XL4          OFFSET TO DATA SECTION
SMFMNASL DS   XL2          LENGTH OF DATA SECTION
SMFMNASN DS   XL2          NUMBER OF DATA SECTIONS
*
*          THIS CONCLUDES THE SMF HEADER
*
*
*          START OF THE SMF PRODUCT SECTION
*
SMFMNRVN DS   XL2          RECORD VERSION (CICS)
SMFMNPRN DS   CL8          PRODUCT NAME (GENERIC APPLID)
SMFMNSPN DS   CL8          PRODUCT NAME (SPECIFIC APPLID)
SMFMNMFL DS   XL2          RECORD MAINTENANCE INDICATOR
          DS   XL2          RESERVED
SMFMNCL  DS   XL2          CLASS OF DATA
*
*                          1 = DICTIONARY
*                          3 = PERFORMANCE
*                          4 = EXCEPTION
*                          5 = TRANSACTION RESOURCE
SMFMNDCA DS   XL4          OFFSET TO CICS FIELD CONNECTORS
SMFMNDCL DS   XL2          LENGTH OF EACH CICS FIELD CONNECTOR
SMFMNDCN DS   XL2          NUMBER OF CICS FIELD CONNECTORS
SMFMNDRA DS   XL4          OFFSET TO FIRST CICS DATA RECORD
SMFMNDRL DS   XL2          LENGTH OF EACH CICS DATA RECORD
SMFMNDRN DS   XL2          NUMBER OF CICS DATA RECORDS
*
          DS   XL18          RESERVED
SMFMNCRL DS   XL2          COMPRESSED RECORD LENGTH (see note 7)
SMFMNTAD DS   XL4          LOCAL TOD CLOCK ADJUSTMENT VALUE
SMFMNLSO DS   XL8          LEAP SECOND OFFSET TOD FORMAT
SMFMNDTO DS   XL8          LOCAL TIME/DATE OFFSET
          DS   XL1          RESERVED
SMFMNOPN DS   XL1          MONITORING OPTIONSSMFMNJBN DS   CL8          JOBNAME
SMFMNRSD DS   XL4          JOB DATE
SMFMRSRST DS  XL4          JOB TIME
SMFMNUIF DS   CL8          USER IDENTIFICATION
SMFMNPDN DS   CL8          OPERATING SYSTEM PRODUCT LEVEL
*
*          THIS CONCLUDES THE SMF PRODUCT SECTION

```

Figure 105. Format of the SMF header and product section for monitoring records

**Note:**

1. CICS sets only the subsystem-related bits of the operating system indicator flag byte in the SMF header (SMFMNFLG). SMF sets the remainder of the byte according to the operating system level and other

factors. For an explanation of the setting of the other bits, refer to the *z/OS MVS System Management Facilities (SMF)* manual.

2. Fields SMFMNDCA SMFMNDCL, and SMFMNDCN apply to performance class records only.
3. For dictionary class monitoring records (described in “Dictionary data sections” on page 754), the fields SMFMNDRA, SMFMNDRL, and SMFMNDRN in the SMF product section have the following meaning:

**SMFMNDRA**

Offset to the first dictionary entry.

**SMFMNDRL**

Length of a single dictionary entry.

**SMFMNDRN**

Number of dictionary entries within the CICS data section.

4. For performance class and exception class monitoring records, the fields SMFMNDRA, SMFMNDRL, and SMFMNDRN, in the SMF product section have the following meaning:

**SMFMNDRA**

Offset to the first performance or exception class record.

**SMFMNDRL**

Length of each performance or exception class record.

**SMFMNDRN**

Number of performance class records in the data section, but for exception class records this value is always 1.

5. For transaction resource monitoring records, the fields SMFMNDRA, SMFMNDRL, and SMFMNDRN, in the SMF product section have the following meaning:

**SMFMNDRA**

Offset to the first transaction resource monitoring record.

**SMFMNDRL**

This value is always zero because the transaction resource records in the data section are variable length. The length of each record is in the halfword field MNR\_LENGTH at the start of each record.

**SMFMNDRN**

Number of transaction resource monitoring records in the data section.

6. The copy book DFHSMFDS is also provided and can be used to map the SMF header and the SMF product sections of all six subtypes of SMF 110 records written by CICS journaling, CICS monitoring, CICS statistics, the TS data sharing server, the coupling facility data table (CFDT) server, and the named counter sequence number server.
7. The SMFMNCRL field indicates whether the CICS data section in this monitoring SMF 110 record contains compressed data. A zero value in this field indicates that the CICS data section in the record does not contain compressed data. A non-zero value in this field indicates that the CICS data section in the record does contain compressed data, and that the z/OS Data Compression and Expansion Services must be used to expand the data section before processing. For more information on data compression, see Data compression for monitoring records.

## CICS data section

The CICS data section can be made up of a dictionary data section, a performance data section, an exception data section, or a transaction resource data section. You can identify which of these you are dealing with by looking at the value of field SMFMNCL in the SMF product section.

If data compression has been used, the z/OS Data Compression and Expansion Services must be used to expand the data section before processing. For more information on data compression, see *Data compression for monitoring records*.

Each of the data section types is described in the following topics:

- “Dictionary data sections”
- “Performance data sections” on page 761
- “Relationship of the dictionary record to the performance records: field connectors” on page 762
- “Exception data sections” on page 764
- “Transaction resource data sections” on page 765

### Dictionary data sections

Dictionary data sections describe all the fields in the performance data records that are gathered during this CICS run.

Dictionary data sections describe **all** the system-provided data fields (whether you have excluded any or not), plus any user-provided data fields, which CICS takes at initialization time from the MCT entries you have coded. This means that the descriptions of the system-provided data fields never change, though the user data fields can be changed each time CICS is initialized. The contents of the dictionary data sections cannot be changed while CICS is running.

Dictionary data sections contain a variable number of 26-byte dictionary entries. Each dictionary entry provides the following information about a single performance record data field:

#### **CMODNAME**

The identifier of the group to which the field belongs.

#### **CMODTYPE**

The field type.

#### **CMODIDNT**

The field identifier.

#### **CMODLENG**

The length of the field.

#### **CMODCONN**

The connector value assigned to the field.

#### **CMODOFST**

The offset of the field.

#### **CMODHEAD**

The informal name of the field.

You can map the dictionary entries by generating a DSECT with the DFHMCTDR macro, as shown in Figure 106 on page 755.



DFHMCTDR TYPE=(PREFIX,CMO)

CMO is the default label prefix. The DSECT is as follows:

```

CMODNAME DS   CL8   + 0   NAME OF OWNER (entry name)
CMODTYPE DS   C     + 8   OBJECT TYPE
*
*             'S' = STOPWATCH (CLOCK)
*             'A' = ACCUMULATOR (COUNT)
*             'C' = BYTE-STRING FIELD
*             'T' = TIMESTAMP (STCK FORMAT)
*             'P' = PACKED-DECIMAL FIELD
CMODIDNT DS   CL3   +9   ID WITHIN TYPE
*             CLOCK-, COUNT-, OR FIELD-NO.
CMODLENG DS   H     +12  LENGTH OF OBJECT
CMODCONN DS   XL2   +14  ASSIGNED CONNECTOR
CMODOFST DS   XL2   +16  ASSIGNED OFFSET
CMODHEAD DS   CL8   +18  INFORMAL NAME
CMODNEXT EQU   *

```

Figure 106. CICS monitoring dictionary entry DSECT

Whenever the monitoring of performance class data is switched on, whether at CICS initialization or while CICS is running, a dictionary data section is written. So, if the monitoring of performance class data is switched on and off three times during a single CICS run, there are three separate, but identical, dictionary data sections for that run. The dictionary data section is passed to SMF, together with any performance data sections, when the first buffer of performance data sections for a performance class data monitoring session is output to SMF. Any offline utility should use the most recent dictionary record encountered when processing CICS monitoring records.

The format of dictionary data sections is shown in Figure 107.

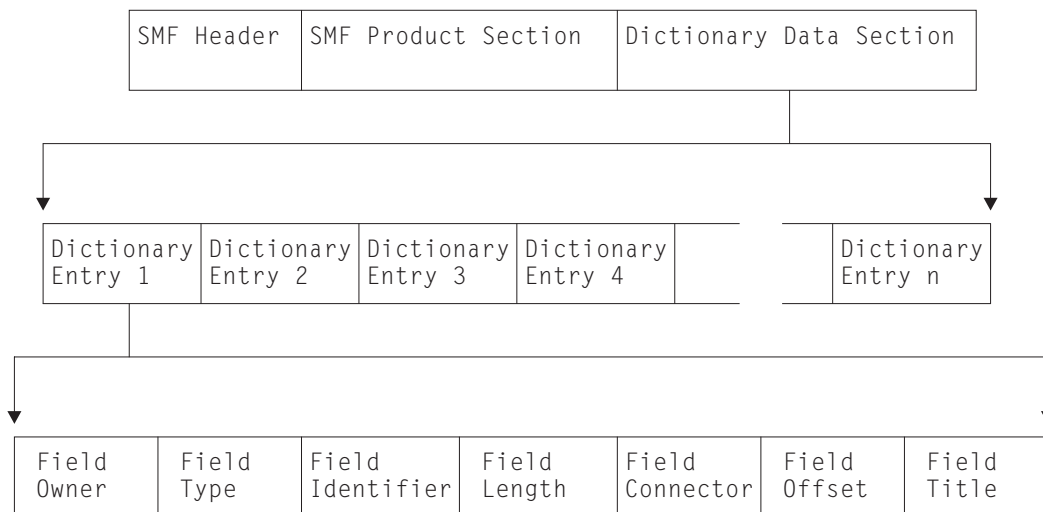

Figure 107. Format of the CICS monitoring dictionary data section

**Default CICS dictionary entries:**

These are the default CICS dictionary entries in the dictionary data sections of CICS monitoring SMF type 110 records.

The “field types” in Figure 108 on page 757 are:

- A** Count

- C** Byte-string
- P** Packed decimal number
- S** Clock
- T** Time stamp

FIELD-NAME	SIZE	CONNECTOR	OFFSET	NICKNAME	
DFHTASK	C001	4	X'0001'	X'0000'	TRAN
DFHTERM	C002	4	X'0002'	X'0004'	TERM
DFHCICS	C089	8	X'0003'	X'0008'	USERID
DFHTASK	C004	4	X'0004'	X'0010'	TTYPE
DFHCICS	T005	8	X'0005'	X'0014'	START
DFHCICS	T006	8	X'0006'	X'001C'	STOP
DFHTASK	P031	4	X'0007'	X'0024'	TRANNUM
DFHTASK	A109	4	X'0008'	X'0028'	TRANPRI
DFHTASK	C166	8	X'0009'	X'002C'	TCLSNAME
DFHTERM	C111	8	X'000A'	X'0034'	LUNAME
DFHPROG	C071	8	X'000B'	X'003C'	PGMNAME
DFHTASK	C097	20	X'000C'	X'0044'	NETUOWPX
DFHTASK	C098	8	X'000D'	X'0058'	NETUOWSX
DFHCICS	C130	4	X'000E'	X'0060'	RSYSID
DFHCICS	A131	4	X'000F'	X'0064'	PERRECNT
DFHTASK	T132	8	X'0010'	X'0068'	RMUOWID
DFHCICS	C167	8	X'0011'	X'0070'	SRVCLSNM
DFHCICS	C168	8	X'0012'	X'0078'	RPTCLSNM
DFHTASK	C163	4	X'0013'	X'0080'	FCTYNAME
DFHTASK	A164	8	X'0014'	X'0084'	TRANFLAG
DFHTERM	A165	4	X'0015'	X'008C'	TERMINFO
DFHTERM	C169	4	X'0016'	X'0090'	TERMCNNM
DFHTASK	C124	4	X'0017'	X'0094'	BRDGTRAN
DFHTASK	C190	16	X'0018'	X'0098'	RRMSURID
DFHCBTS	C200	36	X'0019'	X'00A8'	PRCSNAME
DFHCBTS	C201	8	X'001A'	X'00CC'	PRCSTYPE
DFHCBTS	C202	52	X'001B'	X'00D4'	PRCSID
DFHCBTS	C203	52	X'001C'	X'0108'	ACTVTYID
DFHCBTS	C204	16	X'001D'	X'013C'	ACTVTYNM
DFH SOCK	C244	16	X'001E'	X'014C'	CLIPADDR
DFHTASK	C082	28	X'001F'	X'015C'	TRNGRPID
DFHTERM	C197	8	X'0020'	X'0178'	NETID
DFHTERM	C198	8	X'0021'	X'0180'	RLUNAME
DFH SOCK	C245	8	X'0022'	X'0188'	TCPSRVCE
DFH SOCK	A246	4	X'0023'	X'0190'	PORTNUM
DFHTASK	C194	128	X'0024'	X'0194'	OTSTID
DFHEJBS	C311	4	X'0025'	X'0214'	CBSVRNM
DFH SOCK	A330	4	X'0026'	X'0218'	CLIPPORT
DFH SOCK	C305	8	X'0027'	X'021C'	ISIPCNNM
DFHCICS	C359	8	X'0028'	X'0224'	ONETWKID
DFHCICS	C360	8	X'0029'	X'022C'	OAPPLID
DFHCICS	T361	8	X'002A'	X'0234'	OSTART
DFHCICS	P362	4	X'002B'	X'023C'	OTRANNUM
DFHCICS	C363	4	X'002C'	X'0240'	OTRAN
DFHCICS	C364	8	X'002D'	X'0244'	OUSERID
DFHCICS	C365	64	X'002E'	X'024C'	OUSERCOR
DFHCICS	C366	8	X'002F'	X'028C'	OTCPSVCE
DFHCICS	A367	4	X'0030'	X'0294'	OPORTNUM
DFHCICS	C368	16	X'0031'	X'0298'	OCLIPADR
DFHCICS	A369	4	X'0032'	X'02A8'	OCLIPORT
DFHCICS	A370	8	X'0033'	X'02AC'	OTRANFLG
DFHCICS	C371	8	X'0034'	X'02B4'	OFCTYNME
DFHTASK	C064	4	X'0035'	X'02BC'	TASKFLAG
DFHPROG	C113	4	X'0036'	X'02C0'	ABCODE0
DFHPROG	C114	4	X'0037'	X'02C4'	ABCODEC
DFHCICS	C112	4	X'0038'	X'02C8'	RTYPE
DFHTERM	A034	4	X'0039'	X'02CC'	TCMSGIN1
DFHTERM	A083	4	X'003A'	X'02D0'	TCCHRIN1
DFHTERM	A035	4	X'003B'	X'02D4'	TCMSGOU1
DFHTERM	A084	4	X'003C'	X'02D8'	TCCHROU1
DFHTERM	A067	4	X'003D'	X'02DC'	TCMSGIN2
DFHTERM	A085	4	X'003E'	X'02E0'	TCCHRIN2
DFHTERM	A068	4	X'003F'	X'02E4'	TCMSGOU2
DFHTERM	A086	4	X'0040'	X'02E8'	TCCHROU2
DFHTERM	A135	4	X'0041'	X'02EC'	TCM62IN2
DFHTERM	A137	4	X'0042'	X'02F0'	TCC62IN2
DFHTERM	A136	4	X'0043'	X'02F4'	TCM62OU2
DFHTERM	A138	4	X'0044'	X'02F8'	TCC62OU2
DFHTERM	A069	4	X'0045'	X'02FC'	TCALLOCT
DFHSTOR	A054	4	X'0046'	X'0300'	SCUGETCT
DFHSTOR	A105	4	X'0047'	X'0304'	SCUGETCT
DFHSTOR	A117	4	X'0048'	X'0308'	SCCGETCT

FIELD-NAME	SIZE	CONNECTOR	OFFSET	NICKNAME	
DFHSTOR	A106	4	X'004B'	X'0314'	SCUSRHWM
DFHSTOR	A116	4	X'004C'	X'0318'	SC24CHWM
DFHSTOR	A119	4	X'004D'	X'031C'	SC31CHWM
DFHSTOR	A095	8	X'004E'	X'0320'	SCUSRSTG
DFHSTOR	A107	8	X'004F'	X'0328'	SCUSRSTG
DFHSTOR	A118	8	X'0050'	X'0330'	SC24COCC
DFHSTOR	A121	8	X'0051'	X'0338'	SC31COCC
DFHSTOR	A144	4	X'0052'	X'0340'	SC24SGCT
DFHSTOR	A145	4	X'0053'	X'0344'	SC24GSHR
DFHSTOR	A146	4	X'0054'	X'0348'	SC24FSHR
DFHSTOR	A147	4	X'0055'	X'034C'	SC31SGCT
DFHSTOR	A148	4	X'0056'	X'0350'	SC31GSHR
DFHSTOR	A149	4	X'0057'	X'0354'	SC31FSHR
DFHSTOR	A087	4	X'0058'	X'0358'	PCSTGHWM
DFHSTOR	A139	4	X'0059'	X'035C'	PC31AHWM
DFHSTOR	A108	4	X'005A'	X'0360'	PC24BHWM
DFHSTOR	A142	4	X'005B'	X'0364'	PC31CHWM
DFHSTOR	A143	4	X'005C'	X'0368'	PC24CHWM
DFHSTOR	A122	4	X'005D'	X'036C'	PC31RHWM
DFHSTOR	A162	4	X'005E'	X'0370'	PC24RHWM
DFHSTOR	A161	4	X'005F'	X'0374'	PC31SHWM
DFHSTOR	A160	4	X'0060'	X'0378'	PC24SHWM
DFHFILE	A036	4	X'0061'	X'037C'	FCGETCT
DFHFILE	A037	4	X'0062'	X'0380'	FCPUTCT
DFHFILE	A038	4	X'0063'	X'0384'	FCBRWCT
DFHFILE	A039	4	X'0064'	X'0388'	FCADDCT
DFHFILE	A040	4	X'0065'	X'038C'	FCDELCT
DFHFILE	A093	4	X'0066'	X'0390'	FCTOTCT
DFHFILE	A070	4	X'0067'	X'0394'	FCAMCT
DFHDEST	A041	4	X'0068'	X'0398'	TDGETCT
DFHDEST	A042	4	X'0069'	X'039C'	TDPUTCT
DFHDEST	A043	4	X'006A'	X'03A0'	TDPURCT
DFHDEST	A091	4	X'006B'	X'03A4'	TDTOTCT
DFHTEMP	A044	4	X'006C'	X'03A8'	TSGETCT
DFHTEMP	A046	4	X'006D'	X'03AC'	TSPUTACT
DFHTEMP	A047	4	X'006E'	X'03B0'	TSPUTMCT
DFHTEMP	A092	4	X'006F'	X'03B4'	TSTOTCT
DFHMAPP	A050	4	X'0070'	X'03B8'	BMSMAPCT
DFHMAPP	A051	4	X'0071'	X'03BC'	BMSINCT
DFHMAPP	A052	4	X'0072'	X'03C0'	BMSOUTCT
DFHMAPP	A090	4	X'0073'	X'03C4'	BMSTOTCT
DFHPROG	A055	4	X'0074'	X'03C8'	PCLINKCT
DFHPROG	A056	4	X'0075'	X'03CC'	PCXCTLCT
DFHPROG	A057	4	X'0076'	X'03D0'	PCLOADCT
DFHPROG	A072	4	X'0077'	X'03D4'	PCLURMCT
DFHPROG	A073	4	X'0078'	X'03D8'	PCDPLCT
DFHPROG	A286	4	X'0079'	X'03DC'	PCDLCSDL
DFHPROG	A287	4	X'007A'	X'03E0'	PCDLCRDL
DFHPROG	A306	4	X'007B'	X'03E4'	PCLNKCCT
DFHPROG	A307	4	X'007C'	X'03E8'	PCXCCLCT
DFHPROG	A308	4	X'007D'	X'03EC'	PCDPLCCT
DFHPROG	A309	4	X'007E'	X'03F0'	PCRTNCCT
DFHPROG	A310	4	X'007F'	X'03F4'	PCRTNCDL
DFHJOUR	A058	4	X'0080'	X'03F8'	JNLWRTCT
DFHJOUR	A172	4	X'0081'	X'03FC'	LOGWRTCT
DFHTASK	A059	4	X'0082'	X'0400'	ICPUINCT
DFHTASK	A066	4	X'0083'	X'0404'	ICTOTCT
DFHTASK	A065	4	X'0084'	X'0408'	ICSTACCT
DFHTASK	A345	4	X'0085'	X'040C'	ICSTACDL

Figure 109. Default CICS dictionary entries (part 2)

FIELD-NAME	SIZE	CONNECTOR	OFFSET	NICKNAME	
DFHTASK	A346	4	X'0086'	X'0410'	ICSTRCCT
DFHTASK	A347	4	X'0087'	X'0414'	ICSTRCDL
DFHSYNC	A060	4	X'0088'	X'0418'	SPSYNCCT
DFHCICS	A025	4	X'0089'	X'041C'	CFCAPICT
DFHFPEI	A150	4	X'008A'	X'0420'	SZALLOCT
DFHFPEI	A151	4	X'008B'	X'0424'	SZRCVCT
DFHFPEI	A152	4	X'008C'	X'0428'	SZSENDCT
DFHFPEI	A153	4	X'008D'	X'042C'	SZSTRTCT
DFHFPEI	A154	4	X'008E'	X'0430'	SZCHROUT
DFHFPEI	A155	4	X'008F'	X'0434'	SZCHRIN
DFHFPEI	A157	4	X'0090'	X'0438'	SZALLCTO
DFHFPEI	A158	4	X'0091'	X'043C'	SZRCVTO
DFHFPEI	A159	4	X'0092'	X'0440'	SZTOTCT
DFHCBTS	A205	4	X'0093'	X'0444'	BARSYNCT
DFHCBTS	A206	4	X'0094'	X'0448'	BARASYCT
DFHCBTS	A207	4	X'0095'	X'044C'	BALKPACT
DFHCBTS	A208	4	X'0096'	X'0450'	BADPROCT
DFHCBTS	A209	4	X'0097'	X'0454'	BADACTCT
DFHCBTS	A210	4	X'0098'	X'0458'	BARSPACT
DFHCBTS	A211	4	X'0099'	X'045C'	BASUPACT
DFHCBTS	A212	4	X'009A'	X'0460'	BARMPACT
DFHCBTS	A213	4	X'009B'	X'0464'	BADCPACT
DFHCBTS	A214	4	X'009C'	X'0468'	BAACQPCT
DFHCBTS	A215	4	X'009D'	X'046C'	BATOTPCT
DFHCBTS	A216	4	X'009E'	X'0470'	BAPRDCCT
DFHCBTS	A217	4	X'009F'	X'0474'	BAACDCCT
DFHCBTS	A218	4	X'00A0'	X'0478'	BATOCCT
DFHCBTS	A219	4	X'00A1'	X'047C'	BARATECT
DFHCBTS	A220	4	X'00A2'	X'0480'	BADFIECT
DFHCBTS	A221	4	X'00A3'	X'0484'	BATIAECT
DFHCBTS	A222	4	X'00A4'	X'0488'	BATOTECT
DFHWEBB	A231	4	X'00A5'	X'048C'	WBRCVCT
DFHWEBB	A232	4	X'00A6'	X'0490'	WBCHRIN
DFHWEBB	A233	4	X'00A7'	X'0494'	WSENDCT
DFHWEBB	A234	4	X'00A8'	X'0498'	WBCHROUT
DFHWEBB	A235	4	X'00A9'	X'049C'	WBTOTCT
DFHWEBB	A236	4	X'00AA'	X'04A0'	WBREPACT
DFHWEBB	A237	4	X'00AB'	X'04A4'	WBREPACT
DFHWEBB	A238	4	X'00AC'	X'04A8'	WBEXTRCT
DFHWEBB	A239	4	X'00AD'	X'04AC'	WBBRWCT
DFHWEBB	A224	4	X'00AE'	X'04B0'	WBREADCT
DFHWEBB	A225	4	X'00AF'	X'04B4'	WBWRITCT
DFHDOCH	A226	4	X'00B0'	X'04B8'	DHCRECT
DFHDOCH	A227	4	X'00B1'	X'04BC'	DHINSCT
DFHDOCH	A228	4	X'00B2'	X'04C0'	DHSETCT
DFHDOCH	A229	4	X'00B3'	X'04C4'	DHRETCT
DFHDOCH	A223	4	X'00B4'	X'04C8'	DHDELCT
DFHDOCH	A230	4	X'00B5'	X'04CC'	DHTOTCT
DFHDOCH	A240	4	X'00B6'	X'04D0'	DHTOTDCL
DFHSOCK	A242	4	X'00B7'	X'04D4'	SOBYENCT
DFHSOCK	A243	4	X'00B8'	X'04D8'	SOBYDECT
DFHSOCK	A289	4	X'00B9'	X'04DC'	SOEXTRCT
DFHSOCK	A290	4	X'00BA'	X'04E0'	SOCNPSCT
DFHSOCK	A291	4	X'00BB'	X'04E4'	SOCPSCT
DFHSOCK	A292	4	X'00BC'	X'04E8'	SONPSHWM
DFHSOCK	A293	4	X'00BD'	X'04EC'	SOPSHWM
DFHSOCK	A294	4	X'00BE'	X'04F0'	SORCVCT
DFHSOCK	A295	4	X'00BF'	X'04F4'	SOCHRIN
DFHSOCK	A296	4	X'00C0'	X'04F8'	SOSENDCT
DFHSOCK	A297	4	X'00C1'	X'04FC'	SOCHROUT

Figure 110. Default CICS dictionary entries (part 3)

FIELD-NAME	SIZE	CONNECTOR	OFFSET	NICKNAME	
DFH SOCK	A298	4	X'00C2'	X'0500'	SOTOTCT
DFH SOCK	A301	4	X'00C3'	X'0504'	SOMSGIN1
DFH SOCK	A302	4	X'00C4'	X'0508'	SOCHRIN1
DFH SOCK	A303	4	X'00C5'	X'050C'	SOMSGOU1
DFH SOCK	A304	4	X'00C6'	X'0510'	SOCHROU1
DFH DATA	A179	4	X'00C7'	X'0514'	IMSREQCT
DFH DATA	A180	4	X'00C8'	X'0518'	DB2REQCT
DFH DATA	A395	4	X'00C9'	X'051C'	WMQREQCT
DFH TASK	A251	4	X'00CA'	X'0520'	TCBATTCT
DFH TASK	A252	4	X'00CB'	X'0524'	DSTCBHWM
DFHEJBS	A312	4	X'00CC'	X'0528'	EJBSACCT
DFHEJBS	A313	4	X'00CD'	X'052C'	EJBSPACT
DFHEJBS	A314	4	X'00CE'	X'0530'	EJBCRECT
DFHEJBS	A315	4	X'00CF'	X'0534'	EJBREMCT
DFHEJBS	A316	4	X'00D0'	X'0538'	EJBMTHCT
DFHEJBS	A317	4	X'00D1'	X'053C'	EJBTOTCT
DFH WEBB	A331	4	X'00D2'	X'0540'	WBREDOCT
DFH WEBB	A332	4	X'00D3'	X'0544'	WBWRTOCT
DFH WEBB	A333	4	X'00D4'	X'0548'	WBRCVIN1
DFH WEBB	A334	4	X'00D5'	X'054C'	WBCHRIN1
DFH WEBB	A335	4	X'00D6'	X'0550'	WBSNDOU1
DFH WEBB	A336	4	X'00D7'	X'0554'	WBCHROU1
DFH WEBB	A337	4	X'00D8'	X'0558'	WBPARSCT
DFH WEBB	A338	4	X'00D9'	X'055C'	WBBRWOC
DFH WEBB	A340	4	X'00DA'	X'0560'	WBIWBSCT
DFH WEBB	A341	4	X'00DB'	X'0564'	WBREPRDL
DFH WEBB	A342	4	X'00DC'	X'0568'	WBREPWDL
DFH CHNL	A321	4	X'00DD'	X'056C'	PGTOTCCT
DFH CHNL	A322	4	X'00DE'	X'0570'	PGBRWCCCT
DFH CHNL	A323	4	X'00DF'	X'0574'	PGGETCCT
DFH CHNL	A324	4	X'00E0'	X'0578'	PGPUTCCT
DFH CHNL	A325	4	X'00E1'	X'057C'	PGMOVCCCT
DFH CHNL	A326	4	X'00E2'	X'0580'	PGGETCDL
DFH CHNL	A327	4	X'00E3'	X'0584'	PGPUTCDL
DFH CHNL	A328	4	X'00E4'	X'0588'	PGCRECCT
DFH CHNL	A329	4	X'00E5'	X'058C'	PGCSTHWM
DFH SOCK	A288	4	X'00E6'	X'0590'	ISALLOCT
DFH TASK	S007	12	X'00E7'	X'0594'	USRDISPT
DFH TASK	S008	12	X'00E8'	X'05A0'	USRCPUT
DFH TASK	S014	12	X'00E9'	X'05AC'	SUSPTIME
DFH TASK	S102	12	X'00EA'	X'05B8'	DISPWTT
DFH TASK	S255	12	X'00EB'	X'05C4'	QRDISPT
DFH TASK	S256	12	X'00EC'	X'05D0'	QRCPUT
DFH TASK	S257	12	X'00ED'	X'05DC'	MSDISPT
DFH TASK	S258	12	X'00EE'	X'05E8'	MSCPUT
DFH TASK	S269	12	X'00EF'	X'05F4'	RODISPT
DFH TASK	S270	12	X'00F0'	X'0600'	ROCPUT
DFH TASK	S262	12	X'00F1'	X'060C'	KY8DISPT
DFH TASK	S263	12	X'00F2'	X'0618'	KY8CPUT
DFH TASK	S264	12	X'00F3'	X'0624'	KY9DISPT
DFH TASK	S265	12	X'00F4'	X'0630'	KY9CPUT
DFH TASK	S259	12	X'00F5'	X'063C'	L8CPUT
DFH TASK	S266	12	X'00F6'	X'0648'	L9CPUT
DFH TASK	S260	12	X'00F7'	X'0654'	J8CPUT
DFH TASK	S261	12	X'00F8'	X'0660'	S8CPUT
DFH TASK	S267	12	X'00F9'	X'066C'	J9CPUT
DFH TASK	S271	12	X'00FA'	X'0678'	X8CPUT
DFH TASK	S272	12	X'00FB'	X'0684'	X9CPUT
DFH TASK	S249	12	X'00FC'	X'0690'	QRMODDLY
DFH TASK	S250	12	X'00FD'	X'069C'	MAXOTDLY
DFH TASK	S277	12	X'00FE'	X'06A8'	MAXJTDLY
DFH TASK	S282	12	X'00FF'	X'06B4'	MAXXTDLY

Figure 111. Default CICS dictionary entries (part 4)

FIELD-NAME	SIZE	CONNECTOR	OFFSET	NICKNAME	
DFHTASK	S281	12	X'0100'	X'06C0'	MAXSTDLY
DFHTASK	S268	12	X'0101'	X'06CC'	DSTCBMWT
DFHTASK	S247	12	X'0102'	X'06D8'	DSCHMDLY
DFHCICS	S103	12	X'0103'	X'06E4'	EXWTTIME
DFHTERM	S009	12	X'0104'	X'06F0'	TCIOWTT
DFHFILE	S063	12	X'0105'	X'06FC'	FCIOWTT
DFHJOUR	S010	12	X'0106'	X'0708'	JCIOWTT
DFHTEMP	S011	12	X'0107'	X'0714'	TSIOWTT
DFHTERM	S100	12	X'0108'	X'0720'	IRIOWTT
DFHDEST	S101	12	X'0109'	X'072C'	TDIOWTT
DFHPROG	S115	12	X'010A'	X'0738'	PCLOADTM
DFHTASK	S125	12	X'010B'	X'0744'	DSPDELAY
DFHTASK	S126	12	X'010C'	X'0750'	TCLDELAY
DFHTASK	S127	12	X'010D'	X'075C'	MXTDELAY
DFHTASK	S129	12	X'010E'	X'0768'	ENQDELAY
DFHTASK	S123	12	X'010F'	X'0774'	GNQDELAY
DFHTERM	S133	12	X'0110'	X'0780'	LU61WTT
DFHTERM	S134	12	X'0111'	X'078C'	LU62WTT
DFHFEP1	S156	12	X'0112'	X'0798'	SZWAIT
DFHTASK	S170	12	X'0113'	X'07A4'	RMITIME
DFHTASK	S171	12	X'0114'	X'07B0'	RMISUSP
DFHSYNC	S173	12	X'0115'	X'07BC'	SYNCTIME
DFHFILE	S174	12	X'0116'	X'07C8'	RLSWAIT
DFHFILE	S175	12	X'0117'	X'07D4'	RLSCPUT
DFHTASK	S128	12	X'0118'	X'07E0'	LMDELAY
DFHTASK	S181	12	X'0119'	X'07EC'	WTEXWAIT
DFHTASK	S182	12	X'011A'	X'07F8'	WTCEWAIT
DFHTASK	S183	12	X'011B'	X'0804'	ICDELAY
DFHTASK	S184	12	X'011C'	X'0810'	GVUPWAIT
DFHTEMP	S178	12	X'011D'	X'081C'	TSSHWAIT
DFHFILE	S176	12	X'011E'	X'0828'	CFDTPWAIT
DFHSYNC	S177	12	X'011F'	X'0834'	SRVSYWTT
DFHTASK	S191	12	X'0120'	X'0840'	RRMSWAIT
DFHTASK	S195	12	X'0121'	X'084C'	RUNTRWTT
DFHSYNC	S196	12	X'0122'	X'0858'	SYNCDLY
DFH SOCK	S241	12	X'0123'	X'0864'	SOIOWTT
DFHDATA	S186	12	X'0124'	X'0870'	IMSWAIT
DFHDATA	S187	12	X'0125'	X'087C'	DB2RDYQW
DFHDATA	S188	12	X'0126'	X'0888'	DB2CONWT
DFHDATA	S189	12	X'0127'	X'0894'	DB2WAIT
DFHDATA	S396	12	X'0128'	X'08A0'	WMQGETWT
DFHTASK	S253	12	X'0129'	X'08AC'	JVMTIME
DFHTASK	S254	12	X'012A'	X'08B8'	JVMSUSP
DFH SOCK	S299	12	X'012B'	X'08C4'	SOOIOWTT
DFHTASK	S192	12	X'012C'	X'08D0'	RQRWAIT
DFHTASK	S193	12	X'012D'	X'08DC'	RQPWAIT
DFHSYNC	S199	12	X'012E'	X'08E8'	OTSINDWT
DFHTASK	S273	12	X'012F'	X'08F4'	JVMITIME
DFHTASK	S275	12	X'0130'	X'0900'	JVMRTIME
DFHTASK	S285	12	X'0131'	X'090C'	PTPWAIT
DFHTASK	S279	12	X'0132'	X'0918'	DSMMSWT
DFH SOCK	S300	12	X'0133'	X'0924'	ISIOWTT

Figure 112. Default CICS dictionary entries (part 5)

## Performance data sections

Each performance data section is made up of a string of field connectors, followed by one or more performance data records.

All of the performance records produced by a single CICS run have the same format. The default length of the performance records is given in the topic Performance class data in the *CICS Performance Guide*. The length of the

performance records changes if you add user data at user event monitoring points (EMPs), or if you exclude any system-defined data from the monitoring process.

All of the system-defined data fields in the performance records are described in Performance class data: listing of data fields , in the *CICS Performance Guide*.

The format of the performance data section is shown in Figure 113.

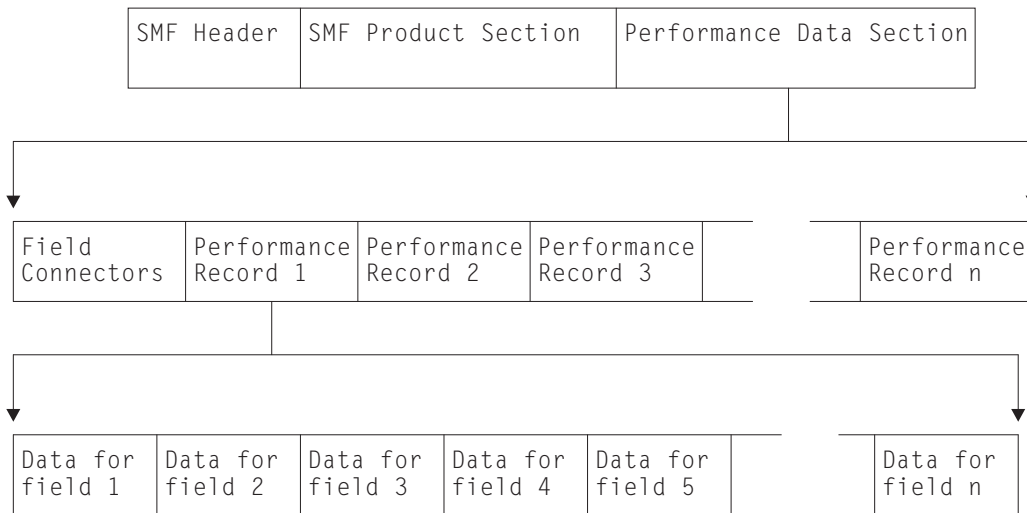

Figure 113. Format of the performance data section

### Relationship of the dictionary record to the performance records: field connectors

Following the SMF product section that relates to the performance records, and before the performance records themselves, is a string of **field connectors**. The field connectors connect each performance record field to the dictionary entry that describes it.

The purpose of the field connectors is to tell you which fields are going to occur in the performance records produced by this CICS run. Each field connector corresponds to one field in each of the succeeding performance records. The first field connector corresponds to the first field, the second to the second field, and so on.

Each field connector also corresponds to a single dictionary entry in the associated dictionary record: the connector value is equal to the value of CMODCONN in the corresponding dictionary entry. A useful technique for calculating the offset of a particular dictionary entry is to take the connector, subtract one, and multiply the result by the length of a single dictionary entry.

Thus, the string of field connectors is the key to the dictionary. And without the dictionary, reporting and analysis programs cannot interpret the performance data.

The successive performance records can be regarded as rows in a table, with each column corresponding to one type of field within the records. Each field connector then describes the contents of one column. This view of the data is helpful when designing tabular reports, which are often arranged in this way.



Figure 114 illustrates the relationship between the dictionary record, the field connectors, and the performance records.

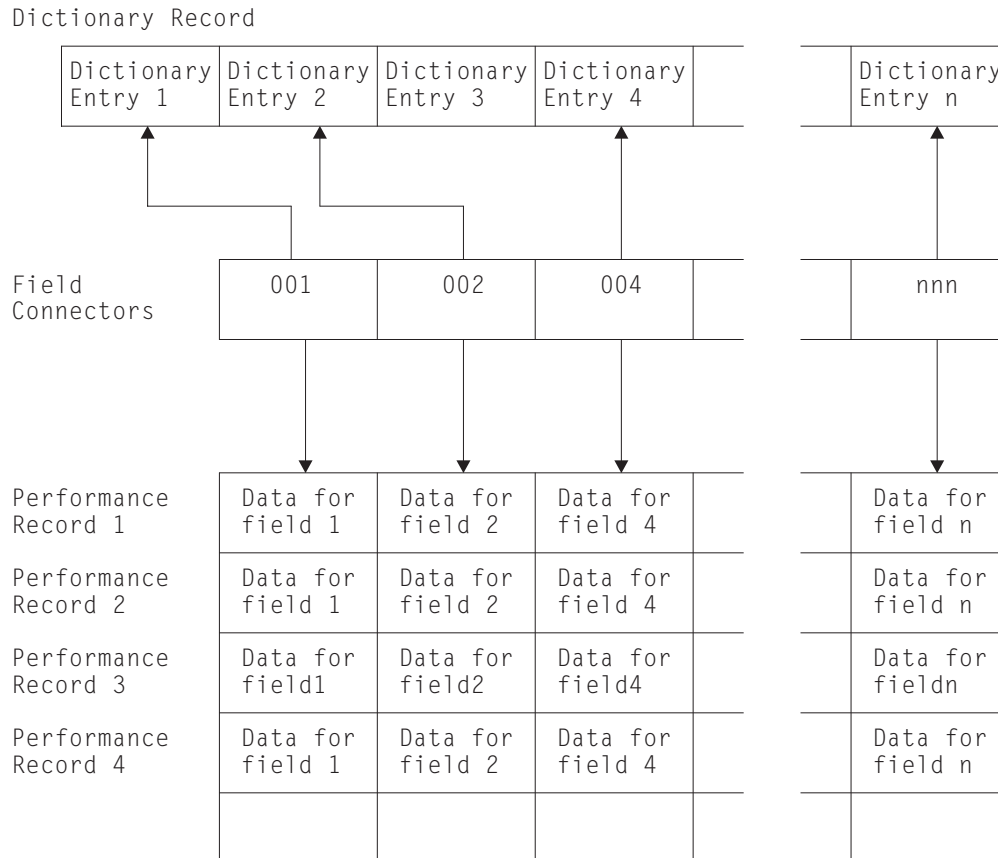

Figure 114. Relationship between the dictionary record and the performance records. In this example, the data that is defined by Dictionary Entry 3 has been excluded, so there is no field connector value for it and it does not appear in the performance records.

### How the string of field connectors is constructed

When CICS is initialized, a unique connector value is assigned to every dictionary entry. CICS then examines the MCT entries for this run to see if you have excluded any system-defined performance data. If you have, the offset values for their corresponding dictionary entries are set to X'FFFF'. CICS then constructs a sequence of field connectors that excludes those with offsets of X'FFFF'. In this way, the connectors tell you which system- and user-data fields are going to occur in your performance records for this run. If you have not excluded any system-defined performance data, there is one field connector for every dictionary entry.

Note the difference between field connectors, field identifiers, and field offsets:

#### Field connectors

link the fields in a performance record with their dictionary entries. They are unique values that are assigned at initialization time. They may, therefore, change from one run of CICS to the next.

#### Field identifiers

allow you to exclude specific system-defined performance data from being collected during a CICS run. They are unique within a group name and

record type, and they do **not** change between CICS runs. There is more information about field identifiers in the *CICS Resource Definition Guide*.

### Field offsets

in the performance record allow you to build a table for fast selection of required fields in your monitoring data processing programs.

### Exception data sections

The exception data section contains a single exception record representing one exception condition.

The format of an exception data record (including the SMF header and SMF product section) is shown in Figure 115.

SMF Header	SMF Product Section	Exception Data Section
---------------	------------------------	---------------------------

Figure 115. Format of an SMF exception data record

The format of the exception data section can be mapped by the DSECT MNEXCDS, which you can generate using the DFHMNEXC macro as follows:

```
MNEXCDS DFHMNEXC PREFIX=EXC
```

The label 'MNEXCDS' is the default DSECT name, and EXC is the default PREFIX value, so you could also generate the DSECT simply by coding

```
DFHMNEXC
```

The MNEXCDS DSECT has the format shown in Figure 116 on page 765.

```

MNEXCDS DSECT
EXCMNTRN DS CL4 TRANSACTION IDENTIFICATION
EXCMNTER DS XL4 TERMINAL IDENTIFICATION
EXCMNUSR DS CL8 USER IDENTIFICATION
EXCMNTST DS CL4 TRANSACTION START TYPE
EXCMNSTA DS XL8 EXCEPTION START TIME
EXCMNSTO DS XL8 EXCEPTION STOP TIME
EXCMNTNO DS PL4 TRANSACTION NUMBER
EXCMNTPR DS XL4 TRANSACTION PRIORITY
DS CL4 RESERVED
EXCMNLUN DS CL8 LUNAME
DS CL4 RESERVED
EXCMNEXN DS XL4 EXCEPTION NUMBER
EXCMNRTY DS CL8 EXCEPTION RESOURCE TYPE
EXCMNRID DS CL8 EXCEPTION RESOURCE ID
EXCMNTYP DS XL2 EXCEPTION TYPE
EXCMNWT EQU X'0001' WAIT
EXCMNBWT EQU X'0002' BUFFER WAIT
EXCMNSWT EQU X'0003' STRING WAIT
DS CL2 RESERVED
EXCMNTCN DS CL8 TRANSACTION CLASS NAME
EXCMNSRV DS CL8 SERVICE CLASS NAME
EXCMNRPT DS CL8 REPORT CLASS NAME
EXCMNNPX DS CL20 NETWORK UNIT-OF-WORK PREFIX
EXCMNNSX DS XL8 NETWORK UNIT-OF-WORK SUFFIX
EXCMNTRF DS XL8 TRANSACTION FLAGS
EXCMNFCN DS CL4 TRANSACTION FACILITY NAME
EXCMNCPN DS CL8 CURRENT PROGRAM NAME
EXCMNBTR DS CL4 BRIDGE TRANSACTION ID
EXCMNURI DS XL16 RRMS/MVS UNIT OF RECOVERY ID
EXCMNRIL DS F EXCEPTION RESOURCE ID LENGTH
EXCMNRIX DS XL256 EXCEPTION RESOURCE ID (EXTENDED)
EXCMNID DS CL8 NETWORK ID
EXCMNRLU DS CL8 REAL LUNAME
END OF EXCEPTION RECORD...

```

Figure 116. CICS monitoring exception record DSECT

For further information about exception class data, see Exception class data, in the *CICS Performance Guide*, which lists all the system-defined data that can be produced by CICS monitoring.

### Transaction resource data sections

Each transaction resource data section is made up of one or more transaction resource data records. Transaction resource records are produced at termination of the transaction for which the data is being collected.

All the transaction resource data records produced by a single CICS run have the same format, with a resource record header followed by a resource data section for each resource being monitored. The records are therefore variable length, depending on the number of resources for which data is being collected. For example, one transaction might access only 1 file, whereas another might access 5 files and 2 temporary storage queues.

For only one resource, either a file or a temporary storage queue, the record length is 188 bytes plus 96 bytes for the file or temporary storage queue data, giving a total of 284 bytes. Each additional file or temporary storage queue being monitored adds another 96 bytes.

You can collect transaction resource data for up to a maximum of 64 files, and 64 temporary storage queues. The FILE and TSQUEUE parameters on the DFHMCT TYPE=INITIAL macro set limits to the numbers of files and temporary storage

queues for which resource data can be collected for any one transaction. For example, if you specify FILE=10 in the DFHMCT TYPE=INITIAL macro, the file resource data section can have up to 960 bytes of file resource data.

All the system-defined data fields in the transaction resource monitoring records are described in [http://winlnx0c.hursley.ibm.com:19000/help/index.jsp?topic=/com.ibm.cics.ts.performance.doc/topics/dfht3\\_mon\\_tranmnr\\_fields.html#dfht35m](http://winlnx0c.hursley.ibm.com:19000/help/index.jsp?topic=/com.ibm.cics.ts.performance.doc/topics/dfht3_mon_tranmnr_fields.html#dfht35m) , in the *CICS Performance Guide*.

The format of the transaction resource monitoring records is shown in Figure 117.

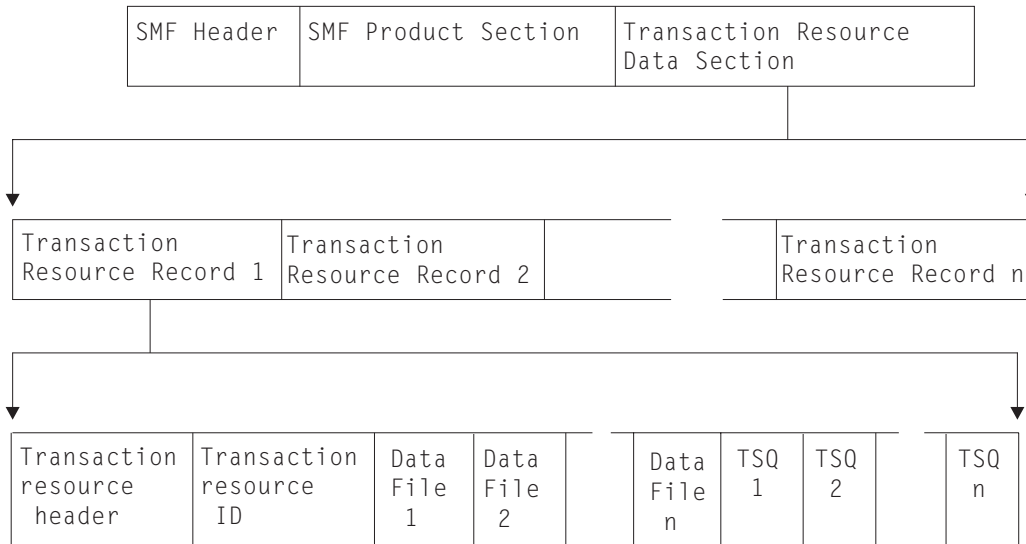

Figure 117. Format of the resource monitoring data section

You can map the transaction resource data section using the DFHMNRDS copybook, details of which are shown in Figure 118 on page 767.

DFHMNRDS DSECT	,	Transaction resource monitoring record
MNR_LENGTH	DS H	Length of resource data
MNR_ID_EQUATE	EQU 79	Monitoring domain id mask
MNR_ID	DC AL2(MNR_ID_EQUATE)	Monitoring domain id
MNR_VERSION	EQU X'02'	DSECT version mask
MNR_DSECT_VERS	DS CL1	DSECT version number
	DS CL3	Reserved
*		
MNR_HEADER	DS 0XL40	Header Data
MNR_HDRLEN	DS H	Length of header data
	DS XL2	Reserved
	DS XL8	Reserved
MNR_TRN	DS H	Number of record triplets
	DS XL2	Reserved
MNR_ISO	DS XL4	Offset to ID data
MNR_ISL	DS XL2	Length of ID entry
MNR_ISN	DS XL2	Number of ID entries
MNR_FSO	DS XL4	Offset to File data
MNR_FSL	DS XL2	Length of File entry
MNR_FSN	DS XL2	Number of File entries
MNR_TSO	DS XL4	Offset to TSQueue data
MNR_TSL	DS XL2	Length of TSQueue entry
MNR_TSN	DS XL2	Number of TSQueue entries
MNR_HDR_LENGTH	EQU *-MNR_HEADER	Header data length
	SPACE ,	
MNR_ID_DATA	DSECT	Identification Data Entry
MNR_ID_TRANID	DS CL4	Transaction id
MNR_ID_TERMID	DS CL4	Terminal id
MNR_ID_USERID	DS CL8	User id
MNR_ID_STYPE	DS CL4	Transaction Start type
MNR_ID_START	DS XL8	Transaction Start time
MNR_ID_STOP	DS XL8	Transaction Stop time
MNR_ID_TASKNO	DS XL4	Transaction Sequence Number
MNR_ID_LUNAME	DS CL8	VTAM Luname
MNR_ID_PGMNAME	DS CL8	First program name
MNR_ID_UOW_PX	DS XL20	Network Unit-of-Work Prefix
MNR_ID_UOW_SX	DS XL8	Network Unit-of-Work Suffix
MNR_ID_RSYSID	DS CL4	Remote sysid routed to
MNR_ID_TRN_FLAGS	DS XL8	Transaction flags
MNR_ID_FCTYNAME	DS CL4	Transaction Facility name
MNR_ID_RTYPE	DS CL4	Resource Record Type
MNR_ID_TERMINFO	DS 0XL4	Terminal Information
MNR_ID_NATURE	DS XL1	Nature
MNR_ID_NATURE_NOTAPPLIC	EQU X'00'	Not applic
MNR_ID_NATURE_TERMINAL	EQU X'01'	Terminal
MNR_ID_NATURE_SESSION	EQU X'02'	Session
MNR_ID_SESSTYPE	DS XL1	Session Type
MNR_ID_SESSTYPE_NOTAPPLIC	EQU X'00'	Not applic
MNR_ID_SESSTYPE_IRC	EQU X'01'	IRC
MNR_ID_SESSTYPE_IRC_XM	EQU X'02'	IRC XM
MNR_ID_SESSTYPE_IRC_XCF	EQU X'03'	IRC XCF
MNR_ID_SESSTYPE_LU61	EQU X'04'	LU61
MNR_ID_SESSTYPE_LU62_SING	EQU X'05'	LU62 SINGLE
MNR_ID_SESSTYPE_LU62_PARA	EQU X'06'	LU62 PARALLEL
MNR_ID_ACMETH	DS XL1	Access method
MNR_ID_ACMETH_NOTAPPLIC	EQU X'00'	Not applic
MNR_ID_ACMETH_VTAM	EQU X'01'	VTAM
MNR_ID_ACMETH_BSAM	EQU X'03'	BSAM

Figure 118. CICS transaction resource monitoring record DSECT (part 1)

MNR_ID_ACMETH_TCAM	EQU X'04'	TCAM/DCB (supported for remote terminals only)
MNR_ID_ACMETH_BGAM	EQU X'06'	BGAM
MNR_ID_ACMETH_CONSOLE	EQU X'07'	CONSOLE
MNR_ID_DEVCODE	DS XL1	Device type code
*		See TYPETERM RDO attribute
MNR_ID_TERMCNNM	DS CL4	Terminal Connection name
MNR_ID_RES_FLAGS	DS 0XL4	Resource flags
MNR_ID_RES_FLAG1	DS XL1	Resource flag 1
MNR_FILE_LIMIT_EXCEEDED	EQU X'80'	Resource File limit exceeded
MNR_TSQUEUE_LIMIT_EXCEEDED	EQU X'40'	Resource TSQueue limit exceeded
	DS XL3	Reserved
MNR_ID_ISIPCNNM	DS XL8	IPIC connection name
	DS XL8	Reserved
	DS XL8	Reserved
MNR_ID_LENGTH	EQU *-MNR_ID_DATA	Identification entry data length
	SPACE ,	
MNR_FILE_ENTRY	DSECT	File Entry
MNR_FILE_NAME	DS CL8	File name
MNR_FILE_GET	DS XL8	File Get time/count
MNR_FILE_PUT	DS XL8	File Put time/count
MNR_FILE_BRWSE	DS XL8	File Browse time/count
MNR_FILE_ADD	DS XL8	File Add time/count
MNR_FILE_DEL	DS XL8	File Delete time/count
MNR_FILE_TOTAL	DS XL8	File Total time/count
MNR_FILE_AM_RQ	DS XL4	File Access Method request count
	DS XL4	Reserved
MNR_FILE_IO_WT	DS XL8	File I/O wait time
MNR_RLS_FILE_IO_WT	DS XL8	RLS File I/O wait time
MNR_CFDI_IO_WT	DS XL8	CFDI I/O wait time
	DS XL8	Reserved
MNR_FILE_LEN	EQU *-MNR_FILE_ENTRY	File entry data length
	SPACE ,	
MNR_TSQUEUE_ENTRY	DSECT	TSQueue Entry
MNR_TSQUEUE_NAME	DS CL16	TSQueue Name
MNR_TSQUEUE_GET	DS XL8	TSQueue Get time/count
MNR_TSQUEUE_PUT_AUX	DS XL8	TSQueue Put Aux time/count
MNR_TSQUEUE_PUT_MAIN	DS XL8	TSQueue Put Main time/count
MNR_TSQUEUE_TOTAL	DS XL8	TSQueue Total time/count
	DS XL4	Reserved
MNR_TSQUEUE_GET_ITEML	DS XL4	TSQueue Get Item length
MNR_TSQUEUE_PUT_AUX_ITEML	DS XL4	TSQueue Put Aux Item length
MNR_TSQUEUE_PUT_MAIN_ITEML	DS XL4	TSQueue Put Main Item length
	DS XL8	Reserved
MNR_TSQUEUE_IO_WT	DS XL8	TSQueue I/O wait time
MNR_SHR_TSQUEUE_IO_WT	DS XL8	Shared TSQueue I/O wait time
	DS XL8	Reserved
MNR_TSQUEUE_LEN	EQU*-MNR_TSQUEUE_ENTRY	TSQueue entry data length

Figure 119. CICS transaction resource monitoring record DSECT (part 2)

---

## Chapter 29. Writing statistics collection and analysis programs

This chapter describes how you can customize the collection and analysis of CICS statistics. It is divided into the following sections:

1. “Writing a program to collect CICS statistics” describes how user programs can use EXEC CICS commands to collect statistics and reset statistics counters.
2. “CICS statistics record format” on page 771 describes the format of CICS statistics SMF type 110 records. You need this information if you write your own statistics analysis program.
3. “Using an XSTOUT global user exit program to filter statistics records” on page 776 suggests how you can use the global user exit in the CICS statistics domain.
4. “Processing the output from CICS statistics” on page 777 lists the methods of processing statistics data.

---

### Writing a program to collect CICS statistics

#### Background information

CICS statistics contain information about the CICS system as a whole—for example, its performance and usage of resources. Statistics data is therefore useful both for performance tuning and for capacity planning.

Statistics are collected during CICS online processing for later offline analysis. The statistics domain writes statistics records to a System Management Facility (SMF) data set. The records are of SMF type 110, subtype 0002.

**Note:** Monitoring records, and statistics records produced by the temporary storage shared-queue server, are also written to the SMF data set as type 110 records. (Some journaling type 110 records can be written there, too.) You might find it useful to process the statistics records and the monitoring records together, because statistics provide resource and system information that is complementary to the transaction data produced by CICS monitoring.

Statistics records are also written by:

- Temporary storage (TS) data sharing pool server regions. These records are of SMF type 110, subtype 0003.
- Coupling facility data table (CFDT) server regions. These records are of SMF type 110, subtype 0004.
- Named counter sequence number server regions. These records are of SMF type 110, subtype 0005.

CICS produces five types of statistics: **interval**, **end-of-day**, **requested**, **requested reset**, and **unsolicited**.

#### Important

For detailed information about the types of CICS statistics, when they are collected, and how to control their collection, see Introduction to CICS statistics, in the *CICS Performance Guide*.

## Resetting statistics counters

Statistics counters are reset in the following circumstances:

- At CICS startup
- When interval statistics are written (but **not** when an interval occurs and no statistics are written)
- At end of day
- When requested reset statistics are written.

However, you can cause statistics counters to be reset without writing records to the SMF data set. You do this by changing the statistics recording status, using either of the commands:

- CEMT SET STATISTICS ONIOFF RESETNOW
- EXEC CICS SET STATISTICS ONIOFF RESETNOW.

Thus, a user program can reset all statistics counters by issuing an EXEC CICS SET STATISTICS RESETNOW command.

Note that it is valid to specify the RESETNOW option only when there is a genuine change of recording status. For example, coding EXEC CICS SET STATISTICS ON RESETNOW when STATISTICS is already set ON causes an error response.

### Important

Statistics counters are reset in various ways. Specific counters may be reset to:

- 0
- 1
- A new peak value
- Not reset
- None of the above.

For information about the resetting of specific statistics counters, refer to Resetting statistics counters, in the *CICS Performance Guide*.

## Using the EXEC CICS COLLECT and EXTRACT STATISTICS commands

The statistics collected by CICS are written to an SMF data set. However, a user program can use the **EXEC CICS COLLECT STATISTICS** and **EXEC CICS EXTRACT STATISTICS** commands to collect the current statistics for a particular resource, or overall statistics for the resources of a particular type.

For example, you can get the statistics for global transaction activity in your CICS region (such as the total number of transactions attached), or you can specify a single transaction that you are interested in (such as CEMT). The statistics are returned to the invoking application. For programming information about the **EXEC CICS COLLECT STATISTICS** and **EXEC CICS EXTRACT STATISTICS** commands, see the *CICS System Programming Reference*.

CICS supplies eleven sample programs that show how you can use the **EXEC CICS COLLECT STATISTICS**, **EXEC CICS EXTRACT STATISTICS**, and **EXEC CICS INQUIRE** commands to produce a useful analysis of a CICS system. These are:

- DFHOSTAT
- DFHOSTDB
- DFHOSTEJ



- DFH0STGN
- DFH0STLK
- DFH0STPR
- DFH0STSY
- DFH0STTP
- DFH\$STAS
- DFH\$STCN
- DFH\$STTB

The sample programs produce a report showing critical system parameters from the CICS dispatcher, together with loader statistics and an analysis of the CICS storage manager. DFH\$STAS, DFH\$STCN, and DFH\$STTB are provided in assembler language; the other eight programs are provided in COBOL.

For information about installing and operating the sample statistics programs, and about the data produced by the programs, see the *CICS Performance Guide*.

---

## CICS statistics record format

This section describes the format of CICS statistics SMF type 110 records in detail. You need this information if you write your own program to analyze the statistics data. The three components of a CICS statistics record are an SMF header, an SMF product section, and a CICS data section, as shown in Figure 120. Each of these is described in the sections that follow.

SMF Header	SMF Product Section	CICS Data Section
------------	---------------------	-------------------

Figure 120. Format of an SMF type 110 statistics record

### SMF header and SMF product section

The SMF header describes the system creating the output. The SMF product section identifies the subsystem to which the statistics data relates, which, in the case of CICS statistics, is the CICS region, the TS data sharing server, the CFDT server, or the named counter sequence number server. Both the SMF header and the SMF product section can be mapped by the DSECT STSMFDS, which you can generate using the DFHSTSMF macro as follows:

```
STSMFDS DFHSTSMF PREFIX=SMF
```

The label 'STSMFDS' is the default DSECT name, and SMF is the default PREFIX value, so you could also generate the DSECT simply by coding DFHSTSMF.

The STSMFDS DSECT has the format shown in Figure 121 on page 772.

```

*          START THE SMF HEADER
*
STSMFDS  DSECT
SMFSTLEN DS   XL2          RECORD LENGTH
SMFSTSEQ DS   XL2          SEGMENT DESCRIPTOR
SMFSTFLG DS   X           OPERATING SYSTEM INDICATOR (see note 1)
SMFSTRTY DC   X'6E'       RECORD TYPE 110 FOR CICS
SMFSTTME DS   XL4          TIME RECORD MOVED TO SMF
SMFSTDTE DS   XL4          DATE RECORD MOVED TO SMF
SMFSTSID DS   XL4          SYSTEM IDENTIFICATION
SMFSTSSI DS   CL4'CICS'    SUBSYSTEM IDENTIFICATION
SMFSTSTY DS   XL2          RECORD SUBTYPE X'0002' FOR STATISTICS
*                                     (see note 4)
SMFSTTRN DS   XL2          NUMBER OF TRIPLETS
          DS   XL2          RESERVED
SMFSTAPS DS   XL4          OFFSET TO PRODUCT SECTION
SMFSTLPS DS   XL2          LENGTH OF PRODUCT SECTION
SMFSTNPS DS   XL2          NUMBER OF PRODUCT SECTIONS
SMFSTASS DS   XL4          OFFSET TO DATA SECTION
SMFSTASL DS   XL2          LENGTH OF DATA SECTION
SMFSTASN DS   XL2          NUMBER OF DATA SECTIONS
*
*          THIS CONCLUDES THE SMF HEADER
*
*          START THE SMF PRODUCT SECTION
*
SMFSTRVN DS   XL2          RECORD VERSION
SMFSTPRN DS   CL8          PRODUCT NAME (GENERIC APPLID)
SMFSTSPN DS   CL8          PRODUCT NAME (SPECIFIC APPLID)
SMFSTMFL DS   XL2          RECORD MAINTENANCE INDICATOR
          DS   XL2          RESERVED
          DS   XL2          RESERVED
SMFSTDTK DS   XL4          DOMAIN TOKEN
SMFSTDID DS   CL2          DOMAIN ID
SMFSTRQT DS   CL3          USS/EOD/REQ/INT STATISTICS TYPE
SMFSTICD DS   CL3          YES IF INCOMPLETE DATA RECORDED
SMFSTDAT DS   CL8          COLLECTION DATE MMDDYYYY
SMFSTCLT DS   CL6          COLLECTION TIME HHMMSS
SMFSTINT DS   CL6          INTERVAL HHMMSS. See note 3.
SMFSTINO DS   XL4          INTERVAL NUMBER. See note 3.
SMFSTRTK DS   XL8          REQUEST TOKEN
SMFSTLRT DS   CL6          LAST RESET TIME HHMMSS
SMFSTCST DS   XL8          CICS START TIME
SMFSTJBN DS   CL8          JOBNAME
SMFSTRSD DS   XL4          JOB DATE
SMFSTRST DS   XL4          JOB TIME
SMFSTUIF DS   CL8          USER IDENTIFICATION
SMFSTPDN DS   CL8          OPERATING SYSTEM PRODUCT LEVEL
*
*          THIS CONCLUDES THE SMF PRODUCT SECTION

```

Figure 121. Format of the SMF header and product section for statistics records

**Note:**

1. CICS sets only the subsystem-related bits of the operating system indicator flag byte in the SMF header (SMFSTFLG). SMF sets the remainder of the byte according to the operating system level and other factors. For an explanation of the setting of the other bits, refer to the *z/OS MVS System Management Facilities (SMF)* manual.
2. The copy book DFHSMFDS is also provided and can be used to map the SMF header and the SMF product sections of all six subtypes of SMF 110 records written by CICS journaling, CICS monitoring, and CICS statistics.

3. Fields SMFSTINT and SMFSTINO are only relevant if SMFSTRQT is 'INT'. Otherwise both values should be ignored.
4. For TS data sharing, the record subtype is X'0003' and certain fields are not set or are used in a different way. SMFSTPRN and SMFSTSPN contain the server prefix (DFHXQ) and the pool name.
5. For coupling facility data table (CFDT) servers, the record subtype is X'0004' and certain fields are not set or are used in a different way. SMFSTPRN and SMFSTSPN contain the server prefix (DFHCF) and the coupling facility data table pool name.
6. For named counter sequence number servers, the record subtype is X'0005' and certain fields are not set or are used in a different way. SMFSTPRN and SMFSTSPN contain the server prefix (DFHNC) and the pool name.

## CICS statistics data section

The format of the CICS statistics data section is shown in Figure 122. If the data records are incomplete, the flag field SMFSTICD is set to 'YES'. In this

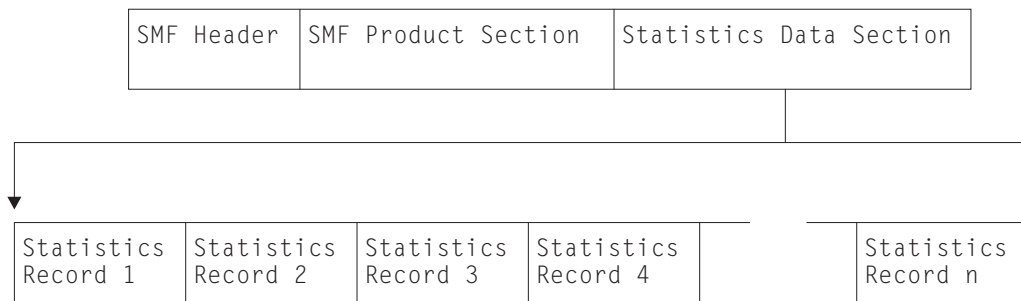

Figure 122. Format of the statistics data section

case, the statistics data section is not present.

For complete data records, the statistics data section is made up of one or more statistics data records. There are different formats of data records. Each has a common format for the first 5 bytes. These 5 bytes are described in the extract from copy book DFHSTIDS in Figure 123.

DFHSTIDS	DSECT		Statistics record header
*			
	DS	0F	Fullword alignment
STILEN	DS	H	Length of the record
STID	DS	AL2	Statistics identifier
STIVERS	DS	CL1	Statistics record version

Figure 123. Extract from copy book DFHSTIDS

### STILEN

is the length of the data record.

### STID

identifies which type of statistics record you have (see Figure 124 on page 775).

You can use the STID symbolic name or value to determine which copy book to use when processing the statistics data records. For details about the relationship between the STID name or value and the copy book, see

Figure 124 on page 775. For further guidance information about the fields within the statistics data records, see CICS statistics in DSECTs and DFHSTUP report, in the *CICS Performance Guide*.

**STIVERS**

takes the value '1' for this release of CICS.

STID Symbolic name	STID Value	Copy book	Type of record
STISMD	5	DFHSMDDS	Storage mgr domain subpool id
STISMT	6	DFHSMTDS	Storage manager task subpool id
STIXMG	10	DFHXMGDS	Transaction manager (Globals) id
STIXMR	11	DFHXRDS	Transaction manager (Trans) id
STIXMC	12	DFHXMCD	Transaction manager (Tclass) id
STISMDSA	14	DFHSMDS	Storage manager DSA id
STIFEPIP	16	DFHA22DS	FEPI pool id
STIFEPIP	17	DFHA23DS	FEPI connection id
STIFEPIP	18	DFHA24DS	FEPI target id
STIVT	21	DFHA03DS	VTAM stats id
STIPAUTO	23	DFHPGGDS	Program Autoinstall id
STIAUTO	24	DFHA04DS	Terminal Autoinstall stats id
STILDR	25	DFHLDRDS	Loader (Resid) id
STIDBUSS	28	DFHDBUDS	DBCTL USS id
STILDG	30	DFHLDGDS	Loader (Globals) id
STITCR	34	DFHA06DS	Terminal control (resid) id
STILSRR	39	DFHA08DS	LSRPOOL pool stats (resid) id
STILSRFR	40	DFHA09DS	LSRPOOL File statistics (by file)
STITDQR	42	DFHTQRDS	TDQUEUE (Resid) id
STITDQG	45	DFHTQGDS	TDQUEUE (globals) id
STITSQ	48	DFHTSGDS	TSQUEUE statistics id
STICONSR	52	DFHA14DS	ISC/IRC system entry (resid) id
STICONSS	54	DFHA21DS	ISC connection - system security
STIDS	60	DFHDSGDS	Dispatcher stats id
STIUSG	61	DFHUSGDS	User domain stats id
STITM	63	DFHA16DS	Table manager statistics id
STIDST	64	DFHDSTDS	Dispatcher TCB (global)id
STIDSR	65	DFHDSRDS	Dispatcher TCB (resid)id
STIST	66	DFHSTGDS	Statistics statistics id
STIFCR	67	DFHA17DS	File Control (resid) id
STIMQG	74	DFHMQGDS	MQ connection stats (global) id
STICONMR	76	DFHA20DS	ISC/IRC mode entry (resid) id
STIM	81	DFHMNGDS	Monitoring stats (global) id
STIMNR	84	DFHMNTDS	Monitoring stats (Resid) id
STITDR	85	DFHTDRDS	Transaction dump (resid) id
STITDG	87	DFHTDGDS	Transaction dump (global) id
STISDR	88	DFHSDRDS	System dump (resid) id
STISDG	90	DFHSDGDS	System dump (global) id
STILGG	92	DFHLGGDS	Logstream stats (global) id
STILGR	93	DFHLGRDS	Logger stats (resid) id
STILGS	94	DFHLGSDS	Logstream stats (resid) id
STINQG	97	DFHNQGDS	Enqueue mgr stats (global) id
STIRMG	99	DFHRMGDS	Recovery mgr stats (global) id
STIWBG	101	DFHWBGDS	URIMAPs (global) id
STID2G	102	DFHD2GDS	DB2 connection stats (global) id
STID2R	103	DFHD2RDS	DB2 entry stats (resource) id
STIWRB	104	DFHWBRDS	URIMAPs (resource) id
STIPIR	105	DFHPIRDS	PIPELINE (resource) id
STIPIW	106	DFHPIWDS	WEBSERVICE (resource) id
STISOG	107	DFHSOGDS	TCP/IP (global) id
STISOR	108	DFHSORDS	TCPIP services (resource) id
STIISR	109	DFHISRDS	IPCONN (resource) id
STIIIR	111	DFHIIRDS	REQUESTMODEL (resource) id
STIDHD	112	DFHDHDDS	DOCTEMPLATE (resource) id
STIEJR	114	DFHEJRDS	CORBA Server (resource) id
STIEJB	115	DFHEJBDS	Bean stats (resource) id
STISJG	117	DFHSJGDS	JVMPPOOL stats (global) id
STISJR	118	DFHSJRDS	JVMPROFILE stats (resource) id
STIPGR	119	DFHPGRDS	JVMPROGRAM stats (Resource) id

Figure 124. Statistics data record copy books related to STID name and value

The TS data sharing statistics use no symbolic names, but relate to the STID values as follows:

STID Symbolic name	STID Value	Copy book	Type of record
-	121	DFHXQS1D	TS server list structure stats id
-	122	DFHXQS2D	TS buffer stats id
-	123	DFHXQS3D	TS storage stats id

Figure 125. TS data sharing statistics related to STID

The coupling facility data table server statistics use no symbolic names, but relate to the STID values as follows:

STID Symbolic name	STID Value	Copy book	Type of record
-	126	DFHCFS6D	CFDT server list stats
-	127	DFHCFS7D	CFDT buffer stats id
-	128	DFHCFS8D	CFDT request stats id
-	129	DFHCFS9D	CFDT storage stats id

Figure 126. Coupling facility data table server statistics related to STID

The named sequence number server statistics use no symbolic names, but relate to the STID values as follows:

STID Symbolic name	STID Value	Copy book	Type of record
-	124	DFHNCS4D	NC server list structure stats id
-	125	DFHNCS5D	NC server storage stats id

Figure 127. Named sequence server statistics related to STID

---

## Using an XSTOUT global user exit program to filter statistics records

There is one global user exit point (XSTOUT) in the CICS statistics domain. The exit is invoked before the contents of a statistics data buffer are written to SMF. At this exit, the following information is available:

- The address of the statistics buffer
- The length of the statistics buffer
- The address of the statistics type.

This applies to all five types of statistics: interval, end-of-day, requested, requested reset, and unsolicited statistics.

If you write a global user exit program to be invoked at this exit, you can examine this information and tell CICS either to write the contents of the buffer to SMF or to suppress its output.

For more information about global user exits in general, and about the statistics exit in particular, refer to Chapter 1, “Global user exit programs,” on page 3.

---

## Processing the output from CICS statistics

There are several utilities to help you process statistics output:

### **The CICS-supplied DFHSTUP program**

For information about how to run DFHSTUP, refer to the *CICS Operations and Utilities Guide*. For information about how to interpret the report produced by DFHSTUP, see the *CICS Performance Guide*.

### **Tivoli® Decision Support for z/OS**

This tool enables you to store CICS statistics and other data into a DB2 data set, and to present the data in a variety of forms. For more information, see the *CICS Performance Guide*.

### **Your own program**

Write your own program to report and analyze the data in the statistics records. The format of CICS statistics records is described in “CICS statistics record format” on page 771.





---

## Part 6. Customizing CICS compatibility interfaces

### **A general note about user-written programs:**

The following comment applies to all user-written programs mentioned in Part 6 of this book:

- Upon return from any customer-written program, CICS must always receive control in primary-space translation mode, with the original contents of all access registers restored, and with all general purpose registers restored (except for those which provide return codes or linkage information).

For information about translation modes, refer to the *IBM ESA/370 Principles of Operation* manual.

---

## Chapter 30. The dynamic allocation sample program

This chapter suggests ways in which you can customize the dynamic allocation sample application program, used to allocate or deallocate data sets dynamically. It is divided into the following sections:

1. “Overview of the dynamic allocation program”
2. “Installing the program and transaction definitions” on page 782
3. “The dynamic allocation program—terminal operation” on page 782
4. “Using the dynamic allocation program’s Help feature” on page 782
5. “The dynamic allocation program—values” on page 783
6. “The flow of control when a DYNALLOC request is issued” on page 784.

---

### Overview of the dynamic allocation program

The dynamic allocation (DYNALLOC) sample application program makes available to the CICS terminal operator most of the functions of DYNALLOC (SVC 99). These functions are described fully in the *MVS/ESA SPL: Application Development Guide*. Functions that require authorized program facility (APF) authorization are not supported.

The application consists of one command-level assembler-language program, DFH99, which is invoked by the transaction ADYN. The source code is provided in CICSTS32.CICS.SDFHSAMP.

Using DYNALLOC functions, the terminal operator can dynamically allocate or deallocate any data set that CICS can open and close. With suitable operating discipline and CEMT commands, these can include:

- Extrapartition transient data sets
- Journals
- Dump and trace data sets.

You should **not** use the dynamic allocation program to allocate and deallocate data sets that are to be associated with files managed by file control. You should use the dynamic allocation and deallocation facility which is part of CICS. If a file has not been allocated as part of CICS startup, CICS dynamic allocation occurs immediately before the file is opened, if sufficient information is in the file control table. The information needed is the data set name and disposition of the file. This information is set by the CEMT SET FILE master terminal transaction, described in CEMT SET FILE, in the *CICS Supplied Transactions* manual, or the EXEC CICS INQUIRE FILE and EXEC CICS SET FILE commands, which provide additional inquiry and control facilities, and which are described in SET FILE, in the *CICS System Programming Reference* manual.

To use the dynamic allocation sample program effectively, the terminal operator should:

- Have an understanding of MVS job control language, or TSO ALLOCATE and FREE commands.
- Have read the relevant sections of the *MVS/ESA SPL: Application Development Guide* and have that manual available for reference while using the sample program, in particular for looking up error and reason codes returned by DYNALLOC.

The application uses a 3270 display screen terminal, and adjusts its formatting to suit the screen size. BMS is not required. The program is designed so that the installation can easily modify the functions supported to suit installation standards.

---

## Installing the program and transaction definitions

Transaction and program definitions for the dynamic allocation sample program are provided in the sample utilities group DFH\$UTIL on the CSD. These definitions are installed using the CEDA command:

```
CEDA INSTALL GROUP(DFH$UTIL)
```

**Note:**

1. DFH99 **must** be defined with EXECKEY(CICS).
2. If you make any changes to the sample program, you must run the DFH99BLD procedure before using the ADYN transaction.

---

## The dynamic allocation program—terminal operation

When transaction ADYN is entered at a terminal, the operator is presented with a formatted display. The top part of the display is for entering commands, the bottom part for receiving messages from the program.

The operator types a command in TSO-like syntax, for example,

```
verb {keyword[(value...)]}...
```

and presses the ENTER key. The program checks the command for correct syntax, builds a DYNALLOC parameter list, and, if no serious errors are detected, issues a DYNALLOC SVC. Messages are then displayed to diagnose syntax errors, give the DYNALLOC return codes, and show any values returned by DYNALLOC information retrieval features. The command remains on the display, and the editing features of the terminal can be used to correct it for reentry, or to enter a different command.

If there are too many messages to fit into the message area of the screen, messages that cannot be displayed are queued, and the messages already on the screen are displayed with a brighter intensity to indicate that there are more messages to come. The operator can correct those errors that are being displayed, and reenter the command for further checking, when the queued messages, if any, are regenerated.

The program is terminated by entering a null command, which consists of pressing the ERASE INPUT key, followed by the ENTER key. PA keys 1 and 2 are ignored by the program. If you press the CLEAR key, you redisplay the last command entered. Pressing a program function key is equivalent to pressing ENTER.

---

## Using the dynamic allocation program's Help feature

The program includes a limited "help" feature, driven by the program's keyword table.

In response to "?", the verb keywords are displayed. In response to "verb?", all the operand keywords of that verb are displayed. For "verb operand(?)" a short description of the value expected for that operand is displayed. When a command

containing “?” is entered, no DYNALLOC SVC is issued. “?” is recognized only in the positions specified above; the rest of the command is ignored.

---

## The dynamic allocation program—values

Values are classified as follows:

### **Keyword value**

Keyword values must be specified for some keywords. For example, the STATUS keyword may have a keyword value of SHR, NEW, MOD, or OLD (which can be abbreviated).

### **String of key letters**

The value can be a string of letters in any order. The program does not check that the combination of letters provided is meaningful. For example, for the RECFM keyword, the value can be a string of letters from A, B, D, F, G, M, R, S, T, U, and V.

### **Returned values**

No value should be provided by the terminal operator, because this keyword requests a value to be returned by the DYNALLOC information retrieval features. The further description refers to the kind of value that will be returned. This is usually in the form in which the operator would enter it, although in a few cases the value is as a hexadecimal string.

### **Not allowed**

Some keywords do not require a value, and you must not provide one.

### **Required**

A value must be provided if the keyword coded is designated as requiring a value.

### **Optional**

Specification of a value is optional for some keywords.

### **Single**

Only one value may be provided for some keywords.

### **Multiple**

For some keywords, more than one value is permitted. (In some cases, DYNALLOC requires more than one value, although the dynamic allocation sample program does not enforce this.)

### **Character string**

Any characters are permitted in this type of value, although in most cases there will be additional rules to follow, for example, for the DSNNAME keyword.

### **Numeric string**

Only numeric characters are allowed for this type of value, for example, for the EXPDT keyword.

### **Maximum and minimum lengths**

For character and numeric values, the maximum and minimum lengths of the value are checked by the program. For a fixed-length string, these values are the same. The value is still passed to DYNALLOC as specified.

### **Convertible to n byte binary**

A numeric value is required, of a magnitude representable in binary in the specified number of bytes. Values that are too large are truncated to the maximum possible for the width.

The dynamic allocation sample program does not support negative numbers. It does not cross-check operand keywords; errors of this type usually cause DYNALLOC to return error codes of the form 03xx.

## Abbreviation rules for keywords

Keywords can be abbreviated. A word in the command matches a keyword if:

- The spelling is the same.
- The first letter is the same, and the remaining letters in the word appear in the same order as they do in the keyword.

If an ambiguity occurs, the program diagnoses the ambiguity, and lists the possible keywords.

## System programming considerations

Keyword spellings are defined in the program's table, DFH99T, which is link-edited with the program. Where possible, these are the same as the corresponding job control or TSO keywords. Comments in the source code for DFH99T explain how the system programmer can:

- Change the spelling of keywords
- Define alternative spelling for keywords
- Divide the functions of a verb into subsets
- Add new verbs with subset function
- Add new operands as they become available in the SVC.

Member DFH99BLD in CICSTS32.CICS.SDFHINST is the job stream used to build the program. If part of the program has been modified, reassemble that part and link-edit the program again.

The macros IEFZB4D0 (DYNALLOC parameter list structure) and IEFZB4D2 (symbolic key equates), provided by MVS, are used in the dynamic allocation program and its keyword table. The meaning of each keyword in the table is defined in terms of a symbolic name, defined by one of the macros IEFZB4D0 or IEFZB4D2. The definitions of command keywords given in that manual should be regarded in preference to those from any other source. To obtain a list of command keywords and their symbolic values, for use as a cross-reference to the MVS manual, assemble DFH99T with option SYSPARM(LIST), and print the resulting object code. If the table is changed, repeat the assembly to obtain a new list.

---

## The flow of control when a DYNALLOC request is issued

The flow in a normal invocation is as follows. The main program, DFH99M, receives control from CICS and carries out initialization. This includes determining the screen size, allocating input and output buffer sections, and issuing initial messages. It then invokes DFH99GI to get the input command from the terminal. Upon return, if the command was null, the main program terminates, issuing a final message.

The command obtained has its start and end addresses stored in the global communication area, COMM. The main program allocates storage for tokenized text, and calls DFH99TK to tokenize the command. If errors were detected at this stage, further analysis of the command is bypassed.

Following successful tokenizing, the main program calls DFH99FP to analyze the verb keyword. DFH99FP calls DFH99LK to look up the verb keyword in the table, DFH99T. DFH99LK calls DFH99MT if an abbreviation is possible. Upon finding the matching verb, DFH99FP puts the address of the operand section of the table into COMM, and puts the function code into the DYNALLOC request block.

The main program now calls DFH99KO to process the operand keywords. Each keyword in turn is looked up in the table by calling DFH99LK, and the value coded for the keyword is checked against the attributes in the table. DFH99KO then starts off a text unit with the appropriate code and, depending on the attributes the value should have, calls a conversion routine.

For character and numeric strings, DFH99CC is called. It validates the string, and puts its length and value into the text unit.

For binary variables, DFH99BC is called. It validates the value, converts it to binary of the required length, and puts its length and value into the text unit.

For keyword values, DFH99KC is called. It looks up the value in the description part of the keyword table using DFH99LK, and puts the coded equivalent value and its length into the text unit.

When a keyword specifying a returned value is encountered, DFH99KO makes an entry on the returned value chain, which is anchored in COMM. This addresses the keyword entry in DFH99T, the text unit where the value is returned, and the next entry. In this case the conversion routine is still called, but it only reserves storage in the text unit, setting the length to the maximum and the value to zeros.

When all the operand keywords have been processed, DFH99KO returns to the main program, which calls DFH99DY to issue the DYNALLOC request.

DFH99DY sets up the remaining parts of the parameter list and, if no errors too severe have been detected, a subtask is attached to issue the DYNALLOC SVC. A WAIT EVENT is then issued against the subtask termination ECB. When the subtask ends and CICS dispatches the program again, the DYNALLOC return code is captured from the subtask ECB and the error and reason codes from the DYNALLOC request block and a message is issued to give these values to the terminal.

DFH99DY then returns to the main program, which calls DFH99RP to process returned values. DFH99RP scans the returned value chain, and for each element issues a message containing the keyword and the value found in the text unit. If a returned value corresponds to a keyword value, DFH99KR is called to look up the value in the description, and issue the message.

Processing of the command is now complete, and the main program is reinitialized for the next one, and loops back to the point where it calls DFH99GI.

Messages are issued at many places, using macros. The macro expansion ends with a call to DFH99MP, which ensures that a new line is started for each new message, and calls DFH99ML, the message editor. Input to the message editor is a list of tokens, and each one is picked up in turn and converted to displayable text. For each piece of text, DFH99TX is called, which inserts the text into the output buffer, starting a new line if necessary. This ensures that a word is never split over two lines.

At the end of processing the command, the main program calls DFH99MP with no parameters, which causes it to send the output buffer to the terminal, and initialize it to empty.



---

## Part 7. Customizing CICS security processing

### General notes:

The following comments apply to the chapters in Part 7 of this book:

- The only aspects of CICS security processing covered are:
  - Invoking a user-written external security manager.
  - Writing a “good night” transaction.

Customization of password expiry templates for HTTP basic authentication, which is an element of CICS Web support, is covered in the *CICS Internet Guide*. **For a comprehensive view of security processing using the Resource Access Control Facility (RACF) product, see the *CICS RACF Security Guide*.**

- Upon return from any customer-written program, CICS must always receive control in primary-space translation mode, with the original contents of all access registers restored, and with all general-purpose registers restored (except for those which provide return codes or linkage information).

For information about translation modes, refer to the *IBM ESA/370 Principles of Operation* manual.

---

## Chapter 31. Invoking an external security manager

CICS provides an interface to an external security manager (ESM), which may be the Resource Access Control Facility (RACF), a vendor product, or user-written. This chapter gives an overview of the CICS-ESM interface, and describes how you can use the MVS router exit to pass control to a user-written ESM. It describes how ESM exit programs can access CICS-related information. Finally, it lists the control points at which CICS invokes the ESM.

**Note that this chapter is intended primarily for non-RACF users. For definitive information about security processing using RACF, you should refer to Introduction to CICS security with RACF, in the *CICS RACF Security Guide*.**

The chapter is divided into the following sections:

1. “An overview of the CICS-ESM interface”
2. “The MVS router”
3. “Using ESM exit programs to access CICS-related information” on page 791
4. “CICS security control points” on page 796
5. “Using early verification processing” on page 797.

---

### An overview of the CICS-ESM interface

CICS security uses, via the RACROUTE macro, the MVS system authorization facility (SAF) interface to route authorization requests to the ESM. Normally, if RACF is present, the MVS router passes control to it. However, you can modify the action of the MVS router by invoking the router exit. The router exit can be used, for example, to pass control to a user-written or vendor-supplied ESM. (If you want to use your own security manager, you **must** supply an MVS router exit routine.)

The control points at which CICS issues a RACROUTE macro to route authorization requests are described in “CICS security control points” on page 796.

---

### The MVS router

SAF provides your installation with centralized control over security processing, by using a system service called the MVS router. The MVS router provides a common system interface for all products providing resource control. The resource-managing components and subsystems (such as CICS) call the MVS router as part of certain decision-making functions in their processing, such as access control checking and authorization-related checking. These functions are called **control points**. This single SAF interface encourages the use of common control functions shared across products and across systems.

If RACF is available in the system, the MVS router may pass control to the RACF router, which in turn invokes the appropriate RACF function. (The parameter information and the RACF router table, which associates router invocations with RACF functions, determine the appropriate function.) However, before calling the RACF router, the MVS router calls an optional, installation-supplied security-processing exit, if one has been installed.

### The MVS router exit

The MVS router provides an optional installation exit that is invoked whether or not RACF is installed and active on the system. If your installation does not use RACF,

you can use the router exit to pass control to your own ESM. If you do use RACF, you could use the exit for preprocessing before RACF is invoked.

The MVS router exit routine is invoked whenever CICS (or another component of your system) issues a RACROUTE macro. The router passes a parameter list (generated by the RACROUTE macro) to the exit routine. In addition, the exit receives the address of a 150-byte work area.

On entry to the exit routine, register 1 contains the address of the area described in Table 43.

Table 43. Area addressed by register 1, on entry to exit routine

Offset	Length	Description
0	4	<b>Parameter list address:</b> points to the MVS router parameter list. (See “The MVS router parameter list.”)
4	4	<b>Work area address:</b> points to a 150-byte work area that the exit can use.

The exit must be named ICHRTX00 and must be located in the link pack area (LPA).

**Note:** During signon processing, CICS Transaction Server for z/OS, Version 3 Release 2 issues the RACROUTE REQUEST=VERIFY macro with the ENVIR=VERIFY option, in problem-program state. (For an explanation of why CICS does this, see “Using early verification processing” on page 797.) RACF requires RACROUTE calls with the ACEE option to be issued in supervisor state. Therefore, if you use an ICHRTX00 exit that intercepts CICS RACROUTE calls, and replaces them with its own RACROUTE requests, your exit program should not assume that a REQUEST=VERIFY call was made in supervisor state.

When intercepting a REQUEST=VERIFY call, your exit program should check the settings of the two high-order bits of the byte at offset 3 in the RACINIT parameter list. If ENVIR=VERIFY was specified on the call (as in CICS early verification), these bits are both set on. If this is the case, your exit program should not issue any further RACROUTE macros. To do so could cause abends in RACF.

## The MVS router parameter list

The MVS router parameter list is generated when the RACROUTE macro is issued, and describes the security processing request by providing the request type. If the router exit routine exists, the router passes the parameter list to this exit. (If it does not exist, and if RACF is active, the router passes the parameter list to the RACF router.)

You can map the MVS router parameter list using the ICHSAFP macro. Its format is shown in the *OS/390 Security Server External Security Interface (RACROUTE) Macro Reference* manual.

## Router exit return codes

Your exit routine must return a return code in register 15. The hexadecimal values of the return code are shown in Table 44 on page 791.

Table 44. MVS router exit return codes

Code	Meaning
0	The exit has completed successfully. Control proceeds to the RACF front-end routine for further security processing and an invocation of RACF.
C8	The exit has completed successfully. The MVS router translates this return code to a router return code of '0' and returns control to the issuer of the RACROUTE macro (CICS), bypassing RACF processing. (See the next section.)
CC	The exit has completed successfully. The MVS router translates this return code to a router return code of '4' and returns control to CICS, bypassing RACF processing. (See the next section.)
D0	The exit has completed successfully. The MVS router translates this return code to a router return code of '8' and returns control to CICS, bypassing RACF processing. (See the next section.)
Other	If the exit routine sets any return code other than those described above, the MVS router returns control directly to CICS and passes the untranslated code as the router return code. Further RACF processing is bypassed.

### Passing control to a user-supplied ESM

Normally, a caller (such as CICS) invokes the MVS router and passes it request type, requester, and subsystem parameters via the RACROUTE exit parameter list. Using these parameters, the MVS router calls the router exit which, on completing its processing, passes a return code to the router. If the return code is '0', as defined above, the router invokes RACF. RACF reports the result of that invocation to the router by entering return and reason codes in register 15 and register 0 respectively. The router converts the RACF return and reason codes to router return and reason codes and passes them to the caller. The router provides additional information to the caller by placing the unconverted RACF return and reason codes in the first and second words of the router input parameter list.

If your installation does not use RACF, you can make the MVS router exit pass control to an alternative ESM. However, if you do so you must still provide CICS with the RACF return and reason codes that it expects to receive. You set the router exit return code, as defined in Table 44, so that RACF is not invoked; and you **simulate** the results of a RACF invocation by coding the exit so that it places the RACF return and reason codes in the first and second fullwords of the router input parameter list. RACF return and reason codes are documented in the *MVS Authorized Assembler Programming Reference* manual.

**Note:** Remember that it is possible for a subsystem other than CICS to call the MVS router by issuing a RACROUTE macro. (Application programs too, may issue RACROUTE macros directly.) Your router exit program can establish whether the caller is CICS by checking the “eyecatcher” fields (UXPARROW, UXPDFHXS, and UXPLKID) in the installation data parameter list—see “The installation data parameter list” on page 793.

---

## Using ESM exit programs to access CICS-related information

When CICS invokes the ESM, it passes information about the current CICS environment, for use by an ESM exit program, in an **installation data parameter list**. How your exit programs access the installation data parameter list depends on whether or not your ESM is RACF.

## For non-RACF users — the ESM parameter list

CICS (or another caller) passes information to your external security manager in the ESM parameter list, the address of which can be calculated using field SAFPRACP of the MVS router parameter list.

When the caller is CICS, the “INSTLN” field of the ESM parameter list points to the installation data parameter list, which contains CICS-related information that can be used by ESM exit programs.

The format of the ESM parameter list, and the actual name of the “INSTLN” field, vary, depending on which CICS security event is being processed. (The “request type” field (SAFPREQT) of the router parameter list shows why the ESM is being called by indicating the RACROUTE REQUEST type.) Table 45 shows how some formats of the ESM parameter list can be mapped using MVS macros.

Table 45. Mapping the ESM parameter list

RACROUTE REQUEST type	Parameter list mapping macro	INSTLN field name
VERIFY	IRRPRIPL	INITIPTR (X'10')
AUTH	ICHACHKL	ACHKIN31 (X'20')
FASTAUTH	Not available	Offset X'18'
LIST	Not available	Offset X'0C'
EXTRACT	Not available	None

**Note:** The INSTLN field points to the installation parameter list only if you specify INSTLN on the ESMEXITS system initialization parameter. The default value of this parameter is NOINSTLN, which means that no installation data is passed.

## For RACF users — the RACF user exit parameter list

If you are a RACF user, you can find the address of the installation data parameter list directly from the RACF user exit parameter list. The name of the relevant field in the user exit parameter list varies according to the RACROUTE REQUEST type and the RACF user exit that is invoked. The relationships between REQUEST type, exit name, and field name are shown in Table 46.

Table 46. Obtaining the address of the installation data parameter list

RACROUTE REQUEST type	RACF exit	Exit list mapping macro	Parameter list field name
VERIFY	ICHRIX01	ICHRIXP	RIXINSTL
VERIFY	ICHRIX02	ICHRIXP	RIXINSTL
AUTH	ICHRXC01	ICHRXCP	RCXINSTL
AUTH	ICHRXC02	ICHRXCP	RCXINSTL
FASTAUTH	ICHRFX01	ICHRFXP	RFXANSTL
FASTAUTH	ICHRFX02	ICHRFXP	RFXANSTL
LIST	ICHLX01	ICHLX1P	RLX1INST
LIST	ICHLX02	ICHLX2P	RLX2PRPA See note 2.

Table 46. Obtaining the address of the installation data parameter list (continued)

RACROUTE REQUEST type	RACF exit	Exit list mapping macro	Parameter list field name
EXTRACT	Not available	Not available	None

**Note:**

1. The “xxxINSTL” field points to the installation parameter list only if you specify INSTLN on the ESMEXITS system initialization parameter. The default value of this parameter is NOINSTLN, which means that no installation data is passed.
2. RLX2PRPA contains the address of the ICHRLX01 user exit parameter list (RLX1P). Field RLX1INST of RLX1P in turn points to the installation data parameter list.

For full descriptions of the RACF exit parameter lists, see the *OS/390 Security Server (RACF) Security Administrator's Guide* manual. For more information about CICS security processing using RACF, see Introduction to CICS security with RACF, in the *CICS RACF Security Guide*.

## The installation data parameter list

The installation data parameter list gives your ESM exit programs access to the following information:

- The CICS security event being processed.
- Details of the current CICS environment. That is:
  - The applid of the CICS region
  - The common work area (CWA)
  - The transaction being invoked
  - The program being executed
  - The CICS terminal identifier
  - The VTAM LU name
  - The terminal user area.

You can map the installation parameter list using the macro DFHXSUXP. The DSECT DFHXSUXP contains the following fields:

**UXPLEN**

A halfword containing the length of this parameter list in bytes.

**UXPARROW**

Arrow “eyecatcher” (>).

**UXPDFHXS**

The name of the owning component (DFHXS).

**UXPBLKID**

The name of the block identifier (UXPARMS).

**UXPPHASE**

Address of a 1-byte code that indicates the reason for the call to the ESM (that is, the security event being processed). The code can have one of the following values:

**DEFAULT\_SIGN\_ON (X'01')**  
Signon of default userid

**PRESET\_SIGN\_ON (X'02')**  
Signon of preset security terminal

**IRC\_SIGN\_ON (X'03')**  
Link signon for IRC (MRO) links

**LU61\_SIGN\_ON (X'04')**  
Link signon for LUTYPE6.1 links

**LU62\_SIGN\_ON (X'05')**  
Link signon for APPC links

**XRF\_SIGN\_ON (X'06')**  
XRF tracking of signon

**ATTACH\_SIGN\_ON (X'07')**  
Attach-time signon of link user

**NON\_TERMINAL\_SIGN\_ON (X'08')**  
Signon of a non-terminal userid

**USER\_SIGN\_ON (X'10')**  
Normal user signon

**PRESET\_SIGN\_OFF (X'22')**  
Sign-off when terminal deleted

**LINK\_SIGN\_OFF (X'25')**  
Sign-off when link is closed

**XRF\_SIGN\_OFF (X'26')**  
XRF tracking of sign-off

**ATTACH\_SIGN\_OFF (X'27')**  
End-of-task sign-off of link user

**NON\_TERMINAL\_SIGN\_OFF (X'28')**  
Sign-off of a non-terminal userid

**USER\_SIGN\_OFF (X'30')**  
Normal user sign-off

**TIMEOUT\_SIGN\_OFF (X'31')**  
Sign-off forced by the terminal abnormal condition program, or  
time-out by the CSSC transaction

**USRDELAY\_SIGN\_OFF (X'32')**  
Sign-off caused by expiry of USRDELAY interval

**DEFERRED\_SIGN\_OFF (X'33')**  
Sign-off deferred to task end

**USER\_ATTACH\_CHECK (X'40')**  
Transaction attach check for user

**LINK\_ATTACH\_CHECK (X'41')**  
Transaction attach check for link

**EDF\_ATTACH\_CHECK (X'42')**  
Transaction attach check for CEDF

**USER\_COMMAND\_CHECK (X'50')**  
Command checking for user



**LINK\_COMMAND\_CHECK (X'51')**  
Command checking for link

**EDF\_COMMAND\_CHECK (X'52')**  
Command checking for EDF

**USER\_RESOURCE\_CHECK (X'60')**  
Resource checking for user

**LINK\_RESOURCE\_CHECK (X'61')**  
Resource checking for link

**EDF\_RESOURCE\_CHECK (X'62')**  
Resource checking for EDF

**USER\_SURROGATE\_CHECK (X'68')**  
Surrogate checking for user

**LINK\_SURROGATE\_CHECK (X'69')**  
Surrogate checking for link

**EDF\_SURROGATE\_CHECK (X'6A')**  
Surrogate checking for EDF

**USER\_QUERY\_CHECK (X'70')**  
Query checking for user

**LINK\_QUERY\_CHECK (X'71')**  
Query checking for link

**EDF\_QUERY\_CHECK (X'72')**  
Query checking for EDF

**INITIALIZE\_SECURITY (X'80')**  
Initialization of CICS security

**REBUILD\_SECURITY (X'81')**  
CEMT or command-level SECURITY REBUILD

**XRF\_TRACK\_INITIALIZE (X'82')**  
XRF tracking of initial or rebuild.

**UXPSUBSY**

Address of an area containing the CICS subsystem identifier.

**UXPAPPL**

Address of an area containing the CICS application ID.

**Note:** When CICS is a member of a VTAM generic resource, the area pointed to by UXPAPPL contains the *generic*, not the specific, applid.

**UXPCWA**

Address of the Common Work Area.

**UXPTRAN**

Address of an area containing the transaction identifier.

**UXPPROG**

Address of an area containing the program name. The address may be zero if no program name can be identified.

**UXPTERM**

Address of an area containing the terminal identifier. The address may be zero if no terminal is associated with the request.

**UXPLUNAM**

Address of an area containing the VTAM LU name. The address may be zero if no terminal is associated with the request, or the area may be blank if the terminal is not a VTAM terminal.

**UXPTCTUA**

Address of the TCT user area.

**UXPTCTUL**

Address of a fullword containing the length of the TCTUA.

**UXPCOMM**

Address of a 2-word communication area.

---

## CICS security control points

The following list summarizes the RACROUTE macros used by CICS to invoke the ESM, and the control points at which they are issued.

**RACROUTE**

The “front end” to the macros described below, it invokes the MVS router. If RACF is not present on the system, RACROUTE can route to an alternative ESM, via the MVS router exit.

**RACROUTE REQUEST=VERIFY**

Issued at operator signon (with the parameter ENVIR=CREATE), and at sign-off (with the parameter ENVIR=DELETE). This macro creates or destroys an access control environment element (ACEE). It is issued at the following CICS control points:

- Normal signon through EXEC CICS SIGNON
- Signon of the default userid DFLTUSER
- Signon of preset security terminals
- Signon of MRO sessions
- Signon of LUTYPE6.1 sessions
- Signon of APPC sessions
- Signon for XRF tracking of the above
- Signon of the userid on attach requests (for all values of ATTACHSEC except LOCAL)
- Normal sign-off through EXEC CICS SIGNOFF
- Sign-off when deleting a terminal
- Sign-off when TIMEOUT expires
- Sign-off of MRO sessions
- Sign-off of LUTYPE6.1 sessions
- Sign-off of APPC sessions
- Sign-off for XRF tracking of the above
- Sign-off of the userid on attach requests (for all values of ATTACHSEC except LOCAL).

**RACROUTE REQUEST=VERIFYX**

This creates or deletes an ACEE in a single call. It is issued at the following CICS control points:

- Signon, as an alternative to VERIFY, when an optimized signon is performed for subsequent signons across an LU6.2 link with ATTACHSEC(VERIFY).

- When an invalid password, or a passticket is presented, or an EXEC CICS VERIFY PASSWORD command is issued.

#### **RACROUTE REQUEST=FASTAUTH**

Issued during resource checking, on behalf of a user who is identified by an ACEE. It is the high-performance form of REQUEST=AUTH, using in-storage resource profiles, and is issued at the following CICS control points:

- When attaching local transactions
- When checking link security for transaction attach
- Transaction validation for MRO tasks
- CICS resource checking
- Link security check for a CICS resource
- Transaction validation for EDF
- Transaction validation for the transaction being tested (by EDF)
- DBCTL PSB scheduling resource security check
- DBCTL PSB scheduling link security check
- Remote DL/I PSB scheduling resource check
- QUERY SECURITY with the RESTYPE option.

#### **RACROUTE REQUEST=AUTH**

This is a higher path length form of resource checking. It is used:

- After a call to FASTAUTH indicates an access failure that requires logging.
- When a QUERY SECURITY request with the RESCLASS option is used. This indicates a request for a resource for which CICS has not built in-storage profiles. (If CICS **has** in fact built in-storage profiles, REQUEST=AUTH uses them.)

#### **RACROUTE REQUEST=LIST**

Issued to create and delete the in-storage profile lists needed by REQUEST=FASTAUTH. (One REQUEST=LIST macro is required for each resource class.) It is issued at the following CICS control points:

- When CICS security is being initialized
- When an EXEC CICS REBUILD SECURITY is issued
- When XRF tracks either of these events.

#### **RACROUTE REQUEST=EXTRACT**

Issued (with the parameters SEGMENT=SESSION,CLASS=APPCLU) during verification of APPC BIND security, at the following CICS control point:

- BIND of APPC sessions.

It is also issued (with the parameters SEGMENT=CICS,CLASS=USER) during signon, at all the control points listed under RACROUTE REQUEST=VERIFY.

For a detailed description of these macros, see the *OS/390 Security Server External Security Interface (RACROUTE) Macro Reference* manual.

---

## **Using early verification processing**

The CICS signon routine invokes the SAF interface, using the RACROUTE REQUEST=VERIFY macro with the ENVIR=VERIFY option in problem-program state. Invoking this version of the macro has no effect if the ESM is RACF, but other external security manager products can get control through the SAF exit interface, and perform their own **early verification** routine.

CICS defers the creation of the accessor environment element until the RACROUTE REQUEST=VERIFY macro with the ENVIR=CREATE option is issued to perform the **normal verification** routine. The ENVIR=CREATE version of the macro is issued by the security manager domain running in supervisor state.

CICS passes the following information on the ENVIR=VERIFY version of the RACROUTE REQUEST=VERIFY macro:

**USERID**

The userid of the user signing on to the CICS region.

**GROUP**

The group name, if specified, of the group into which the user wants to sign on.

**PASSWRD**

The user's password to verify the userid.

**NEWPASS**

A new value, if specified, for the user's password. This changes the existing password and is to be used for subsequent signons.

**OIDCARD**

The contents, if supplied, of an operator identification card.

**APPL**

The APPLID of the CICS region on which the user is signing on. Which APPLID is passed depends on what is specified as system initialization parameters.

**INSTLN**

A pointer to a vector of CICS-related information, which you can map using the DFHXSUXP mapping macro. This pointer is valid only if ESMEXITS=INSTLN is specified as a system initialization parameter for the CICS region.

The installation data referenced by the INSTLN parameter includes a pointer, UXPCOMM, to a two-word communications area that can be used to pass information between the two phases of the signon verification process—between the early verification routine initiated by ENVIR=VERIFY, and the normal verification routine initiated by ENVIR=CREATE.

CICS maintains a separate communications area for each task, in CICS-key storage.

## Writing an early verification routine

An early verification routine, written for the ENVIR=VERIFY option, receives control from SAF in the usual way from the external security manager whose entry point is addressed by field SAFVRACR in the SAF vector table. It receives control in the same state as its caller, as follows:

- Problem-program state
- Task mode (usually the CICS quasi-reentrant TCB)
- PSW storage key 8
- 31-bit addressing mode
- Primary address translation mode.

Register 13 points to a standard 18-word save area. Register 1 points to a 2-word parameter list, where:

- The first word is the address of the SAF parameter list for the VERIFY function.
- The second word is the address of a 152-byte work area.

## Using CICS API commands in an early verification routine

An early verification routine can use CICS application programming interface (API) commands, provided it obeys the following interface rules:

- The routine must be written in assembler.
- Entry to the routine must be via the DFHEIENT macro, which saves the caller's registers and establishes a CICS early verification API environment.
- Exit from the routine must be via the DFHEIRET macro, which releases the CICS early verification API environment and restores the caller's registers.
- The routine *must* be link-edited with the special security domain API stub, DFHXSEAI, *instead of* the normal CICS API stub, DFHEAI0. The CICS early verification stub causes linkage to a special interface routine that is aware of the SAF interface linkage requirements, and saves the current CICS command environment. In addition, the standard EXEC interface stub DFHEAI should also be included, immediately before the early verification routine, with an ORDER statement:

```
INCLUDE SYSLIB(DFHXSEAI)
INCLUDE SYSLIB(DFHEAI)
ORDER  DFHEAI,verify-program,DFHEAI0
ENTRY  verify-program
```

The DFHEIENT and DFHEIRET macros are inserted by the CICS translator unless you specify

```
*ASM XOPTS(NOPROLOG,NOEPILOG)
```

as the first statement of the program. The DFHEIENT macro assumes that register 15 points to its first executable instruction.

Upon return from the DFHEIENT macro, a CICS storage area mapped by the DFHEISTG macro has been established. The pointer DFHEIBP (and the register specified in the EIBREG parameter of DFHEIENT) contains the address of an EXEC interface block (EIB). DFHEICAP contains the pointer to the original parameter list supplied by the SAF interface.

## Return and reason codes from the early verification routine

Before returning control, the early verification routine should set a return code and reason code in fields SAFPRRET and SAFPRREA of the SAF parameter list. It should also pass a value to be returned as the SAF return code in a register that is specified in the RCREG keyword of the DFHEIRET macro that is used to exit the program. These return codes are examined by the CICS signon function, and any non-zero value in SAFPRRET is interpreted as a verification failure and causes the signon to fail. A zero return code allows the signon to proceed, and eventually CICS issues a RACROUTE REQUEST=VERIFY,ENVIR=CREATE macro in supervisor state and under control of the CICS resource-owning TCB. It is only at this invocation that CICS accepts an ACEE address from the external security manager.



---

## Chapter 32. Writing a “good night” program

You can use the **GNTRAN** system initialization parameter to specify a “good night” transaction that you want CICS to invoke when a user’s terminal-timeout period expires.

The default value for **GNTRAN** is 'NO', which means that CICS does not schedule a “good night” transaction, but instead tries to sign off the terminal user. Whether or not the sign off is successful depends on the value of the **SIGNOFF** attribute on the terminal’s **TYPETERM** definition.

**Note:**

1. Any transaction that you specify on the **GNTRAN** parameter must be able to handle the type of communication area it is passed when terminal timeout occurs. The CICS sign-off transaction, **CESF**, can do this, but **CESN** and all other CICS-supplied transactions cannot.

For further information about **GNTRAN**, see the *CICS System Definition Guide*.

Writing your own “good night” program allows you to include functions in addition to, or instead of, sign-off. For example, your program could prompt the terminal user to enter their password, and allow the session to continue if the correct response is received. CICS supplies a sample “good night” program, **DFH0GNIT**, that demonstrates this, and a sample transaction definition, **GNIT**, that points to **DFH0GNIT**.

CICS passes the “good night” program a parameter list in the communications area shown in Figure 128 on page 802. If a terminal times out during a pseudoconversational transaction, your program could, using information in the parameter list:

- Ask for and check a response from the user
- Restore the screen left by the timed-out transaction
- Restore the cursor position
- Receive the communications area of the timed-out transaction, which is passed to the “good night” transaction as an input message
- Return with the **TRANSID** of the next transaction in the conversation.

---

### The communications area of the “good night” program

Figure 128 on page 802 shows the communications area passed to the “good night” program.

DFHSNGS				
DFHSNGS_FIXED	DS	0CL64		Fixed part of parameter list
GNTRAN_START_TRANSID	DS	CL4		TRANSID that invoked GNTRAN
GNTRAN_PSEUDO_CONV_FLAG	DS	CL1		Pseudoconversational flag
GNTRAN_SCREEN_TRUNCATED	DS	CL1		Screen buffer truncation flag
GNTRAN_TRANSLATE_TIOA	DS	CL1		Uppercase translation flag
	DS	CL9		Reserved
GNTRAN_TIMEOUT_TIME	DS	CL8		Time of terminal timeout
GNTRAN_TIMEOUT_REASON	DS	CL1		Reason for timeout
	DS	CL11		Reserved
GNTRAN_PSEUDO_CONV_TRANSID	DS	CL4		Next transaction ID
GNTRAN_SCREEN_LENGTH	DS	FL2		Length of screen buffer
GNTRAN_CURSOR_POSITION	DS	FL2		Cursor position
GNTRAN_SCREEN_WIDTH	DS	FL2		Width of screen
GNTRAN_SCREEN_HEIGHT	DS	FL2		Height of screen
GNTRAN_USER_FIELD	DS	CL16		Available to user program
DFHSNGS_VARIABLE	DS	0X		Variable part of parameter list
GNTRAN_SCREEN_BUFFER	DS	0X		Contents of screen buffer

Figure 128. Communications area passed to the “good night” program (assembler)

#### **GNTRAN\_START\_TRANSID**

The identifier of the transaction that started the “good night” transaction. If it was started by CICS because of a terminal timeout, GNTRAN\_START\_TRANSID is set to 'CEGN'. Your program should examine this field to check that timeout processing is appropriate (that is, that the “good night” transaction was started because of a terminal timeout and for no other reason).

#### **GNTRAN\_PSEUDO\_CONV\_FLAG**

A flag indicating whether the terminal timed out during a pseudoconversational transaction.

- Y** The terminal timed out between transactions that form part of a pseudoconversational application.
- N** The terminal did not time out between transactions that form part of a pseudoconversational application.

#### **GNTRAN\_SCREEN\_TRUNCATED**

A flag indicating whether the 3270 screen buffer had to be truncated.

- Y** The screen buffer was truncated.
- N** The screen buffer was not truncated.

#### **GNTRAN\_TRANSLATE\_TIOA**

An internal flag indicating whether DFHZSUP is to translate the TIOA to uppercase, if required by the TYPETERM or PROFILE setting:

- Y** The TIOA is to be translated.
- N** Uppercase translation is to be bypassed.

#### **GNTRAN\_TIMEOUT\_TIME**

The time that the terminal timed out, in CICS ABSTIME format.

#### **GNTRAN\_TIMEOUT\_REASON**

The reason for the timeout:

- T** No input from the terminal
- X** An XRF takeover.

#### **GNTRAN\_PSEUDO\_CONV\_TRANSID**

The identifier of the next transaction, if the terminal timed out during a



pseudoconversational sequence. (If the terminal did *not* time out during a pseudoconversational sequence, the value of this field is meaningless.)

**GNTRAN\_SCREEN\_LENGTH**

The length of the screen buffer.

**GNTRAN\_CURSOR\_POSITION**

The cursor position.

**GNTRAN\_SCREEN\_WIDTH**

The width of the screen in use when the terminal timed out.

**GNTRAN\_SCREEN\_HEIGHT**

The height of the screen in use when the terminal timed out.

You can use GNTRAN\_SCREEN\_WIDTH and GNTRAN\_SCREEN\_HEIGHT to decide whether to use the ERASE DEFAULT or ERASE ALTERNATE option when restoring the user's screen.

**GNTRAN\_USER\_FIELD**

This field is available for use by your "good night" user program. It is initialized to binary zeroes and is not changed by CICS. You can use it to help develop a pseudoconversational "good night" transaction.

**GNTRAN\_SCREEN\_BUFFER**

A variable length field containing the contents of the screen buffer.

---

## The sample "good night" program, DFH0GNIT

The sample "good night" program is a pseudoconversational COBOL program named DFH0GNIT. Copy books of the communications area passed to the "good night" program are supplied in assembler language, COBOL, PL/I, and C. The names of the supplied program, copy books, and mapset, and the CICSTS32.CICS libraries in which they can be found, are summarized in Table 47.

*Table 47. Sample "good night" program, copy books, and mapset*

Language	Member name	Library
Program source: COBOL only	DFH0GNIT	SDFHSAMP
Copy books: Assembler COBOL PL/I C	DFHSNGSD DFHSNGSO DFHSNGSL DFHSNGSH	SDFHMAC SDFHCOB SDFHPL1 SDFHC370
Mapset:	DFH\$GMAP	SDFHSAMP

## What the sample program does

The DFH0GNIT sample program:

1. Checks that it has been invoked for a terminal timeout, by testing the GNTRAN\_START\_TRANSID field of the communications area passed by CICS. If this contains anything other than 'CEGN', it quits.
2. If a flag within GNTRAN\_USER\_FIELD shows that this is the first invocation for this timeout:
  - a. If GNTRAN\_PSEUDO\_CONV\_FLAG indicates that the terminal timed out during a pseudoconversation, issues EXEC CICS RECEIVE to retrieve the communications area.
  - b. Saves the length of the communications area in another field within GNTRAN\_USER\_FIELD.

- c. Writes the communication area, if any, to a temporary storage queue.
  - d. Displays a screen asking the user to input his or her password, and sets the flag indicating that this has been done.
  - e. Issues EXEC CICS RETURN with TRANSID GNIT and the COMMAREA option, to continue the timeout process as a pseudoconversation.
3. If this is **not** the first invocation for this timeout:
    - a. Recovers the original communication area, if any, from the temporary storage queue.
    - b. Checks the password received from the user, and redisplay the timeout screen with an error message if it is incorrect.
  4. If the number of incorrect responses exceeds the maximum specified to your external security manager, DFH0GNIT returns immediately with TRANSID CESF, which tries to sign off the userid.
  5. If the correct password is entered, DFH0GNIT:
    - Restores the screen contents
    - Restores the cursor position.

If the terminal timed out during a pseudoconversational transaction, DFH0GNIT also:

    - Restores the communications area of the timed-out transaction
    - Returns with the TRANSID of the next transaction in the interrupted conversation.

---

## Customizing the sample “good night” program

You can write your “good night” program in any of the languages supported by CICS, with full access to the CICS application and system programming interfaces.

If you customize the supplied program, or write your own “good night” program, note the following:

- Like the sample, your program should be pseudoconversational, because it could be invoked simultaneously for many users (if, for example, many terminals time out during the lunch period). If your program is conversational, CICS maximum number of tasks (MXT) could quickly be reached.

When you are continuing your timeout program’s pseudoconversation, always specify the name of your “good night” transaction (for example, GNIT) as the next TRANSID. If you do not, CICS does not know that you are still handling the timeout, and results may be unpredictable.

- Your program should always start, like the sample program, by testing the GNTRAN\_START\_TRANSID field of the communications area passed by CICS. If it finds that the “good night” transaction was started for any reason other than a terminal timeout (for example, by an EXEC CICS START request), timeout processing may not be appropriate.
- To obtain the communications area of the timed-out transaction in a pseudoconversation, your program must issue an EXEC CICS RECEIVE command. (The communication area passed to it on invocation is **not** that of the timed-out transaction, but contains information about the timed-out transaction.)
- If your program tries to sign off the terminal user, the result depends on what is specified on the SIGNOFF option of the terminal’s TYPETERM definition:

**YES** The terminal is signed off, but not logged off.

**NO** The terminal remains logged on and signed on.

## **LOGOFF**

The terminal is both signed off and logged off.

- Specify the identifier (TRANSID) of your “good night” transaction on the GNTRAN system initialization parameter.

If you have customized the sample program, DFH0GNIT, specify the supplied sample transaction definition, GNIT.

If you have written your own “good night” program, named something other than DFH0GNIT, you must create and install a transaction definition that points to your program, and specify this definition on the GNTRAN SIT parameter.



---

## Part 8. Examining and modifying resource attributes

### **A general note about user-written programs:**

The following comment applies to all user-written programs mentioned in Part 8 of this book:

- Upon return from any customer-written program, CICS must always receive control in primary-space translation mode, with the original contents of all access registers restored, and with all general purpose registers restored (except for those which provide return codes or linkage information).

For information about translation modes, refer to the *IBM ESA/370 Principles of Operation* manual.

---

## Chapter 33. Using the programmable interface to CEDA

This chapter describes a programmable interface to the resource definition online (RDO) transaction, CEDA. The functions provided by RDO can be invoked from application programs, by a command such as:

```
EXEC CICS LINK PROGRAM('DFHEDAP')
          COMMAREA(CEDAPARM)
```

where DFHEDAP is the name of the entry point in the RDO program, and CEDAPARM is a user-defined name of a parameter list consisting of five 31-bit addresses (each contained in a fullword) as follows:

1. Address of a field containing the RDO command in source form.
2. Address of a halfword binary field specifying the length of the command. The maximum length of the input command is 1022 bytes.
3. Address of a 1-byte indicator field defined as follows:
  - X'80'** Display output at terminal instead of returning it to caller.
  - X'00'** Do not display output at terminal.
4. Address of a field in which output is to be placed by DFHEDAP.
5. Address of a halfword binary field specifying the maximum length of output that the application can handle.

If the indicator in address 3 is X'80', output is displayed at the terminal. In this case, you can enter any number of CEDA commands at the terminal, in response to the output displayed on your screen. Control is returned to your application program when you press PF3.

However, if the indicator is X'00' (output is not to be displayed at the terminal), DFHEDAP returns control to your application program immediately after processing the RDO command specified in the first address. At the same time, DFHEDAP returns the output as one or two concatenated, structured fields. The output from a single request comprises one field for the translation stage and one or none for the execution stage. Each field has the format:

- Binary halfword containing inclusive length of field.
- Binary halfword containing the number of messages produced.
- Binary halfword containing the highest message-severity: '0' and '4' continue to execution; '8' and '12' do not continue to execution.
- Variable-length data containing:
  - For the translation stage: diagnostic messages if there are any.
  - For the execution stage: data that would normally appear on the CEDA screen, including messages. Each line begins with a new line (NL) character and, otherwise, consists of blanks and uppercase alphanumeric characters.

The format of this data is not guaranteed from release to release, but it is the same as that displayed by CEDA. (Analysis of this data should not normally be necessary. Typically, your program is interested only in whether or not the command was successful.) If the total output is longer than the maximum length specified by the user, it is truncated.

### Note:

1. An attempt to start CEDA from an application program by an EXEC CICS START command must fail. This is because CEDA's first action is to

request input from its associated terminal, whereas an automatically initiated transaction must first send data to the terminal.

An attempt to start CEDA under CECI by an EXEC CICS START command fails for similar reasons.

2. The RDO command passed in address 1 of the CEDAPARM parameter list must be valid. (For example, spelling errors such as PRORGAM for PROGRAM are not corrected automatically when you use the programmable interface.)
3. You cannot use the programmable interface to change the values of CEDA keywords that are obsolete in this release of CICS, but which are retained for compatibility with earlier releases. That is, the interface does not support *compatibility mode*.
4. CEDA issues various syncpoints as part of its processing. Therefore, when your program links to DFHEDAP the current unit of work (UOW) of the transaction is completed. This may result in problems if, for example, there are outstanding browse operations against VSAM datasets.

---

## When to use the programmable interface

Remember that you can use the offline utility program, DFHCSDUP, to examine and amend CSD files; and that DFHCSDUP can be invoked from a user program, running either in batch mode or under TSO. (See Chapter 34, “User programs for the system definition utility program (DFHCSDUP),” on page 813.)

**Using DFHCSDUP is the recommended method for updating CSD files in bulk.**

You should only use the interface described in this chapter where the required function includes the INSTALL command, which is not available from DFHCSDUP.

---

## Using DFHEDAP in a DTP environment

The LINK DFHEDAP function is intended to be used in a single environment. It is not supported within a distributed transaction programming (DTP) environment—using it such an environment can result in abends.

In a DTP environment, CICS may attempt to propagate SYNCPOINT and SYNCPOINT ROLLBACK requests across sessions to other systems. These requests are issued by CEDA modules that are invoked by the use of LINK DFHEDAP. Note that the issuing of SYNCPOINT ROLLBACK means that LINK DFHEDAP cannot be used in a DTP environment that owns LU6.1 links.

Generally, a session should be in SEND state to initiate a SYNCPOINT, but the session may not remain in SEND state once a LINK DFHEDAP command is issued. (For information about valid commands and states, see the *CICS Distributed Transaction Programming Guide*. This book also explains the APPC architecture rules on a session's state after SYNCPOINT and SYNCPOINT ROLLBACK requests are made.)

The code invoked by LINK DFHEDAP can result in wrong sequence of commands. For example, if the code invoked by DFHEDAP issues a SYNCPOINT ROLLBACK from a back-end application program whose session is in SEND state (and which has never issued a SYNCPOINT), the session will be put into RECEIVE state. If the code invoked by DFHEDAP then issues a SYNCPOINT, an abend occurs. This can



be prevented by all DTP applications issuing a SYNCPOINT request when they get into SEND state (on all of their sessions) and before they issue the LINK DFHEDAP command.

Do not attempt to use LINK DFHEDAP when more than a pair of DTP application programs are involved—that is, one front end and one back end.

The general rules for using LINK DFHEDAP within a simple DTP environment (one front end and one back end) are that all sessions in a DTP environment should be in SEND state when the LINK DFHEDAP command is issued, and they should revert to SEND state in the event of a SYNCPOINT ROLLBACK being issued by the DFHEDAP code.



---

## Chapter 34. User programs for the system definition utility program (DFHCSDUP)

This chapter tells you how to write programs for use with the CICS system definition utility program (DFHCSDUP). It is divided into the following sections:

1. “An overview of DFHCSDUP” contains background information.
2. “Invoking a user program from DFHCSDUP” on page 814 describes the DFHCSDUP EXTRACT command, and tells you how to write a user program to be invoked from DFHCSDUP.
3. “Invoking DFHCSDUP from a user program” on page 821 tells you how to write a program from which DFHCSDUP itself can be invoked.
4. “The user exit points in DFHCSDUP” on page 824 describes the user exit points in DFHCSDUP.
5. “The sample program, DFH\$CUS1” on page 829 describes a sample program that shows you how to invoke DFHCSDUP from a user program.

---

### An overview of DFHCSDUP

The CICS system definition utility program (DFHCSDUP) is a component of resource definition online (RDO). DFHCSDUP is an offline utility program that allows you to read from and write to a CICS system definition (CSD) file, either while CICS is running or while it is inactive.

Using DFHCSDUP, you can do the following:

- Add a group to the end of a named list in a CSD file
- Alter the definition of a single resource, on the CSD
- Append a group list from one CSD file to a group list in another, or in the same, CSD file
- Copy all of the resource definitions in one group to another group in the same, or in a different, CSD file
- Define a single resource, or a group of resources, on the CSD
- Delete from the CSD a single resource definition, all of the resource definitions in a group, or all of the group names in a list
- Extract requested data from the CSD and pass it to a named user program for processing
- Initialize a new CSD file, and add to it the CICS-supplied resource definitions
- List selected resource definitions, groups, and lists
- Migrate the contents of a table from a CICS load library to a CSD file
- Process an APAR—that is, apply maintenance for a specific APAR to the CSD
- Remove a single group from a list on the CSD file
- Scan all IBM-supplied and user-defined groups for a resource
- Service a CSD file when necessary
- Upgrade the CICS-supplied resource definitions in a primary CSD file for a new release of CICS
- Define resources using a set of user-defined default values (USERDEFINE command)
- Verify a CSD file by removing internal locks on groups and lists.

You can invoke DFHCSDUP in two ways:

- As a batch program. The next section refers to this method.
- From a user program running either in batch mode or in a TSO environment. “Invoking DFHCSDUP from a user program” on page 821 describes this method.

---

## Invoking a user program from DFHCSDUP

This section refers to DFHCSDUP as a batch program. It describes the DFHCSDUP EXTRACT command, and the three sample programs that can be invoked during EXTRACT processing.

## Writing a program to be invoked during EXTRACT processing

The DFHCSDUP LIST command produces reports about the current status of the CSD file that vary only according to the input parameters you provide. Another DFHCSDUP command, EXTRACT, causes the CSD data you select to be passed unformatted to a user program. The user program can then create reports of the CSD data that meet local requirements. For example, you could cross-refer related definitions (such as TERMINALS and TYPETERMs), or you could sort the data by attribute values, such as security keys or processing priorities. The user program could also write the requested resource attributes to a data set to be used as input to a database product, such as SQL, DB2, or the Data Extract program product.

The user program must be linked RMODE(24). It receives control in 24-bit primary-space translation mode. (For information about translation modes, see the *IBM ESA/370 Principles of Operation* manual.) The contents of the access registers are unpredictable. The program must return control in 24-bit primary-space translation mode, and it must restore any access registers that it modifies (in addition to restoring the general purpose registers).

There are three sample programs that can be invoked from DFHCSDUP during EXTRACT processing. The sample programs, and how to replace them with your own versions, are described on page “The sample EXTRACT programs” on page 816.

## The EXTRACT command

The EXTRACT command takes requested data from the CSD and passes it to a user program for processing. The command has the following format:

```
EXTRACT {GROUP(name)|LIST(name)} USERPROGRAM(name) [OBJECTS]
```

### GROUP

selects only those resource definitions within the named group. You can specify a generic group name, as on the DFHCSDUP LIST command.

### LIST

selects only those resource definitions within the groups contained in the named list. You can specify a generic list name only if you do not specify the OBJECTS option.

### OBJECTS

returns the detail of each resource definition. You can extract resource definition data at two levels of detail:

1. If you omit the OBJECTS option, the command extracts one of the following:
  - The names of all the resource definitions within the specified group
  - The names of all the groups within the specified list.

2. If you specify the OBJECTS option, all the attributes of the resource definitions are also extracted.

#### **USERPROGRAM**

is the name of the user-written program that is to process the data retrieved by the EXTRACT command. You must supply a USERPROGRAM value.

## **When the user program is invoked**

The user program can be invoked at nine different points during the processing of the EXTRACT command by DFHCSDUP. However, your program is invoked at all of these points only if you specify both LIST and OBJECTS on the EXTRACT command. The invocation points are as follows:

1. At the beginning of EXTRACT processing. This is to allow for activities such as file opening and storage acquisition.
2. At the beginning of LIST processing, but only if you have specified a LIST value on the EXTRACT command.
3. At the start of every group being processed by the EXTRACT command.
4. At the start of each object (that is, resource type—TERMINAL, PROGRAM, and so on) that is being processed, to allow for selection on an object or group basis.

**Note:** If you have specified LIST but not OBJECTS on the EXTRACT command, this invocation does not occur.

5. For every keyword (attribute) in the extracted object, but only if you have specified OBJECTS on the EXTRACT command. This is to allow for the detailed processing that may be necessary for cross-referencing.
6. At the end of every object—that is, when all of the keywords within an object have been processed. This is to allow for the processing of data built up from the detailed items, and it occurs once for each object.
7. At the end of every group, to allow for processing of the accumulated data.
8. At the end of LIST processing, if you have specified a LIST value on the EXTRACT command.
9. When EXTRACT processing is complete, to allow for closing of files, release of storage, and so on.

## **Parameters passed from DFHCSDUP to the user program**

On every invocation of the user program, DFHCSDUP passes a parameter list addressed by general register 1. The parameter list consists of a series of fullwords that address the fields described in more detail below. The addresses set in the parameter list vary, depending on the point that EXTRACT processing has reached.

The parameter list contains the following fields:

#### **Function Type Ptr**

The address of a halfword field that contains a code defining the point in EXTRACT processing reached.

The function codes are as follows:

- |   |                   |
|---|-------------------|
| 0 | Initial call      |
| 2 | List start call   |
| 4 | Group start call  |
| 6 | Object start call |

- 8 Keyword detail call
- 10 Object end call
- 12 Group end call
- 14 List end call
- 16 Final call.

**Workarea Ptr**

This is the address of a field containing the address of a fullword to be used by the user application to store the address of any user-acquired work area.

**Back translated command Ptr**

The address of a fullword that contains the address of a 75-byte area of storage that contains the EXTRACT command that is being processed.

**List name Ptr**

The address of an 8-byte field that identifies the RDO list from which the current object is taken. This value is set only on the 'list start' and 'list end' calls.

**Group name Ptr**

The address of an 8-byte field that identifies the RDO group from which the current object is taken. This value is set on the 'group start', 'group end', 'object start', 'object end', and 'keyword' calls.

**Object type Ptr**

The address of a 12-byte field that identifies the type of object (such as TRANSACTION, PROGRAM, and so on), and is set only on the 'object start', 'object end', and 'keyword' calls.

**Object name Ptr**

The address of an 8-byte field that contains the name of the object, and is set only on the 'object start', 'object end', and 'keyword' calls.

**Keyword name Ptr**

The address of a 12-byte field that contains the name of the keyword being processed, and is set only on 'keyword' calls.

**Keyword length Ptr**

The address of a halfword field that contains the length of the value associated with the keyword, and is set only on 'keyword' calls.

**Keyword Value Ptr**

The address of the storage area that contains the value associated with the keyword, and is set only on 'keyword' calls.

**Note:** Fields not set with a pointer value contain a null value.

## The sample EXTRACT programs

There are three CICS-supplied sample programs that can be invoked during DFHCSDUP EXTRACT processing. Two of these are provided in COBOL, PL/I, and assembler language, and the third is provided in COBOL only. They are outlined in Table 48.

*Table 48. Sample EXTRACT user programs for the DFHCSDUP utility program*

Program names	Languages	Description
DFH\$CRFA DFH0CRFC DFH\$CRFP	Assembler COBOL PL/I	Produces a cross-reference listing of the resource definitions defined in the group or list you specify on the EXTRACT command.

Table 48. Sample EXTRACT user programs for the DFHCSDUP utility program (continued)

Program names	Languages	Description
DFH\$FORA DFH0FORC DFH\$FORP	Assembler COBOL PL/I	Formats the group or list of resource definitions you specify on the EXTRACT command into a form suitable for the DB2 table load utility.
DFH0CBDC	COBOL	Writes the list or group of resource definitions you specify on the EXTRACT command in the form of DEFINE commands, suitable for use as a backup copy of the resources extracted.

You can use the sample programs as supplied, or as models on which to base your own programs.

The assembler-language and COBOL versions of the CSD cross-referencing program, DFH\$CRFA and DFH0CRFC respectively, are supplied in executable form in CICS32.CICS.SDFHLOAD. The PL/I version, DFH\$CRFP, is supplied in source form only.

The assembler-language and COBOL versions of the DB2 formatting program, DFH\$FORA and DFH0FORC respectively, are supplied in executable form in CICS32.CICS.SDFHLOAD. The PL/I version, DFH\$FORP, is supplied in source form only.

The CSD backup utility program, DFH0CBDC, is supplied in executable form in CICS32.CICS.SDFHLOAD.

The source statements of all versions of all the sample programs are supplied in CICS32.CICS.SDFHSAMP.

The CICS-supplied sample DB2 formatting programs (DFH\$FORx) cannot be used when the CSD compatibility option (COMPAT) is specified on the DFHCSDUP utility program. The output from the CSD cross-reference listing and CSD backup utility programs depends on whether the compatibility option is specified. If the compatibility option is specified, the output includes obsolete keywords from releases before CICS Transaction Server for z/OS, Version 3 Release 2; if the option is not specified, only keywords from CICS Transaction Server for z/OS, Version 3 Release 2 are output.

Note that the sample programs require you to specify the OBJECTS keyword on the DFHCSDUP EXTRACT command.

The output data definition names (ddnames) for the sample programs are as follows:

**CRFOUT**

CSD cross-referencing program

**FOROUT**

DB2 formatting program

**CBDOUT**

CSD backup utility program.

The sample programs are discussed in the next three sections.

## The CSD cross-referencing program

The CICS-supplied sample CSD cross-referencing program produces a cross-reference listing of objects and keywords on the CSD. The data gathered by the EXTRACT command is passed to the sample program, where it is saved in a cross-reference table. On the final call to this sample program, the contents of the table are printed in collating sequence.

The program must be run against an EXTRACT command of the form:

```
EXTRACT GROUP(group name) OBJECTS USERPROGRAM(program-name)
```

or:

```
EXTRACT LIST(list name) OBJECTS USERPROGRAM(program-name)
```

Note that the sample program requires you to specify the OBJECTS keyword.

For this program only, in addition to the EXTRACT command, you must define, in a sequential data set, the objects and keywords for which you want a cross-reference listing. The data set is read by the sample program using the ddname CRFINPT.

CRFINPT is a sequential file containing 80-byte records. Each record contains one object or keyword to be cross-referenced. You can cross-reference any valid resource type or attribute known to CEDA. For example, your CRFINPT file may contain the following entries (one per line):

```
PROGRAM  
TRANSACTION  
TYPETERM  
DSNAME
```

For each record in the file, a report is produced detailing the different values assigned to the keyword, where they are defined, and where they are used. Note that keyword values longer than 44 characters are truncated.

You should define the DCB subparameters for CRFINPT as DSORG=PS, RECFM=F, LRECL=80, and BLKSIZE=80.

## The DB2 formatting program

The CICS-supplied sample DB2 formatting program organizes the CSD data passed to it from DFHCSDUP into a format suitable for the DB2 table load utility. The data is organized into columns that correspond to the columns defined in the load utility's input. Each selected resource causes a record to be written to this program's output file, with the first 4 characters identifying the resource type.

The program must be run against an EXTRACT command of the form:

```
EXTRACT GROUP(group name) OBJECTS USERPROGRAM(program-name)
```

or:

```
EXTRACT LIST(list name) OBJECTS USERPROGRAM(program-name)
```

Note that the sample program requires you to specify the OBJECTS keyword.

## The CSD backup utility program

The CICS-supplied sample CSD backup utility program produces a file of DFHCSDUP DEFINE control statements. The file can be used:

- For later editing and commenting to document CSD resources



- For distribution, in part or as a whole, to other CICS installations
- To recreate or add resource definitions to any CSD using DFHCSDUP.

The program must be run against an EXTRACT command of the form:

```
EXTRACT GROUP(group name) OBJECTS USERPROGRAM(program-name)
```

or:

```
EXTRACT LIST(list name) OBJECTS USERPROGRAM(program-name)
```

Note that the sample program requires you to specify the OBJECTS keyword.

Note the following points when using DFH0CBDC:

- It can deal with only one set of data during each invocation of DFHCSDUP; if two EXTRACT commands are issued, the second set of data overwrites the first.
- In the file produced by DFH0CBDC, any DEFINE statements that relate to CICS-supplied resources are preceded by an asterisk (\*) in column 1; in other words, they are commented out. This is important if you use the file as input to define resources to a CSD. (The CICS-supplied definitions are already present in the CSD, having been produced automatically when it was initialized.)
- If you remove an asterisk from column 1 (to reinstate the DEFINE statement), do so by deleting it, **not** by overtyping it with a blank. This ensures that the resulting command is no more than 72 characters long; if it is longer than this, errors occur when the output is passed back through DFHCSDUP.

## Assembling and link-editing EXTRACT programs

You must assemble (or compile) and link-edit DFHCSDUP user programs as batch programs, not as CICS applications, and you need link-edit control statements appropriate to the language in which they are written.

**Note:** DFHCSDUP user programs should not be translated, or unpredictable results could occur.

When you compile the COBOL versions of the sample programs, you must specify the compiler attributes RENT and NORES.<sup>8</sup>

When you link-edit the programs, you must specify the following link-edit control statements:

- An ENTRY statement that defines the entry name as DFHEXTRA
- An INCLUDE statement for a CICS-supplied stub that must be included in your user program
- A CHANGE statement to change the dummy CSECT name in the CICS-supplied stub from EXITEP to the name of your user program.

When you link-edit the COBOL versions of the sample programs, you must specify RMODE(24).

These requirements are explained in more detail for each of the languages (assembler, COBOL, and PL/I ) shown in the following sample job streams.

---

8. The RENT compiler attribute prevents an abend C03 ('Dataset was not closed properly') occurring after the sample program receives an abend such as B37 ('Dataset size is smaller than output').

## An assembler-language version

The sample job in Figure 129 shows the link-edit statements you need for an assembler-language version of a DFHCSDUP user program.

```
//DFHCRFA JOB (accounting information),CLASS=A,MSGCLASS=A,NOTIFY=userid
/* .
/* Assembler job step here
/* .
//LINK EXEC PGM=IEWL,PARM='XREF,LIST,LET'
//OBJLIB DD DSN=object.module.library,DISP=SHR
//SYSLIB DD DSN=CICSTS32.CICS.SDFHLOAD,DISP=SHR
//SYSLMOD DD DSN=user.library,DISP=SHR
//SYSUT1 DD UNIT=SYSDA,SPACE=(1024,(100,10))
//SYSPRINT DD SYSOUT=A
//SYSLIN DD *
ENTRY DFHEXTRA 1
CHANGE EXITEP(csectname) 2
INCLUDE SYSLIB(DFHEXAI) 3
INCLUDE OBJLIB(obj-name) 4
NAME progname(R) 5
```

Figure 129. Link-edit control statements for a DFHCSDUP user program (assembler-language)

### Notes for the assembler job:

1 Specify the entry name as DFHEXTRA, which is the entry name in the CICS-supplied stub, DFHEXAI. (See 3.)

2 The CICS-supplied stub, DFHEXAI, is generated with a link to the user program using a dummy CSECT name (EXITEP). Use the link-edit CHANGE statement to change the CSECT name from EXITEP to the name of the CSECT in the user program. In the two CICS-supplied assembler-language sample programs, these names are:

#### CREFCSD

The CSECT name in DFH\$CRFA, the cross-reference listing user program.

#### FORMCSD

The CSECT name in DFH\$FORA, the DB2-formatting user program.

3 Include DFHEXAI in any assembler-language user program that you write for use with the DFHCSDUP EXTRACT command. DFHEXAI is the interface stub between DFHCULIS, a module in DFHCSDUP, and the user program.

4 obj-name is the name of the library member that contains the assembled object module.

5 progname is the name you want to call the load module; this is the name that you specify on the USERPROGRAM parameter of the EXTRACT command.

## A Language Environment version

The sample job in Figure 130 on page 821 shows the link-edit statements you need for a DFHCSDUP user program written in a Language Environment-conforming high-level language.

```

//DFHCRFA JOB (accounting information),CLASS=A,MSGCLASS=A,NOTIFY=userid
//* .
//* Compile job step here
//* .
//LINK EXEC PGM=IEWL,PARM='XREF,LIST,LET'
//SYSLIB DD DSN=PP.ADLE370.OS39025.SCEELKED
//CICSLIB DD DSN=CICSTS32.CICS.CICS.SDFHLOAD,DISP=SHR
//OBJLIB DD DSN=object.module.library,DISP=SHR
//SYSLMOD DD DSN=user.library,DISP=SHR
//SYSUT1 DD UNIT=SYSDA,SPACE=(1024,(100,10))
//SYSPRINT DD SYSOUT=A
//SYSLIN DD *
ENTRY DFHEXTRA 1
CHANGE EXITEP(prof-id) 2
INCLUDE CICSLIB(DFHEXLE) 3
INCLUDE OBJLIB(obj-prog) 4
NAME progname(R) 5

```

Figure 130. Link-edit control statements for a DFHCSDUP user program (Language Environment)

### Notes for the Language Environment job:

1 Specify the entry name as DFHEXTRA, which is the entry name in the CICS-supplied stub, DFHEXLE (see 3).

2 The CICS-supplied stub, DFHEXLE, is generated with a link to the user program using a dummy CSECT name (EXITEP). Use the link-edit CHANGE statement to change the CSECT name from EXITEP to the name specified on the PROC statement in the user program.

3 Include DFHEXLE in any LE-conforming user program that you write for use with the DFHCSDUP EXTRACT command. DFHEXLE is the interface stub between DFHCULIS, a module in DFHCSDUP, and the Language Environment user program.

4 obj-prog is the name of the object program.

5 progname is the name you want for the load module; this is the name that you specify on the USERPROGRAM parameter of the EXTRACT command.

---

## Invoking DFHCSDUP from a user program

It is possible to invoke DFHCSDUP from a user program. This method enables you to create a flexible interface to the utility. By specifying the appropriate entry parameters, your program can cause DFHCSDUP to pass control to an exit routine at any of five exit points. The exits can be used, for example, to pass commands to DFHCSDUP, or to respond to messages produced by DFHCSDUP processing.

You can run your user program:

- In batch mode
- Under TSO.

### Note:

1. In a TSO environment, it is normally possible for the terminal operator to interrupt processing at any time by means of an ATTENTION interrupt. In order to protect the integrity of the CSD file, DFHCSDUP does not respond to such an interrupt until after it has completed the processing associated with the current command. It then writes

message number 'DFH5618' to the put-message exit (see "The put-message exit" on page 827), where this is available, and also to the default output file:

```
AN ATTENTION INTERRUPT WAS  
REQUESTED DURING DFHCSDUP PROCESSING
```

Your put-message exit routine can terminate DFHCSDUP, if desired. (Note that you **must** supply a put-message routine if you want your operators to regain control after an ATTENTION interrupt.)

2. Suitably authorized TSO operators can use the CEDA INSTALL transaction to install resources that have previously been defined with DFHCSDUP.

## Entry parameters for DFHCSDUP

When invoking DFHCSDUP, your program passes a parameter list addressed by register 1. It may pass up to five parameters, as described below:

### OPTIONS

A list of character strings, separated by commas. (The information passed here is that which would otherwise be passed on the PARM keyword of the EXEC statement of JCL.) A maximum of four options can be specified:

#### **CSD({READWRITE|READONLY})**

specifies whether you require read-write or read-only access to the CSD.

#### **PAGESIZE(nnnn)**

specifies the number of lines per page on output listings. Valid values for nnnn are 4 through 9999. The default value is 60.

#### **NOCOMPAT|COMPAT**

specifies whether DFHCSDUP is to be invoked in compatibility mode. By default, it is invoked in noncompatibility mode. For details of compatibility mode, see the *CICS Resource Definition Guide*.

#### **UPPERCASE**

specifies that output listings are to be printed entirely in uppercase characters. The default is to print in mixed case.

### DDNAMES

A list of ddnames that, if specified, are substituted for those normally used by DFHCSDUP.

### HDING

The starting page number of any listing produced by DFHCSDUP. You can use this parameter to ensure that subsequent invocations produce logically numbered listings. If this parameter is not specified, the starting page number is set to 1.

The length of the page number data (field 'bb' in Figure 131 on page 823) must be 0 or 4. The page number, if supplied, must be four numeric EBCDIC characters. The field, if present, is updated upon exit from DFHCSDUP with a number one greater than that of the last page printed.

### DCBS

The addresses of a set of data control blocks for use internally by DFHCSDUP. Any DCBs (or ACBs) that you specify are used internally, instead of those normally used by DFHCSDUP.

Note that if you specify both replacement ddnames and replacement DCBs, the alternative DCBs are used, but the alternative ddnames are disregarded.

**EXITS**

The addresses of a set of user exit routines to be invoked during processing of DFHCSDUP.

The structure of the parameter list is shown in Figure 131.

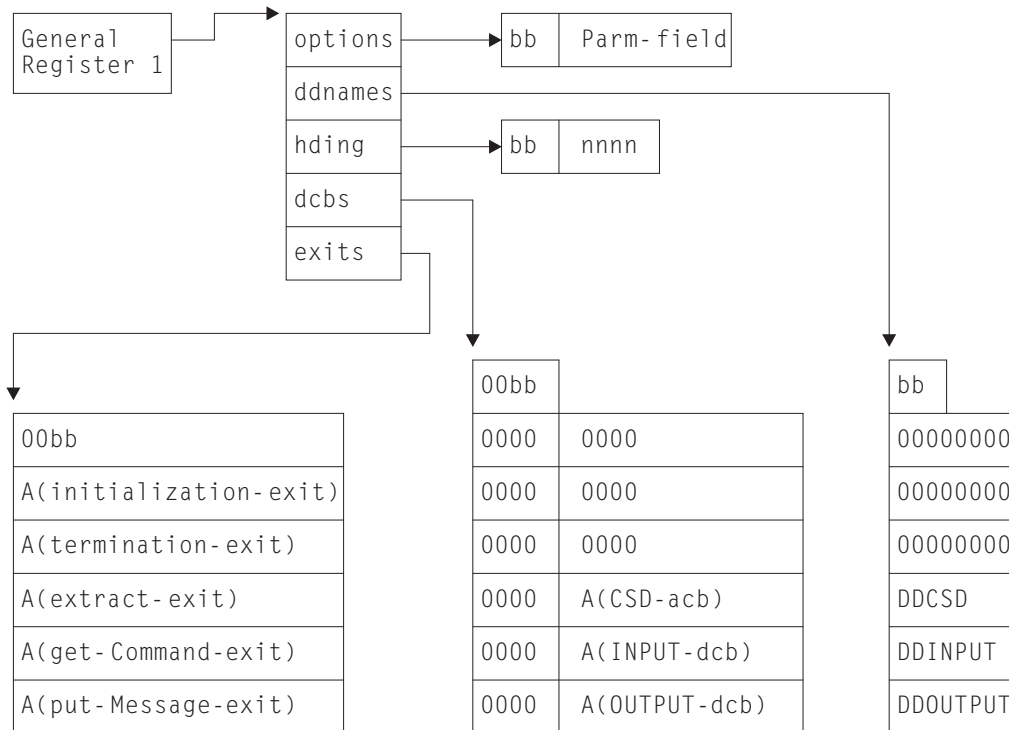

bb is a two-byte field containing the length of the functional data  
 00 represents two bytes of binary zeros  
 A() means "address of"

Figure 131. Entry parameters for DFHCSDUP

You should note the following:

- Each parameter contains a length field, followed by some functional data.
- The functional data for the DDNAMES, DCBS, and EXITS parameters contains multiple subentries.
- The parameters OPTIONS, DDNAMES, and HDING are aligned on a halfword boundary, and the first two bytes 'bb' contain the binary number of **bytes** in the following functional data.
- The parameters DCBS and EXITS are aligned on a fullword boundary, and the first four bytes '00bb' contain the binary number of **fullwords** in the following functional data.
- If the 'bb' field for any parameter is zero, the parameter is ignored.
- If a subentry in the functional data is all binary zeros, it is ignored.
- If any subentry is not within the length indicated by 'bb', it is ignored.
- In the DDNAMES functional data, each subentry consists of an 8-byte ddname to replace a default ddname used by DFHCSDUP. DFHCSDUP does not use the

first three subentries of the DDNAMES parameter. The fourth, fifth, and sixth subentries, if present, replace the ddnames of DFHCSD, SYSIN, and SYSPRINT, respectively.

- In the DCBS functional data, each subentry consists of two fullwords. The first word is not used by CICS. The second word contains the address of an open DCB or ACB. You must ensure that the DCB or ACB has been opened with the correct attributes, which are:

**PRIMARY CSD**

AM=VSAM,MACRF=(KEY,DIR,SEQ,IN,OUT)

**INPUT FILE**

DSORG=PS,MACRF=GL,LRECL=80,RECFM=FB

The address of any end-of-data routine (EODAD) or I/O error routine (SYNAD) in the DCB is overlaid by DFHCSDUP.

**OUTPUT FILE**

DSORG=PS,MACRF=PL,LRECL=125,RECFM=VBA

DFHCSDUP does not use the first three subentries of the DCBS parameter. The fourth, fifth, and sixth subentries, if present, are used instead of the internal DCBs or ACBs for DFHCSD, SYSIN, and SYSPRINT, respectively.

- In the EXITS parameter, each subentry consists of a single fullword containing the address of an exit routine. You must specify the exit routines in the order shown in Figure 131 on page 823. (The user exits are described in “The user exit points in DFHCSDUP.”)

## Responsibilities of the user program

Before invoking DFHCSDUP, your calling program must ensure that:

- RMODE(24) is in force.
- System/370 register conventions are obeyed.
- If the EXITS parameter is passed, any programming environment needed by the exit routines has been initialized.
- Any ACBs or DCBs passed for use by DFHCSDUP are OPEN.

---

## The user exit points in DFHCSDUP

There are five user exit points in DFHCSDUP. By specifying the appropriate entry parameters, you can cause DFHCSDUP to pass control to an exit routine at any of these points.

None of the user exits supports XPI calls.

## Parameters passed to the user exit routines

The address of a parameter list is passed to the user exit routine in register 1. The list contains some standard parameters that are passed to all of the exit routines, and may also contain some exit-specific parameters that are unique to the exit point from which the exit routine is being invoked.

The standard parameter list is different from that used by CICS global user exits. The following DFHUEXIT DSECT maps the standard parameter list used by DFHCSDUP and the sample program DFH\$CUS1. (The UEPCMDA and UEPCMDL fields are used only by the get-command exit.)

DFHUEXIT	DSECT		
UEPEXN	DS	A	ADDRESS OF EXIT NUMBER
UEPGAA	DS	A	ADDRESS OF GLOBAL AREA
UEPGAL	DS	A	ADDRESS OF GLOBAL AREA LENGTH
UEPCRCA	DS	A	ADDRESS OF CURRENT RETURN-CODE
UEPTCA	DS	A	ADDRESS OF TCA
UEPCSA	DS	A	ADDRESS OF CSA
UEPHMSA	DS	A	ADDRESS OF SAVE AREA USED BY HOST
UEPSTACK	DS	A	ADDRESS OF KERNEL STACK ENTRY
UEPXSTOR	DS	A	ADDRESS OF STORAGE OF XPI PARMS
UEPTRACE	DS	A	ADDRESS OF TRACE FLAG
*			
UEPCMDA	DS	A	ADDRESS OF UTILITY COMMAND
UEPCMDL	DS	A	ADDRESS OF LENGTH OF UTILITY
*			COMMAND

Explanations of the exit-specific parameters are included in the descriptions of the individual exits, which follow.

## The initialization exit

The initialization exit is invoked once during DFHCSDUP initialization. Its purpose is to allow a routine to perform exit-related initialization. For example, the routine may obtain its own global work area and save its address in UEPGAA and its length in the halfword pointed to by UEPGAL. These values are retained by DFHCSDUP and become available at the other exit points.

### When invoked

Invoked once, on entry to DFHCSDUP.

### Exit-specific parameters

None.

### Return codes

#### UERCNORM (X'00')

Continue processing.

#### UERCERR

Irrecoverable error. This causes DFHCSDUP to terminate with a return code of '8'.

### XPI calls

Must not be used.

## The get-command exit

The purpose of the get-command exit is to read in command lines. If it is specified, no commands are read from SYSIN.

On invocation, your exit routine must supply the address and length of a **complete** command. It must return control with either the normal return code 'UERCNORM' or with the code 'UERCDONE', signifying that it has no more commands to pass. After it has processed each command, DFHCSDUP reinvokes the exit until return code 'UERCDONE' is received.

### When invoked

Invoked multiple times, at the point where DFHCSDUP would otherwise read commands from SYSIN.

### Exit-specific parameters

**UEPCMDA**

Pointer to the address of a command.

**UEPCMDL**

Address of a halfword containing the length of the command text.  
The maximum length that can be specified is 1536 bytes.

**Return codes****UERCNORM (X'00')**

Continue processing.

**UERCDONE (X'04')**

No more commands to process. (This is equivalent to reaching end-of-file on the SYSIN file.)

**UERCERR**

Irrecoverable error. This causes DFHCSDUP to terminate with a return code of '8'.

**XPI calls**

Must not be used.

## The extract exit

The extract exit is invoked at various points during processing of the EXTRACT command. The points are listed in "When the user program is invoked" on page 815.

**Note:**

1. If you do not specify an EXTRACT user exit routine on the entry linkage to DFHCSDUP, or on the USERPROGRAM keyword, a syntax error occurs.
2. A user exit routine specified on the USERPROGRAM keyword is used in preference to one specified on the entry linkage.

**When invoked**

Invoked multiple times during processing of the EXTRACT command.

**Exit-specific parameters****EXTRACT\_FUNCTION\_CODE\_PTR**

Address of a halfword containing a code that defines the point in EXTRACT processing reached. The EXTRACT function codes are listed in EXTRACT function codes.

**EXTRACT\_WORK\_AREA\_PTR**

Address of a fullword containing the address of the EXTRACT work area.

**EXTRACT\_BACKTRAN\_COMMAND\_PTR**

Address of a fullword containing the address of the EXTRACT command being processed.

**EXTRACT\_CSD\_LIST\_NAME\_PTR**

Address of an 8-byte field containing the name of the list whose data is being extracted. This value is set only on 'list start' and 'list end' calls.

**EXTRACT\_CSD\_GROUP\_NAME\_PTR**

Address of an 8-byte field containing the name of the group whose



data is being extracted. This value is set on 'group start', 'group end', 'object start', 'object end', and 'keyword' calls.

**EXTRACT\_CSD\_OBJECT\_TYPE\_PTR**

Address of a 12-byte field that identifies the type of object (such as TRANSACTION, PROGRAM, and so on). This value is set only on 'object start', 'object end', and 'keyword' calls.

**EXTRACT\_CSD\_OBJECT\_NAME\_PTR**

Address of an 8-byte field containing the name of the object. This value is set only on 'object start', 'object end', and 'keyword' calls.

**EXTRACT\_KEYWORD\_NAME\_PTR**

Address of a 12-byte field containing the name of the keyword being processed. This value is set on 'keyword' calls only.

**EXTRACT\_KEYWORD\_LENGTH\_PTR**

Address of a halfword containing the length of the value associated with the keyword. This value is set on 'keyword' calls only.

**EXTRACT\_KEYWORD\_VALUE\_PTR**

Address of a character string which contains the value associated with the keyword. This value is set on 'keyword' calls only.

Note that these parameters are similar to those passed when DFHCSDUP is invoked as a batch program. (See "Parameters passed from DFHCSDUP to the user program" on page 815.) However, when DFHCSDUP is invoked from a user program, the parameter list also includes the standard parameters mentioned under "Parameters passed to the user exit routines" on page 824.

**Return codes**

**UERCNORM (X'00')**

Continue processing.

**UERCERR**

Irrecoverable error. This causes DFHCSDUP to terminate with a return code of '8'.

**XPI calls**

Must not be used.

## The put-message exit

The put-message exit is invoked whenever a message is to be issued. If you are running under TSO, you could use this exit to terminate DFHCSDUP after the operator inputs an ATTENTION interrupt. (See "Invoking DFHCSDUP from a user program" on page 821.) Or you could use it to provide messages in the operator's national language.

Even if this exit is supplied, messages are always additionally written to the default output file (that is, to SYSPRINT, or to the replacement ddname specified on the entry linkage to DFHCSDUP).

**When invoked**

Invoked when a message is to be issued.

**Exit-specific parameters**

**UEPMNUM**

Address of a 4-character field containing the message number

**UEPMDOM**

Reserved

**UEPINSN**

Address of a 2-byte field containing the number of insert fields

**UEPINSA**

Address of the following message structure:

	DS	F	Reserved
INS_1_TEXT_PTR	DS	A	Address of insert 1
INS_1_LEN_PTR	DS	A	Address of a fullword containing the length of insert 1
	DS	F	Reserved
	DS	F	Reserved
INS_2_TEXT_PTR	DS	A	Address of insert 2
INS_2_LEN_PTR	DS	A	Address of a fullword containing the length of insert 2
	DS	F	Reserved
	...		
	DS	F	Reserved
INS_n_TEXT_PTR	DS	A	Address of insert n
INS_n_LEN_PTR	DS	A	Address of a fullword containing the length of insert n
	DS	F	Reserved

The exit-specific parameters provide a message number and insert fields only, to enable you to provide messages in the language of your TSO operators. The structure pointed to by UEPINSA is repeated as many times as UEPINSN requires.

**Return codes****UERCNORM (X'00')**

Continue processing.

**UERCERR**

Irrecoverable error. This causes DFHCSDUP to terminate with a return code of '8'.

**XPI calls**

Must not be used.

## The termination exit

The purpose of the termination exit is to allow you to perform final housekeeping duties. It is invoked before a normal or an abnormal termination of DFHCSDUP.

**When invoked**

Invoked once, before termination of DFHCSDUP.

**Exit-specific parameters****UEPTRMFL**

Address of a 1-byte field that indicates the mode of termination. Its possible values are:

**X'00'** Normal termination**X'F0'** Abnormal termination.

Your exit program cannot reset the value in this field.

**Return codes**

**UERCNORM (X'00')**

Continue processing.

**UERCERR**

Irrecoverable error. This causes DFHCSDUP to terminate with a return code of '8'.

**XPI calls**

Must not be used.

---

## The sample program, DFH\$CUS1

The CICS-supplied sample program, DFH\$CUS1, illustrates how DFHCSDUP can be invoked from a user program. It is written as a command processor (CP) for execution under the TSO/E operating system.

Note that DFH\$CUS1 uses different DCB and ACB names from those normally used by DFHCSDUP. Ensure that these are allocated before running the program under TSO/E.

Although DFH\$CUS1 is intended to be run from TSO, you can also run it from, for example, a REXX EXEC. Before doing so, ensure that the load library that contains DFH\$CUS1, DFHCSDUP, and DFHEITCU is in the user's search chain, LOGON proc, or linklist. Figure 132 is an example REXX EXEC that invokes DFH\$CUS1.

```
/*REXX*/  
"ALLOCATE DSN('XXXXX.CICS650.DFH$CSD') DD(ALTACB) SHR"  
"ALLOC DD(SIN) DA(*) BLKSIZE(80)"  
"ALLOC DD(SPRINT) DA(*) BLKSIZE(80)"  
X = PROMPT('ON')  
ADDRESS TSO "DFH$CUS1"  
"FREE DD(ALTACB)"  
"FREE DD(SIN)"  
"FREE DD(SPRINT)"  
RETURN 0
```

Figure 132. A REXX program that invokes the DFH\$CUS1 sample program



---

## Part 9. Appendixes



---

## Appendix A. Coding entries in the VTAM LOGON mode table

This appendix shows you what to code in your VTAM LOGON mode table for a terminal to be automatically installed. It is divided into the following sections:

1. "Overview of the VTAM LOGON mode table"
2. "TYPETERM device types and pointers to related LOGON mode data"
3. "VTAM MODEENT macro operands" on page 835
4. "PSERVIC screen size values for LUTYPEx devices" on page 840
5. "Matching models and LOGON mode entries" on page 841
6. "LOGON mode definitions for CICS-supplied autoinstall models" on page 850.

---

### Overview of the VTAM LOGON mode table

CICS uses the data that you code in your VTAM LOGON mode table when processing an automatic installation (autoinstall) request. Automatic installation functions properly only if the logmode entries that you define to VTAM have matches among the TYPETERMs and model TERMINAL definitions that you specify to CICS. "Matching models and LOGON mode entries" on page 841 and "LOGON mode definitions for CICS-supplied autoinstall models" on page 850 show examples of matching definitions.

The following tables show, for a variety of possible terminal devices, what you must code on the VTAM MODEENT macros that define your logmode table if you want to use autoinstall. Between them they show the values that must be specified for each of the operands of the MODEENT macro. Where all bit settings of an operand's value have significance for CICS, the data is shown in hexadecimal form. If some of an operand's bit settings are not significant to CICS, its data bytes are shown as bit patterns. The bit settings that have significance for CICS are shown set to the values that CICS expects. Those bits that have no significance to CICS are shown as periods. Thus, for example:

```
01..0011
```

shows that six bits in the subject byte must be given specific values; the remaining two have no significance.

Some of the examples shown here correspond exactly to entries in the CICS-supplied LOGON mode table called ISTINCLM. Where this is so, the table gives the name of the entry in ISTINCLM.

The PSERVIC setting shows fields called aaaaaaaa, bbbbbbbb, and so on. The contents of these vary for LUTYPE0, LUTYPE2, and LUTYPE3 devices, according to how you specify certain attributes of the terminals. You can work out the values you need by looking at "PSERVIC screen size values for LUTYPEx devices" on page 840.

---

### TYPETERM device types and pointers to related LOGON mode data

Search Table 49 on page 834 for the TYPETERM device type that corresponds to the terminal you want to autoinstall. When you find the right one, use the number to its right to locate, in Table 50 on page 836, what has to be coded on the VTAM MODEENT macros.

Note that Table 49 is a complete list of TYPETERM device types; not all of these can be used with autoinstall. Those that cannot are marked with an asterisk (\*). For details about coding TYPETERM definitions, and for a list of terminals that can be autoinstalled, see the *CICS Resource Definition Guide*.

Table 49. TYPETERM device types, with cross-references to VTAM logmode entries

TYPETERM device type	Reference number in Table 50 on page 836
DEVICE(APPC)	24
DEVICE(BCHLU)	17
DEVICE(BCHLU) SESSIONTYPE(BATCHDI)	15
DEVICE(BCHLU) SESSIONTYPE(USERPROG)	16
DEVICE(CONTLU)	10
DEVICE(INTLU)	11
DEVICE(LUTYPE2)	18
DEVICE(LUTYPE2) TERMMODEL(1)	18
DEVICE(LUTYPE3)	19
DEVICE(LUTYPE3) TERMMODEL(1)	19
DEVICE(LUTYPE4)	12
DEVICE(SCSPRINT)	11, 13
DEVICE(TLX)	8
DEVICE(TLX) SESSIONTYPE(CONTLU)	8
DEVICE(TLX) SESSIONTYPE(INTLU)	9
DEVICE(TWX)	8
DEVICE(TWX) SESSIONTYPE(CONTLU)	8
DEVICE(TWX) SESSIONTYPE(INTLU)	9
DEVICE(3270)	2
DEVICE(3270) BRACKET(NO)	1
DEVICE(3270) TERMMODEL(1)	2
DEVICE(3270) TERMMODEL(1) BRACKET(NO)	1
DEVICE(3270P)	2
DEVICE(3270P) BRACKET(NO)	1
DEVICE(3270P) TERMMODEL(1)	2
DEVICE(3270P) TERMMODEL(1) BRACKET(NO)	1
DEVICE(3275)	2
DEVICE(3275) BRACKET(NO)	1
DEVICE(3275) TERMMODEL(1)	2
DEVICE(3275) TERMMODEL(1) BRACKET(NO)	1
DEVICE(3600)	16, 22, 23
DEVICE(3600) SESSIONTYPE(PIPELINE) *	21
DEVICE(3600) SESSIONTYPE(PIPELN) *	21
DEVICE(3614) *	3
DEVICE(3650) SESSIONTYPE(PIPELINE) *	21



Table 49. TYPETERM device types, with cross-references to VTAM logmode entries (continued)

TYPETERM device type	Reference number in Table 50 on page 836
DEVICE(3650) SESSIONTYPE(PIPELN) *	21
DEVICE(3650) SESSIONTYPE(USERPROG) BRACKET(YES)	6
DEVICE(3650) SESSIONTYPE(USERPROG) BRACKET(NO)	7
DEVICE(3650) SESSIONTYPE(3270)	5
DEVICE(3650) SESSIONTYPE(3270) BRACKET(NO)	4
DEVICE(3650) SESSIONTYPE(3653)	5
DEVICE(3650) SESSIONTYPE(3653) BRACKET(NO)	4
DEVICE(3767)	11
DEVICE(3767C)	10
DEVICE(3767I)	11
DEVICE(3770)	17
DEVICE(3770) SESSIONTYPE(BATCHDI)	15
DEVICE(3770) SESSIONTYPE(USERPROG)	16
DEVICE(3770B)	17
DEVICE(3770B) SESSIONTYPE(BATCHDI)	15
DEVICE(3770B) SESSIONTYPE(USERPROG)	16
DEVICE(3770C)	10
DEVICE(3770I)	11
DEVICE(3790)	20
DEVICE(3790) SESSIONTYPE(BATCHDI)	14
DEVICE(3790) SESSIONTYPE(SCSPRT)	13
DEVICE(3790) SESSIONTYPE(SCSPRINT)	13
DEVICE(3790) SESSIONTYPE(USERPROG)	16
DEVICE(3790) SESSIONTYPE(3277CM)	18
DEVICE(3790) SESSIONTYPE(3284CM)	19
DEVICE(3790) SESSIONTYPE(3286CM)	19

---

## VTAM MODEENT macro operands

Table 50 on page 836 VTAM LOGON mode table entry for each TYPETERM you might define. You should have reached this table by looking up the TYPETERM device types in Table 49 on page 834.

Look down the left hand side of the table for the reference number (RN) that brought you here from Table 49 on page 834. When you find it, look across to the middle column. This shows the macro operands that affect the way CICS handles automatic installation. Your MODEENT macro entries for devices to be installed must match what is specified there. Any MODEENT macro entries not shown in the

table, such as PSERVIC for some reference numbers, are not tested by CICS. Any bit settings that do not matter to CICS during bind analysis for autoinstalled terminals appear as periods (.).

**Note:** Some fields in the PSERVIC data for LUTYPE0, LUTYPE2, and LUTYPE3 devices have values that depend on the ALTSCREEN and DEFSCREEN characteristics of the device. For this reason, you have to consult “PSERVIC screen size values for LUTYPE $x$  devices” on page 840 to find out the values you need to specify instead of aaaaaaaa, bbbbbbbb, cccccccc, dddddddd, and eeeeeeee.

The right-hand column in the table names entries in the CICS-supplied LOGON mode table that could meet your needs. The CICS-supplied table is called ISTINCLM. For further VTAM information, refer to *ACF/VTAM Network Implementation Guide*.

Table 50. LOGON mode table and ISTINCLM entries

RN	VTAM MODEENT macro entries that are needed for related CICS TYPETERM definitions	Suitable supplied entries
1	FMPROF=X'02' TSPROF=X'02' PRIPROT=X'70' SECPROT=X'40' COMPROT=B'0000.000 00000.00'	
2	FMPROF=X'02' TSPROF=X'02' PRIPROT=X'71' SECPROT=X'40' COMPROT=B'0010.000 00000.00'	DSILGMOD D4B32781 D4B32782 D4B32783 D4B32784 D4B32785 NSX32702 S3270
3	FMPROF=X'04' TSPROF=X'04' PRIPROT=X'B0' SECPROT=X'B0' COMPROT=B'0000.000 00000.00'	
4	FMPROF=X'04' TSPROF=X'03' PRIPROT=X'B0' SECPROT=X'90' COMPROT=B'0100.000 00000.00'	
5	FMPROF=X'04' TSPROF=X'03' PRIPROT=X'B1' SECPROT=X'90' COMPROT=B'0110.000 00000.00'	
6	FMPROF=X'04' TSPROF=X'04' PRIPROT=X'31' SECPROT=X'30' COMPROT=B'0110.000 00000.00'	INTRUSER

Table 50. LOGON mode table and ISTINCLM entries (continued)

RN	VTAM MODEENT macro entries that are needed for related CICS TYPETERM definitions	Suitable supplied entries
7	FMPROF=X'04' TSPROF=X'04' PRIPROT=X'B0' SECPROT=X'30' COMPROT=B'0100.000 00000.00'	
8	FMPROF=X'03' TSPROF=X'03' PRIPROT=X'B1' SECPROT=X'90' COMPROT=B'0011.000 01000.00' PSERVIC=B'00000001 00000000 00000000 00000000. ..... 00000000 00000000 00000000 00000000 ..... 00000000 00000000'	
9	FMPROF=X'03' TSPROF=X'03' PRIPROT=X'B1' SECPROT=X'90' COMPROT=B'0011.000 10000.00' PSERVIC=B'00000001 00000000 00000000 00000000. ..... 00000000 00000000 00000000 00000000 ..... 00000000 00000000'	SCS
10	FMPROF=X'03' TSPROF=X'03' PRIPROT=X'B1' SECPROT=X'90' COMPROT=B'0011.000 01000.00' PSERVIC=X'01'	
11	FMPROF=X'03' TSPROF=X'03' PRIPROT=X'B1' SECPROT=X'90' COMPROT=B'0011.000 10000.00' PSERVIC=X'01'	SCS  See note 2
12	FMPROF=X'07' TSPROF=X'07' PRIPROT=X'B1' SECPROT=X'B0' COMPROT=B'0101.000 10000.01' PSERVIC=B'00000100 10101000 01000000 10100000 ..... 10101000 01000000 10100000 00000000 ..... 00001100 00000000'	
13	FMPROF=X'03' TSPROF=X'03' PRIPROT=X'B1' SECPROT=X'B0' COMPROT=B'0011.000 10000.00' PSERVIC=X'01'	SCS3790  See note 2

Table 50. LOGON mode table and ISTINCLM entries (continued)

RN	VTAM MODEENT macro entries that are needed for related CICS TYPETERM definitions	Suitable supplied entries
14	FMPROF=X'03' TSPROF=X'04' PRIPROT=X'B1' SECPROT=X'B0' COMPROT=B'0111.000 10000.00' PSERVIC=B'00000001 00110001 00011000 0100000. ..... 00000000 10010010 00000000 00000000 ..... 00000000 01010000'	
15	FMPROF=X'03' TSPROF=X'03' PRIPROT=X'B1' SECPROT=X'B0' COMPROT=B'0111.000 10000.00' PSERVIC=B'00000001 00110001 00001100 0111000. ..... 00000000 11010010 00000000 00000000 ..... 00000000 11010000'	
16	FMPROF=X'04' TSPROF=X'04' PRIPROT=X'B1' SECPROT=X'B0' COMPROT=B'0111.000 10000.00'	See note 3
17	FMPROF=X'03' TSPROF=X'03' PRIPROT=X'B1' SECPROT=X'90' COMPROT=B'0111.000 10000.00' PSERVIC=B'00000001 00100000 00000000 0000000. ..... 00000000 11000010 00000000 00000000 ..... 00000000 11000000'	
18	FMPROF=X'03' TSPROF=X'03' PRIPROT=X'B1' SECPROT=B'10..0000' COMPROT=B'0011.000 10000.00' PSERVIC=B'00000010 10000000 00000000 00000000 00000000 00000000 aaaaaaaaa bbbbbbbb cccccccc dddddddd eeeeeeee'	D329001 D4A32771 D4A32772 D4A32781 D4A32782 D4A32783 D4A32784 D4A32785 D4C32771 D4C32772 D4C32781 D4C32782 D4C32783 D4C32784 D4C32785 D6327801 D6327802 D6327803 D6327804 D6327805 EMUDPCX EMU3790 SNX32702  See note 1

Table 50. LOGON mode table and ISTINCLM entries (continued)

RN	VTAM MODEENT macro entries that are needed for related CICS TYPETERM definitions	Suitable supplied entries
19	FMPROF=X'03' TSPROF=X'03' PRIPROT=X'B1' SECPROT=B'10..0000' COMPROT=B'0011.000 10000.00' PSERVIC=B'00000011 10000000 00000000 00000000 00000000 00000000 aaaaaaaa bbbbbbbb cccccccc dddddddd eeeeeeee'	BLK3790 DSC2K DSC4K D6328902 D6328904  See note 1
20	FMPROF=X'04' TSPROF=X'03' PRIPROT=X'31' SECPROT=X'B0' COMPROT=B'0111.000'	
21	FMPROF=X'04' TSPROF=X'04' PRIPROT=X'50' SECPROT=X'10' COMPROT=B'0000.000 00000.00'	
22	FMPROF=X'04' TSPROF=X'04' PRIPROT=X'B0' SECPROT=X'B0' COMPROT=B'0100.000 00000.00'	IBMS3650
23	FMPROF=X'04' TSPROF=X'04' PRIPROT=X'B1' SECPROT=X'B0' COMPROT=B'0111.000 00000.00'	
24	TYPE=X'00' FMPROF=X'13' TSPROF=X'07' PRIPROT=X'B0' SECPROT=X'B0' COMPROT=B'.101.000 10110.01' PSERVIC=B'00000110 00000010 ..... 00000000 00000000 00000000 ..... 00000000 00000000 00000000 ..... 0010..00'	
<p><b>Notes:</b></p> <ol style="list-style-type: none"> <li>1. PSERVIC (RN 18 and 19): BYTE 2 BIT 0 should be set on where extended data stream (EXTDS) support is required.</li> <li>2. RN 11 or 13 is used to determine the MODEENT macro operands for device SCSPRINT. However, if you have specified any of the attributes EXTENDED DS, COLOR, PROGSYMBOLS, HILIGHT, SOSI, OUTLINE, QUERY(COLD), or QUERY(ALL) for the TYPETERM, then the COMPROT parameter of RN 13 should be modified to read COMPROT=B'0111.000 10000.00'.</li> <li>3. This LOGMODE may be used for either device type 4700 in half duplex mode or device types BCHLU, 3770, 3770B and 3790 with SESSIONTYPE(USERPROG). To enable these devices to be autoinstalled with the correct model, the model names list supplied to the autoinstall exit will list the names of models defined as DEVICE(3600) after the names of all other eligible models. The exit can be coded to select a name from the end of the list for a 4700 half duplex device.</li> </ol>		

## PSERVIC screen size values for LUTYPEx devices

Table 51 is to help you decide what screen size values you should specify on the PSERVIC operand of the VTAM MODEENT macro, for LUTYPE0, LUTYPE2, and LUTYPE3 devices.

If, on your CICS TYPETERM definition, you code the values shown in columns 1 through 4 of Table 51, the screen size values in the CICS model bind image are as shown in column 5. The values you code for screen sizes on the PSERVIC operand must match this.

Table 51. Autoinstall model device definition options

Device-type	DEFSCRN	ALTSCRN	QUERY	MODEL BIND
0,2,3	00,00	?	?	INVALID
0,2,3	12,40	,	?	0000000001
0,2,3	12,40	00,00	?	0C2800007E
0,2,3	12,40	YY,YY	?	0C28YYYY7F
0,2,3	24,80	,	NO	0000000002
3	24,80	,	COLD/ALL	0000000002
0,2	24,80	,	COLD/ALL	0000000003
0,2,3	24,80	00,00	?	185000007E
0,2,3	24,80	YY,YY	?	1850YYYY7F
0,2,3	XX,XX	,	?	XXXX00007E
0,2,3	XX,XX	00,00	?	XXXX00007E
0,2,3	XX,XX	YY,YY	?	XXXXYYYY7F

Where:

- 0** indicates local non-SNA 3270
- 2** indicates LUTYPE2
- 3** indicates LUTYPE3
- ,** indicates the default
- XX,XX** indicates a screen size that is not 12,40 or 24,80
- YY,YY** indicates a screen size that is not 00,00 or blanks
- ?** means any (that is, QUERY=ALLICOLDINO, and ALTSCRN=any)

CICS treats some differently-coded PSERVIC screen size specifications as equivalent. See Table 52.

Table 52. Equivalent PSERVIC screen size values

Bytes 20—24 of CICS model bind	Valid screen size values on PSERVIC definition
0000 0000 01	0000 0000 00 0000 0000 01 0C28 0000 7E
0000 0000 02	0000 0000 00 0000 0000 02 1850 0000 7E
0000 0000 03	0000 0000 00 0000 0000 03 1850 0000 03

Table 52. Equivalent PSERVIC screen size values (continued)

Bytes 20—24 of CICS model bind	Valid screen size values on PSERVIC definition
xxxx 0000 7E      Plus, if xxxx=1850	0000 0000 00 xxxx 0000 7E    0000 0000 02
xxxx yyyy 7F	0000 0000 00 xxxx yyyy 7F
Where:	
<b>xxxx</b>	indicates 2 bytes containing the default screen size, in hexadecimal
<b>yyyy</b>	indicates 2 bytes containing the alternate screen size, in hexadecimal

## Matching models and LOGON mode entries

This section contains a set of VTAM LOGON mode table definitions, and their matching CICS autoinstall definitions. Each entry consists of a VTAM logmode definition, the matching CICS TYPETERM and model TERMINAL definitions, and (for information) the BIND that CICS sends based on the specified model definition.

Note that the CICS-specific attributes are purely arbitrary. Only device attributes affect the match algorithm. It is the responsibility of the autoinstall user program to distinguish between matching models.

```
*****
1) LOCAL NON-SNA 3277 / 3278 / 3279 (without special features)
*****
MT32772  MODEENT LOGMODE=MT32772, 3277/8      MODEL 2
          TYPE=1,
          FMPROF=X'02',
          TSPROF=X'02',
          PRIPROT=X'71',
          SECPROT=X'40',
          COMPROT=X'2000',
          PSERVIC=X'00000000000000000000200'
OR
          PSERVIC=X'00000000000018502B507F00' Others
OR
          PSERVIC=X'000000000000185000007E00' Model 2, no Altscreen

TERMINAL definition
*****
AUTINSTNAME  ==> M3278A
AUTINSTMODEL ==> ONLY
GROUP        ==> PDATD
TYPETERM     ==> T3278
INSERVICE   ==> YES

TYPETERM definition
*****
TYPETERM     ==> T3278
GROUP        ==> PDATD
DEVICE       ==> 3270
TERMMODEL    ==> 2
LIGHTPEN     ==> YES
AUDIBLEALARM ==> YES
UCTRAN       ==> YES
IOAREALEN    ==> 2000,2000
ERRLASTLINE  ==> YES
ERRINTENSIFY ==> YES
USERAREALEN  ==> 32
```

```

ATI          ==> YES
TTI          ==> YES
AUTOCONNECT ==> NO
LOGONMSG     ==> YES

BIND SENT BY CICS depends on PSERVIC value on LOGMODE definition above:
EITHER      : 01020271 40200000 00000080 00000000
              00000000 00000002 00009300 00300000
OR          : 01020271 40200000 00000080 00000000
              00000018 502B507F 00009300 00300000
OR          : 01020271 40200000 00000080 00000000
Real Model 2 00000018 5000007E 00009300 00300000

```

```

*****
2) LOCAL SNA 3277/78/79 (without special features) LUTYPE2
*****

```

```

S32782  MODEENT LOGMODE=S32782,  SNA LUTYPE2 3270
          TYPE=1,
          FMPROF=X'03',
          TSPROF=X'03',
          PRIPROT=X'B1',
          SECPROT=X'B0',
          COMPROT=X'3080',
          RUSIZES=X'8585',
          PSERVIC=X'028000000000185018507F00'

```

```

TERMINAL definition
*****
AUTINSTNAME ==> M32782
AUTINSTMODEL ==> ONLY
GROUP       ==> PDATD
TYPETERM   ==> T32782
INSERVICE  ==> YES

```

```

TYPETERM definition
*****
TYPETERM   ==> T32782
GROUP      ==> PDATD
DEVICE     ==> LUTYPE2
TERMMODEL ==> 2
LIGHTPEN   ==> YES
AUDIBLEALARM ==> YES
UCTRAN     ==> YES
IOAREALEN ==> 256,256
ERRLASTLINE ==> YES
ERRINTENSIFY ==> YES
USERAREALEN ==> 32
ATI        ==> YES
TTI        ==> YES
LOGONMSG   ==> YES
DISCREQ    ==> YES
RECEIVESIZE ==> 256
BUILDCHAIN ==> YES

```

```

BIND SENT BY CICS : 010303B1 B0308000 0085C780 00028000
                   00000018 5018507F 00000000 00000000

```

```

*****
3) 3770 BATCH LU (3777)
*****

```

```

BATCH  MODEENT LOGMODE=BATCH,  3770 BATCH
        TYPE=1,
        FMPROF=X'03',
        TSPROF=X'03',
        PRIPROT=X'B1',
        SECPROT=X'B0',
        COMPROT=X'7080',
        PSERVIC=X'01310C70E100D20000E100D0'

```



```

TERMINAL definition
*****
AUTINSTNAME ==> M3770
AUTINSTMODEL ==> ONLY
GROUP ==> PDATD
TYPETERM ==> T3770
INSERVICE ==> YES

TYPETERM definition
*****
TYPETERM ==> T3770
GROUP ==> PDATD
DEVICE ==> 3770
SESSIONTYPE ==> BATCHDI
PAGESIZE ==> 12,80
DISCREQ ==> YES
AUTOPAGE ==> YES
RECEIVESIZE ==> 256
SENDSIZE ==> 256
IOAREALEN ==> 256,2048
BUILDCHAIN ==> YES
BRACKET ==> YES
ATI ==> YES
TTI ==> YES
AUTOCONNECT ==> NO
HORIZFORM ==> YES
VERTFORM ==> YES
LDCLIST ==> LDC2
Needs LDC declaration in TCT :
LDC2 DFHTCT TYPE=LDC,LOCAL=INITIAL
      DFHTCT TYPE=LDC,LDC=BCHLU
      DFHTCT TYPE=LDC,LOCAL=FINAL

BIND SENT BY CICS :          010303B1 B0708000 00000080 0001310C
                              70E100D2 0000E100 D0000000 00000000

*****
4) 6670 LUTYPE4
*****
S6670  MODEENT LOGMODE=S6670,    6670 LUTYPE4
        TYPE=1,
        FMPROF=X'07',
        TSPROF=X'07',
        RUSIZES=X'8585',
        PRIPROT=X'B1',
        SECPROT=X'B0',
        COMPROT=X'5081',
        PSERVIC=X'04A840A000A840A000000C00'

TERMINAL definition
*****
AUTINSTNAME ==> M6670
AUTINSTMODEL ==> ONLY
GROUP ==> PDATD
TYPETERM ==> T6670
INSERVICE ==> YES

TYPETERM definition
*****
TYPETERM ==> T6670
GROUP ==> PDATD
DEVICE ==> LUTYPE4
BUILDCHAIN ==> YES
DISCREQ ==> YES
RECEIVESIZE ==> 256
UCTRAN ==> YES
IOAREALEN ==> 256,4096
FORMFEED ==> YES
HORIZFORM ==> YES
VERTFORM ==> YES

```

```

ATI          ==> YES
TTI          ==> YES
PAGESIZE    ==> 50,80
AUTOPAGE    ==> YES
LOGONMSG    ==> NO
LDCLIST     ==> LDC1

```

Needs LDC declaration in TCT :

```

LDCS        DFHTCT TYPE=LDC,LDC=SYSTEM
LDC1        DFHTCT TYPE=LDC,LOCAL=INITIAL
            DFHTCT TYPE=LDC,DVC=(BLUCON,01),PROFILE=DEFAULT,LDC=PC,
            PGESIZE=(50,80),PGESTAT=AUTOPAGE
            DFHTCT TYPE=LDC,DVC=(BLUPRT,02),PROFILE=BASE,LDC=PP,
            PGESIZE=(50,80),PGESTAT=AUTOPAGE
            DFHTCT TYPE=LDC,DVC=(BLUPRT,08),PROFILE=BASE,LDC=P8,
            PGESIZE=(50,80),PGESTAT=AUTOPAGE
            DFHTCT TYPE=LDC,DVC=(BLUPRT,08),PROFILE=DEFAULT,LDC=DP,
            PGESIZE=(50,80),PGESTAT=AUTOPAGE
            DFHTCT TYPE=LDC,DVC=(BLUPCH,03),PROFILE=JOB,LDC=PM,
            PGESIZE=(50,80),PGESTAT=AUTOPAGE
            DFHTCT TYPE=LDC,DVC=(BLUPCH,03),PROFILE=DEFAULT,LDC=DM,
            PGESIZE=(50,80),PGESTAT=AUTOPAGE
            DFHTCT TYPE=LDC,DVC=(WPMED1,04),PROFILE=WPRAW,LDC=P1,
            PGESIZE=(50,80),PGESTAT=AUTOPAGE
            DFHTCT TYPE=LDC,DVC=(WPMED1,04),PROFILE=DEFAULT,LDC=D1,
            PGESIZE=(50,80),PGESTAT=AUTOPAGE
            DFHTCT TYPE=LDC,DVC=(WPMED2,05),PROFILE=OII1,LDC=P2,
            PGESIZE=(50,80),PGESTAT=AUTOPAGE
            DFHTCT TYPE=LDC,DVC=(WPMED2,05),PROFILE=DEFAULT,LDC=D2,
            PGESIZE=(50,80),PGESTAT=AUTOPAGE
            DFHTCT TYPE=LDC,DVC=(WPMED3,06),PROFILE=OII2,LDC=P3,
            PGESIZE=(50,80),PGESTAT=AUTOPAGE
            DFHTCT TYPE=LDC,DVC=(WPMED4,07),PROFILE=OII3,LDC=P4,
            PGESIZE=(50,80),PGESTAT=AUTOPAGE
            DFHTCT TYPE=LDC,LOCAL=FINAL

```

```

BIND SENT BY CICS :          010707B1 B0508100 00858580 0004A840
                              A000A840 A000000C 00000000 00000000

```

\*\*\*\*\*

5) 3790 FULL FUNCTION LU

\*\*\*\*\*

```

S3790A  MODEENT LOGMODE=S3790A,   3790 FULL FUNCTION LU
            TYPE=1,
            FMPROF=X'04',
            TSPROF=X'04',
            PRIPROT=X'B1',
            SECPROT=X'B0',
            RUSIZES=X'8585',
            COMPROT=X'7080'

```

TERMINAL definition

\*\*\*\*\*

```

AUTINSTNAME ==> M3790A
AUTINSTMODEL ==> ONLY
GROUP       ==> PDATD
TYPETERM   ==> T3790A
INSERVICE  ==> YES

```

TYPETERM definition

\*\*\*\*\*

```

TYPETERM   ==> T3790A
GROUP      ==> PDATD
DEVICE     ==> 3790
SENDSIZE   ==> 256
RECEIVESIZE ==> 256
SESSIONTYPE ==> USERPROG

```

BRACKET ==> YES  
IOAREALEN ==> 256  
ATI ==> YES  
TTI ==> YES

BIND SENT BY CICS : 010404B1 B0708000 00858580 00000000

\*\*\*\*\*  
6) 3790 BATCH DATA INTERCHANGE

\*\*\*\*\*

S3790B MODEENT LOGMODE=S3790B, 3790 BATCH  
TYPE=1,  
FMPROF=X'03',  
TSPROF=X'04',  
PRIPROT=X'B1',  
SECPROT=X'B0',  
COMPROT=X'7080',  
RUSIZES=X'8585',  
PSERVIC=X'013118400000920000E10050'

TERMINAL definition

\*\*\*\*\*

AUTINSTNAME ==> M3790B  
AUTINSTMODEL ==> ONLY  
GROUP ==> PDATD  
TYPETERM ==> T3790B  
INSERVICE ==> YES  
TERMPRIORITY ==> 50

TYPETERM definition

\*\*\*\*\*

TYPETERM ==> T3790B  
GROUP ==> PDATD  
DEVICE ==> 3790  
SESSIONTYPE ==> BATCHDI  
AUTOPAGE ==> YES  
BUILDCHAIN ==> YES  
OBOPERID ==> YES  
IOAREALEN ==> 256,2048  
RELREQ ==> YES  
SENDSIZE ==> 256  
RECEIVESIZE ==> 256  
ATI ==> YES  
TTI ==> YES  
LDCLIST ==> LDC2

Needs LDC declaration in TCT :

LDC2 DFHTCT TYPE=LDC,LOCAL=INITIAL  
DFHTCT TYPE=LDC,LDC=BCHLU  
DFHTCT TYPE=LDC,LOCAL=FINAL

BIND SENT BY CICS : 010304B1 B0708000 00858580 00013118  
40000092 0000E100 50000000 00000000

\*\*\*\*\*

7) 3790 SCSVRT

\*\*\*\*\*

S3790C MODEENT LOGMODE=S3790C, 3790 WITH SCS  
TYPE=1,  
FMPROF=X'03',  
TSPROF=X'03',  
PRIPROT=X'B1',  
SECPROT=X'B0',  
COMPROT=X'3080',  
RUSIZES=X'8585',  
PSERVIC=X'0100000000000000000000'

TERMINAL definition

\*\*\*\*\*

AUTINSTNAME ==> M3790C

```

AUTINSTMODEL ==> ONLY
GROUP ==> PDATD
TYPETERM ==> T3790C
INSERVICE ==> YES

TYPETERM definition
*****
TYPETERM ==> T3790C Note that CEDA changes DEVICE=3790,
GROUP ==> PDATD SESSIONTYPE=SCSPRT to DEVICE=SCSPRINT,
DEVICE ==> 3790 SESSIONTYPE=b1anks, PRINTERTYPE=3284.
SESSIONTYPE ==> SCSPRT
BRACKET ==> YES
SENDSIZE ==> 256
RECEIVESIZE ==> 256
ATI ==> YES
TTI ==> YES

BIND SENT BY CICS : 010303B1 B0308000 00858580 00010000
*****
8) 3767 INTERACTIVE (FLIP-FLOP) LU
*****
S3767 MODEENT LOGMODE=S3767, 3767 INTERACTIVE
TYPE=1,
FMPPROF=X'03',
TSPPROF=X'03',
PRIPROT=X'B1',
SECPRROT=X'90',
COMPRROT=X'3080',
PSERVIC=X'010000000000000000000000'

TERMINAL definition
*****
AUTINSTNAME ==> M3767
AUTINSTMODEL ==> ONLY
GROUP ==> PDATD
TERMPRIORITY ==> 60
TYPETERM ==> T3767
INSERVICE ==> YES

TYPETERM definition
*****
TYPETERM ==> T3767
GROUP ==> PDATD
DEVICE ==> 3767
VERTFORM ==> YES
HORIZFORM ==> YES
RELREQ ==> YES
DISCREQ ==> YES
IOAREALEN ==> 256
AUTOPAGE ==> NO
PAGESIZE ==> 12,80
ATI ==> YES
TTI ==> YES
BRACKET ==> YES
RECEIVESIZE ==> 256
SENDSIZE ==> 256

BIND SENT BY CICS : 010303B1 90308000 00000080 00010000
*****
9) 3650 INTERPRETER LU
(SESTYPE = USERPROG BRACKET = YES)
*****
S3650A MODEENT LOGMODE=S3650A, 3650 SESTYPE=USERPROG
TYPE=1, BRACKET=YES
FMPPROF=X'04',
TSPPROF=X'04',
PRIPROT=X'31',
SECPRROT=X'30',
COMPRROT=X'6000'

```

```

TERMINAL definition
*****
AUTINSTNAME ==> M3650A
AUTINSTMODEL ==> ONLY
GROUP ==> PDATD
TYPETERM ==> T3650A
INSERVICE ==> YES

TYPETERM definition
*****
TYPETERM ==> T3650A
GROUP ==> PDATD
DEVICE ==> 3650
SESSIONTYPE ==> USERPROG
ROUTEDMSGS ==> SPECIFIC
FMHPARM ==> YES
RELREQ ==> YES
DISCREQ ==> YES
BRACKET ==> YES
RECEIVESIZE ==> 256
IOAREALEN ==> 256,256
ATI ==> YES
TTI ==> YES
AUTOCONNECT ==> NO

BIND SENT BY CICS :          01040431 30600000 00000080 00000000
*****
10) 3650 HOST CONVERSATIONAL (3270) LU
*****
S3650B  MODEENT LOGMODE=S3650B,  3650 SESTYPE=3270
        TYPE=1,                AND SESTYPE=3653
        FMPROF=X'04',
        TSPROF=X'03',
        PRIPROT=X'B1',
        SECPROT=X'90',
        COMPROT=X'6000'

TERMINAL definition
*****
AUTINSTNAME ==> M3650B1
AUTINSTMODEL ==> ONLY
GROUP ==> PDATD
TYPETERM ==> T3650B1
INSERVICE ==> YES

TYPETERM definition
*****
TYPETERM ==> T3650B1
GROUP ==> PDATD
DEVICE ==> 3650
OBFORMAT ==> YES
SESSIONTYPE ==> 3270
RELREQ ==> YES
DISCREQ ==> YES
IOAREALEN ==> 256
BRACKET ==> YES
RECEIVESIZE ==> 240
ATI ==> NO
TTI ==> YES

BIND SENT BY CICS :          010403B1 90600000 00000080 00000000
*****
11) 3650 HOST CONVERSATIONAL (3653) LU
    (N.B. LOGMODE SAME AS HC (3270) LU)
*****
S3650B  MODEENT LOGMODE=S3650B,  3650 SESTYPE=3270
        TYPE=1,                AND SESTYPE=3653
        FMPROF=X'04',

```

```
TSPROF=X'03',
PRIPROT=X'B1',
SECPROT=X'90',
COMPROT=X'6000'
```

TERMINAL definition

```
*****
AUTINSTNAME ==> M3650B2
AUTINSTMODEL ==> ONLY
GROUP ==> PDATD
TYPETERM ==> T3650B2
INSERVICE ==> YES
```

TYPETERM definition

```
*****
TYPETERM ==> T3650B2
GROUP ==> PDATD
DEVICE ==> 3650
SESSIONTYPE ==> 3653
RELREQ ==> YES
DISCREQ ==> NO
BRACKET ==> YES
IOAREALEN ==> 256
RECEIVESIZE ==> 240
ROUTEDMSGS ==> NONE
ATI ==> NO
TTI ==> YES
```

BIND SENT BY CICS : 010403B1 90600000 00000080 00000000

\*\*\*\*\*

12) 3650 HOST COMMAND PROCESSOR LU  
(SESTYPE = USERPROG BRACKET = NO)

\*\*\*\*\*

```
S3650C MODEENT LOGMODE=S3650C, 3650 SESTYPE=USERPROG
      TYPE=1, BRACKET=NO
      FMPROF=X'04',
      TSPROF=X'04',
      PRIPROT=X'B0',
      SECPROT=X'30',
      COMPROT=X'4000'
```

TERMINAL definition

```
*****
AUTINSTNAME ==> M3650C
AUTINSTMODEL ==> ONLY
GROUP ==> PDATD
TYPETERM ==> T3650C
INSERVICE ==> YES
```

TYPETERM definition

```
*****
TYPETERM ==> T3650C
GROUP ==> PDATD
DEVICE ==> 3650
SESSIONTYPE ==> USERPROG
BRACKET ==> NO
RELREQ ==> NO
DISCREQ ==> NO
RECEIVESIZE ==> 256
IOAREALEN ==> 256
ATI ==> YES
TTI ==> YES
```

BIND SENT BY CICS : 01040430 30400000 00000080 00000000

\*\*\*\*\*

13) 8815 SCANMASTER (APPC SINGLE SESSION)

\*\*\*\*\*

```
SIN62 MODEENT LOGMODE=SIN62, 8815 SCANMASTER.
      TYPE=0,
      FMPROF=X'13',
```

```

TSPROF=X'07',
PRIPROT=X'B0',
SECPROT=X'B0',
COMPROT=X'50B1',
PSNDPAC=X'00',
SRCVPAC=X'00',
SSNDPAC=X'00',
RUSIZES=X'8585',
PSERVIC=X'06020000000000000002C00'

```

TERMINAL definition

```

*****
AUTINSTNAME ==> MLU62
AUTINSTMODEL ==> ONLY
GROUP ==> PDATD
TYPETERM ==> SINLU62
INSERVICE ==> YES

```

TYPETERM definition

```

*****
TYPETERM ==> SINLU62
GROUP ==> PDATD
DEVICE ==> APPC
RECEIVESIZE ==> 2048
SENDSIZE ==> 2048
ATI ==> YES
TTI ==> YES

```

Note: There is no RDO keyword equivalent of the MACRO keyword 'FEATURE=SINGLE', because this is assumed with RDO DEFINE TYPETERM when DEVICE=APPC.

```

BIND SENT BY CICS :      001307B0 B050B100 00858580 00060200
                        00000000 0000002C 00000800 00000000
                        0000001D 00090240 40404040 40404009
                        03006765 71D98A6C 300704C3 C9C3E2E6
                        F1000000 00000000 00000000 00000000

```

\*\*\*\*\*  
14) 3290 (SDLC)

```

*****
S3290  MODEENT LOGMODE=S3290,  3290 SDLC
        TYPE=1,
        FMPROF=X'03',
        TSPROF=X'03',
        PRIPROT=X'B1',
        SECPROT=X'90',
        COMPROT=X'3080',
        RUSIZES=X'8787',
        PSERVIC=X'02800000000018503EA07F00'

```

TERMINAL definition

```

*****
AUTINSTNAME ==> M3290
AUTINSTMODEL ==> ONLY
GROUP ==> PDATD
TYPETERM ==> T3290
INSERVICE ==> YES

```

TYPETERM definition

```

*****
TYPETERM ==> T3290
GROUP ==> PDATD
DEVICE ==> LUTYPE2
TERMMODEL ==> 2
ALTSCREEN ==> 62,160
DEFSCREEN ==> 24,80
AUDIBLEALARM ==> YES
UCTRAN ==> YES
IOAREALEN ==> 2000,2000
ERRLASTLINE ==> YES
ERRINTENSIFY ==> YES

```

```

USERAREALEN ==> 32
ATI ==> YES
TTI ==> YES
LOGONMSG ==> YES
ERRHILIGHT ==> BLINK
RECEIVESIZE ==> 1024
BIND SENT BY CICS :          010303B1 90308000 00878780 00028000
                              00000018 503EA07F 00000000 00000000

*****
15) 3601 WITH A 3604 ATTACHED
*****
S3600  MODEENT LOGMODE=S3600,  3601
        TYPE=1,
        FMPROF=X'04',
        TSPROF=X'04',
        PRIPROT=X'B1',
        SECPROT=X'B0',
        COMPROT=X'7000',
        RUSIZES=X'0000'

TERMINAL definition
*****
AUTINSTNAME ==> M3600
AUTINSTMODEL ==> ONLY
GROUP ==> PDATD
TERMPRIORITY ==> 50
TYPETERM ==> T3600
INSERVICE ==> YES

TYPETERM definition
*****
TYPETERM ==> T3600
GROUP ==> PDATD
DEVICE ==> 3600
AUTOPAGE ==> NO
PAGESIZE ==> 6,40
RELREQ ==> YES
DISCREQ ==> NO
IOAREALEN ==> 256
SENDSIZE ==> 224
RECEIVESIZE ==> 256
USERAREALEN ==> 100
ATI ==> NO
TTI ==> YES
BRACKET ==> YES
LDCLIST ==> BMSLLDC1

Needs LDC declaration in TCT :
BMSLLDC1 DFHTCT TYPE=LDCLIST,
          LDC=(DS,JP,PB=5,LP,MS)
          DFHTCT TYPE=LDC,
          LDC=(DS=1),
          DVC=3604,
          PGESIZE=(6,40),
          PGESTAT=PAGE
          DFHTCT TYPE=LDC,LDC=SYSTEM

BIND SENT BY CICS :          010404B1 B0700000 00000080 00000000

```

---

## LOGON mode definitions for CICS-supplied autoinstall models

This section contains VTAM LOGON mode table definitions that match the CICS-supplied TYPETERM and model TERMINAL definitions for autoinstall. The first six entries are example definitions; that is, they are not supplied with VTAM.



```

DFHLU3  MODEENT LOGMODE=DFHLU3,  LU TYPE 3 PRINTER.
        TYPE=1,
        FMPROF=X'03',
        TSPROF=X'03',
        PRIPROT=X'B1',
        SECPROT=X'B0',
        COMPROT=X'3080',
        RUSIZES=X'8585',
        PSERVIC=X'03800000000000000000200'

DFHSCSP  MODEENT LOGMODE=DFHSCSP,  LU TYPE 1 SCS PRINTER
        TYPE=1,
        FMPROF=X'03',
        TSPROF=X'03',
        PRIPROT=X'B1',
        SECPROT=X'B0',
        COMPROT=X'7080',
        RUSIZES=X'8585',
        PSERVIC=X'010000010000000000000000'

DFHLU62T  MODEENT LOGMODE=DFHLU62T,  APPC SINGLE-SESSION
        TYPE=0,
        FMPROF=X'13',
        TSPROF=X'07',
        PRIPROT=X'B0',
        SECPROT=X'B0',
        COMPROT=X'50B1',
        RUSIZES=X'8888',
        PSERVIC=X'060200000000000000002C00'

DFH3270  MODEENT LOGMODE=DFH3270,  3270
        TYPE=1,
        FMPROF=X'02',
        TSPROF=X'02',
        PRIPROT=X'71',
        SECPROT=X'40',
        COMPROT=X'2000',
        RUSIZES=X'0000'

DFH3270P  MODEENT LOGMODE=DFH3270P,  3284/3286 BISYNC 3270P (QUERY)
        TYPE=1,
        FMPROF=X'02',
        TSPROF=X'02',
        PRIPROT=X'71',
        SECPROT=X'40',
        COMPROT=X'2000',
        RUSIZES=X'0000'

DFHLU2  MODEENT LOGMODE=DFHLU2,  SNA LUTYPE2 3270
        TYPE=1,
        FMPROF=X'03',
        TSPROF=X'03',
        PRIPROT=X'B1',
        SECPROT=X'B0',
        COMPROT=X'3080',
        RUSIZES=X'85C7',
        PSERVIC=X'0280000000000000000000300'

```

The following entries are those LOGMODE definitions supplied by VTAM that match CICS-supplied TYPETERM definitions.

```

DFHLU0E2  MODEENT LOGMODE=NSX32702,  LU0 model 2 queryable
        FMPROF=X'02',
        TSPROF=X'02',
        PRIPROT=X'71',
        SECPROT=X'40',
        COMPROT=X'2000',
        RUSIZES=X'0000',
        PSERVIC=X'008000000000185000007E00'

```

```

DFHLU0M2 MODEENT LOGMODE=D4B32782, LU0 model 2 nonqueryable
    FMPROF=X'02',
    TSPROF=X'02',
    PRIPROT=X'71',
    SECPROT=X'40',
    COMPROT=X'2000',
    RUSIZES=X'0000',
    PSERVIC=X'000000000000185000007E00'

DFHLU0M3 MODEENT LOGMODE=D4B32783, LU0 model 3 nonqueryable
    FMPROF=X'02',
    TSPROF=X'02',
    PRIPROT=X'71',
    SECPROT=X'40',
    COMPROT=X'2000',
    RUSIZES=X'0000',
    PSERVIC=X'000000000000185020507F00'

DFHLU0M4 MODEENT LOGMODE=D4B32784, LU0 model 4 nonqueryable
    FMPROF=X'02',
    TSPROF=X'02',
    PRIPROT=X'71',
    SECPROT=X'40',
    COMPROT=X'2000',
    RUSIZES=X'0000',
    PSERVIC=X'00000000000018502B507F00'

DFHLU0M5 MODEENT LOGMODE=D4B32785, LU0 model 5 nonqueryable
    FMPROF=X'02',
    TSPROF=X'02',
    PRIPROT=X'71',
    SECPROT=X'40',
    COMPROT=X'2000',
    RUSIZES=X'0000',
    PSERVIC=X'00000000000018501B847F00'

DFHLU2E2 MODEENT LOGMODE=SNX32702, LU2 model 2 queryable
    FMPROF=X'03',
    TSPROF=X'03',
    PRIPROT=X'B1',
    SECPROT=X'90',
    COMPROT=X'3080',
    RUSIZES=X'87F8',
    PSERVIC=X'028000000000185000007E00'

DFHLU2E3 MODEENT LOGMODE=SNX32703, LU2 model 3 queryable
    FMPROF=X'03',
    TSPROF=X'03',
    PRIPROT=X'B1',
    SECPROT=X'90',
    COMPROT=X'3080',
    RUSIZES=X'87F8',
    PSERVIC=X'028000000000185020507F00'

DFHLU2E4 MODEENT LOGMODE=SNX32704, LU2 model 4 queryable
    FMPROF=X'03',
    TSPROF=X'03',
    PRIPROT=X'B1',
    SECPROT=X'90',
    COMPROT=X'3080',
    RUSIZES=X'87F8',
    PSERVIC=X'02800000000018502B507F00'

DFHLU2M2 MODEENT LOGMODE=D4A32782, LU2 model 2 nonqueryable
    FMPROF=X'03',
    TSPROF=X'03',
    PRIPROT=X'B1',
    SECPROT=X'90',
    COMPROT=X'3080',
    RUSIZES=X'87C7',
    PSERVIC=X'020000000000185000007E00'

```

```
DFHLU2M3 MODEENT LOGMODE=D4A32783, LU2 model 3 nonqueryable
      FMPROF=X'03',
      TSPROF=X'03',
      PRIPROT=X'B1',
      SECPROT=X'90',
      COMPROT=X'3080',
      RUSIZES=X'87C7',
      PSERVIC=X'020000000000185020507F00'

DFHLU2M4 MODEENT LOGMODE=D4A32784, LU2 model 4 nonqueryable
      FMPROF=X'03',
      TSPROF=X'03',
      PRIPROT=X'B1',
      SECPROT=X'90',
      COMPROT=X'3080',
      RUSIZES=X'87C7',
      PSERVIC=X'02000000000018502B507F00'

DFHLU2M5 MODEENT LOGMODE=D4A32785, LU2 model 5 nonqueryable
      FMPROF=X'03',
      TSPROF=X'03',
      PRIPROT=X'B1',
      SECPROT=X'90',
      COMPROT=X'3080',
      RUSIZES=X'87C7',
      PSERVIC=X'02000000000018501B847F00'
```



---

## Appendix B. Default actions of the node abnormal condition program

This appendix describes the default actions of the node abnormal condition program, DFHZNAC. The actions vary, depending on the terminal error code and system sense codes received from VTAM. In most cases, DFHZNAC issues messages and sets one or more “action flags” in the communication area passed to the node error program, DFHZNEP. DFHZNEP then has the opportunity to change the default actions (though not the messages) by setting or resetting flags. (Note, however, that in some circumstances, the actions actually taken can vary from the actions set, depending on the state of the node at the time of the error.)

For more information about DFHZNAC and DFHZNEP, see Chapter 9, “Writing a node error program,” on page 479.

The appendix is divided into the following sections:

1. “DFHZNAC—default actions for terminal error codes”
2. “CICS messages associated with VTAM errors” on page 861
3. “DFHZNAC—default actions for system sense codes” on page 866
4. “Action flag settings and meanings” on page 868.

---

### DFHZNAC—default actions for terminal error codes

Terminal error codes from VTAM are put in a 1-byte field (TWAEC) of the communications area passed to DFHZNEP.

Table 53 shows the message issued and action flags set by DFHZNAC for each terminal error code.

For error codes with CICS messages associated with them, see the *CICS Messages and Codes* manual for descriptions of the corresponding error conditions.

The figures in the “**Action flags set**” column are translated into bit settings and explained in Table 56 on page 868.

Table 53. Messages issued and flags set by DFHZNAC for specific error codes

Error code	Symbolic label	Message	Action flags set
X'10'	TCZSRCTU	DFHZC2405	18
X'11'	TCZSRCBF	DFHZC2403	2 5 7 18 24
X'13'	TCZSRCVH	DFHZC2416	7 18 24
X'14'	TCZLRCER	DFHZC2404	2 3 7 9 10 11 23 24
X'15'	TCZSRCPF	DFHZC2407	2 3 7 9 10 11 24
X'16'	TCZDMIT	DFHZC3492	None
X'18'	TCZLRCNR	DFHZC2404	2 3 7 9 10 11 23 24
X'19'	TCZSRCTS	DFHZC2406	9 10 11 18
X'1A'	TCZSRCVE	DFHZC2408	2 3 7 9 10 11 24
X'1D'	TCZSRCVI	DFHZC2417	2 7 24
X'1E'	TCZSRCV2	DFHZC2408	2 3 7 9 10 11 24

Table 53. Messages issued and flags set by DFHZNAC for specific error codes (continued)

Error code	Symbolic label	Message	Action flags set
X'20'	TCZVTAMI	DFHZC2417	None
X'21'	TCZLUCF1	DFHZC4902	3 7 9 10 11 24
X'22'	TCZLUCF2	DFHZC4903	3 7 9 10 11 24
X'23'	TCZFSMBE	DFHZC4904	3 7 9 10 11 24
X'24'	TCZFSMCS	DFHZC4905	3 7 9 10 11 24
X'25'	TCZFSMCR	DFHZC4906	3 7 9 10 11 24
X'26'	TCZSDLER	DFHZC4907	3 7 9 10 11 24
X'28'	TCZRVLER	DFHZC4909	3 7 9 10 11 24
X'29'	TCZRVLRB	DFHZC4910	3 7 9 10 11 24
X'2A'	TCZRLPEX	DFHZC4911	2 3 7 9 10 11 24
X'2B'	TCZRLPBD	DFHZC4912	2 3 7 9 10 11 24
X'2C'	TCZRLPDR	DFHZC4913	2 3 7 9 10 11 24
X'2D'	TCZRLPIL	DFHZC4914	2 3 7 9 10 11 24
X'2E'	TCZRLPEC	DFHZC4915	2 3 7 9 10 11 24
X'2F'	TCZRLPRR	DFHZC4916	2 3 7 9 10 11 24
X'30'	TCZRLPIF	DFHZC4917	2 3 7 9 10 11 24
X'31'	TCZRLPIR	DFHZC4918	2 3 7 9 10 11 24
X'32'	TCZRLXCL	DFHZC4922	7 20
X'33'	TCZIVIND	DFHZC4919	2 3 7 9 10 11 24
X'34'	TCZIVDAT	DFHZC4920	2 3 7 9 10 11 24
X'35'	TCZRTMT	DFHZC4930	2 3 7 9 10 11 24
X'36'	TCZXSBL	None	24
X'37'	TCZXSHRA	DFHZC3470	9 10 11 24
X'38'	TCZXSWAS	DFHZC6596	2 3 7 15 24
X'39'	TCZXSABN	DFHZC6595	2 3 5 7 24
X'3A'	TCZXSHR	DFHZC6594	7 24
X'3B'	TCZXSBC	DFHZC6593	None
X'3C'	TCZXUVAR	DFHZC3488	2 3 7 9 10 11 24
X'3D'	TCZXMSG	None	None
X'3E'	TCZXERR	DFHZC6591	7 9 10 11 15 24
X'3F'	TCZXRST	DFHZC6590	None
X'40'	TCZINCPY	DFHZC2489	3 9 11
X'41'	TCZTOLRQ	DFHZC2490	2 3 7 9 10 11 15 24
X'42'	TCZUNPRT	DFHZC2497 <sup>1</sup>	None
X'43'	TCZCPYNS	DFHZC2434	3 11
X'44'	TCZSRCDE	DFHZC2456	2 3 7 9 10 11 24
X'45'	TCZCHMX	DFHZC3400	3 10 11 22
X'46'	TCZOCIR	DFHZC3402	3 9 10 11
X'47'	TCZGMMS	None <sup>2</sup>	13
X'48'	TCZOPSIN	DFHZC3461	7 , 8

Table 53. Messages issued and flags set by DFHZNAC for specific error codes (continued)

Error code	Symbolic label	Message	Action flags set
X'49'	TCZCLSIN	DFHZC3462	7
X'4A'	TCZOPACB	DFHZC3463	None
X'4B'	TCZICPUT	DFHZC2498	None
X'4C'	TCZDSPCL	DFHZC3481	2 3 7 9 10 11 24
X'4D'	TCZSLSRL	DFHZC3473	None
X'4E'	TCZUNBFE	DFHZC3479	2 3 7 9 10 11 24
X'4F'	TCZCNOS0	None	None
X'50'	TCZSDRE3	DFHZC3417	3 7 9 10 11 24
X'51'	TCZBDPRI	DFHZC3418	3 7 9 10 11 24
X'52'	TCZBDUAC	DFHZC3419	2 3 5 7
X'53'	TCZBDTOS	DFHZC3420	7 20
X'54'	TCZUNBIS	DFHZC3434	2 3 7 9 10 11 24
X'55'	TCZEMWBK	DFHZC3440	None
X'56'	TCZXRFVS	DFHZC6598	None
X'57'	TCZRELIS	DFHZC3464	7 20
X'58'	TCZERMGR	DFHZC3433	7
X'59'	TCZROCT	DFHZC2443	2 3 7 9 10 11 24
X'5A'	TCZSBIRV	DFHZC3421	7 20
X'5B'	TCZNSP01	DFHZC3422	2 3 7 9 10 11 18 24
X'5C'	TCZNSP02	DFHZC3424	7 9 10 11 15 24
X'5D'	TCZPRDTO	DFHZC0101	None
X'5E'	TCZBRUAC	DFHZC3454	2 3 5 7 18 24
X'5F'	TCZBDSQP	DFHZC3455	2 3 5 7 18 24
X'60'	TCZUNCMD	DFHZC2421	2 3 7 9 10 11 24
X'62'	TCZVTAMQ	None <sup>3</sup>	24
X'63'	TCZVTAMO	DFHZC3441	None
X'64'	TCZVTAMA	DFHZC3443	None
X'65'	TCZINVR	DFHZC2448	2 3 7 10 11 22 23 24
X'66'	TCZSIGR	DFHZC3452	None
X'67'	TCZVTAMK	DFHZC3442	None
X'69'	TCZSEXOS	DFHZC3466	7 20 23
X'6A'	TCZTIOAE	DFHZC3444	1 2 3 7 9 10 11 24
X'6B'	TCZNOTNA	DFHZC3495	7 24
X'6C'	TCZPSAF	DFHZC0155	3 6 7 9 10 11 24
X'6D'	TCZPSAR	DFHZC0156	7
X'70'	TCZCLRRV	DFHZC3468	7 9 10 11 15 24
X'71'	TCZPSLE	DFHZC0147	3 6 7 9 10 11 24
X'72'	TCZPSVF	DFHZC0148	7 9 10 11 24
X'73'	TCZSDSE4	DFHZC2437	3 9 11
X'74'	TCZSDSE5	DFHZC2423	3 7 9 10 11 24

Table 53. Messages issued and flags set by DFHZNAC for specific error codes (continued)

Error code	Symbolic label	Message	Action flags set
X'75'	TCZSESE1	DFHZC2424	3 7 9 10 11 15 24
X'76'	TCZLGNA	DFHZC2487	3
X'77'	TCZDMRY	DFHZC2488	None
X'78'	TCZSDRE2	DFHZC2430	3 9 11 22
X'79'	TCZPSRAF	DFHZC0145	3 6 7 9 10 11 24
X'7A'	TCZPSRAC	DFHZC0144	7 11
X'7C'	TCZPSANR	DFHZC0157	3 7 9 10 11 24
X'7D'	TCZRABUS	DFHZC4949	2 3 7 9 10 11 24
X'80'	TCZSRCSP	DFHZC2414	None
X'81'	TCZSSXNR	DFHZC2432	None
X'82'	TCZSSXUC	DFHZC2419	2 3 7 9 10 11 23 24
X'83'	TCZSSXAR	DFHZC2450	None
X'84'	TCZSSXIB	DFHZC2446	2 3 7 9 10 11 23 24
X'85'	TCZUNEGR	DFHZC3409	2 3 7 9 10 11 23 24
X'88'	TCZLEXCI	DFHZC2467	2 3 7 9 10 11 23 24
X'89'	TCZLEXUS	DFHZC2468	2 3 7 9 10 11 24
X'8A'	TCZLUSRR	DFHZC4937	2 3 5 7 24
X'8B'	TCZLUSRF	DFHZC4938	2 3 5 7 24
X'8C'	TCZLUPUN	DFHZC4939	2 3 5 7 24
X'8D'	TCZLUPLK	DFHZC4941	2 3 5 7 24
X'8E'	TCZLUPEX	DFHZC4942	2 3 5 7 24
X'8F'	TCZLUSKN	DFHZC4940	2 3 5 7 24
X'90'	TCZLGCER	DFHZC2422	1 2 3 6 9 10 11 23 24
X'91'	TCZRSTLE	DFHZC2429	3 10 11
X'92'	TCZSDSE6	DFHZC2428	3 9 11
X'93'	TCZRACET	DFHZC2455	2 3 9 10 11
X'94'	TCZRACES	DFHZC2426	2 3 9 10 11 22
X'95'	TCZSDSE8	DFHZC2445	3 9 11
X'96'	TCZRVSZ1	DFHZC2435	3 7 10 11 24
X'97'	TCZRVSZ3	DFHZC2436	3 10 11
X'98'	TCZACT01	DFHZC2439	2 18
X'99'	TCZSDSE7	DFHZC2459	3 9 11
X'9A'	TCZDOMCF	DFHZC2447	3 9 10 11 23
X'9B'	TCZRACNL	DFHZC2486	3
X'9D'	TCZRSPER	DFHZC3465	1 2 3 7 9 10 11 23
X'9E'	TCZDEVND	DFHZC3472	None
X'A0'	TCZNOISC	DFHZC3480	7 23 24
X'A1'	TCZRVSZ2	DFHZC2438	3 10 11
X'A2'	TCZPRGE	DFHZC4945	3 7 9 10 11 24
X'A3'	TCZBKTSE	DFHZC2444	2 3 7 9 10 11 24



Table 53. Messages issued and flags set by DFHZNAC for specific error codes (continued)

Error code	Symbolic label	Message	Action flags set
X'A7'	TCZBOEB	DFHZC2449	2 3 7 11 18 22 24
X'A8'	TCZFMHLE	DFHZC2471	2 3 4 7 10 11 22 24
X'A9'	TCZRACRF	DFHZC2472	11
X'AA'	TCZSDSE9	DFHZC2473	3 9 11
X'AB'	TCZLUERR	DFHZC3470	7 9 10 11 24
X'AC'	TCZVRDAC	DFHZC3474	7 9 10 11 24
X'AD'	TCZNRLUF	DFHZC3475	7 9 10 11 24
X'AE'	TCZRCLUF	DFHZC3476	7 9 10 11 24
X'AF'	TCZCLEAN	DFHZC3477	7 9 10 11 24
X'B0'	TCZEXRO	DFHZC3491	7 15 24
X'B1'	TCZRPLAC	DFHZC2401	2 3 7 9 10 11 23 24
X'B2'	TCZSDAUC	DFHZC2425	3 7 9 10 11 15 24
X'B3'	TCZBDBND	DFHZC4929	2 3 5 7 24
X'B4'	TCZRSNE	DFHZC2402	3 11
X'B5'	TCZSAXUC	DFHZC2420	2 3 7 9 10 11 23 24
X'B6'	TCZNSEED	DFHZC4924	2 3 5 7 24
X'B7'	TCZASINC	DFHZC4925	2 3 5 7 24
X'B8'	TCZEVBAD	DFHZC4926	2 3 5 7 24
X'B9'	TCZFMH12	DFHZC4927	2 3 5 7 24
X'BB'	TCZSEXUC	DFHZC2418	2 3 7 9 10 11 23 24
X'BC'	TCZINIIR	DFHZC3410	2 3 9 10 11
X'BD'	TCZDESGM	DFHZC4928	7 24
X'BE'	TCZBFAL	DFHZC4944	2 3 5 24
X'BF'	TCZCPFAL	DFHZC3490	7 24
X'C0'	TCZDWEGF	DFHZC3499	None
X'C1'	TCZSRCAT	DFHZC2400	2 3 7 9 10 11 23 24
X'C2'	TCZLUINP	DFHZC3486	7 24
X'C3'	TCZCPFAL	DFHZC3490	24
X'C5'	TCZSRCNA	DFHZC2427	2
X'C6'	TCZPASSD	DFHZC3484	None
X'C7'	TCZPSPRE	DFHZC3485	7 24
X'C8'	TCZLUINH	DFHZC3489	7 18 24
X'C9'	TCZNPSAU	DFHZC3487	7 24
X'CB'	TCZSRCTC	DFHZC2431	2 3 9 10 11
X'CC'	TCZSRCCI	DFHZC2451	2 3 9 10 11
X'CD'	TCZSRCCX	DFHZC2454	2 3 9 10 11
X'CE'	TCZVHOLD	DFHZC3469	7 9 10 11 24
X'CF'	TCZVRNOP	DFHZC3471	7 9 10 11 24
X'D0'	TCZTXCS	DFHZC2409	2 3 7 9 10 11 15 24
X'D1'	TCZTXCU	DFHZC2410	2 3 7 9 10 11 24

Table 53. Messages issued and flags set by DFHZNAC for specific error codes (continued)

Error code	Symbolic label	Message	Action flags set
X'D3'	TCZDMPD	DFHZC2463	None
X'D4'	TCZCXRR	DFHZC2453	1 2 3 9 10
X'D5'	TCZCXE2	DFHZC2452	3 7 9 10 11 18 24
X'D6'	TCZSXC2	DFHZC2441	None
X'D7'	TCZSXC1	DFHZC2440	None
X'D8'	TCZRNCH	DFHZC2457	2 3 7 9 10 11 24
X'D9'	TCZYX43	DFHZC2469	2 3 9 10 11
X'DA'	TCZSXC3	DFHZC2470	7 9 10 11 24
X'DB'	TCZPIPL	DFHZC2117	7 9 10 11 23 24
X'DC'	TCZPXE1	DFHZC2442	None
X'DD'	TCZPXE2	DFHZC2458	None
X'DE'	TCZPIPP	DFHZC2119	7 9 10 11 23 24
X'DF'	TCZDMGF	DFHZC3482	None
X'E0'	TCZDMSN	DFHZC2411	None
X'E1'	TCZDMRA	DFHZC2412	None
X'E2'	TCZDMCL	DFHZC2413	2
X'E3'	TCZCNCL	DFHZC2485	3 9 10 11
X'E4'	TCZAIER	DFHZC2433	None
X'E6'	TCZDMLG	DFHZC2404	None
X'E8'	TCZDMSLE	DFHZC3416	2 3
X'E9'	TCZSTIND	DFHZC2102	3
X'EA'	TCZSTLER	DFHZC3432	2 3
X'EB'	TCZSTRMH	DFHZC3428	3
X'EC'	TCZSTRMM	DFHZC3429	2 3 7
X'ED'	TCZSTON	DFHZC3430	2 3
X'EF'	TCZSTIN	DFHZC3431	2 3
X'F1'	TCZBDMOD	DFHZC4931	7 18 24
X'F2'	TCZEXRVT	DFHZC2469	2 3 9 10 11
X'F3'	TCZICTYP	DFHZC4932	2 3 7 24
X'F4'	TCZIDBA	DFHZC4933	2 3 24
X'F5'	TCZISYNL	DFHZC4934	2 3 7 24
X'F6'	TCZIUOW	DFHZC4935	2 3 7 24
X'F7'	TCZIFMHL	DFHZC4936	2 3 7 24
X'F8'	TCZFSMRB	DFHZC4943	3 7 9 10 11 24
X'F9'	TCZINVAT	DFHZC4946	2 3 7 24
X'FA'	TCZLUSEC	DFHZC4947	2 3 7 24
X'FB'	TCZPSUNB	DFHZC0125	7
X'FC'	TCZPSOPN	DFHZC0131	7
X'FD'	TCZPSRC	DFHZC0146	7
X'FE'	TCZPSRF	DFHZC0150	3 6 7 9 10 11 15 24

Table 53. Messages issued and flags set by DFHZNAC for specific error codes (continued)

Error code	Symbolic label	Message	Action flags set
X'FF'	TCZPSPE	DFHZC0149	7

**Note:**

1. See message DFHZC2497 or DFHZC3493, depending on the device type.
2. "Good morning" message to be sent.
3. Cancel task, and close VTAM session owing to quick close or abend.

## CICS messages associated with VTAM errors

Table 54. CICS messages associated with VTAM errors

Message	Symbolic label	Error code	Action flags set
DFHZC0101	TCZPRDIO	X'5D'	None
DFHZC0125	TCZPSUNB	X'FB'	7
DFHZC0131	TCZPSOPN	X'FC'	7
DFHZC0144	TCZPSRAC	X'7A'	7 11
DFHZC0145	TCZPSRAF	X'79'	3 6 7 9 10 11 24
DFHZC0146	TCZPSRC	X'FD'	7
DFHZC0147	TCZPSLE	X'71'	3 6 7 9 10 11 24
DFHZC0148	TCZPSVF	X'72'	7 9 10 11 24
DFHZC0149	TCZPSPE	X'FF'	7
DFHZC0150	TCZPSRF	X'FE'	3 6 7 9 10 11 15 24
DFHZC0155	TCZPSAF	X'6C'	3 6 7 9 10 11 24
DFHZC0156	TCZPSAR	X'6D'	7
DFHZC0157	TCZPSANR	X'7C'	3 7 9 10 11 24
DFHZC2102	TCZSTIND	X'E9'	3
DFHZC2117	TCZPIPL	X'DB'	7 9 10 11 23 24
DFHZC2119	TCZPIPP	X'DE'	7 9 10 11 23 24
DFHZC2400	TCZSRCAT	X'C1'	2 3 7 9 10 11 23 24
DFHZC2401	TCZRPLAC	X'B1'	2 3 7 9 10 11 23 24
DFHZC2402	TCZRSNE	X'B4'	3 11
DFHZC2403	TCZSRCBF	X'11'	2 5 7 18 24
DFHZC2404	TCZLRCER	X'14'	2 3 7 9 10 11 23 24
DFHZC2404	TCZLRCNR	X'18'	2 3 7 9 10 11 23 24
DFHZC2404	TCZDMLG	X'E6'	None
DFHZC2405	TCZSRCTU	X'10'	18
DFHZC2406	TCZSRCTS	X'19'	9 10 11 18
DFHZC2407	TCZSRCPF	X'15'	2 3 7 9 10 11 24
DFHZC2408	TCZSRCVE	X'1A'	2 3 7 9 10 11 24
DFHZC2408	TCZSRCV2	X'1E'	2 3 7 9 10 11 24
DFHZC2409	TCZTXCS	X'D0'	2 3 7 9 10 11 15 24

Table 54. CICS messages associated with VTAM errors (continued)

Message	Symbolic label	Error code	Action flags set
DFHZC2410	TCZTXCU	X'D1'	2 3 7 9 10 11 24
DFHZC2411	TCZDMSN	X'E0'	None
DFHZC2412	TCZDMRA	X'E1'	None
DFHZC2413	TCZDMCL	X'E2'	2
DFHZC2414	TCZSRCSP	X'80'	None
DFHZC2416	TCZSRCVH	X'13'	7 18 24
DFHZC2417	TCZSRCVI	X'1D'	2 7 24
DFHZC2417	TCZVTAMI	X'20'	None
DFHZC2418	TCZSEXUC	X'BB'	2 3 7 9 10 11 23 24
DFHZC2419	TCZSSXUC	X'82'	2 3 7 9 10 11 23 24
DFHZC2420	TCZSAXUC	X'B5'	2 3 7 9 10 11 23 24
DFHZC2421	TCZUNCMD	X'60'	2 3 7 9 10 11 24
DFHZC2422	TCZLGCER	X'90'	1 2 3 6 9 10 11 23 24
DFHZC2423	TCZSDSE5	X'74'	3 7 9 10 11 24
DFHZC2424	TCZSESE1	X'75'	3 7 9 10 11 15 24
DFHZC2425	TCZSDAUC	X'B2'	3 7 9 10 11 15 24
DFHZC2426	TCZRACES	X'94'	2 3 9 10 11 22
DFHZC2427	TCZSRCNA	X'C5'	2
DFHZC2428	TCZSDSE6	X'92'	3 9 11
DFHZC2429	TCZRSTLE	X'91'	3 10 11
DFHZC2430	TCZSDRE2	X'78'	3 9 11 22
DFHZC2431	TCZSRCTC	X'CB'	2 3 9 10 11
DFHZC2432	TCZSSXNR	X'81'	None
DFHZC2433	TCZAIER	X'E4'	None
DFHZC2434	TCZCPYNS	X'43'	3 11
DFHZC2435	TCZRVSZ1	X'96'	3 7 10 11 24
DFHZC2436	TCZRVSZ3	X'97'	3 10 11
DFHZC2437	TCZSDSE4	X'73'	3 9 11
DFHZC2438	TCZRVSZ2	X'A1'	3 10 11
DFHZC2439	TCZACT01	X'98'	2 18
DFHZC2440	TCZSXC1	X'D7'	None
DFHZC2441	TCZSXC2	X'D6'	None
DFHZC2442	TCZPXE1	X'DC'	None
DFHZC2443	TCZROCT	X'59'	2 3 7 9 10 11 24
DFHZC2444	TCZBKTSE	X'A3'	2 3 7 9 10 11 24
DFHZC2445	TCZSDSE8	X'95'	3 9 11
DFHZC2446	TCZSSXIB	X'84'	2 3 7 9 10 11 23 24
DFHZC2447	TCZDOMCF	X'9A'	3 9 10 11 23
DFHZC2448	TCZINVRR	X'65'	2 3 7 10 11 22 23 24
DFHZC2449	TCZBOEB	X'A7'	2 3 7 11 18 22 24

Table 54. CICS messages associated with VTAM errors (continued)

Message	Symbolic label	Error code	Action flags set
DFHZC2450	TCZSSXAR	X'83'	None
DFHZC2451	TCZSRCCI	X'CC'	2 3 9 10 11
DFHZC2452	TCZCXE2	X'D5'	3 7 9 10 11 18 24
DFHZC2453	TCZCXRR	X'D4'	1 2 3 9 10
DFHZC2454	TCZSRCCX	X'CD'	2 3 9 10 11
DFHZC2455	TCZRACET	X'93'	2 3 9 10 11
DFHZC2456	TCZSRCDE	X'44'	2 3 7 9 10 11 24
DFHZC2457	TCZRNCH	X'D8'	2 3 7 9 10 11 24
DFHZC2458	TCZPXE2	X'DD'	None
DFHZC2459	TCZSDSE7	X'99'	3 9 11
DFHZC2463	TCZDMPD	X'D3'	None
DFHZC2467	TCZLEXCI	X'88'	2 3 7 9 10 11 23 24
DFHZC2468	TCZLEXUS	X'89'	2 3 7 9 10 11 24
DFHZC2469	TCZYX43	X'D9'	2 3 9 10 11
DFHZC2469	TCZEXRVT	X'F2'	2 3 9 10 11
DFHZC2470	TCZSXC3	X'DA'	7 9 10 11 24
DFHZC2471	TCZFMHLE	X'A8'	2 3 4 7 10 11 22 24
DFHZC2472	TCZRACRF	X'A9'	11
DFHZC2473	TCZSDSE9	X'AA'	3 9 11
DFHZC2485	TCZCNCL	X'E3'	3 9 10 11
DFHZC2486	TCZRACNL	X'9B'	3
DFHZC2487	TCZLGNA	X'76'	3
DFHZC2488	TCZDMRY	X'77'	None
DFHZC2489	TCZINCPY	X'40'	3 9 11
DFHZC2490	TCZTOLRQ	X'41'	2 3 7 9 10 11 15 24
DFHZC2497	TCZUNPRT	X'42'	None
DFHZC2498	TCZICPUT	X'4B'	None
DFHZC3400	TCZCHMX	X'45'	3 10 11 22
DFHZC3402	TCZOCIR	X'46'	3 9 10 11
DFHZC3409	TCZUNEGR	X'85'	2 3 7 9 10 11 23 24
DFHZC3410	TCZINIIR	X'BC'	2 3 9 10 11
DFHZC3416	TCZDMSLE	X'E8'	2 3
DFHZC3417	TCZSDRE3	X'50'	3 7 9 10 11 24
DFHZC3418	TCZBDPRI	X'51'	3 7 9 10 11 24
DFHZC3419	TCZBDUAC	X'52'	2 3 5 7
DFHZC3420	TCZBDTOS	X'53'	7 20
DFHZC3421	TCZSBIRV	X'5A'	7 20
DFHZC3422	TCZNSP01	X'5B'	2 3 7 9 10 11 18 24
DFHZC3424	TCZNSP02	X'5C'	7 9 10 11 15 24
DFHZC3428	TCZSTRMH	X'EB'	3

Table 54. CICS messages associated with VTAM errors (continued)

Message	Symbolic label	Error code	Action flags set
DFHZC3429	TCZSTRMM	X'EC'	2 3 7
DFHZC3430	TCZSTON	X'ED'	2 3
DFHZC3431	TCZSTIN	X'EF'	2 3
DFHZC3432	TCZSTLER	X'EA'	2 3
DFHZC3433	TCZERMGR	X'58'	7
DFHZC3434	TCZUNBIS	X'54'	2 3 7 9 10 11 24
DFHZC3440	TCZEMWBK	X'55'	None
DFHZC3441	TCZVTAMO	X'63'	None
DFHZC3442	TCZVTAMK	X'67'	None
DFHZC3443	TCZVTAMA	X'64'	None
DFHZC3444	TCZTIOAE	X'6A'	1 2 3 7 9 10 11 24
DFHZC3452	TCZSIGR	X'66'	None
DFHZC3454	TCZBRUAC	X'5E'	2 3 5 7 18 24
DFHZC3455	TCZBDSQP	X'5F'	2 3 5 7 18 24
DFHZC3461	TCZOPSIN	X'48'	7 , 8
DFHZC3462	TCZCLSIN	X'49'	7
DFHZC3463	TCZOPACB	X'4A'	None
DFHZC3464	TCZRELIS	X'57'	7 20
DFHZC3465	TCZRSPER	X'9D'	1 2 3 7 9 10 11 23
DFHZC3466	TCZSEXOS	X'69'	7 20 23
DFHZC3468	TCZCLRRV	X'70'	7 9 10 11 15 24
DFHZC3469	TCZVHOLD	X'CE'	7 9 10 11 24
DFHZC3470	TCZXSHRA	X'37'	9 10 11 24
DFHZC3470	TCZLUERR	X'AB'	7 9 10 11 24
DFHZC3471	TCZVRNOP	X'CF'	7 9 10 11 24
DFHZC3472	TCZDEVND	X'9E'	None
DFHZC3473	TCZSL SRL	X'4D'	None
DFHZC3474	TCZVRDAC	X'AC'	7 9 10 11 24
DFHZC3475	TCZNRLUF	X'AD'	7 9 10 11 24
DFHZC3476	TCZRCLUF	X'AE'	7 9 10 11 24
DFHZC3477	TCZCLEAN	X'AF'	7 9 10 11 24
DFHZC3479	TCZUNBFE	X'4E'	2 3 7 9 10 11 24
DFHZC3480	TCZNOISC	X'A0'	7 23 24
DFHZC3481	TCZDSPCL	X'4C'	2 3 7 9 10 11 24
DFHZC3482	TCZDMGF	X'DF'	None
DFHZC3484	TCZPASSD	X'C6'	None
DFHZC3485	TCZPSPRE	X'C7'	7 24
DFHZC3486	TCZLUINP	X'C2'	7 24
DFHZC3487	TCZNPSAU	X'C9'	7 24
DFHZC3488	TCZXUVAR	X'3C'	2 3 7 9 10 11 24

Table 54. CICS messages associated with VTAM errors (continued)

Message	Symbolic label	Error code	Action flags set
DFH3C3489	TCZLUINH	X'C8'	7 18 24
DFH3C3490	TCZCPFAL	X'C3'	7 24
DFH3C3491	TCZEXRO	X'B0'	7 15 24
DFH3C3492	TCZDMIT	X'16'	None
DFH3C3495	TCZNOTNA	X'6B'	7 24
DFH3C3499	TCZDWEFG	X'C0'	None
DFH3C4902	TCZLUCF1	X'21'	3 7 9 10 11 24
DFH3C4903	TCZLUCF2	X'22'	3 7 9 10 11 24
DFH3C4904	TCZF5MBE	X'23'	3 7 10 11 9 24
DFH3C4905	TCZF5MCS	X'24'	3 7 10 11 9 24
DFH3C4906	TCZF5MCR	X'25'	3 7 10 11 9 24
DFH3C4907	TCZSDLER	X'26'	3 7 10 11 9 24
DFH3C4909	TCZRVLER	X'28'	3 7 10 11 9 24
DFH3C4910	TCZRVLRB	X'29'	3 7 10 11 9 24
DFH3C4911	TCZRLPEX	X'2A'	2 3 7 9 10 11 24
DFH3C4912	TCZRLPBD	X'2B'	2 3 7 9 10 11 24
DFH3C4913	TCZRLPDR	X'2C'	2 3 7 9 10 11 24
DFH3C4914	TCZRLPIL	X'2D'	2 3 7 9 10 11 24
DFH3C4915	TCZRLPEC	X'2E'	2 3 7 9 10 11 24
DFH3C4916	TCZRLPRR	X'2F'	2 3 7 9 10 11 24
DFH3C4917	TCZRLPIF	X'30'	2 3 7 9 10 11 24
DFH3C4918	TCZRLPIR	X'31'	2 3 7 9 10 11 24
DFH3C4919	TCZIVIND	X'33'	2 3 7 9 10 11 24
DFH3C4920	TCZIVDAT	X'34'	2 3 7 9 10 11 24
DFH3C4922	TCZRLXCL	X'32'	7 20
DFH3C4924	TCZNSEED	X'B6'	2 3 5 7 24
DFH3C4925	TCZASINC	X'B7'	2 3 5 7 24
DFH3C4926	TCZEVBAD	X'B8'	2 3 5 7 24
DFH3C4927	TCZFMH12	X'B9'	2 3 5 7 24
DFH3C4928	TCZDESGM	X'BD'	7 24
DFH3C4929	TCZBDBND	X'B3'	2 3 5 7 24
DFH3C4930	TCZRTMT	X'35'	2 3 7 9 10 11 24
DFH3C4931	TCZBDMOD	X'F1'	7 18 24
DFH3C4932	TCZICTYP	X'F3'	2 3 7 24
DFH3C4933	TCZIDBA	X'F4'	2 3 24
DFH3C4934	TCZISYNL	X'F5'	2 3 7 24
DFH3C4935	TCZIUOW	X'F6'	2 3 7 24
DFH3C4936	TCZIFMHL	X'F7'	2 3 7 24
DFH3C4937	TCZLUSRR	X'8A'	2 3 5 7 24
DFH3C4938	TCZLUSRF	X'8B'	2 3 5 7 24

Table 54. CICS messages associated with VTAM errors (continued)

Message	Symbolic label	Error code	Action flags set
DFHZA4939	TCZLUPUN	X'8C'	2 3 5 7 24
DFHZA4940	TCZLUSKN	X'8F'	2 3 5 7 24
DFHZA4941	TCZLUPLK	X'8D'	2 3 5 7 24
DFHZA4942	TCZLUPEX	X'8E'	2 3 5 7 24
DFHZA4943	TCZFMRB	X'F8'	3 7 9 10 11 24
DFHZA4944	TCZBFAIL	X'BE'	2 3 5 7 24
DFHZA4945	TCZPRGE	X'A2'	3 7 9 10 11 24
DFHZA4946	TCZINVAT	X'F9'	2 3 7 24
DFHZA4947	TCZLUSEC	X'FA'	2 3 7 24
DFHZA4949	TCZRABUS	X'7D'	2 3 7 9 10 11 24
DFHZA6590	TCZXRST	X'3F'	None
DFHZA6591	TCZXERR	X'3E'	7 9 10 11 15 24
DFHZA6593	TCZXSBC	X'3B'	None
DFHZA6594	TCZXSHR	X'3A'	7 24
DFHZA6595	TCZXSABN	X'39'	2 3 5 7 24
DFHZA6596	TCZXSAS	X'38'	2 3 7 15 24
DFHZA6598	TCZXRFS	X'56'	None

## DFHZNAC—default actions for system sense codes

Table 55 shows the message issued and action flags set by DFHZNAC for each inbound system sense code received. See the *CICS Messages and Codes* manual for a description of the conditions that correspond to the system sense codes. The figures in the “**Action flags set**” column are translated into bit settings and explained in Table 56 on page 868.

Table 55. Messages issued and flags set by DFHZNAC for specific sense codes

Sense code	Message	Action flags set
X'0001' <sup>1</sup>	DFHZA3401	2
X'0002' <sup>1</sup>	DFHZA3415	2, 3, 10, 11
X'0003' <sup>1</sup>	DFHZA3449	None
X'0004' <sup>1</sup>	DFHZA3450	None
X'0007' <sup>1</sup>	DFHZA3451	None <sup>2</sup>
X'00FF'	DFHZA3446	2, 3, 7, 9, 10, 11, 23, 24
X'0801'	DFHZA2476	3, 9, 10, 11
X'0802'	DFHZA2461	None
X'0806'	DFHZA3426	None
X'0807'	DFHZA3411	None
X'080B'	DFHZA2462	2, 3, 7, 9, 10, 11, 15, 24
X'080E'	DFHZA3448	23
X'080F'	DFHZA3436	9, 10, 11



Table 55. Messages issued and flags set by DFHZNAC for specific sense codes (continued)

Sense code	Message	Action flags set
X'0811'	DFHZC2464	9, 10, 11
X'0812'	DFHZC2465	2, 3
X'081B'	DFHZC2483	2, 3 <sup>3</sup>
X'081C'	DFHZC2466	2, 3, 9, 10, 11
X'0824'	DFHZC2475	3, 9, 10, 11
X'0825'	DFHZC2484	2, 3, 9, 10, 11
X'0826'	DFHZC3423	2, 3, 9, 10, 11
X'0827'	DFHZC2480	3
X'0829'	DFHZC3407	1, 2, 3, 7,10, 11, 24
X'082A'	None <sup>4</sup>	9
X'082B'	DFHZC3408	2, 3, 10, 11, 13
X'082D'	DFHZC3413	None
X'082E'	DFHZC3412	None
X'082F'	DFHZC3414	2, 3, 9, 10, 11
X'0831'	DFHZC3438	None
X'0833'	DFHZC3427	None
X'0847'	DFHZC3439	None
X'084A'	None <sup>5</sup>	None
X'084C'	DFHZC3467	9, 10, 11
X'0860'	DFHZC3459	None
X'0863'	DFHZC3460	9, 10, 11
X'0864'	DFHZC2475	3, 9, 10, 11
X'0865'	DFHZC2465	3, 9, 10, 11
X'0866'	DFHZC2475	3, 9, 10, 11
X'0867'	None <sup>6</sup>	9, 10, 11
X'0868'	DFHZC3456	2, 9, 10, 11
X'0869'	DFHZC3457	2, 9, 10, 11
X'08FF'	DFHZC3447	2, 3, 7, 9, 10, 11, 24
X'1000'	DFHZC3494	2, 3, 9, 10, 11
X'1001'	DFHZC2481	2, 3, 9, 10, 11, 14
X'1002'	DFHZC2481	2, 3, 9, 10, 11, 14
X'1003'	DFHZC2479	2, 3, 9, 10, 11, 14
X'1005'	DFHZC3406	2, 3, 4, 9, 10, 11, 14
X'1008'	DFHZC2478	None
X'1009'	DFHZC3458	2, 9, 10, 11
X'10FF'	DFHZC3446	2, 3, 7, 9, 10, 11, 23, 24
X'2003'	DFHZC3405	2, 3, 7, 9, 10, 11, 15, 24
X'20FF'	DFHZC3445	2, 3, 7, 9, 10, 11, 23, 24
X'400B'	DFHZC2477	1, 3, 11

Table 55. Messages issued and flags set by DFHZNAC for specific sense codes (continued)

Sense code	Message	Action flags set
X'40FF'	DFHZC3453	2, 3, 7, 9, 10, 11, 23, 24
X'8000'	DFHZC3435	2, 3, 7, 9, 10, 11, 18, 24
X'8005'	DFHZC3435	2, 3, 7, 9, 10, 11, 18, 24
X'80FF'	DFHZC3435	2, 3, 7, 9, 10, 11, 18, 23, 24
X'FFFF'	DFHZC2460	2, 3, 7, 9, 10, 11, 23, 24

**Note:**

1. The system sense code is in the form of an LUSTATUS command code.
2. No action flags are set if a task is attached or if outstanding operations are to complete. Otherwise, flag 21 is set.
3. Action flags 2 and 3 are set for negative response received for a SEND that requested a definite response.
4. Presentation space error.
5. Presentation error on read. Display buffer alteration, due to operator intervention, detected on a READ command to a compatibility-mode logical unit.
6. Function abend received from a device. A negative response to a chain was sent, but purged.

---

## Action flag settings and meanings

Table 56 shows the “action flags” that can be set by DFHZNAC in the communication area passed to DFHZNEP. The flags set by DFHZNAC represent the default actions that will be taken if the settings are not changed by DFHZNEP.

The figures in the “**Flag**” column refer to those in columns 3 of Table 53 on page 855 and Table 55 on page 866.

Table 56. Meanings of action flags set by DFHZNAC

Flag	Field	Bit mask	Hex bit setting	Action
1	TWAOPT1	1... ....	X'80'	Print action flags
2		.1.. ....	X'40'	Print VTAM RPL
3		..1. ....	X'20'	Print TCTTE
4		...1 ....	X'10'	Print TIOA
5		.... 1...	X'08'	Print BIND area
6		.... .1..	X'04'	System dump if no task attached
7		.... ..1.	X'02'	Print network-qualified name (NQNAME)
8		.... ...1	X'01'	Print TN3270 IP address (TNADDR)
9	TWAOPT2	1... ....	X'80'	Abort any send for this terminal
10		.1.. ....	X'40'	Abort any receive for this terminal

Table 56. Meanings of action flags set by DFHZNAC (continued)

Flag	Field	Bit mask	Hex bit setting	Action
11		..1. ....	X'20'	Abend any task attached to TCTTE
12		...1 ....	X'10'	Cancel any task attached to TCTTE
13		.... 1...	X'08'	Good Morning message to be sent
14		.... .1..	X'04'	Purge any BMS pages for this TCTTE
15		.... ..1.	X'02'	SIMLOGON required
17	TWAOPT3	1... ....	X'80'	Set INTLOG now allowed
18		.1.. ....	X'40'	Set no internal general logons
20		...1 ....	X'10'	Normal CLSDST (no reset allowed)
21		.... 1...	X'08'	Normal CLSDST (reset allowed)
22		.... .1..	X'04'	Send negative response
23		.... ..1.	X'02'	AOS - keep node out of service
24		.... ...1	X'01'	CLSDST node



---

## Appendix C. Analyzing CICS restart information

You can programmatically determine the type of CICS shutdown that occurred and whether it is safe to override the next restart type and perform a cold restart of the CICS system.

DFHRMUTL provides the SET\_AUTO\_START keywords to allow a CICS system to be auto-restarted with a given override. This can include AUTOCOLD, to make CICS perform a cold start. Care should be taken when performing such a change. A CICS system that was shutdown warm, and which had no indoubt, commit-failed, or backout-failed units of work (UOWs) keypointed at that time, can be restarted cold without loss of data integrity. However, if the system was not shutdown in a controlled manner, or there are such units of work recorded on the system log, a cold restart should not be performed, because system data integrity can be compromised.

To help you determine whether a cold start of the region system is appropriate or not, CICS provides the following information:

1. The following DFHRMUTL summary information:
  - The next CICS start type found on the global catalog, DFHGCD.
  - If the next CICS start type is warm, counts of those units of work that were in an indoubt, commit-failed, or backout-failed state when CICS was shut down.
2. A CICS global catalog record with the following VSAM KSDS key:

```
X'00000011C4C6C8D9D4C4D440C4C6C8D9D4C4D46DD9C5E2E3C1D9E340'
```

This record contains three fullword counts following the key. These are:

- a. The number of indoubt UOWs
- b. The number of commit-failed UOWs
- c. The number of backout-failed UOWs

If any of these counts contains a number greater than zero, recovery information for these units of work is present on the CICS system log. In this case, a modification of the CICS autostart override record to AUTOCOLD is not appropriate, because system data integrity would be jeopardized.

CICS deletes this global catalog record during restart, and writes it during a controlled shutdown. Therefore presence or absence of the record on the catalog indicates whether the CICS system was previously shutdown warmly (that is, by the use of CEMT PERFORM SHUTDOWN) or not. If the record exists on the global catalog, and the three count fields are zero, it is safe to use DFHRMUTL to modify the autostart override record to AUTOCOLD.

Here is an example of this record, showing the presence of one indoubt unit of work at the time CICS was shutdown:

```
KEY OF RECORD -
00000011C4C6C8D9D4C4D440C4C6C8D9D4C4D46DD9C5E2E3C1D9E340

00000011C4C6C8D9D4C4D440C4C6C8D9D4C4D46DD9C5E2E3C1D9E3400000001
0000000000000000
```

You can use the DFHRMRED Assembler DSECT in a batch program to map the global catalog record. DFHRMRED is found in the CICSTS32.CICS.SDFHMAC library.

For more information about the DFHRMUTL utility, see the *CICS Operations and Utilities Guide*.



---

## Appendix D. Using the transient data write-to-terminal program (DFH\$TDWT)

DFH\$TDWT is a sample program that sends transient data messages to a terminal or printer. You can use it to send messages from a single transient data queue, or from several queues, to one terminal.

In the definition for the transient data queue, you can specify that particular categories of message (for example, those from the abnormal condition program and signon and sign-off messages) should be sent to destinations defined as indirect. If these indirect destinations are defined so that they refer to the same intrapartition queue with a transaction identifier and a trigger level of 1, the receipt of a single message in any of the specified categories causes the transaction to be started. The program thus invoked displays or prints the message. The transaction that invokes the DFH\$TDWT sample program is TDWT.

To use the sample program, your CICS system must include automatic transaction initiation and an intrapartition transient data set. The source code for the DFH\$TDWT sample program is provided in CICSTS32.CICS.SDFHSAMP, and the object code is provided in CICSTS32.CICS.SDFHLOAD.

For detailed information about defining transient data queues, see the *CICS Resource Definition Guide*.

---

### DFH\$TDWT—resource definitions required

To use the DFH\$TDWT sample program as supplied, you need the following resource definitions installed on your CICS region:

- A program definition for the DFH\$TDWT program
- A transaction definition for the TDWT transaction
- A terminal definition for the L86P terminal
- A definition for the intrapartition queue, L86P
- Definitions for the indirect intrapartition queues pointing to the L86P queue.

These required resource definitions are provided in the CICS-supplied group, DFH\$UTIL. Add DFH\$UTIL to your CICS startup group list.

However, you must define the other resources. Add a terminal definition for the L86P terminal to the CSD, and install it in your CICS region.





---

## Appendix E. Uppercase translation

This appendix describes how to translate lower- and mixed-case characters to uppercase. “Translating national characters to uppercase” describes how to translate national characters that CICS cannot handle by standard means. “Translating TS data sharing messages to uppercase” on page 876 describes how to translate operator messages produced by CICS temporary storage data sharing.

---

### Translating national characters to uppercase

In CICS, translation of terminal user-input to uppercase characters can be done either by using the UCTRAN option on the PROFILE and TYPETERM definitions, or by using the EXEC CICS SET TERMINAL(termid) UCTRANST command.

However, some languages have characters which are not part of the set of EBCDIC characters translated by UCTRAN, and so are never translated to uppercase, regardless of what you have specified on your resource definitions. To translate these national characters, you have two options:

- Use the XZCIN exit
- Create a new terminal control table (TCT), based on your current TCT (or on the dummy TCT, DFHTCTDY, if you have TCT=NO specified in the SIT), and modify the translation table in it.

Whichever method you use, the *Character Data Representation Architecture Level 1 - Registry* manual, SC09-1391-00, is a useful reference for information on code pages.

#### Using the XZCIN exit

XZCIN is described on page 121. To use it for uppercase translation, you must supply your own translation routine, which is then invoked when terminal input occurs.

#### Using DFHTCTxx

To translate national characters which are not handled by UCTRAN, you can modify the translation table in the terminal control table.

If you use RDO for all your terminals and have TCT=NO specified in your SIT or its overrides, CICS uses the dummy TCT, DFHTCTDY, to create control blocks for RDO-defined and autoinstalled terminals. *It is not recommended that you modify DFHTCTDY directly.* Instead, take a copy of the DFHTCTDY source file, save it under a new name, and modify the copy. The steps you need to follow are:

1. Take a copy of the DFHTCTDY assembler source file. CICS provides this in the CICSTS32.CICS.SDFHSAMP library.
2. Modify the translation table in the source file, as shown in Figure 133 on page 876.
3. Save the source file as DFHTCTxx, where 'xx' is any 2-character suffix other than 'DY'.
4. Use the CICS-supplied DFHAUPLE job to assemble, define to SMP/E, and linkedit the new table.
5. Specify the 2-character suffix of your new TCT on the SIT TCT parameter.
6. Restart CICS, so that the new TCT takes effect.

**Note:** If you are already using a customized TCT rather than DFHTCTDY (that is, something other than 'NO' or 'DY' is specified on the SIT TCT parameter), you must add your translation code to the TCT you are using.

Figure 133 shows a suggested way to code the assembler source statements to translate your national characters.

```

MACRO
NATLANG
DFHUCTRT CSECT          Resume UCTRAN table CSECT
.*
.* This example translates lowercase 'a' ( EBCDIC X'81') to
.* uppercase 'A' (EBCDIC X'C1') for a US code page.
.*
      ORG TCZUCTAB+X'81'      Reset the counter to the
                              character to be translated.
      DC  X'C1'              Declare the replacement
                              character as a constant.
.*
.* Repeat the above two statements for each extra character you wish
.* to be translated.
.*
      ORG ,                  Reset the location counter
&SYSLOC LOCTR              Resume previous location counter
      MEND                  End of macro definition
      DFHTCT TYPE=INITIAL,SUFFIX=xx,          *
          MIGRATE=COMPLETE,                  *
          ACCMETH=(VTAM),                    *
          DUMMY=DUMMY
      NATLANG                  Execute NATLANG
      DFHTCT TYPE=FINAL
      END DFHTCTBA

```

Figure 133. Suggested coding for national language character translation

---

## Translating TS data sharing messages to uppercase

CICS temporary storage (TS) data sharing uses AXM services to write operator messages. These messages are in mixed-case English; table AXMMSTAB is used to remove unprintable characters. If necessary, you can modify AXMMSTAB to convert the messages to uppercase English.

The modules that use AXM message services are AXMSI, AXMSC, and DFHXQMN. AXMSI and AXMSC are both in a linklist library; DFHXQMN is in the CICS authorized library. To convert TS data sharing messages to uppercase, modify the copy of AXMMSTAB used by each of these modules by using SPZAP with the following input (for each module):

```

NAME modulename AXMMSTAB
VER 0081 818283848586878889
VER 0091 919293949596979899
VER 00A2 A2A3A4A5A6A7A8A9
REP 0081 C1C2C3C4C5C6C7C8C9
REP 0091 D1D2D3D4D5D6D7D8D9
REP 00A2 E2E3E4E5E6E7E8E9

```

---

## Appendix F. The example program for the XTSEREQ global user exit, DFH\$XTSE

This appendix lists the example global user exit program, DFH\$XTSE. The example shows you how to:

- Use EXEC CICS commands in a global user exit program
- Use EXEC CICS commands and XPI calls in the same exit program
- Modify the command parameter list in EXEC interface exits such as XTSEREQ, XICEREQ, and XFCREQ
- Modify Temporary Storage (TS) requests.

```
*****
*
* MODULE NAME = DFH$XTSE
*
* FUNCTION =
* Example global user exit program to run at the XTSEREQ and
* XTSEREQC exits.
*
* DESCRIPTION =
* The program gives examples of:
* 1) Coding Exec Interface global user exits, showing how to
* modify and add parameters to the Command Parameter List.
* 2) Issuing a mixture of EXEC CICS API and XPI calls within
* the same global user exit program.
* 3) Modifying Temporary Storage requests, by renaming the queue
* name and allowing the SYSID to be added so that the request
* is routed to a queue-owning region (QOR).
*
* -----
* NOTE that this program is only intended to DEMONSTRATE the use
* of the TS request user exit XTSEREQ, and to show the sort of
* information which can be obtained from the exit parameter list.
* IT SHOULD BE TAILORED BEFORE BEING USED IN A PRODUCTION ENVIRONMENT.
* -----
*
* NOTES =
* The important notes to remember when coding similar global user
* exits are:
*
* 1) If the exit program modifies the Command Parameter List, you
* MUST ensure that the storage used for additional fields such
* as the SYSID is non-volatile. Here are examples of storage
* that is safe:
* a) Shared storage obtained by GETMAIN. This should be
* obtained in the Request exit, and freed in the Request
* Complete exit.. The shared storage address can be passed
* using the 4-byte token in the DFHUEPAR parameter list.
* b) Shared global work area storage.
* c) Storage obtained by using the LOAD HOLD option.
* d) TCTUA or CWA storage.
```

Figure 134. Example exit program for the XTSEREQ exit (part 1)

```

*
* It is not safe to use the following storage:
* Program storage (DFHEISTG) since this is freed as soon
* as the exit program returns control to CICS.
*
*
* 2) When adding or removing a field in the command parameter list,
* you must remember:
* a) To set/clear the field's existence bit in the EID
* b) To set/clear the appropriate address in the Addr_List
* c) To set the hi-order bit in the LAST address in the
* Addr_List.
*
*
* 3) If you are planning to use the CICS API in the exit, you
* must:
* a) Use the DFHEIENT macro to control module entry.
* b) Use the DFHEIRET macro to return control to CICS. However,
* the exit return code MUST be set in Register 15.
* c) Issue an ADDRESS EIB command before issuing any EXEC CICS
* commands.
*
*
* 4) If you are planning to use the API and XPI in the same
* global user exit program, take care to ensure that Register
* 13 points to the kernel stack entry (UEPSTACK) for XPI calls,
* and is restored for API calls if necessary.
*
*
*****
EJECT ,
-----*
*
* Copybook and DSECTS required by the exit program
*
*-----*
DFHUEXIT TYPE=EP,ID=(XTSEREQ,XTSEREQC)
DFHUEXIT TYPE=XPIENV Exit programming interface (XPI)
COPY DFHTRPTY Trace XPI definitions
COPY DFHTSUED Command Level Plist definitions
*
*-----*
* The following DSECT maps the shared storage obtained by the
* EXEC CICS GETMAIN API call. This storage is used to store the
* modified SYSID and/or TS QNAME that is passed to CICS on return
* from the exit program.
*-----*
SHARED_STORAGE DSECT
SHARED_EYECATCHER DS CL16
SHARED_NAME DS CL8
SHARED_SYSID DS CL4
*

```

Figure 135. Example exit program for the XTSEREQ exit (part 2)

```

*-----*
* The TS Routing table is made up of a set of entries. Each entry *
* can be mapped by the TABLE_ENTRY DSECT *
*-----*
TABLE_ENTRY DSECT
ENTRY_NAME DS CL8
NEW_NAME DS CL8
NEW_SYSID DS CL4
ENTRY_ACTION DS XL1
FILLER DS CL3
*
*-----*
* The following definitions are for program working storage. *
*-----*
DFHEISTG DSECT
RETCODE DS XL4 Program Return Code
TR_ERROR_N DS X Error Number for Trace Entry
RESP DS X API Response
EJECT ,
*****
* PROGRAM REGISTER USAGE : *
* R0 - Work Register *
* R1 - Points to DFHUEPAR plist on entry *
* Work Register *
* R2 - DFHUEPAR parameter List *
* R3 - Code Base Register *
* R4 - <unused> *
* R5 - <unused> *
* R6 - Subroutine Linkage Register *
* R7 - Address of TS Queue Name from Command Plist *
* R8 - Command Parameter list UEPCPLPS *
* R9 - Address of Table_Entry in TS_Routing_Table *
* R10- <unused> *
* R11- EIB Register *
* R12- Work Register *
* R13- DFHEISTG for API calls *
* Kernel Stack for XPI calls *
* R14- Work Register *
* R15- Work Register *
*****
EJECT ,
*****
* DFH$XTSE - Main Routine *
* This is the entry point for the exit program. Control is passed *
* to the TS_REQUEST or TS_REQUEST_COMPLETE routines depending *
* on whether the exit was invoked at the XTSEREQ or XTSEREQC exit *
* points. *
*

```

Figure 136. Example exit program for the XTSEREQ exit (part 3)

```

* Registers:
* R1 = UEPAR plist (set on entry)
*   = Work register
* R2 = UEPAR plist
* R3 = Program base register (set by DFHEIENT)
* R6 = Linkage register
* R11= EIB register
* R13= EISTG register (set by DFHEIENT)
* R15= Work register
*     User Exit Return Code
*
* Logic:
* DFH$XTSE:
*   Exec Interface Entry
*   Address DFHUEPAR plist
*   Set OK Return Code
*   Address the EIB
*   Trace entry
*   Select Exitid
*     When(XTSEREQ) then call TS_Request
*     When(XTSEREQC) then call TS_Request_Complete
*     Otherwise call Error(Invalid_Exit)
*   End Select
*   Trace exit
*   Set Exit return code
*   Return
*****
DFH$XTSE DFHEIENT
DFH$XTSE AMODE 31
DFH$XTSE RMODE ANY
      LR   R2,R1           DFHUEPAR plist provided by caller
      USING DFHUEPAR,R2   Use R2 to address UEPAR PLIST
*
      LA   R15,UERCNORM    Set OK Response
      ST   R15,RETCODE     in working storage
*
      EXEC CICS ADDRESS EIB(R11)
      USING DFHEIBLK,R11
*
      BAL  R6,TRACE_ENTRY  Trace program entry
*
      L    R1,UEPEXN        Address of the 1 byte Exit Id
      CLI  0(R1),XTSEREQ    Is this XTSEREQ exit?
      BE   TS_REQUEST       ..Yes Branch to routine
      CLI  0(R1),XTSEREQC  Is this XTSEREQC exit?
      BE   TS_REQUEST_COMPLETE .. Yes Branch to routine
      B    ERROR1           Otherwise Branch to error routine
*
RETURN DS   0H            Return point
      BAL  R6,TRACE_EXIT  Trace program exit
*
      L    R15,RETCODE     Fetch return code
      DFHEIRET RCREG=15    Return to CICS
      EJECT ,

```

Figure 137. Example exit program for the XTSEREQ exit (part 4)

```

*=====*
* TS_REQUEST - Invoked at XTSEREQ exit point *
* Determine the TS Queue Name and scan the TS_Routing_Table for *
* a match. If an entry exists in the table, then check the action *
* field and call the ROUTE_REQUEST or LOCAL_REQUEST routines. *
* *
* The TS_Routing_Table is made up of entries with the following *
* structure: *
* *
* TABLE_ENTRY: *
* ----- *
* | Entry_Name | New_Name | QOR_Sysid | Action | *filler* | *
* | Char 8 | Char 8 | Char 4 | Bin 1 | Char 3 | *
* ----- *
* Last Entry is indicated by special TS_Queue Name *
* *
* Registers: *
* R1 = Work register *
* R7 = Set to the TS Queue Name *
* R8 = Command Parameter List (CLPS) *
* R9 = Points to the next entry in the TS_Routing_Table *
* R15= Work register *
* *
* Logic: *
* TS_Request: *
* If called recursively then *
* call Error(Recursive_Call1) *
* Else *
* If the Command GROUP code is not a TS request then *
* call Error(Invalid_Group_Code1) *
* Else *
* Clear the UEPTQTOK *
* Address the Command Plist UEPCPLS *
* Fetch tsq_name *
* Fetch start of TS_Routing_Table *
* Check_Next_Entry: *
* Get the next table entry *
* Select (entry_name) *
* When (last_entry) call Entry_Not_Found *
* When (tsq_name) *
* Select (entry_action) *
* When (Route) call Route_Request *
* When (Local) call Local_Request *
* Otherwise call Error(Invalid_Table_Action) *
* End Select *
* Otherwise *
* Goto Check_Next_Entry *
* End Select *
* End If *
* End If *
* Return *

```

Figure 138. Example exit program for the XTSEREQ exit (part 5)

```

*=====
TS_REQUEST DS 0H
*   Check for possible recursion
    L   R1,UEPRECUR      Address of recursive count
    LH  R1,0(R1)         Fetch count
    LTR R1,R1            Has exit been invoked recursively?
    BNZ ERROR2          ..Yes Branch to error routine
*
*   Extract pointer to the EID and TS queue name from CLPS
    L   R8,UEPCLPS      Fetch address of Command Plist
    USING TS_ADDR_LIST,R8 Use R8 to address CLPS
    L   R1,TS_ADDR0     Address the EID..
    L   R7,TS_ADDR1     Fetch address of TS QUEUE
    DROP R8             Drop addressability to CLPS
*
*   Check that the Command GROUP code corresponds to a TS request
    USING TS_EID,R1     ..with Register 1
    CLI TS_GROUP,TS_TEMPSTOR_GROUP Is this a TS request?
    BNE ERROR3         ..No Branch to error routine
    DROP R1            Drop addressability to EID
*
*   Clear the TS Request token
    L   R1,UEPTQOK      Fetch address of token
    XC  0(4,R1),0(R1)   Clear Token for XTSEREQC
*
*-----*
* Start scan of TS_Routing Table *
*-----*
    LA  R9,TS_ROUTING_TABLE Fetch address of routing table
    USING TABLE_ENTRY,R9   Address entries from R9
*
CHECK_NEXT_ENTRY DS 0H
    CLC ENTRY_NAME,ENTRY_NAME_LAST Is this the last entry
    BE  ENTRY_NOT_FOUND ..Yes Take default routing action
    CLC ENTRY_NAME,0(R7) Is this the wanted TS queue name?
    BE  ENTRY_FOUND ..Yes Check for the action required
    LA  R9,24(R9) Point to next entry
    B   CHECK_NEXT_ENTRY Start search again
*
ENTRY_FOUND DS 0H
    CLI ENTRY_ACTION,ROUTE Is the action to route request?
    BE  ROUTE_REQUEST ..Yes Branch to Route routine
    CLI ENTRY_ACTION,LOCAL Is the action to rename queue?
    BE  LOCAL_REQUEST ..Yes Branch to Local routine
    B   ERROR4 Otherwise Branch to error routine
    DROP R9 Drop addressability to Entry
    EJECT ,
*

```

Figure 139. Example exit program for the XTSEREQ exit (part 6)



```

*=====*
* TS_REQUEST_COMPLETE - Invoked at XTSEREQC exit point *
*   Free any shared storage that was acquired during previous *
*   invocation at XTSEREQ. *
* *
* Registers: *
*   R1 = Work register *
*   R6 = Linkage register *
*   R8 = Command Parameter List (CLPS) *
* *
* Logic: *
*   TS_Request_Complete: *
*   If called recursively then *
*     call Error(Recursive_Call2) *
*   Else *
*     If the Command GROUP code is not a TS request then *
*       call Error(Invalid_Group_Code2) *
*     Else *
*       If UEPTQOK->token ^= 0 then Call Freemain_Shared_Plist *
*     End If *
*   End If *
*   Return *
*=====*
TS_REQUEST_COMPLETE DS 0H
*   Check for possible recursion
*   L   R1,UEPRECUR      Address of recursive count
*   LH  R1,0(R1)        Fetch count
*   LTR R1,R1           Has exit been invoked recursively?
*   BNZ ERROR5         ..Yes Branch to error routine
*
*   Check that the Command GROUP code corresponds to a TS request
*   L   R8,UEPCLPS      Fetch address of Command Plist
*   USING TS_ADDR_LIST,R8 Use R8 to address CLPS
*   L   R1,TS_ADDR0     Address the EID..
*   USING TS_EID,R1     ..with Register 1
*   CLI TS_GROUP,TS_TEMPSTOR_GROUP Is this a TS request?
*   BNE ERROR6         ..No Branch to error routine
*   DROP R1            Drop addressability to EID
*   DROP R8            Drop addressability to CLPS
*
*   L   R1,UEPTQOK      Fetch address of Token
*   L   R1,0(R1)        Fetch actual token
*   LTR R1,R1           Did XTSEREQ GETMAIN any storage?
*   BZ  RETURN          ..No Return to caller
*   BAL R6,FREEMAIN_SHARED ..Yes Issue FREEMAIN
*   B   RETURN          Return to caller
*   EJECT ,
*
*

```

Figure 140. Example exit program for the XTSEREQ exit (part 7)

```

*=====*
* LOCAL_REQUEST: Process Local TS Queues *
* An entry has been found in the TS_Routing Table for this TS *
* Queue Name. If required, rename the TS Queue Name, but do not *
* modify the SYSID. *
* *
* Registers: *
* R1 = Work register *
* R6 = Link Register *
* R7 = Address of current Queue name (Set on entry) *
* R8 = Command Parameter List (CLPS) *
* R9 = Address of table entry (Set on entry) *
* R12= Work register (Shared_storage) *
* *
* Logic: *
* Local_Request: *
* If entry_name ^= new_name then *
* Call Getmain_Shared *
* Copy new_name into shared storage *
* Address the command plist *
* Update ADDR1 to point to address of the new TS QUEUE name *
* Set the Hi-order bit if last address in CLPS *
* End If *
* Return *
*=====*
LOCAL_REQUEST DS 0H
    USING TABLE_ENTRY,R9      R9 points to the table entry
    CLC NEW_NAME,0(R7)         Is the new_name=current_queue name?
    BE RETURN                  ..Yes Return
*
* Obtain Shared storage to hold the new queue name
    BAL R6,GETMAIN_SHARED     GETMAIN SHARED storage
    L R12,UEPTQTOK           Fetch address of token
    L R12,0(R12)             Fetch shared storage pointer
    USING SHARED_STORAGE,R12  Address using R12
    MVC SHARED_NAME,NEW_NAME  Copy QNAME into shared storage
*
* Update the Queue Name in CLPS
    L R8,UEPCLPS             Address the CLPS.
    USING TS_ADDR_LIST,R8    ..with Register 8
    LA R1,SHARED_NAME        Fetch address of the new QNAME
    TM TS_ADDR1,X'80'        Is the hi-order bit on?
    BZ LOCAL1                ..No continue
    O R1,=X'80000000'        Indicate ADDR1 is last parameter
LOCAL1 DS 0H
    ST R1,TS_ADDR1           Store address in TS_ADDR1
    B RETURN                 Return
    DROP R8                  Drop TS_ADDR_LIST
    DROP R12                 Drop SHARED_STORAGE
    DROP R9                  Drop addressability to Entry
    EJECT ,
*

```

Figure 141. Example exit program for the XTSEREQ exit (part 8)

```

*=====
* ROUTE_REQUEST: Ship request to remote system
* An entry has been found in the TS_Routing Table for this TS
* Queue Name. The request is modified by adding a SYSID to the
* command and renaming the queue if required.
*
* Registers:
* R1 = Work register
* R6 = Link Register
* R7 = Address of current Queue name (Set on entry)
* R8 = Command Parameter List (CLPS)
* R9 = Address of table entry (Set on entry)
* R12= Work register (Shared_storage)
*
* Logic:
* Route Request:
* Call Getmain_Shared
* If entry_name ^= new_name then
* Copy new_name into shared storage
* Address the command plist
* Update ADDR1 to point to address of the new TS QUEUE name
* End If
* Copy new_sysid into shared storage
* Address the command plist
* Update ADDR7 to point to the address of the new SYSID
* Set the SYSID existence bit in the EID
* Set the Hi-order bit in last address in CLPS
* Return
*=====
ROUTE_REQUEST DS 0H
    BAL R6,GETMAIN_SHARED GETMAIN SHARED storage
    L R12,UEPTQTOK Fetch address of token
    L R12,0(R12) Fetch Shared storage address
    USING SHARED_STORAGE,R12 Address using R12
*
* Update the Queue Name in CLPS
    USING TABLE_ENTRY,R9 R9 points to the table entry
    CLC NEW_NAME,0(R7) Is the new_name=current_queue name?
    BE ROUTE1 ..Yes No need to update Queue Name
    MVC SHARED_NAME,NEW_NAME Copy QNAME into shared storage
    L R8,UEPCLPS Address the CLPS..
    USING TS_ADDR_LIST,R8 ..with Register 8
    LA R1,SHARED_NAME Fetch address of the new QNAME
    ST R1,TS_ADDR1 Store address in TS_ADDR1
    DROP R8 Drop TS_ADDR_LIST
*

```

Figure 142. Example exit program for the XTSEREQ exit (part 9)

```

*      Update the Sysid in CLPS
ROUTE1 DS    0H
MVC    SHARED_SYSID,NEW_SYSID Copy SYSID into shared storage
L      R8,UEPCLPS           Address the CLPS..
USING  TS_ADDR_LIST,R8     ..with Register 8
L      R1,TS_ADDR0         Address the EID..
USING  TS_EID,R1          ..with Register 1
OI     TS_BITS1,TS_SYSID_V Indicate SYSID now present in CLPS
DROP   R1                  Drop addressability to EID
LA     R1,SHARED_SYSID     Fetch address of the new SYSID
ST     R1,TS_ADDR7        Store address in TS_ADDR7
OI     TS_ADDR7,X'80'     Indicate SYSID is end of plist
*
*      Clear hi-order bits in ARGs 1 to 5
NI     TS_ADDR1,X'7F'      Indicate not last parameter in CLPS
NI     TS_ADDR2,X'7F'      Indicate not last parameter in CLPS
NI     TS_ADDR3,X'7F'      Indicate not last parameter in CLPS
NI     TS_ADDR4,X'7F'      Indicate not last parameter in CLPS
NI     TS_ADDR5,X'7F'      Indicate not last parameter in CLPS
B      RETURN              Return
DROP   R8                  Drop TS_ADDR_LIST
DROP   R12                 Drop SHARED_STORAGE
DROP   R9                  Drop addressability to Entry
EJECT ,
*
*=====
* ENTRY_NOT_FOUND - No entry was found in the TS_Routing_Table *
* No entry found in Routing Table for this TS Queue Name. In the *
* sample program, all such requests are routed. *
* *
* Registers: *
* R1 = Work register *
* R6 = Link Register *
* R8 = Command Parameter List (CLPS) *
* R12= Work register (Shared_storage) *
* *

```

Figure 143. Example exit program for the XTSEREQ exit (part 10)

```

* Logic:
*   Entry_Not_Found:
*   Call Getmain_Shared
*   Copy default_sysid into shared storage
*   Address the command plist
*   Update ADDR7 to point to the address of the default SYSID
*   Set the SYSID existence bit in the EID
*   Set the Hi-order bit in last address in CLPS
*   Return
*=====
ENTRY_NOT_FOUND DS 0H
    BAL  R6,GETMAIN_SHARED    GETMAIN SHARED storage
    L    R12,UEPTQTOK        Fetch address of token
    L    R12,0(R12)          Fetch shared storage address
    USING SHARED_STORAGE,R12 Address using R12

*
*   Update the Sysid in CLPS
MVC  SHARED_SYSID,DEFAULT_SYSID Copy SYSID to shared storage
L    R8,UEPCLPS            Address the CLPS..
USING TS_ADDR_LIST,R8     ..with Register 8
L    R1,TS_ADDR0           Address the EID..
USING TS_EID,R1           ..with Register 1
OI   TS_BITS1,TS_SYSID_V  Indicate SYSID now present in CLPS
DROP R1                    Drop addressability to EID
LA   R1,SHARED_SYSID      Fetch address of the new SYSID
ST   R1,TS_ADDR7          Store address in TS_ADDR7
OI   TS_ADDR7,X'80'       Indicate SYSID is end of plist

*
*   Clear hi-order bits in ARGs 1 to 5
NI   TS_ADDR1,X'7F'        Indicate not last parameter in CLPS
NI   TS_ADDR2,X'7F'        Indicate not last parameter in CLPS
NI   TS_ADDR3,X'7F'        Indicate not last parameter in CLPS
NI   TS_ADDR4,X'7F'        Indicate not last parameter in CLPS
NI   TS_ADDR5,X'7F'        Indicate not last parameter in CLPS
B    RETURN                Return
DROP R8                    Drop TS_ADDR_LIST
DROP R12                   Drop SHARED_STORAGE
EJECT ,

*

```

Figure 144. Example exit program for the XTSEREQ exit (part 11)

```

*=====*
* GETMAIN_SHARED - Obtain Shared storage *
* * *
* Registers: *
* R0 = Used by EXEC CICS call *
* R1 = Used by EXEC CICS call *
* Work Register *
* R6 = Link Register - Return Address *
* R11= EIB register (set on entry) *
* R12= Work register *
* R14= Used by EXEC CICS call *
* R15= Used by EXEC CICS call *
* *
* Logic: *
* Getmain_Shared: *
* EXEC CICS GETMAIN LENGTH(32) SET(UEPTQTOK) SHARED RESP(resp) *
* If resp ^= OK then *
* Call Error(Getmain_Failed) *
* Else *
* Address shared storage *
* Set eyecatcher 'XTSEREQ Storage' *
* End If *
* Return *
*=====*
GETMAIN_SHARED DS 0H
L R12,UEPTQTOK Fetch address of token
L R12,0(R12) Fetch shared storage anchor
LTR R12,R12 Is the storage already present?
BNZR R6 ..Yes Return
EXEC CICS GETMAIN LENGTH(32) SET(R12) SHARED X
INITIMG(X'00') RESP(RESP)
CLC RESP,DFHRESP(NORMAL) GETMAIN worked OK?
BNE ERROR7 ..No Goto Error routine
L R1,UEPTQTOK Fetch address of token
ST R12,0(R1) Save address of storage
USING SHARED_STORAGE,R12
MVC SHARED_EYECATCHER,EYE_CATCHER Set Eyecatcher
DROP R12 Drop R12
BR R6 Return to caller
EJECT ,
*

```

Figure 145. Example exit program for the XTSEREQ exit (part 12)

```

*=====*
* FREEMAIN_SHARED - Free shared storage *
* Free the shared storage associated with this command. *
* Registers: *
* R0 = Used by EXEC CICS call *
* R1 = Used by EXEC CICS call *
* R6 = Link Register - Return Address *
* R11= EIB register (set on entry) *
* R12= Work register *
* R14= Used by EXEC CICS call *
* R15= Used by EXEC CICS call *
* Logic: *
* Freemain_Shared: *
* Address shared storage *
* If eyecatcher ^= 'XTSEREQ Storage' then *
* Call Error(Freemain_Logic_Error) *
* Else *
* EXEC CICS FREEMAIN DATAPOINTER(UEPTQTOK) RESP(resp) *
* If resp ^= OK then *
* Call Error(Freemain_Failed) *
* End If *
* End If *
* Return *
*=====*
FREEMAIN_SHARED DS 0H
    L    R12,UEPTQTOK           Fetch token address
    L    R12,0(R12)            Address shared storage address
    USING SHARED_STORAGE,R12   ..Using R12
    CLC  SHARED_EYECATCHER,EYE_CATCHER Is this our storage?
    BNE  ERROR8                ..No Goto Error routine
    DROP R12                   Drop R12
    EXEC CICS FREEMAIN DATAPOINTER(R12) RESP(RESP)
    CLC  RESP,DFHRESP(NORMAL)  FREEMAIN worked OK?
    BNE  ERROR9                ..No Goto Error routine
    L    R12,UEPTQTOK           Fetch token address
    XC   0(4,R12),0(R12)        Clear token address
    BR   R6                    Return to caller
    EJECT ,
*=====*
* Trace Routines *
* Issue a Trace XPI call *
* *
* Registers: *
* R0 = Used by XPI call *
* R1 = DFHTRPT plist *
* R6 = Link Register - Return Address *
* R12= Work register *
* R13= EISTG register (set by DFHEIENT) *
* Kernel Stack entry *
* R14= Used by XPI call *
* R15= Used by XPI call *
*=====*

```

Figure 146. Example exit program for the XTSEREQ exit (part 13)

```

USING DFHTRPT ARG,R1
TRACE_ENTRY DS 0H
    L    R1,UEPXSTOR      Prepare for XPI call
    DFHTRPTX CLEAR,      X
        POINT_ID(TR_ENTRY)
    B    ISSUE_TRACE
TRACE_EXIT DS 0H
    L    R1,UEPXSTOR      Prepare for XPI call
    DFHTRPTX CLEAR,      X
        POINT_ID(TR_EXIT)
    B    ISSUE_TRACE
TRACE_ERROR DS 0H
    L    R1,UEPXSTOR      Prepare for XPI call
    DFHTRPTX CLEAR,      X
        POINT_ID(TR_ERROR),
        DATA1(TR_ERROR_N,1)
    BAL  R6,ISSUE_TRACE
    B    RETURN
*
*-----*
* Issue the Trace XPI call
*-----*
ISSUE_TRACE DS 0H
    L    R8,UEPTRACE      Address of trace flag
    TM   0(R8),UEPTRON    Is trace on?
    BZ   NO_TRACE         No - do not issue trace then
    LR   R12,R13          Save R13 round XPI call
    L    R13,UEPSTACK
    DFHTRPTX CALL,      X
        IN,              X
        FUNCTION(TRACE_PUT),
        POINT_ID(*),     X
        OUT,              X
        RESPONSE(*),    X
        REASON(*)
    LR   R13,R12          Restore R13 (DFHEISTG)
NO_TRACE DS 0H
    BR   R6              Return to caller
    DROP R1
*
*-----*
* ERRORn
* Error has occurred during processing
* Issue a trace point and return to the CICS
*-----*
ERROR1 DS 0H
    MVI  TR_ERROR_N,1
    B    TRACE_ERROR
ERROR2 DS 0H
    MVI  TR_ERROR_N,2
    B    TRACE_ERROR
ERROR3 DS 0H
    MVI  TR_ERROR_N,3
    B    TRACE_ERROR

```

Figure 147. Example exit program for the XTSEREQ exit (part 14)



```

ERROR4  DS  0H
        MVI TR_ERROR_N,4
        B   TRACE_ERROR
ERROR5  DS  0H
        MVI TR_ERROR_N,5
        B   TRACE_ERROR
ERROR6  DS  0H
        MVI TR_ERROR_N,6
        B   TRACE_ERROR
ERROR7  DS  0H
        MVI TR_ERROR_N,7
        B   TRACE_ERROR
ERROR8  DS  0H
        MVI TR_ERROR_N,7
        B   TRACE_ERROR
ERROR9  DS  0H
        MVI TR_ERROR_N,7
        B   TRACE_ERROR
        EJECT ,
        DROP R2           Drop DFHUEPAR
        DROP R11         Drop EIB
        LTORG ,
*****
*  CONSTANTS
*****
        DS 0D
EYE_CATCHER  DC CL16'XTSEREQ Storage '
DEFAULT_SYSID DC CL4'MQ1 '
LOCAL        EQU X'01'
ROUTE        EQU X'02'
*
* Trace point ids
TR_ENTRY     DC XL2'120'
TR_EXIT      DC XL2'121'
TR_ERROR     DC XL2'122'
*
*-----*
*  TABLE_ENTRY:
*-----*
*  | Entry_Name | New_Name | QOR_Sysid | Action | *filler* |
*  | Char 8     | Char 8   | Char 4    | Bin 1  | Char 3   |
*-----*
*  Last Entry is indicated by special TS_Queue Name
*-----*

```

Figure 148. Example exit program for the XTSEREQ exit (part 15)

```

TS_ROUTING_TABLE DS 0D
ENTRY_NAME_1     DC CL8'AAAAAAA'      Rename Queue AAAAAAA as
NEW_NAME_1       DC CL8'BBBBBBBB'     BBBBBBBBB
QOR_SYSID_1      DC CL4' '
ACTION_1         DC XL1'01'           Local request
FILLER_1         DC CL3' '
ENTRY_NAME_2     DC CL8'A1 '          Rename Queue A1 as
NEW_NAME_2       DC CL8'B1 '          B1
QOR_SYSID_2      DC CL4' '
ACTION_2         DC XL1'01'           Local request
FILLER_2         DC CL3' '
ENTRY_NAME_3     DC CL8'A2 '          Rename Queue A2 as
NEW_NAME_3       DC CL8'B2 '          B2
QOR_SYSID_3      DC CL4' '
ACTION_3         DC XL1'01'           Local request
FILLER_3         DC CL3' '
ENTRY_NAME_4     DC CL8'RRRRRRR'      Rename Queue RRRRRRR as
NEW_NAME_4       DC CL8'REMOTE '      REMOTE and ship request
QOR_SYSID_4      DC CL4'MQ1 '         to System MQ1
ACTION_4         DC XL1'02'
FILLER_4         DC CL3' '
ENTRY_NAME_5     DC CL8'R1 '          Don't rename Queue R1, but
NEW_NAME_5       DC CL8'R1 '          ship request to System MQ1
QOR_SYSID_5      DC CL4'MQ1 '
ACTION_5         DC XL1'02'
FILLER_5         DC CL3' '
ENTRY_NAME_LAST  DC XL8'FFFFFFFFFFFFFF'
NEW_NAME_LAST    DC CL8' '
QOR_SYSID_LAST   DC CL4' '
ACTION_LAST      DC XL1'00'
FILLER_LAST      DC CL3' '
                END DFH$XTSE

```

Figure 149. Example exit program for the XTSEREQ exit (part 16)

Before using the sample program in a production environment, you would need to customize it to suit your installation.

---

## Appendix G. Threadsafe XPI commands

Most, but not all, XPI commands are threadsafe. Issuing any of the non-threadsafe commands causes CICS to use the QR TCB to ensure serialization. The XPI commands that are threadsafe are indicated in the command syntax diagrams in Chapter 3, “The user exit programming interface (XPI),” on page 305 with the statement: “This command is threadsafe”, and are listed here.

### Threadsafe commands:

- DFHDSSRX ADD\_SUSPEND
- DFHDSSRX SUSPEND
- DFHDSSRX RESUME
- DFHDSSRX DELETE\_SUSPEND
- DFHDSSRX WAIT\_MVS
- DFHDSATX CHANGE\_PRIORITY
- DFHDUDUX SYSTEM\_DUMP
- DFHNQEDX ENQUEUE
- DFHNQEDX DEQUEUE
- DFHKEDSX START\_PURGE\_PROTECTION
- DFHKEDSX STOP\_PURGE\_PROTECTION
- DFHLDLDX ACQUIRE\_PROGRAM
- DFHLDLDX DEFINE\_PROGRAM
- DFHLDLDX DELETE\_PROGRAM
- DFHLDLDX RELEASE\_PROGRAM
- DFHLGPAX INQUIRE\_PARAMETERS
- DFHLGPAX SET\_PARAMETERS
- DFHMNMNX MONITOR
- DFHMNMNX INQUIRE\_MONITORING\_DATA
- DFHPGISX INQUIRE\_PROGRAM
- DFHPGISX INQUIRE\_CURRENT\_PROGRAM
- DFHPGISX SET\_PROGRAM
- DFHPGISX START\_BROWSE\_PROGRAM
- DFHPGISX GET\_NEXT\_PROGRAM
- DFHPGISX END\_BROWSE\_PROGRAM
- DFHPGAQX INQUIRE\_AUTOINSTALL
- DFHPGAQX SET\_AUTOINSTALL
- DFHAPIQX INQ\_APPLICATION\_DATA
- DFHSAIQX INQUIRE\_SYSTEM
- DFHSAIQX SET\_SYSTEM
- DFHSMMCX GETMAIN
- DFHSMMCX FREEMAIN
- DFHSMMCX INQUIRE\_ELEMENT\_LENGTH
- DFHSMMCX INQUIRE\_TASK\_STORAGE
- DFHSMSRX INQUIRE\_ACCESS
- DFHSMSRX INQUIRE\_SHORT\_ON\_STORAGE
- DFHSMSRX SWITCH\_SUBSPACE
- DFHTRPTX TRACE\_PUT
- DFHBRIQX INQUIRE\_CONTEXT
- DFHXMSRX INQUIRE\_DTRTRAN
- DFHXMSRX INQUIRE\_MXT
- DFHXMCLX INQUIRE\_TCLASS
- DFHXMIDX INQUIRE\_TRANDEF
- DFHXMIQX INQUIRE\_TRANSACTION
- DFHXMIQX SET\_TRANSACTION
- DFHJCJCX WRITE\_JOURNAL\_DATA

**Non-threadsafe commands:**

- DFHDUDUX TRANSACTION\_DUMP

---

## Bibliography

---

### The CICS Transaction Server for z/OS library

The published information for CICS Transaction Server for z/OS is delivered in the following forms:

#### The CICS Transaction Server for z/OS Information Center

The CICS Transaction Server for z/OS Information Center is the primary source of user information for CICS Transaction Server. The Information Center contains:

- Information for CICS Transaction Server in HTML format.
- Licensed and unlicensed CICS Transaction Server books provided as Adobe Portable Document Format (PDF) files. You can use these files to print hardcopy of the books. For more information, see “PDF-only books.”
- Information for related products in HTML format and PDF files.

One copy of the CICS Information Center, on a CD-ROM, is provided automatically with the product. Further copies can be ordered, at no additional charge, by specifying the Information Center feature number, 7014.

Licensed documentation is available only to licensees of the product. A version of the Information Center that contains only unlicensed information is available through the publications ordering system, order number SK3T-6945.

#### Entitlement hardcopy books

The following essential publications, in hardcopy form, are provided automatically with the product. For more information, see “The entitlement set.”

### The entitlement set

The entitlement set comprises the following hardcopy books, which are provided automatically when you order CICS Transaction Server for z/OS, Version 3 Release 2:

*Memo to Licensees*, GI10-2559  
*CICS Transaction Server for z/OS Program Directory*, GI13-0515  
*CICS Transaction Server for z/OS Release Guide*, GC34-6811  
*CICS Transaction Server for z/OS Installation Guide*, GC34-6812  
*CICS Transaction Server for z/OS Licensed Program Specification*, GC34-6608

You can order further copies of the following books in the entitlement set, using the order number quoted above:

*CICS Transaction Server for z/OS Release Guide*  
*CICS Transaction Server for z/OS Installation Guide*  
*CICS Transaction Server for z/OS Licensed Program Specification*

### PDF-only books

The following books are available in the CICS Information Center as Adobe Portable Document Format (PDF) files:

#### CICS books for CICS Transaction Server for z/OS

##### General

*CICS Transaction Server for z/OS Program Directory*, GI13-0515  
*CICS Transaction Server for z/OS Release Guide*, GC34-6811

*CICS Transaction Server for z/OS Migration from CICS TS Version 3.1*, GC34-6858  
*CICS Transaction Server for z/OS Migration from CICS TS Version 1.3*, GC34-6855  
*CICS Transaction Server for z/OS Migration from CICS TS Version 2.2*, GC34-6856  
*CICS Transaction Server for z/OS Installation Guide*, GC34-6812

#### **Administration**

*CICS System Definition Guide*, SC34-6813  
*CICS Customization Guide*, SC34-6814  
*CICS Resource Definition Guide*, SC34-6815  
*CICS Operations and Utilities Guide*, SC34-6816  
*CICS Supplied Transactions*, SC34-6817

#### **Programming**

*CICS Application Programming Guide*, SC34-6818  
*CICS Application Programming Reference*, SC34-6819  
*CICS System Programming Reference*, SC34-6820  
*CICS Front End Programming Interface User's Guide*, SC34-6821  
*CICS C++ OO Class Libraries*, SC34-6822  
*CICS Distributed Transaction Programming Guide*, SC34-6823  
*CICS Business Transaction Services*, SC34-6824  
*Java Applications in CICS*, SC34-6825  
*JCICS Class Reference*, SC34-6001

#### **Diagnosis**

*CICS Problem Determination Guide*, SC34-6826  
*CICS Messages and Codes*, GC34-6827  
*CICS Diagnosis Reference*, GC34-6862  
*CICS Data Areas*, GC34-6863-00  
*CICS Trace Entries*, SC34-6828  
*CICS Supplementary Data Areas*, GC34-6864-00

#### **Communication**

*CICS Intercommunication Guide*, SC34-6829  
*CICS External Interfaces Guide*, SC34-6830  
*CICS Internet Guide*, SC34-6831

#### **Special topics**

*CICS Recovery and Restart Guide*, SC34-6832  
*CICS Performance Guide*, SC34-6833  
*CICS IMS Database Control Guide*, SC34-6834  
*CICS RACF Security Guide*, SC34-6835  
*CICS Shared Data Tables Guide*, SC34-6836  
*CICS DB2 Guide*, SC34-6837  
*CICS Debugging Tools Interfaces Reference*, GC34-6865

### **CICSplex SM books for CICS Transaction Server for z/OS**

#### **General**

*CICSplex SM Concepts and Planning*, SC34-6839  
*CICSplex SM User Interface Guide*, SC34-6840  
*CICSplex SM Web User Interface Guide*, SC34-6841

#### **Administration and Management**

*CICSplex SM Administration*, SC34-6842  
*CICSplex SM Operations Views Reference*, SC34-6843  
*CICSplex SM Monitor Views Reference*, SC34-6844  
*CICSplex SM Managing Workloads*, SC34-6845  
*CICSplex SM Managing Resource Usage*, SC34-6846  
*CICSplex SM Managing Business Applications*, SC34-6847

#### **Programming**

*CICSplex SM Application Programming Guide*, SC34-6848  
*CICSplex SM Application Programming Reference*, SC34-6849

### Diagnosis

*CICSplex SM Resource Tables Reference*, SC34-6850  
*CICSplex SM Messages and Codes*, GC34-6851  
*CICSplex SM Problem Determination*, GC34-6852

### CICS family books

#### Communication

*CICS Family: Interproduct Communication*, SC34-6853  
*CICS Family: Communicating from CICS on zSeries*, SC34-6854

#### Licensed publications

The following licensed publications are not included in the unlicensed version of the Information Center:

*CICS Diagnosis Reference*, GC34-6862  
*CICS Data Areas*, GC34-6863-00  
*CICS Supplementary Data Areas*, GC34-6864-00  
*CICS Debugging Tools Interfaces Reference*, GC34-6865

---

## Other CICS books

The following publications contain further information about CICS, but are not provided as part of CICS Transaction Server for z/OS, Version 3 Release 2.

<i>Designing and Programming CICS Applications</i>	SR23-9692
<i>CICS Application Migration Aid Guide</i>	SC33-0768
<i>CICS Family: API Structure</i>	SC33-1007
<i>CICS Family: Client/Server Programming</i>	SC33-1435
<i>CICS Transaction Gateway for z/OS Administration</i>	SC34-5528
<i>CICS Family: General Information</i>	GC33-0155
<i>CICS 4.1 Sample Applications Guide</i>	SC33-1173
<i>CICS/ESA 3.3 XRF Guide</i>	SC33-0661

---

## Books from related libraries

This section lists the non-CICS books that are referred to in this manual.

### MVS books

Short Title	Full Title
<i>Assembler Programming Guide</i>	<i>OS/390 MVS Assembler Services Guide</i> , GC28-1762
<i>Authorized Assembler Programming Guide</i>	<i>OS/390 MVS Authorized Assembler Services Guide</i> , GC28-1763
<i>Authorized Assembler Programming Reference Volume 1</i>	<i>OS/390 MVS Authorized Assembler Services Reference ALE-DYN</i> , GC28-1764
<i>Authorized Assembler Programming Reference Volume 2</i>	<i>OS/390 MVS Authorized Assembler Services Reference ENF-IXG</i> , GC28-1765
<i>Authorized Assembler Programming Reference Volume 3</i>	<i>OS/390 MVS Authorized Assembler Services Reference LLA-SDU</i> , GC28-1766
<i>Authorized Assembler Programming Reference Volume 4</i>	<i>OS/390 MVS Authorized Assembler Services Reference SET-WTO</i> , GC28-1767

Short Title	Full Title
<i>Data Areas Volume 1</i>	<i>OS/390 MVS Data Areas, Vol 1 (ABEP-DALT), SY28-1164</i>
<i>Data Areas Volume 2</i>	<i>OS/390 MVS Data Areas, Vol 2 (DCCB-ITTCTE), SY28-1165</i>
<i>Data Areas Volume 3</i>	<i>OS/390 MVS Data Areas, Vol 3 (IVT-RCWK), SY28-1166</i>
<i>Data Areas Volume 4</i>	<i>OS/390 MVS Data Areas, Vol 4 (RD-SRRA), SY28-1167</i>
<i>Data Areas Volume 5</i>	<i>OS/390 MVS Data Areas, Vol 5 (SSAG-XTLST), SY28-1168</i>
—	<i>MVS/ESA Resource Measurement Facility (RMF), Version 5—Monitor I &amp; II Reference and User's Guide, LY28-1007</i>
<i>System Management Facilities</i>	<i>z/OS MVS System Management Facilities (SMF), GC28-1783</i>

## VTAM books

*OS/390 eNetwork Communications Server: SNA Network Implementation, SC31-8563*

*OS/390 eNetwork Communications Server: SNA Programming, SC31-8573*

## Other related books

*IBM ESA/370 Principles of Operation, SA22-7200*

*IMS/ESA Application Programming: DL/I Calls, SC26-3062*

*OS/390 Security Server External Security Interface (RACROUTE) Macro Reference, GC28-1922*

*OS/390 Security Server (RACF) Security Administrator's Guide, SC28-1915*

*Service Level Reporter Version 3 General Information, GH19-6529*

*SNA Formats, GA27-3136*

*SNA Sessions Between Logical Units, GC20-1868*

---

## Determining if a publication is current

IBM regularly updates its publications with new and changed information. When first published, both hardcopy and BookManager® softcopy versions of a publication are usually in step. However, due to the time required to print and distribute hardcopy books, the BookManager version is more likely to have had last-minute changes made to it before publication.

Subsequent updates will probably be available in softcopy before they are available in hardcopy. This means that at any time from the availability of a release, softcopy versions should be regarded as the most up-to-date.

For CICS Transaction Server books, these softcopy updates appear regularly on the *Transaction Processing and Data Collection Kit* CD-ROM, SK2T-0730-xx. Each reissue of the collection kit is indicated by an updated order number suffix (the -xx part). For example, collection kit SK2T-0730-06 is more up-to-date than SK2T-0730-05. The collection kit is also clearly dated on the cover.



Updates to the softcopy are clearly marked by revision codes (usually a # character) to the left of the changes.



---

## Accessibility

Accessibility features help a user who has a physical disability, such as restricted mobility or limited vision, to use software products successfully.

You can perform most tasks required to set up, run, and maintain your CICS system in one of these ways:

- using a 3270 emulator logged on to CICS
- using a 3270 emulator logged on to TSO
- using a 3270 emulator as an MVS system console

IBM Personal Communications provides 3270 emulation with accessibility features for people with disabilities. You can use this product to provide the accessibility features you need in your CICS system.



---

# Index

## Special characters

- “good night” transaction
  - customizing the sample program 804
  - overview 801
  - sample program, DFH0GNIT 803

## Numerics

- 3270 bridge
  - bridge exit 661
  - bridge exit program 661
- 3270 information display system
  - error processors (optional) 498
  - unavailable printer
    - DFHZNEP 506

## A

- abends
  - transaction bit 472
- abnormal conditions
  - in terminal error programs 470
  - sample node error program 496
  - sample terminal error program 451
  - user-written node error programs 505
- abort write bit 472
- ACF/VTAM
  - application routing failure 495
  - automatic installation 515
  - CINIT request unit 518
  - CLSDST PASS function 495
  - default DFHZNEP 480
  - DFHZNAC logging facility 494
  - entries in LOGON mode table 833
  - error-handling 480
    - DFHZNAC/DFHZNEP interface 480
    - DFHZNAC/DFHZNEP interface action flags 481
  - generic resources 547
    - node error program 512
  - ISTINCLM values 835
  - node error program (DFHZNEP) 496
  - PSERVIC values 840
  - session failures
    - user-written NEPs 507
  - transaction-class error-handling routine 487
  - VTAM LOGON mode table 516
- ACQUIRE PROGRAM function of the XPI 356
- action flag names, DFHTEP 457
- adapter, task-related user exits 267
- ADD SUSPEND function of the XPI 334
- addressing mode implications 289
- ADYN, dynamic allocation transaction 782
- AIEXIT, system initialization parameter 516, 544
- AIDELAY, system initialization parameter 195
- AIRDELAY, system initialization parameter 511

- allocate queues
  - controlling the length of
    - using the XISCONA global user exit 138
    - using the XISQUE global user exit 258
    - using the XZIQUE global user exit 249
- Alphabetical list of GLUEs 25
- APPC connections
  - intersystem queues 249
  - XZIQUE global user exit
    - for controlling intersystem queues 249
- APPC connections, automatic installation of 543
- assembling and link-editing a user-replaceable program 436
- autoinstall user-replaceable programs
  - for APPC connections (DFHZATDY) 543
  - for bridge facilities 567
  - for IPIC connections (DFHISAIP) 553
  - for programs (DFHPDADX) 579
  - for shipped terminals
    - DFHZATDX 559
    - DFHZATDY 559
  - for terminals (DFHZATDX) 527
  - for virtual terminals
    - DFHZATDX 567
    - DFHZATDY 567
- automatic installation of APPC connections
  - benefits of 544
  - control program
    - at delete 549
    - parameter list at install 545
    - purpose of 545
  - introduction 543
  - model definitions 543
  - parallel-session 543
  - recovery and restart 545
  - requirements for 544
  - single-session
    - initiated by BIND 543
    - initiated by CINIT 543
  - supplied resource definitions 551
  - templates 544
  - the sample program 550
    - default actions 550
- automatic installation of IP connections
  - supplied resource definitions 558
- automatic installation of IPCONN
  - templates 553
  - user program
    - purpose of 553
- automatic installation of IPCONNn
  - benefits of autoinstall 553
  - requirements 553
  - the sample program 557
    - default actions 558
  - user program
    - at delete 556
    - parameter list at install 555

- automatic installation of IPIC connections
  - introduction 553
  - preliminary considerations 553
- automatic installation of programs
  - benefits of 581
  - control program
    - parameter list at install 583
    - testing 588
  - installation of mapsets 581
  - introduction 579
  - model definitions 580
  - requirements for 582
  - supplied resource definitions 587
  - system autoinstall 581
  - the sample programs
    - customizing 586
    - DFHPGADX 586
    - DFHPGAHX 586
    - DFHPGALX 586
    - DFHPGAOX 586
- automatic installation of shipped terminals
  - control program
    - parameter list at delete 564
    - parameter list at install 562
  - introduction 559
- automatic installation of terminals
  - control program
    - action at delete 525
    - action at install 517
    - action on return 523
    - information returned to CICS 520
    - naming 526
    - testing and debugging 526
  - parameter list at logon 518
  - the sample programs
    - customizing 528
    - DFHZATDX 527
    - DFHZCTDX 527
    - DFHZDTEX 527
    - DFHZPTDX 527
  - VTAM LOGON mode table 516
- automatic installation of virtual terminals
  - control program
    - parameter list at delete 575
    - parameter list at install 571
  - introduction 567

## B

- Basic Mapping Support (BMS)
  - global user exit points 34
- BIND\_LDAP function of the XPI 321
- bridge
  - dynamic routing of requests
    - changing parameters 604
    - eligibility for routing 603
    - error handling 605
    - re-invoking 606
    - terminating a request 605
- bridge (3270)
  - bridge exit 661

- bridge facilities
  - autoinstall control program
    - parameter list at install 573
  - autoinstall user-replaceable programs 567

## C

- CAVM data sets, opening by overseer program 692
- CEBT function in the overseer program 704
- CEDA transaction
  - programmable interface to 809
- CEMT INQUIRE AUTOINSTALL 526
- CEMT SET AUTOINSTALL 526
- CESD, default shutdown assist transaction 429
- CHANGE PRIORITY function of the XPI 344
- CICS monitoring facility
  - monitoring control table
    - DFHMCT TYPE=RECORD macro 748
- CICS system definition utility program (DFHCSDUP)
  - as a batch program
    - EXTRACT command 814
    - link-edit statements for user program 819
    - parameters passed from DFHCSDUP to the user program 815
    - when the user program is invoked 815
    - writing a program for EXTRACT processing 814
  - invocation from a user program
    - entry parameters for DFHCSDUP 822
    - introduction 821
    - responsibilities of the user program 824
    - user exits in DFHCSDUP 824
  - overview 813
  - running under TSO 821
  - sample programs
    - CSD backup utility program 818
    - CSD cross-referencing program 818
    - DB2 formatting program 818
    - DFH\$CRFA 816
    - DFH\$CRFP 816
    - DFH\$FORA 817
    - DFH\$FORP 817
    - DFH0CBDC 817
    - DFH0CRFC 816
    - DFH0FORC 817
- CICS-DBCTL interface status program (DFHDBUEX)
  - communications area 659
  - introduction to 659
  - sample program 660
- CINIT request unit 518
- CINIT, VTAM 527
- CLSDSTP, system initialization parameter 495
- CODE operand
  - DFHSNEP TYPE=ERRPROC 501
  - DFHTEPM TYPE=ERRPROC 463
  - DFHTEPT TYPE=BUCKET 468
  - DFHTEPT TYPE=PERMCODEIERRCODE 466
- common subroutine vector table (CSVT) 497, 504
- communication area
  - terminal error program 451

communications area  
  autoinstall control program  
    APPC connections 545  
    programs 583  
    terminals 518  
  autoinstall user program  
    IPCONNs 555  
  CICSDBCTL interface status program 659  
  distributed routing program 645  
  dynamic routing program 607  
  node error program 487  
  program error program 441  
  terminal error program 471  
  transaction restart program 446  
consoles, automatic installation 535  
COUNT operand  
  DFHSNET macro 503  
  DFHTEPT TYPE=PERMCODEIERRCODE 466  
  limits, default threshold for TEP 466  
CS operand  
  DFHSNEP TYPE=INITIAL 500  
CSD backup utility program  
  for DFHCSDUP 818  
CSD cross-referencing program  
  for DFHCSDUP 818  
CSD utility program (DFHCSDUP) 818  
CSNE transaction 480  
CSVT (common subroutine vector table) 497  
customizing the overseer program 703

**D**

data tables 40  
database control (DBCTL)  
  DBCTL information about the CAVM data sets 702  
  DFHDBUEX 659  
  DFHMCT TYPE=EMP entries 749  
  in an XRF environment 704  
  interface status 659  
DB2 formatting program  
  for DFHCSDUP 818  
DBCTL (database control)  
  DBCTL information about the CAVM data sets 702  
  DFHDBUEX 659  
  DFHMCT TYPE=EMP entries 749  
  in an XRF environment 704  
  interface status 659  
DBLID values 701  
DECB, terminal error program  
  information 458  
  operand 458  
DEFAULT operand  
  DFHZNEPI TYPE=INITIAL 509  
default threshold count limits  
  DFHTEP (terminal error program) 466  
DEFINE PROGRAM function of the XPI 353  
defining terminal error blocks 465  
DELETE PROGRAM function of the XPI 359  
DELETE SUSPEND function of the XPI 340  
DEQUEUE function of the XPI 350  
DFH\$APAD, sample global user exit program 18  
DFH\$AXRO, sample overseer program 693  
DFH\$BMXT, sample global user exit program 18  
DFH\$CRFA, cross-reference program,  
  assembler-language 816  
DFH\$CRFP, cross-reference program, PL/I 816  
DFH\$DTAD, sample global user exit program 18  
DFH\$DTLC, sample global user exit program 18  
DFH\$DTRD, sample global user exit program 18  
DFH\$FCBF, sample global user exit program 19, 130  
DFH\$FCBV, sample global user exit program 19, 134  
DFH\$FLD, sample global user exit program 20, 136  
DFH\$FORA, formatting program, assembler-  
  language 817  
DFH\$FORP, formatting program, PL/I 817  
DFH\$ICCN, sample global user exit program 23, 162  
DFH\$LGLS, sample global user exit program 23, 167  
DFH\$PCEX, sample global user exit program 16, 188  
DFH\$PCPI, sample program for global user exits 16  
DFH\$PCTA, sample global user exit program 24, 191  
DFH\$PIEX, sample global user exit program 24  
DFH\$SXPN, sample global user exit programs 23, 171  
DFH\$TDWT, transient data write-to-terminal  
  program 873  
DFH\$WBEX, sample global user exit program 21  
DFH\$WBGA, sample global user exit program 20  
DFH\$WBLD 21, 22  
DFH\$WBPI, sample global user exit program 20  
DFH\$WBX2, sample global user exit program 21, 22  
DFH\$XDRQ, sample global user exit program 19  
DFH\$XISQ, sample global user exit program 24  
DFH\$XNQE, sample global user exit program 19  
DFH\$XTSE, example program for XTSEREQ exit 877  
DFH\$XZIQ, sample global user exit program 24, 256  
DFH\$ZCAT, sample global user exit program 16  
DFH0CBDC program, write DEFINE commands for  
  COBOL 817  
DFH0CRFC, cross-reference program, COBOL 816  
DFH0FORC, formatting program, COBOL 817  
DFH0GNIT, sample "good night" program 803  
DFHAPIQX macro 384  
DFHAPXPO, XPLINK run-time options program 685  
DFHBRIQX macro 401  
DFHCESD, shutdown assist program 429  
DFHCSDUP, system definition utility program  
  as a batch program  
    EXTRACT command 814  
    link-edit statements for user program 819  
    parameters passed from DFHCSDUP to the user  
    program 815  
    when the user program is invoked 815  
    writing a program for EXTRACT processing 814  
  invocation from a user program 824  
    entry parameters for DFHCSDUP 822  
    introduction 821  
    responsibilities of the user program 824  
  overview 813  
  running under TSO 821  
  sample programs  
    CSD backup utility program 818  
    CSD cross-referencing program 818  
    DB2 formatting program 818

DFHCSDUP, system definition utility program  
(*continued*)

- sample programs (*continued*)
  - DFH\$CRFA 816
  - DFH\$CRFP 816
  - DFH\$FORA 817
  - DFH\$FORP 817
  - DFH0CBDC 817
  - DFH0CRFC 816
  - DFH0FORC 817

DFHDBUEX, CICS-DBCTL interface status program

- communications area 659
- introduction to 659
- sample program 660

DFHDDAPX macro 321, 323, 324, 325, 326, 327, 328, 329, 330

DFHDSATX macro 331

DFHDSRP, distributed routing program

- changing the target region 627, 633, 639, 643
- communications area 645
- differences from dynamic routing program 624
- error handling 628, 634, 640, 644
- invoking on abend 628, 635, 641, 644
- overview 623
- processing considerations 645
- renaming customized version 656
- routing a BTS activity 627
- routing a method request for a CORBA stateless object 634
- routing a method request for an enterprise bean 634
- routing inbound Web service requests 643
- routing non-terminal-related START requests 639
- sample program 657
- when invoked 626, 632, 638, 642

DFHDSSRX macro 331

DFHDUDUX macro 345

DFHDXGHD DSECT 702

DFHDYP, dynamic routing program

- bridge considerations 606
- changing bridge parameters 604
- changing the program name 593, 599
- changing the target region 592, 599
- communications area 607
- error handling 594, 600
- information passed to 591
- invoking on abend 594, 602
- modifying application's communications area 595, 602
- modifying initial terminal data 595
- overview 589
- processing considerations 596, 602
- receiving information from routed DPL request
  - monitoring the output COMMAREA 602
- receiving information from routed transaction
  - monitoring the output COMMAREA 596
  - monitoring the output TIOA 596
- renaming customized version 621
- routing a bridge request 605, 606
- routing a program-link request 600
- routing a transaction 593

DFHDYP, dynamic routing program (*continued*)

- sample program 622
- testing customized version 621
- UOW considerations 597, 603
- when invoked 590, 598

DFHEBURM

- IIO security program 665

DFHEIP, EXEC interface program 436

DFHEJDNX, the distinguished name program for EJB clients 675

DFHEJEP, EJB event program

- actions of the default program 682
- communications area 680
- event codes 681
- overview 679
- sample program 682
- writing your own program 682

DFHISAI, user-replaceable autoinstall program

- communications area 555
- default actions 558
- introduction to 553
- purpose of 553
- supplied definition of 558
- the sample program 557
- when invoked 555

DFHJJCJX macro 419

DFHJVMAT, JVM profile options program 671

DFHJVMAT, JVM program

- available options 672

DFHKEDSX macro 351

DFHLDLDX macro 352

DFHLGPAX macro 360

DFHMCT TYPE=RECORD macro 748

DFHMCTDR, monitoring dictionary DSECT 754

DFHMNMNX macro 361

DFHNET DSECTs 504

DFHNQEDX macro 349

DFHOSD data set 693

DFHPEP, program error program

- communication area for assembler-language programs 441
- source code 440
- writing 439

DFHPGADX, user-replaceable autoinstall program

- customizing 586
- installation of mapsets 581
- introduction to 579
- parameter list at install 583
- sample program 586
- supplied definition of 587
- use of model definitions 580
- when invoked 579

DFHPGAQX macro 366

DFHPGISX macro 366

DFHREST, transaction restart program

- communications area 446
- default program 447
- introduction 445
- transactions suitable for restart 445
- when invoked 445

DFHRMCAL macro 267



DFHSAIQX macro 386, 391  
 DFHSMFDS, SMF header DSECT 750  
 DFHSMMCX macro 392  
 DFHSMSRX macro 397  
 DFHSNEP macro  
   TYPE=DEF3270 500  
   TYPE=DEFILU 501  
   TYPE=ERRPROC 484, 501  
   TYPE=FINAL 501  
   TYPE=INITIAL 483, 500  
   TYPE=USTOR 499  
   TYPE=USTOREND 499  
 DFHSNEP, sample node error program 499  
 DFHSNET macro 503  
   COUNT operand 503  
   ESB structure 503  
   ESBS operand 503  
   NAME operand 503  
   NEBNAME operand 503  
   NEBS operand 503  
   TIME operand 503  
 DFHSTUP, statistics processing program 777  
 DFHTACP, terminal abnormal condition program 450  
   terminal error-handling 449  
 DFHTEP, terminal error program  
   link-edit statements 437  
 DFHTEPM macro  
   examples 463  
   TYPE=ENTRY 462  
   TYPE=ERRPROC 462  
   TYPE=EXIT 462  
   TYPE=FINAL 463  
   TYPE=INITIAL 460  
 DFHTEPT macro  
   examples 469  
   TYPE=BUCKET 468  
   TYPE=FINAL 469  
   TYPE=INITIAL 465  
   TYPE=PERMCODE|ERRCODE 466  
   TYPE=PERMTID 465  
 DFHTRPTX macro 399  
 DFHUEPAR DSECT 7, 274  
 DFHUERTR DSECT 278  
 DFHUEXIT macro 7  
 DFHWOS, overseer module 693  
 DFHWOSM macros  
   FUNC=BUILD 696  
   FUNC=CLOSE 696  
   FUNC=DSECT 697  
   FUNC=JJC 697  
   FUNC=JJS 697  
   FUNC=OPEN 698  
   FUNC=OSCMD 699  
   FUNC=QJJS 697  
   FUNC=READ 699, 701  
   FUNC=TERM 703  
   token values 695  
 DFHXIS, sample global user exit program 20, 140  
 DFHXMCLX macro 405  
 DFHXMIQX macro 414, 418  
 DFHXMSRX macro 403  
 DFHXMIDX macro 406  
 DFHXOPUS  
   IIO security program 665  
 DFHXTENF, sample global user exit program 25  
 DFHXTEP, sample terminal error program 451  
 DFHZATDX, user-replaceable autoinstall program  
   action at delete 525  
   action at install 517  
   communications area 525  
   customizing 528  
   for consoles 535  
   introduction 515  
   sample control program 528  
   source code 527  
   suggestions for use 528  
   used to install shipped terminals 559  
   used to install virtual terminals 567  
 DFHZATDY, user-replaceable autoinstall program  
   communications area 545  
   default actions 550  
   for APPC single-session connections  
     initiated by CINIT 543  
   for parallel-session APPC connections 543  
   for single-session APPC connections  
     initiated by BIND 543  
   introduction to 543  
   purpose of 545  
   supplied definition of 551  
   the sample program 550  
   used to install shipped terminals 559  
   used to install virtual terminals 567  
   when invoked 545  
 DFHZNAC, node abnormal condition program 480  
   action flag settings 868  
   default actions  
     for system sense codes 866  
     for terminal error codes 855  
   execution after XRF takeover 510  
   execution with persistent session support 511  
   execution with VTAM generic resources 512  
   logging facility 494  
   terminal error-handling 486  
 DFHZNEP, node error program  
   link-edit statements 437  
 DFHZNEP, user-replaceable node error program 479  
 DFHZNEPI macros  
   TYPE=ENTRY 509  
   TYPE=FINAL 509  
   TYPE=INITIAL 509  
 dictionary data section, CICS monitoring records 754,  
 755, 762  
 directory domain functions of the XPI 321  
 disabling journals 711  
 dispatcher functions of the XPI 331  
 display function of the overseer program 690  
 distinguished name program for EJB clients,  
   DFHEJDNX 675  
 distributed program link (DPL)  
   dynamic routing of requests  
     changing the program name 599  
     changing the target region 599

- distributed program link (DPL) *(continued)*
  - dynamic routing of requests *(continued)*
    - eligibility for routing 597
    - error handling 600
    - terminating a request 600
    - when the routing program is invoked 598
- distributed routing
  - of BTS activities
    - changing the target region 627
    - eligibility for routing 625
    - error handling 628
    - running the activity locally 627
    - when the routing program is invoked 626
  - of inbound Web service requests
    - changing the target region 643
    - eligibility for routing 641
    - error handling 644
    - running the transaction locally 643
    - when the routing program is invoked 642
  - of method requests for CORBA stateless objects
    - changing the target region 633
    - eligibility for routing 629
    - error handling 634
    - running the method locally 634
    - when the routing program is invoked 632
  - of method requests for enterprise beans
    - changing the target region 633
    - eligibility for routing 629
    - error handling 634
    - running the method locally 634
    - when the routing program is invoked 632
  - of non-terminal-related START requests
    - changing the target region 639
    - eligibility for routing 637
    - error handling 640
    - running the transaction locally 639
    - when the routing program is invoked 638
  - overview 623
  - sample programs 657
  - the user program
    - error handling procedure 628, 634, 640, 644
    - naming of 656
    - parameters 645
    - when invoked 626, 632, 638, 642
- distributed routing of BTS activities
  - eligibility for routing 625
- distributed routing of method requests for enterprise beans
  - eligibility for routing 629
- distributed routing program (DFHDSRP)
  - changing the target region 627, 633, 639, 643
  - communications area 645
  - error handling 628, 634, 640, 644
  - invoking on abend 628, 635, 641, 644
  - processing considerations 645
  - renaming customized version 656
  - routing a BTS activity 627
  - routing a method request for an enterprise bean 634
  - routing a method request for for a CORBA stateless object 634
- distributed routing program (DFHDSRP) *(continued)*
  - routing inbound Web service requests 643
  - routing non-terminal-related START requests 639
  - sample program 657
  - when invoked 626, 632, 638, 642
- distributed routing program, DFHDSRP
  - differences from dynamic routing program 624
  - overview 623
- DSECTPR operand
  - DFHTEPM TYPE=INITIAL 460
- DSRTPGM, system initialization parameter 656
- DTRPGM, system initialization parameter 621
- DTRTRAN, system initialization parameter 592
- dump control functions of the XPI 345
- dynamic allocation sample program (DYNALLOC)
  - flow of control 784
  - help feature 782
  - introduction 781
  - keywords, abbreviation rules 784
  - system programming considerations 784
  - terminal operation 782
  - values 783
- DYNAMIC option 590
- dynamic routing
  - of bridge requests
    - changing parameters 604
    - eligibility for routing 603
    - error handling 605
    - re-invoking 606
    - terminating a request 605
  - of program-link requests
    - changing the program name 599
    - changing the target region 599
    - eligibility for routing 597
    - error handling 600
    - terminating a request 600
    - when the routing program is invoked 598
  - of transactions
    - changing the program name 593
    - changing the target region 592
    - error handling 594
    - information passed to routing program 591
    - overview 590
    - resource definition 590
    - terminating a transaction 593
    - the user program 590
  - overview 589
  - sample programs 622
  - the user program
    - error handling procedure 594, 600
    - naming of 621
    - parameters 607
    - testing of 621
    - when invoked 590, 598
- dynamic routing of bridge requests
  - eligibility for routing 603
- dynamic routing of DPL requests
  - eligibility for routing 597
  - when the routing program is invoked 598
- dynamic routing program (DFHDYP)
  - bridge considerations 606

- dynamic routing program (DFHDYP) *(continued)*
  - changing bridge parameters 604
  - changing the program name 593, 599
  - changing the target region 592, 599
  - communications area 607
  - error handling 594, 600
  - information passed to 591
  - invoking on abend 594, 602
  - modifying application's communications area 595, 602
  - modifying initial terminal data 595
  - overview 589
  - processing considerations 596, 602
  - receiving information from routed DPL request
    - monitoring the output COMMAREA 602
  - receiving information from routed transaction
    - monitoring the output COMMAREA 596
    - monitoring the output TIOA 596
  - renaming customized version 621
  - routing a bridge request 605, 606
  - routing a program-link request 600
  - routing a transaction 593
  - sample program 622
  - testing customized version 621
  - UOW considerations 597, 603
  - when invoked 590, 598
- dynamic transactions 590

## E

- EDF (Execution Diagnostic Facility)
  - with global user exits 6
  - with task-related user exits 270
- EJB event program, DFHEJEP
  - actions of the default program 682
  - communications area 680
  - event codes 681
  - overview 679
  - sample program 682
  - writing your own program 682
- EMP (event-monitoring point) 744
- END\_BROWSE\_PROGRAM function of the XPI 381
- END\_BROWSE\_RESULTS function of the XPI 323
- ENQUEUE 349
- enqueue domain functions of the XPI 349
- enterprise beans
  - writing a distinguished name program for EJB
    - clients 675
- error group index 497, 503
- error groups 482
- error processing
  - in node error program (NEP) 496
  - in terminal error program (TEP) 449
- error status block (ESB) 503
- error status element (ESE) 452, 458
  - DFHTEPT TYPE=PERMCODEIERRCODE 466
- ESB (error status block) 503
- ESBS operand
  - DFHSNET macro 503
- ESE (error status element) 452, 458
  - DFHTEPT TYPE=PERMCODEIERRCODE 466

- ESM (external security manager) 789
- ESMEXITS, system initialization parameter 792
- event-monitoring point (EMP) 744
- exception class monitoring records 743
- exception data section
  - format 764
- EXEC CICS HANDLE command
  - as alternative to node error program 479
- EXEC CICS INQUIRE command
  - for autoinstall 526
- EXEC CICS SET command
  - for autoinstall 526
  - for enabling and disabling journals 711
- EXEC CICS WRITE JOURNALNAME command 711
- EXEC interface program (DFHEIP) 436
- Execution Diagnostic Facility (EDF)
  - with global user exits 6
  - with task-related user exits 270
  - with user-replaceable programs 435
- Exit XTSPTOUT 211
- Exit XTSQRIN 207
- extended recovery facility (XRF)
  - node error program 510
  - overseer program 689
- external security manager (ESM) 789
- EXTRACT command
  - for task-related user exits 304
  - of DFHCSDUP 814

## F

- FEPI
  - journal records
    - prefix area 727
- field connectors, CICS monitoring 762
- field identifiers, CICS monitoring 762
- file control
  - journal records
    - FILE\_CLOSE\_DATA section 723
    - file-close record types 722
    - FLJB 717
    - FLJB\_COMMON\_DATA section 720
    - FLJB\_GENERAL\_DATA section 719
    - FLJB\_WRITE\_DELETE\_DATA section 721
    - read-only record type 718
    - read-update record type 718
    - TIE\_UP\_RECORD\_DATA section 724
    - tie-up record types 724
    - write-add complete record type 718
    - write-add record type 718
    - write-delete record types 721
    - write-update record type 718
  - FILE\_CLOSE\_DATA section, journal records 723
  - FLJB\_COMMON\_DATA section, journal records 720
  - FLJB\_GENERAL\_DATA section, journal records 719
  - FLJB\_WRITE\_DELETE\_DATA section, journal records 721
  - FLJB, file control journal block 717
  - FLUSH\_LDAP\_CACHE function of the XPI 323
  - FREE\_SEARCH\_RESULTS function of the XPI 324
  - FREEMAIN function of the XPI 395

## G

generic resources, VTAM 547  
 node error program 512

GET\_ATTRIBUTE\_VALUE function of the XPI 325

GET\_NEXT\_ATTRIBUTE function of the XPI 326

GET\_NEXT\_ENTRY function of the XPI 327

GET\_NEXT\_PROGRAM function of the XPI 380

GETMAIN function of the XPI 393

global user exits  
 example programs 18  
 for EXEC interface exits 877  
 for mixing API and XPI calls 5, 877  
 for modifying TS requests 221, 877  
 for XFCREQ 94, 98  
 for XFCREQC 94, 98  
 for XICREQ 161, 162  
 for XICREQC 161, 162  
 for XPCREQ 185  
 for XPCREQC 185  
 for XTDEREQ 236  
 for XTDEREQC 236  
 for XTSEREQ 221, 877  
 for XTSEREQC 221, 877

exit points  
 bridge facility creation 38  
 bridge facility deletion 38  
 for 'terminal not known' condition 224  
 in activity keypoint program 32  
 in Application Associated Data 33  
 in BMS 34  
 in CICS Web support 138  
 in data tables management 40  
 in data tables programs 40  
 in DBCTL interface control program 45  
 in DBCTL tracking program 46  
 in dispatcher domain 47  
 in DL/I interface program 48  
 in dump domain 53  
 in enqueue EXEC interface program 60  
 in EXEC interface program 67  
 in file control domain 72  
 in file control EXEC interface program 85, 98  
 in file control file state program 111  
 in file control open/close program 121  
 in file control quiesce receive program 122  
 in file control quiesce send program 124  
 in file control recovery program 126  
 in Front End Programming Interface 137  
 in good-morning message program 138  
 in intersystem communication program 138  
 in interval control EXEC interface program 145  
 in interval control program 143  
 in loader domain 162  
 in log manager domain 164  
 in message domain 168  
 in monitoring domain 172  
 in pipeline domain 174  
 in program control program 175

global user exits (*continued*)  
 exit points (*continued*)  
 in resource management modules 195  
 in resource manager interface program 193  
 in security manager domain 199  
 in statistics domain 202, 776  
 in system recovery program 203  
 in system termination program 206  
 in temporary storage domain 207  
 in temporary storage EXEC interface program 212  
 in terminal allocation program 221  
 in terminal control program 223  
 in transaction manager domain 232  
 in transient data EXEC interface program 236  
 in transient data program 234  
 in user log record recovery program 244  
 in VTAM terminal management program 247  
 in VTAM working-set module 248  
 in XRF request-processing program 263

exit programs  
 addressing implications 4  
 defining, enabling, and disabling 12  
 errors 12  
 global work area 6  
 multiple at one exit 13  
 one at several exits 14  
 parameters passed 7  
 programming interface restrictions 11  
 register conventions 3  
 returning values to CICS 10  
 using CICS services 4  
 using EDF 6

overview 3

sample programs  
 DFH\$APAD 18  
 DFH\$BMXT 18  
 DFH\$DTAD 18  
 DFH\$DTLC 18  
 DFH\$DTRD 18  
 DFH\$FCBF 19  
 DFH\$FCBV 19  
 DFH\$FCLD 20  
 DFH\$ICCN 162  
 DFH\$LGLS 23, 167  
 DFH\$PCEX 16, 188  
 DFH\$PCPI 16  
 DFH\$PCTA 24, 191  
 DFH\$PIEX 24  
 DFH\$REQC 19  
 DFH\$SXP1 171  
 DFH\$SXP2 171  
 DFH\$SXP3 171  
 DFH\$SXP4 171  
 DFH\$SXP5 171  
 DFH\$SXP6 171  
 DFH\$SXPn set 23  
 DFH\$WBEX 21  
 DFH\$WBGA 20  
 DFH\$WBLD 21, 22  
 DFH\$WBPI 20

global user exits *(continued)*  
 sample programs *(continued)*  
 DFH\$WBX1 21  
 DFH\$WBX2 22  
 DFH\$XDRQ 19  
 DFH\$XISQ 24  
 DFH\$XNQE 19, 66  
 DFH\$XZIQ 24  
 DFH\$ZCAT 16  
 DFHXIS 140  
 DFHXTENF 230  
 summary of 15  
 trace table entries 6  
 with storage protection  
 data storage key 11  
 execution key 11  
 GLUEs 3  
 GLUEs, alphabetical list 25  
 GLUEs, functional list 32  
 GMTRAN, system initialization parameter 493  
 GNTRAN, system initialization parameter 801, 805  
 GROUP operand  
 DFHSNEP TYPE=ERRPROC 501

**I**

IIOP  
 DFHEBURM 665  
 DFHXOPUS 665  
 security exit program 663  
 security program 663  
 initialization programs  
 considerations when writing 425  
 INITPARMS, system initialization parameter 16  
 INQ\_APPLICATION\_DATA function of the XPI 384  
 INQUIRE MONITORING DATA function of the XPI 365  
 INQUIRE\_ACCESS function of the XPI 395  
 INQUIRE\_AUTOINSTALL function of the XPI 382  
 INQUIRE\_CONTEXT function of the XPI 401  
 INQUIRE\_CURRENT\_PROGRAM function of the XPI 373  
 INQUIRE\_DTRTRAN function of the XPI 403  
 INQUIRE\_ELEMENT\_LENGTH function of the XPI 396  
 INQUIRE\_MXT function of the XPI 403  
 INQUIRE\_PARAMETERS function of the XPI 360  
 INQUIRE\_PROGRAM function of the XPI 366  
 INQUIRE\_SHORT\_ON\_STORAGE function of the XPI 397  
 INQUIRE\_SYSTEM function of the XPI 386  
 INQUIRE\_TASK\_STORAGE function of the XPI 398  
 INQUIRE\_TCLASS function of the XPI 405  
 INQUIRE\_TRANDEF function of the XPI 406  
 INQUIRE\_TRANSACTION function of the XPI 414  
 interactive logical unit error processor 499  
 intersystem queues  
 controlling the length of  
 using the XISCONA global user exit 138  
 using the XZIQUE global user exit 249  
 INTLU error processor 499

IPCONNns  
 intersystem queues 258  
 XISQUE global user exit  
 for controlling intersystem queues 258  
 IPIC connections, automatic installation of 553  
 ISC over TCP/IP intersystem queues  
 controlling the length of  
 using the XISQUE global user exit 258  
 ISC over TCP/IPCONNns  
 intersystem queues 258  
 XISQUE global user exit  
 for controlling intersystem queues 258  
 ISSUE PASS command 495  
 ISTINCLM entries for automatic installation 835

**J**

job control for sample DFHTEP generation 459  
 journal control label header 729  
 journal module identifiers 737  
 journal record formats  
 caller data, file control 717  
 FEPI prefix 727  
 format 712  
 journal control label header 729  
 label header 730  
 label prefix 730  
 log block header 713  
 new format journal record 714  
 old format 729  
 old format journal record 731  
 start-of-run record 716  
 system header 732  
 system prefix 733  
 terminal control prefix 726  
 user prefix 734  
 journal record, old format 731  
 journal records  
 data section format 742  
 module identifiers 737  
 written to SMF 737  
 journals  
 disabling 711  
 enabling 711  
 reading 711  
 offline 712  
 JVM profile options program, DFHJVMAT 671

**K**

kernel domain functions of the XPI 351

**L**

label header 730  
 label prefix 730  
 LIBRARYDSN option  
 INQUIRE PROGRAM command 370  
 INQUIRE\_CURRENT PROGRAM command 375  
 loader functions of the XPI 352  
 log block header, journal records 713

- log manager functions of the XPI 360
- logical units (LUs)
  - node error program 486
- LOGON mode table, VTAM 833
- LU alias names 523

## M

- MAXERRS operand
  - DFHTEPT TYPE=INITIAL 465
- MAXTIDS operand
  - DFHTEPT TYPE=INITIAL 465
- MCT (monitoring control table)
  - entries for DBCTL 749
  - entries for EMPs 747
- model definitions
  - for autoinstall of APPC connections 543
  - for automatic installation of programs 580
- model terminal support
  - coding entries 517
- MONITOR function of the XPI 362
- monitoring
  - control table (MCT) 747
  - data section format 754
  - DFHMCT entries for DBCTL 749
  - DFHMCTDR, the dictionary DSECT 754
  - DFHSMFDS, SMF header DSECT 750
  - dictionary data section 754, 755, 762
  - event-monitoring point (EMP) 744
  - exception class data 743
  - exception data section 764
  - excluding performance data 748
  - field connectors 762
  - field identifiers 762
  - functions of the XPI 361
  - monitoring control table 747
    - DFHMCT TYPE=RECORD macro 748
  - overview 743
  - passing the data to SMF 743
  - performance class data 743
  - performance data section 761
  - purpose 743
  - record formats 750
  - record types 743
  - SMF 743
  - SMF header 750
  - SMF product section 750
  - transaction resource data section format 765
  - transaction resource data sections 765
- monitoring control table (MCT) 747
- MRO connections
  - intersystem queues 249
  - XZIQUE global user exit
    - for controlling intersystem queues 249
- MVS consoles
  - automatic installation 535
- MVS router exit 789

## N

- NAME operand
  - DFHSNEP TYPE=INITIAL 500
  - DFHSNET macro 503
- national characters
  - uppercase translation 875
- NEB (node error block) 504
- NEBNAME operand
  - DFHSNET macro 503
- NEBS operand
  - DFHSNET macro 503
- NEP (node error program)
  - 3270 unavailable printer 506
  - ACF/VTAM error handling
    - background 480
  - application routing failure 495
  - common subroutine vector table (CSVT) 504
  - communication area 487
  - conventions for registers 502
  - default actions of DFHZNAC
    - for system sense codes 866
    - for terminal error codes 855
  - default node error program 482
  - default transaction-class routine 509
  - DFHNET DSECT 504
  - DFHSNET 503
  - DFHZNAC 486
  - DFHZNAC action flag settings 868
  - DFHZNAC logging facility 494
  - DFHZNAC/DFHZNEP interface 480
  - DFHZNEP 480, 486
  - DFHZNEPI interface module 508
  - DFHZNEPI macros 508
  - DFHZNEPI TYPE=INITIAL 509
  - DSECTs 504
  - error groups 482
  - error status blocks 504
  - error table header 504
  - in an XRF environment 510
    - changing the recovery message 512
    - changing the recovery notification 511
    - changing the recovery transaction 512
  - multiple NEPs 485
  - NEPCLASS 485
  - NET generation 482
  - node abnormal condition program 486
  - node error block, format 498
  - node error blocks 504
  - node error table 497
    - format 498
    - generation 482
  - reasons for writing your own 480
  - routing considerations 486
  - sample 482, 496
    - addressability 497
    - coding description 483
    - common subroutine vector table (CSVT) 497
    - compatibility with sample TEP 496
    - components 496
    - conditions 485
    - CSVT (common subroutine vector table) 497

NEP (node error program) *(continued)*  
 sample *(continued)*  
 DFHSNEP TYPE=INITIAL macro 500  
 DFHSNEP TYPE=USTOR macro 499  
 DFHSNEP TYPE=USTOREND macro 499  
 error processor vector table (EPVT) 497, 501  
 error processors for INTLU, DFHSNEP  
 TYPE=DEFILU 501  
 error processors, DFHSNEP  
 TYPE=DEF3270 500  
 error status information 497  
 generating by DFHSNEP 499  
 node error table 497  
 optional common subroutines 498  
 optional error processor for INTLU 499  
 optional error processors for 3270 498  
 routing mechanism (ACF/VTAM) 497  
 session failures 507  
 TERMERR condition 479  
 terminal control program (ACF/VTAM section) 486  
 user-supplied error processors, DFHSNEP  
 TYPE=ERRPROC 501  
 user-written 505  
 addressability 506  
 restrictions on use 505  
 user-written error processors 501  
 when abnormal condition occurs 486  
 with persistent session support 511  
 with VTAM generic resources 512  
 writing overview 481  
 NEPCLAS operand  
 DFHZNEPI TYPE=ENTRY 509  
 NEPCCLASS operand  
 for CEDA 485  
 NEPNAME operand  
 DFHZNEPI TYPE=ENTRY 509  
 NET (node error table) 482  
 NETNAME operand  
 DFHSNEP TYPE=INITIAL 500  
 node abnormal condition program (NACP) 486  
 node error block (NEB) 504  
 node error handler (CSNE transaction) 480  
 node error program (NEP)  
 3270 unavailable printer 506  
 ACF/VTAM error handling  
 background 480  
 application routing failure 495  
 common subroutine vector table (CSVTV) 504  
 communication area 487  
 conventions for registers 502  
 default actions of DFHZNAC  
 for system sense codes 866  
 for terminal error codes 855  
 default node error program 482  
 default transaction-class routine 509  
 DFHNET DSECT 504  
 DFHSNET 503  
 DFHZNAC 486  
 DFHZNAC action flag settings 868  
 DFHZNAC logging facility 494  
 DFHZNAC/DFHZNEP interface 480  
 node error program (NEP) *(continued)*  
 DFHZNEP 480, 486  
 DFHZNEPI interface module 508  
 DFHZNEPI macros 508  
 DFHZNEPI TYPE=INITIAL 509  
 DSECTs 504  
 error groups 482  
 error status blocks 504  
 error table header 504  
 in an XRF environment 510  
 changing the recovery message 512  
 changing the recovery notification 511  
 changing the recovery transaction 512  
 multiple NEPs 485  
 NEPCCLASS 485  
 NET generation 482  
 node abnormal condition program 486  
 node error block, format 498  
 node error blocks 504  
 node error table 497  
 format 498  
 generation 482  
 reasons for writing your own 480  
 routing considerations 486  
 sample 482, 496  
 addressability 497  
 coding description 483  
 common subroutine vector table (CSVTV) 497  
 compatibility with sample TEP 496  
 components 496  
 conditions 485  
 CSVTV (common subroutine vector table) 497  
 DFHSNEP TYPE=INITIAL macro 500  
 DFHSNEP TYPE=USTOR macro 499  
 DFHSNEP TYPE=USTOREND macro 499  
 error processor vector table (EPVT) 497, 501  
 error processors for INTLU, DFHSNEP  
 TYPE=DEFILU 501  
 error processors, DFHSNEP  
 TYPE=DEF3270 500  
 error status information 497  
 generating by DFHSNEP 499  
 node error table 497  
 optional common subroutines 498  
 optional error processor for INTLU 499  
 optional error processors for 3270 498  
 routing mechanism (ACF/VTAM) 497  
 session failures 507  
 TERMERR condition 479  
 terminal control program (ACF/VTAM section) 486  
 user-supplied error processors, DFHSNEP  
 TYPE=ERRPROC 501  
 user-written 505  
 addressability 506  
 restrictions on use 505  
 user-written error processors 501  
 when abnormal condition occurs 486  
 with persistent session support 511  
 with VTAM generic resources 512  
 writing overview 481  
 node error table (NET) 482

nonpurgeable task 472  
notation, syntax xviii

## O

OPTIONS operand  
  DFHTEPM TYPE=INITIAL 460  
  DFHTEPT TYPE=INITIAL 465  
overseer program  
  customizing the sample program 703  
  including the CEBT command 704  
  loop or wait detection in the active 705  
DFH\$AXRO 693  
DFHOSD data set 693  
DFHWOSM macros 695  
  FUNC=BUILD 696  
  FUNC=CLOSE 696  
  FUNC=DSECT 697  
  FUNC=JJC 697  
  FUNC=JJS 697  
  FUNC=OPEN 698  
  FUNC=OSCMD 699  
  FUNC=QJJS 697  
  FUNC=READ 699  
  FUNC=TERM 703  
display function 690  
interface with CICS 693  
module DFHWOS 693  
opening CAVM data sets dynamically 692  
restart-in-place function 691  
  enabling and disabling 691  
  rules governing restart in place 692

## P

PEP (program error program)  
  communication area for assembler-language  
  programs 441  
  source code 440  
  writing 439  
performance class monitoring records 743  
performance data section  
  format 761  
persistent session support  
  node error program 511  
PGAICTLG, system initialization parameter 582  
PGAEXIT, system initialization parameter 582  
PGAIPGM, system initialization parameter 426, 582  
PLT programs 430  
PLTPI programs  
  first-phase 425  
  general considerations 429  
  introduction 425  
  second phase 426  
PLTSD, system initialization parameter 425  
PLTSD programs  
  first phase 428  
  general considerations 429  
  introduction 428  
  second phase 428  
PLTSD, system initialization parameter 428

PRINT operand  
  DFHTEPM TYPE=INITIAL 461  
processing output from CICS statistics 777  
program error program (PEP)  
  communication area for assembler-language  
  programs 441  
  source code 440  
  writing 439  
program list table (PLT) programs  
  general considerations 429  
  PLTPI programs  
    first-phase 425  
    introduction 425  
    second phase 426  
  PLTSD programs  
    first phase 428  
    introduction 428  
    second phase 428  
  with storage protection  
    data storage key 431  
    execution key 430  
program management functions of the XPI 366  
programmable interface to RDO transactions 809  
programs, automatic installation of 579  
PSERVIC values for automatic installation 840

## Q

queues for intersystem sessions  
  controlling the length of  
    using the XISCONA global user exit 138  
    using the XISQUE global user exit 258  
    using the XZIQUE global user exit 249

## R

RACROUTE macros 796  
RDO transactions  
  EXEC CICS LINK to DFHEDAP 809  
  programmable interface to 809  
reading DBCTL information from the CAVM data  
sets 702  
recovery and restart  
  node error program (DFHZNEP) 479  
  program error program (PEP) 439  
  routing mechanism (ACF/VTAM) 497  
recursive retry routine, in DFHTEP  
  example 476  
RELEASE PROGRAM function of the XPI 358  
RENTPGM, system initialization parameter 353, 376  
resource definition online transactions  
  EXEC CICS LINK to DFHEDAP 809  
  programmable interface to 809  
resource manager interface (RMI) 267  
restart-in-place function of the overseer program 691  
RESUME function of the XPI 339  
RMI (resource manager interface) 267  
RMTRAN, system initialization parameter 512  
routing mechanism, VTAM 497



## S

### sample programs

- “good night” transaction (DFH0GNIT) 803
- CICS–DBCTL interface status program (DFHDBUEX) 660
- for automatic installation of APPC connections 550
- for automatic installation of IPCONNs 557
- for automatic installation of programs 586
- for automatic installation of terminals 527
- for distributed routing 657
- for dynamic allocation (DYNALLOC) 781
- for dynamic routing 622
- for global user exits
  - DFH\$APAD, for the XAPADMG exit 18
  - DFH\$BMXT, for the XBMIN and XBMOUT exits 18
  - DFH\$DTAD, for the XDTAD exit 18
  - DFH\$DTLC, for the XDTLC exit 18
  - DFH\$DTRD, for the XDTRD exit 18
  - DFH\$FCBF, for the XFCBAIL exit 19
  - DFH\$FCBF, for the XFCFAIL exit 130
  - DFH\$FCBV, for the XFCBOVER exit 19, 134
  - DFH\$FCLD, for the XFCLDEL exit 20, 136
  - DFH\$ICCN 23
  - DFH\$ICCN, for the XICEREQ exit 23
  - DFH\$LGLS, for the XLGSTRM dexit 23
  - DFH\$LGLS, for the XLGSTRM exit 167
  - DFH\$PCEX, for the XPCFTCH exit 16, 188
  - DFH\$PCPI, description of 16
  - DFH\$PCTA, for the XPCTA exit 24, 191
  - DFH\$PIEX, for the XWSPRROO exit 24
  - DFH\$SXPN, for the XMEOUT exit 23, 171
  - DFH\$WBEX, for the XWBOPEN exit 21
  - DFH\$WBGA, for the XWBOPEN exit 20
  - DFH\$WBPI, for the XWBAUTH exit 20
  - DFH\$WBPI, for the XWBOPEN exit 20
  - DFH\$WBX1, for the XWBAUTH exit 21
  - DFH\$WBX2, for the XWBAUTH exit 22
  - DFH\$XDRQ, for the dump domain exit 19
  - DFH\$XISQ, for the XISQUE exit 24
  - DFH\$XNQE, for the XNQEREQ and XNQEREQC exits 19
  - DFH\$XZIQ, for the XZIQUE exit 24, 256
  - DFH\$ZCAT, for the XZCATT exit 16
  - DFHXIS 20
  - DFHXIS, for the XISCONA exit 20, 140
  - DFHXTENF, for the XALTENF exit 25, 230
  - DFHXTENF, for the XICTENF exit 25
- for the system definition utility program, DFHCSDUP
  - CSD backup utility program 818
  - CSD cross-referencing program 818
  - DB2 formatting program 818
  - DFH\$CRFA 816
  - DFH\$CRFP 816
  - DFH\$FORA 817
  - DFH\$FORP 817
  - DFH0CBDC 817
  - DFH0CRFC 816
  - DFH0FORC 817
- node error program (DFHSNEP) 496
- program error program (DFHPEP) 443

### sample programs (continued)

- terminal error program (DFHXTEP) 451
- transaction restart program (DFHREST) 447
- transient data write-to-terminal program (DFH\$TDWT) 873
- schedule flag word 287
- SEARCH\_LDAP function of the XPI 328
- security
  - interface to external manager 789
  - MVS router 789
  - MVS router exit 789
  - RACROUTE macros 796
  - system authorization facility (SAF) 789
  - the CICSESM interface 789
- session failures, user actions 507
- SET\_AUTOINSTALL function of the XPI 382
- SET\_PARAMETERS function of the XPI 361
- SET\_PROGRAM function of the XPI 375
- SET\_SYSTEM function of the XPI 391
- SET\_TRANSACTION function of the XPI 418
- shipped terminals, automatic installation of 559
- shutdown (PLTSD) programs
  - considerations when writing 428
- shutdown assist program, DFHCESD 429
- shutdown assist transaction 429
- SMF (system management facility) 743
  - header 738, 750, 771
  - product section 740, 771
- specifying processing at EMPs
  - MCT entries for DBCTL 749
- SSL
  - secure sockets layer and IIOp 665
- START\_BROWSE\_PROGRAM function of the XPI 379
- START\_BROWSE\_RESULTS function of the XPI 329
- START\_PURGE\_PROTECTION function of the XPI 351
- start-of-run record, journal records 716
- state data access functions of the XPI 384
- statistics
  - data section format 773
  - global user exit 776
  - overview 769
  - processing output from 777
  - purpose 769
  - record formats 771
  - record types 769
  - SMF header 771
  - SMF product section 771
  - writing a program to collect CICS statistics 769
- STOP\_PURGE\_PROTECTION function of the XPI 351
- storage control functions of the XPI 392, 397
- storage protection facility
  - with global user exit programs 11
  - with PLT programs 430
  - with task-related user exit programs 290
  - with user-replaceable programs 437
- stub program, for task-related user exits 267, 269
- SUSPEND function of the XPI 335
- SWITCH\_SUBSPACE function of the XPI 399
- syncpoint management
  - syncpoint manager parameters 279

- syntax notation xviii
  - system autoinstall 581
  - system definition utility program (DFHCSDUP)
    - as a batch program
      - EXTRACT command 814
      - link-edit statements for user program 819
      - parameters passed from DFHCSDUP to the user program 815
      - when the user program is invoked 815
      - writing a program for EXTRACT processing 814
    - invocation from a user program
      - entry parameters for DFHCSDUP 822
      - introduction 821
      - responsibilities of the user program 824
      - user exits in DFHCSDUP 824
    - overview 813
    - running under TSO 821
    - sample programs
      - CSD backup utility program 818
      - CSD cross-referencing program 818
      - DB2 formatting program 818
      - DFH\$CRFA 816
      - DFH\$CRFP 816
      - DFH\$FORA 817
      - DFH\$FORP 817
      - DFH0CBDC 817
      - DFH0CRFC 816
      - DFH0FORC 817
  - SYSTEM DUMP function of the XPI 345
  - system header, journal records 732
  - system initialization parameters
    - AIEXIT 516, 544
    - AILDELAY 195
    - AIRDELAY 511
    - CLSDSTP 495
    - DSRTPGM 656
    - DTRPGM 621
    - DTRTRAN 592
    - ESMEXITS 792
    - GMTRAN 493
    - GNTRAN 801, 805
    - INITPARMS 16
    - PGAICTLG 582
    - PGAEXIT 582
    - PGAIPGM 426, 582
    - PLTPI 425
    - PLTSD 428
    - RENTPGM 353, 376
    - RMTRAN 512
    - TBEXITS 12, 126, 246
  - system management facility (SMF) 743
    - header 738, 750
    - product section 740, 750
  - system prefix, journal records 733
  - system-defined event-monitoring point 744
- T**
  - TACLE (terminal abnormal condition line entry)
    - address contents 473
    - DSECT, format description 474
  - TACLE (terminal abnormal condition line entry)
    - (continued)
      - terminal error program 451
  - task manager parameters in task-related user exits 282
  - task-related user exits 267
    - adapter
      - installing and withdrawing 302
      - responses to the caller 289
      - structure and components 267
    - addressability of the parameter list 273
    - addressing mode implications 289
    - administration 268, 302
    - application program parameters 279
    - caller parameter lists 279
    - CEDA 303
    - CICS termination calls 298
      - limitations 298
      - sample code 299
      - use of DFHEIENT 299
    - DFHEIENT macros 291
    - DFHUEPAR DSECT 273
    - DFHUERTR, function definition 278
    - DFHUEXIT TYPE=RM macro 273
    - EDF 270
    - enabling and disabling
      - EXEC CICS DISABLE command 304
      - EXEC CICS ENABLE command 304
    - EXTRACT command 304
    - global work area 292, 304
    - local work area 293
    - parameter lists 273
    - PPT entries 303
    - protocols
      - read-only 294
      - single-update 294
    - recovery considerations 293
    - sample code for CICS termination call 299
    - sample code for syncpoint manager calls 295
    - schedule flag word 287
    - SPI parameters 279
    - stub program 267, 269
      - ename 269
      - statname 269
    - syncpoint manager calls 293
      - backing out changes 297
      - committing changes 297
      - restart resynchronization 297
      - sample pseudocode 295
    - syncpoint manager parameters 279
    - table entries 303
    - task manager calls 297
      - limitations 298
    - task manager parameters 282
    - UEPCALAM, address of the caller's AMODE
      - indication byte 276
    - UEPEIB, address of EIB 275
    - UEPEXN, address of function definition 274
    - UEPFLAGS, address of schedule flag word 275
    - UEPGAA, address of global work area 274
    - UEPGAL, length of global work area 274

task-related user exits (*continued*)

- UEPHMSA, address of register save area 275
- UEPPBTOK, address of performance block token 277
- UEPRMQUA, address of the resource manager qualifier name 276
- UEPRMSTK, address of the kernel stack entry 275
- UEPSECBLK, address of a fullword addressing the user security block 275
- UEPSECFLG, address of the user security flag 275
- UEPSYNCA, address of the single-update indication byte 276
- UEPTAA, address of local work area 275
- UEPTAL, length of local work area 275
- UEPTIND, address of the caller's task indicators 276
- UEPUOWDS, address of the APPC identifier 275
- UEPURID, address of unit of recovery identifier 275
- UERTFGP, function group indicator 278
- UERTFID, caller identifier 278
- using CICS commands 291
- using EDF 301
- with storage protection
  - data storage key 290, 431
  - execution key 290
- work areas 292

TBEXITS, system initialization parameter 12, 126, 246

TCP (terminal control program)

- ACF/VTAM section 486
- TACLE (terminal abnormal condition line entry) 450

TEB (terminal error block) 452

templates, for autoinstall of APPC connections 544, 553

TEP (terminal error program)

- abnormal conditions 449
- CICS components 449
- communication area 451
  - address contents 471
- default table 453
- define terminal error blocks
  - tables, DFHTEPT TYPE=PERMTID 465
- DFHTEP recursive retry routine 475
  - example 476
  - system count (TCTTENI) 476
  - user field a (PCISAVE) 475
  - user field b (PCICNT) 475
- DFHTEP tables 464
- DFHTEPM TYPE=ENTRY 462
- DFHTEPM TYPE=EXIT 462
- DFHTEPT TYPE=PERMCODEIERRCODE 466
- error processor source 462
- error table 452
- generating 458
- job control for sample DFHTEP generation 459
- replace error processors, DFHTEPM TYPE=ERRPROC 462
- sample
  - action flag names 457
  - common subroutines 455
  - components 451
  - DECB information 458

TEP (terminal error program) (*continued*)

- sample (*continued*)
  - DECB operand 458
  - DFHTEPM TYPE=INITIAL 459
  - entry and initialization 454
  - error processing execution 454
  - error processor selection 454
  - error status element (ESE) 452
  - ESE information 458
  - exit 455
  - generate sample module 459
  - messages 456
  - overview 454
  - TACLE information 458
  - terminal error block (TEB) 452
  - terminal identification and error-code lookup 454
- tables
  - default threshold count limits 468
  - DFHTEPT macro examples 469
  - DFHTEPT TYPE=BUCKET 468
  - DFHTEPT TYPE=INITIAL 465
- terminal abnormal condition line entry (TACLE) 451
- user-written program
  - abend-transaction bit 472
  - abnormal conditions 470
  - abort write bit 472
  - address contents of communication area 471
  - address contents of TACLE 473
  - dummy terminal indicator 472
  - example 475
  - format description of TACLE DSECT 474
  - nonpurgeable task 472

TERMERR condition 479

terminal abnormal condition line entry (TACLE) 451

terminal abnormal condition program (DFHTACP) 450

terminal control

- journal records
  - prefix area 726

terminal error block (TEB) 452

terminal error program (TEP)

- abnormal conditions 449
- CICS components 449
- communication area 451
  - address contents 471
- default table 453
- define terminal error blocks
  - tables, DFHTEPT TYPE=PERMTID 465
- DFHTEP recursive retry routine 475
  - example 476
  - system count (TCTTENI) 476
  - user field a (PCISAVE) 475
  - user field b (PCICNT) 475
- DFHTEP tables 464
- DFHTEPM TYPE=ENTRY 462
- DFHTEPM TYPE=EXIT 462
- DFHTEPT TYPE=PERMCODEIERRCODE 466
- error processor source 462
- error table 452
- generating 458
- job control for sample DFHTEP generation 459

terminal error program (TEP) *(continued)*  
 replace error processors, DFHTEPM  
 TYPE=ERRPROC 462  
 sample  
 action flag names 457  
 common subroutines 455  
 components 451  
 DECB information 458  
 DECB operand 458  
 DFHTEPM TYPE=INITIAL 459  
 entry and initialization 454  
 error processing execution 454  
 error processor selection 454  
 error status element (ESE) 452  
 ESE information 458  
 exit 455  
 generate sample module 459  
 messages 456  
 overview 454  
 TACLE information 458  
 terminal error block (TEB) 452  
 terminal identification and error-code lookup 454

tables  
 default threshold count limits 468  
 DFHTEPT macro examples 469  
 DFHTEPT TYPE=BUCKET 468  
 DFHTEPT TYPE=INITIAL 465

terminal abnormal condition line entry (TACLE) 451

user-written program  
 abend-transaction bit 472  
 abnormal conditions 470  
 abort write bit 472  
 address contents of communication area 471  
 address contents of TACLE 473  
 dummy terminal indicator 472  
 example 475  
 format description of TACLE DSECT 474  
 nonpurgeable task 472

terminal identification and error-code lookup 454

terminals, automatic installation 515  
 VTAM dynamic LU aliases 523

threadsafe XPI commands 893

TIE\_UP\_RECORD\_DATA section, journal records 724

TIME operand  
 DFHSNET macro 503  
 of DFHTEPT TYPE=PERMCODEIERRCODE  
 macro 467

trace control functions of the XPI 399

trace table entries, global user exit interface 6

TRACE\_PUT function of the XPI 400

transaction abends  
 program error program (PEP) 439

TRANSACTION DUMP function of the XPI 347

transaction management functions of the XPI 401

transaction resource data section format 765

transaction restart program (DFHREST) 445  
 communications area 446  
 default program 447  
 introduction 445  
 transactions suitable for restart 445  
 when invoked 445

transaction-class error-handling routine 487, 509

transient data write-to-terminal program  
 (DFH\$TDWT) 873

TRMIDNT operand  
 DFHTEPT TYPE=PERMTID 466

TSO  
 DFHCSDUP 821

## U

UNBIND\_LDAP function of the XPI 330

uppercase translation  
 of national characters 875

user event-monitoring points 744

user exits  
 in DFHCSDUP 824  
 task-related 267

User exits  
 global 3

user journaling functions of the XPI 419

user prefix, journal records 734

user-replaceable programs 437  
 3270 bridge exit 661  
 assembling and link-editing 436  
 DBCTL interface status program (DFHDBUEX) 659  
 distinguished name program 675  
 distributed routing program (DFHDSRP) 623  
 dynamic routing program (DFHDYP) 589  
 EJB event program (DFHEJEP) 679  
 for automatic installation of APPC connections  
 (DFHZATDY) 543  
 for automatic installation of consoles  
 (DFHZATDX) 535  
 for automatic installation of IPIC connections  
 (DFHISAIP) 553  
 for automatic installation of programs  
 (DFHPGADX) 579  
 for automatic installation of shipped terminals  
 DFHZATDX 559  
 DFHZATDY 559  
 for automatic installation of terminals  
 (DFHZATDX) 515  
 for automatic installation of virtual terminals  
 DFHZATDX 567  
 DFHZATDY 567  
 general rules 435  
 IIOF security program 663  
 JVM profile options program (DFHJVMAT) 671  
 node error program (DFHZNEP) 479  
 program error program (DFHPEP) 439  
 rewriting 435  
 terminal error program (DFHTEP) 449  
 testing with EDF 435  
 transaction restart program (DFHREST) 445  
 with storage protection  
 data storage key 438  
 execution key 437  
 XPLINK run-time options program  
 (DFHAPXPO) 685  
 user-supplied error processors, DFHSNEP  
 TYPE=ERRPROC 501

user-written node error programs 505  
utility programs  
    shutdown assist, DFHCESD 429

## V

virtual terminals, automatic installation of 567  
VTAM dynamic LU alias 523

## W

work areas in task-related user exits 292  
WRITE JOURNAL DATA function of the XPI 419

## X

XALCAID, global user exit 221  
XALTENF, global user exit 226  
XAPADMGR, global user exit 33  
XBMIN, global user exit 35  
XBMOU, global user exit 35  
XDLIPOST, global user exit 51  
XDLIPRE, global user exit 49  
XDSAWT, global user exit 48  
XDSBWT, global user exit 47  
XDTAD, global user exit 43  
XDTLC, global user exit 44  
XDTRD, global user exit 41  
XDUCLSE, global user exit 59  
XDUOUT, global user exit 59  
XDUREQ, global user exit 53  
XDUREQC, global user exit 56  
XEIIN, global user exit 69  
XEIOUT, global user exit 71  
XEISPIN, global user exit 70  
XEISPOUT, global user exit 71  
XFAINTU, global user exit 38  
XFCAREQ, global user exit  
    description 98  
    parameter list and return codes 99  
XFCAREQC, global user exit  
    description 98  
    parameter list and return codes 100  
XFCBFAIL, global user exit 127  
XFCBOUT, global user exit 132  
XFCBOVER, global user exit 132, 133  
XFCFAIL, global user exit  
    DFH\$FCBF sample program 130  
XFCFRIN, global user exit  
    description 72  
    parameter list and return codes 74  
XFCFROUT, global user exit  
    description 73  
    parameter list and return codes 80  
XFCLDEL, global user exit 135  
XFCNREC, global user exit  
    description 121  
XFCQUIS, global user exit  
    description 124  
XFCREQ, global user exit  
    command parameter structure 87

XFCREQ, global user exit (*continued*)  
    description 85  
    example of use 94  
    parameter list and return codes 95  
    UEPCLPS parameter 87  
XFCREQC, global user exit  
    command parameter structure 87  
    description 85  
    example of use 94  
    parameter list and return codes 96  
    UEPCLPS parameter 87  
XFCRSREQ, global user exit 112  
XFCRSREQC, global user exit 116  
XFCVSDS, global user exit  
    description 122  
XGMTEXT, global user exit 138  
XICEREQ, global user exit  
    command parameter structure 151  
    example of use 161  
    parameter list and return codes 146  
    UEPCLPS parameter 152  
XICEREQC, global user exit  
    command parameter structure 151  
    example of use 161  
    parameter list and return codes 149  
    UEPCLPS parameter 152  
XICERES, global user exit  
    checking the availability of resources on the target  
        region 640  
    parameter list and return codes 148  
XICEXP, global user exit 144  
XICREQ, global user exit 143  
XICTENF, global user exit 228  
XISCONA, global user exit 138, 140  
XISLCLQ, global user exit 142  
XISQUE, global user exit 258  
    designing the exit program 262  
    how to use 260  
    overview 258  
    when invoked 258  
XLDELETE, global user exit 163  
XLDLOAD, global user exit 163  
XLGSTRM, global user exit 164  
XMEOUT, global user exit 169  
XMNOUT, global user exit 172  
XNQEREQ, global user exit 60  
    command parameter structure 63  
    UEPCLPS parameter 63  
XNQEREQC, global user exit 61  
    command parameter structure 63  
    UEPCLPS parameter 63  
XPCABND, global user exit 192  
XPCERES, global user exit  
    checking the availability of resources on the target  
        region 601, 605  
    description 176  
    parameter list and return codes 178  
XPCFTCH, global user exit 186  
XPCHAIR, global user exit 189  
XPCREQ, global user exit  
    command parameter structure 181

XPCREQ, global user exit *(continued)*  
 description 175  
 example of use 185  
 parameter list and return codes 177  
 UEPCLPS parameter 181

XPCREQC, global user exit  
 command parameter structure 181  
 description 177  
 example of use 185  
 parameter list and return codes 179  
 UEPCLPS parameter 181

XPCTA, global user exit 190

XPI (exit programming interface)  
 directory domain functions  
 BIND\_LDAP 321  
 END\_BROWSE\_RESULTS 323  
 FLUSH\_LDAP\_CACHE 323  
 FREE\_SEARCH\_RESULTS 324  
 GET\_ATTRIBUTE\_VALUE 325  
 GET\_NEXT\_ATTRIBUTE 326  
 GET\_NEXT\_ENTRY 327  
 SEARCH\_LDAP 328  
 START\_BROWSE\_RESULTS 329  
 UNBIND\_LDAP 330

dispatcher functions  
 ADD SUSPEND 334  
 CHANGE PRIORITY 344  
 DELETE SUSPEND 340  
 RESUME 339  
 SUSPEND 335  
 WAIT\_MVS 340

dump control functions  
 SYSTEM DUMP 345  
 TRANSACTION DUMP 347

enqueue domain functions  
 DEQUEUE 350  
 ENQUEUE 349

format of an XPI call 308

journaling function  
 WRITE JOURNAL DATA 419

kernel domain functions  
 START\_PURGE\_PROTECTION 351  
 STOP\_PURGE\_PROTECTION 351

loader functions  
 ACQUIRE PROGRAM 356  
 DEFINE PROGRAM 353  
 DELETE PROGRAM 359  
 RELEASE PROGRAM 358

log manager functions  
 INQUIRE\_PARAMETERS 360  
 SET\_PARAMETERS 361

mixing API and XPI calls 5, 877

monitoring functions  
 INQUIRE MONITORING DATA 365  
 MONITOR 362

overview 305

program management functions  
 END\_BROWSE\_PROGRAM 381  
 GET\_NEXT\_PROGRAM 380  
 INQUIRE\_AUTOINSTALL 382  
 INQUIRE\_CURRENT\_PROGRAM 373

XPI (exit programming interface) *(continued)*  
 program management functions *(continued)*  
 INQUIRE\_PROGRAM 366  
 SET\_AUTOINSTALL 382  
 SET\_PROGRAM 375  
 START\_BROWSE\_PROGRAM 379

programming examples 313, 877

state data access functions  
 INQ\_APPLICATION\_DATA 384  
 INQUIRE\_SYSTEM 386  
 SET\_SYSTEM 391

storage control functions  
 FREEMAIN 395  
 GETMAIN 393  
 INQUIRE\_ACCESS 395  
 INQUIRE\_ELEMENT\_LENGTH 396  
 INQUIRE\_SHORT\_ON\_STORAGE 397  
 INQUIRE\_TASK\_STORAGE 398  
 SWITCH\_SUBSPACE 399

threadsafe commands 893

trace control function  
 TRACE\_PUT 400

transaction management functions  
 INQUIRE\_CONTEXT 401  
 INQUIRE\_DTRTRAN 403  
 INQUIRE\_MXT 403  
 INQUIRE\_TCLASS 405  
 INQUIRE\_TRANDEF 406  
 INQUIRE\_TRANSACTION 414  
 SET\_TRANSACTION 418

XPLINK run-time options program, DFHAPXPO 685

XRCINIT, global user exit 246

XRCINPT, global user exit 246

XRF (extended recovery facility)  
 node error program 510  
 overseer program 689

XRF overseer program  
 customizing the sample program 703  
 including the CEBT command 704  
 loop or wait detection in the active 705

DFH\$AXRO 693

DFHOSD data set 693

DFHWOSM macros 695  
 FUNC=BUILD 696  
 FUNC=CLOSE 696  
 FUNC=DSECT 697  
 FUNC=JJC 697  
 FUNC=JJS 697  
 FUNC=OPEN 698  
 FUNC=OSCMD 699  
 FUNC=QJJS 697  
 FUNC=READ 699  
 FUNC=TERM 703

display function 690

interface with CICS 693

module DFHWOS 693

opening CAVM data sets dynamically 692

restart-in-place function 691  
 enabling and disabling 691  
 rules governing restart in place 692

XRMIOUT, global user exit 194

- XRMMI, global user exit 193
- XRSINDI, global user exit 196
- XSNEEX, global user exit 201
- XSNOFF, global user exit 200
- XSNON, global user exit 199
- XSRAB, global user exit 203
- XSTERM, global user exit 206
- XSTOUT, global user exit 202, 776
- XSZARQ, global user exit 137
- XSZBRQ, global user exit 137
- XTCATT, global user exit 224
- XTCIN, global user exit 223
- XTCOUT, global user exit 223
- XTDEREQ, global user exit
  - command parameter structure 239
  - parameter list and return codes 237
  - UEPCLPS parameter 240
- XTDEREQC, global user exit
  - command parameter structure 239
  - parameter list and return codes 238
  - UEPCLPS parameter 240
- XTDIN, global user exit 234
- XTDOUT, global user exit 235
- XTDREQ, global user exit 234
- XTSEREQ, global user exit 213
  - command parameter structure 215
  - example program 221, 877
  - UEPCLPS parameter 215
- XTSEREQC, global user exit 214
  - command parameter structure 215
  - example program 221, 877
  - UEPCLPS parameter 215
- XTSPTIN global user exit 210
- XTSQROUT, global user exit 208
- XWBAUTH, global user exit 138
- XWBOPEN, global user exit 138
- XWBSNDO, global user exit 138
- XWSPRROO, global user exit 174
- XXDFA, global user exit 45
- XXDFB, global user exit 46
- XXDTO, global user exit 46
- XXMATT, global user exit 232
- XXRSTAT, global user exit 264
- XZCATT, global user exit 247
- XZCIN, global user exit 248
- XZCOUT, global user exit 248
- XZCOUT1, global user exit 249
- XZIQUE, global user exit 249, 253
  - designing your exit program 256
  - how to use 250
  - interaction with XISCONA 250
  - overview 249
  - the sample program, DFH\$XZIQ 256
  - using IRC/ISC statistics 256
  - when invoked 250





---

## Notices

This information was developed for products and services offered in the U.S.A. IBM may not offer the products, services, or features discussed in this document in other countries. Consult your local IBM representative for information on the products and services currently available in your area. Any reference to an IBM product, program, or service is not intended to state or imply that only that IBM product, program, or service may be used. Any functionally equivalent product, program, or service that does not infringe any IBM intellectual property right may be used instead. However, it is the user's responsibility to evaluate and verify the operation of any non-IBM product, program, or service.

IBM may have patents or pending patent applications covering subject matter described in this document. The furnishing of this document does not give you any license to these patents. You can send license inquiries, in writing, to:

IBM Director of Licensing  
IBM Corporation  
North Castle Drive  
Armonk, NY 10504-1785  
U.S.A.

For license inquiries regarding double-byte (DBCS) information, contact the IBM Intellectual Property Department in your country or send inquiries, in writing, to:

IBM World Trade Asia Corporation  
Licensing  
2-31 Roppongi 3-chome, Minato-ku  
Tokyo 106, Japan

**The following paragraph does not apply in the United Kingdom or any other country where such provisions are inconsistent with local law:**

INTERNATIONAL BUSINESS MACHINES CORPORATION PROVIDES THIS PUBLICATION "AS IS" WITHOUT WARRANTY OF ANY KIND, EITHER EXPRESS OR IMPLIED, INCLUDING, BUT NOT LIMITED TO, THE IMPLIED WARRANTIES OF NON-INFRINGEMENT, MERCHANTABILITY, OR FITNESS FOR A PARTICULAR PURPOSE. Some states do not allow disclaimer of express or implied warranties in certain transactions, therefore this statement may not apply to you.

This publication could include technical inaccuracies or typographical errors. Changes are periodically made to the information herein; these changes will be incorporated in new editions of the publication. IBM may make improvements and/or changes in the product(s) and/or the program(s) described in this publication at any time without notice.

Licensees of this program who wish to have information about it for the purpose of enabling: (i) the exchange of information between independently created programs and other programs (including this one) and (ii) the mutual use of the information which has been exchanged, should contact IBM United Kingdom Laboratories, MP151, Hursley Park, Winchester, Hampshire, England, SO21 2JN. Such information may be available, subject to appropriate terms and conditions, including in some cases, payment of a fee.

The licensed program described in this document and all licensed material available for it are provided by IBM under terms of the IBM Customer Agreement, IBM International Programming License Agreement, or any equivalent agreement between us.

---

## Trademarks

IBM, the IBM logo, and [ibm.com](http://ibm.com) are trademarks or registered trademarks of International Business Machines Corp., registered in many jurisdictions worldwide. A current list of IBM trademarks is available on the Web at Copyright and trademark information at [www.ibm.com/legal/copytrade.shtml](http://www.ibm.com/legal/copytrade.shtml).

Adobe and the Adobe logo are either registered trademarks or trademarks of Adobe Systems Incorporated in the United States, and/or other countries.

Java and all Java-based trademarks and logos are trademarks or registered trademarks of Oracle and/or its affiliates.

Other product and service names might be trademarks of IBM or other companies.



---

# Readers' Comments — We'd Like to Hear from You

**CICS Transaction Server for z/OS  
Customization Guide  
Version 3 Release 2**

**Publication No. SC34-6814-04**

We appreciate your comments about this publication. Please comment on specific errors or omissions, accuracy, organization, subject matter, or completeness of this book. The comments you send should pertain to only the information in this manual or product and the way in which the information is presented.

For technical questions and information about products and prices, please contact your IBM branch office, your IBM business partner, or your authorized remarketer.

When you send comments to IBM, you grant IBM a nonexclusive right to use or distribute your comments in any way it believes appropriate without incurring any obligation to you. IBM or any other organizations will only use the personal information that you supply to contact you about the issues that you state on this form.

Comments:

Thank you for your support.

Submit your comments using one of these channels:

- Send your comments to the address on the reverse side of this form.
- Send a fax to the following number: +44-1962-816151
- Send your comments via email to: [idrcf@hursley.ibm.com](mailto:idrcf@hursley.ibm.com)

If you would like a response from IBM, please fill in the following information:

\_\_\_\_\_

Name

\_\_\_\_\_

Address

\_\_\_\_\_

Company or Organization

\_\_\_\_\_

Phone No.

\_\_\_\_\_

Email address



Fold and Tape

**Please do not staple**

Fold and Tape

PLACE  
POSTAGE  
STAMP  
HERE

IBM United Kingdom Limited  
User Technologies Department (MP095)  
Hursley Park  
Winchester  
Hampshire  
SO21 2JN  
United Kingdom

Fold and Tape

**Please do not staple**

Fold and Tape





Product Number: 5655-M15

SC34-6814-04





Spine information:



CICS Transaction Server for z/OS Customization Guide

Version 3  
Release 2