

z/OS



Hardware Configuration Definition Planning

z/OS



Hardware Configuration Definition Planning

Note

Before using this information and the product it supports, be sure to read the general information under "Notices" on page D-1.

Seventh Edition, March 2004

This is a major revision of GA22-7525-05.

This edition applies to Version 1 Release 5 of z/OS (5694-A01), to Version 1 Release 5 of z/OS.e (5655-G52), and to all subsequent releases and modifications until otherwise indicated in new editions.

IBM welcomes your comments. A form for readers' comments may be provided at the back of this document, or you may address your comments to the following address:

International Business Machines Corporation
Department 55JA, Mail Station P384
2455 South Road
Poughkeepsie, NY 12601-5400
United States of America

FAX (United States & Canada): 1+845+432-9405

FAX (Other Countries):

Your International Access Code +1+845+432-9405

IBMLink™ (United States customers only): IBMUSM10(MHVRCFS)

Internet e-mail: mhvrcfs@us.ibm.com

World Wide Web: <http://www.ibm.com/servers/eserver/zseries/zos/webqs.html>

If you would like a reply, be sure to include your name, address, telephone number, or FAX number.

Make sure to include the following in your comment or note:

- Title and order number of this document
- Page number or topic related to your comment

When you send information to IBM, you grant IBM a nonexclusive right to use or distribute the information in any way it believes appropriate without incurring any obligation to you.

© Copyright International Business Machines Corporation 1989, 2004. All rights reserved.

US Government Users Restricted Rights – Use, duplication or disclosure restricted by GSA ADP Schedule Contract with IBM Corp.

Contents

Figures	v
About this document	vii
Who should use this document	vii
How to use this document	vii
Where to find more information	vii
Information updates on the web	viii
Accessing z/OS licensed documents on the Internet	ix
Using LookAt to look up message explanations	ix
Summary of changes	xi
Chapter 1. Introduction	1-1
I/O configuration definition process	1-1
Defining an I/O configuration to the software.	1-2
Defining an I/O Configuration to the Hardware	1-4
Ensuring that the software and hardware definitions match	1-6
Changing hardware and software I/O configuration definitions	1-8
Making both hardware and software dynamic changes	1-8
Making software-only dynamic changes	1-9
Using HCM for I/O definition	1-10
Chapter 2. Planning your I/O configuration definition	2-1
Components of a configuration.	2-1
Logical partitions	2-2
Logical control units for I/O devices	2-2
Channel path numbering	2-3
Selection of the path to access an I/O device	2-3
Making decisions about your configuration	2-3
Defining operating system data	2-4
Defining switch data.	2-4
Defining processor, logical channel subsystem, partition and channel path data	2-5
Defining control unit data	2-7
Defining I/O device data	2-7
z990 processor considerations	2-8
Deciding about JES3 initialization stream checker data	2-9
Understanding a sysplex configuration	2-10
Defining coupling facility components in a sysplex	2-10
Managing IOCDs and IPL attributes across a sysplex	2-14
Using automatic tape switching	2-16
Steps to setting up automatic tape switching	2-17
Defining shared channel paths	2-18
Considerations for sharing channel paths	2-19
Defining logical partition access to a channel path	2-19
Processors communicating through shared ESCON or FICON channel paths	2-21
Defining dynamically managed channel paths	2-22
Defining spanned channel paths.	2-24
Considerations for spanning channel paths.	2-24
FICON channels	2-25
Channel path definitions.	2-25
Dynamic activation.	2-25

Migration	2-25
Defining IQD CHPIDs and device types	2-28
Specifying an I/O device number	2-28
Replicating I/O device numbers	2-29
I/O device numbers for multiple exposure devices	2-29
I/O device numbers for a parallel access volume.	2-29
Workload manager and dynamic alias management	2-31
Specifying I/O device parameters and features	2-32
Defining whether an I/O device will be dynamic	2-32
Defining a tape device as automatically switchable	2-34
Defining the location of an I/O device's unit control block (UCB)	2-35
Defining allocation preferences	2-39
Understanding I/O device allocation in MVS	2-39
Defining device allocation in HCD	2-45
Chapter 3. Specifying an I/O configuration at IPL	3-1
Defining your initial I/O configuration.	3-1
IODF processing at IPL	3-5
Defining your I/O configuration for re-IPL	3-10
Chapter 4. Dynamically changing an I/O configuration	4-1
Actions to change your configuration dynamically	4-1
Dynamically changing an I/O configuration in LPAR mode.	4-2
Example of deleting an I/O device in LPAR mode	4-3
Dynamically changing an I/O configuration on a z990 processor	4-4
Dynamically changing an I/O configuration in a sysplex.	4-7
Dynamically changing component definitions.	4-8
Making dynamic changes to I/O devices	4-8
Making dynamic changes to channel paths.	4-12
Making dynamic changes to control units	4-14
Making changes to coupling facility devices and control units	4-16
Migrating to the dynamic capability provided with HCD	4-18
UCB services considerations	4-19
Specifying devices as dynamic after a migration	4-21
Testing dynamic activation	4-22
Recovery during dynamic configuration	4-23
Recovering dynamic configuration changes.	4-23
Recovering LPAR mode dynamic configuration changes	4-24
Appendix A. Device support for dynamic configuration	A-1
Appendix B. Summary of device information	B-1
Appendix C. Accessibility	C-1
Using assistive technologies	C-1
Keyboard navigation of the user interface.	C-1
z/OS Information	C-1
Notices	D-1
Trademarks.	D-2
Index	X-1

Figures

1-1.	I/O Configuration to the Software	1-2
1-2.	I/O Configuration to Hardware	1-5
2-1.	Configuration Example	2-1
2-2.	Logical Control Unit Examples	2-2
2-3.	Example of a Sysplex	2-10
2-4.	Support Elements connected to the Hardware Management Console.	2-15
2-5.	Shared Channel Paths	2-19
2-6.	Logical Addresses and Logical Partition Numbers	2-21
2-7.	Dynamic Channel Path Management	2-22
2-8.	Control Unit - PAV Device Relationship.	2-30
2-9.	Relationships among Generic and Esoteric Device Groups	2-40
2-10.	Example of Device Preference Table Affecting UNIT=AFF	2-44
2-11.	Example of Device Preference Table Affecting the Default Unit-Affinity-Ignored Unit Name	2-45
3-1.	Specifying IODF at IPL	3-6
4-1.	Sample Processor Running in LPAR Mode	4-4
4-2.	Dynamic I/O reconfiguration management on a z990 with compatibility support	4-5
4-3.	Dynamically adding CHPIDs in a two LCSS environment on a z990 with compatibility support	4-5
4-4.	Dynamically adding control units and devices in a two LCSS environment on a z990 with compatibility support	4-6
4-5.	Dynamically adding shared resources in a two LCSS environment on a z990 with compatibility support	4-7

About this document

This document supports z/OS™ (5694-A01) and z/OS.e (5655G52), and helps you understand how to define an I/O configuration using Hardware Configuration Definition (HCD). It describes how to:

- Plan a configuration definition
- Specify a configuration at IPL
- Define an I/O configuration dynamically

Who should use this document

This document is intended for anyone who plans an installation's I/O configuration and creates and coordinates action plans to change an I/O configuration. The document is written for someone who is experienced in or has had education in managing information systems.

How to use this document

If you are using this document for the first time, you should read all chapters. Subsequently, you can read the specific chapter for the task that you are performing.

This document contains:

- **Chapter 1, “Introduction”** presents an overview of I/O configuration using Hardware Configuration Definition (HCD) and dynamic configuration.
- **Chapter 2, “Planning your I/O configuration definition”** describes the decisions you need to make when planning to define your I/O configuration using HCD and dynamic configuration.
- **Chapter 3, “Specifying an I/O configuration at IPL”** describes the steps to define your I/O configuration at IPL.
- **Chapter 4, “Dynamically changing an I/O configuration”** describes the steps to define your I/O configuration dynamically and the following information for using dynamic:
 - **Migrating to the dynamic capability provided with HCD** explains the migration process for dynamic configuration.
 - **Testing dynamic activation** describes testing a changed configuration before activating it dynamically.
 - **Recovery during dynamic configuration** describes recovery procedures during a dynamic change.

Where to find more information

This document describes how to plan for defining your configuration using HCD. For information about using the specific HCD panels, see *z/OS HCD User's Guide* and the HCD help. Also you might want to see the *ITSO MVS/ESA™ HCD and Dynamic I/O Reconfiguration Primer, SG24-4037*, for an example of defining an entire, real-life configuration. This primer is available separately from z/OS.

For information about using Hardware Configuration Manager (HCM) for defining your configuration, see *z/OS and z/VM HCM User's Guide*.

Where necessary, this document references information in other documents, using shortened versions of the document title. For complete titles and order numbers of

the books for all products that are part of z/OS, see *z/OS Information Roadmap*. The following table lists titles and order numbers for documents available separately from z/OS.

Short title	Publication title	Order number
<i>Enterprise System/9000[®] Operator Guide</i>	<i>Enterprise System/9000 Models 190, 210, 260, 320, 440, and 480 Operating and Recovery Guide</i>	GA23-0375
<i>Enterprise System/9000 Operator Guide</i>	<i>Enterprise System/9000 330, 340, 500, 580, 620, and 720 Operator Guide</i>	SC38-0085
<i>Hardware Management Console Guide</i>	<i>Hardware Management Console Operations Guide</i>	GC38-0470
<i>IOCP User's Guide</i>	<i>IBM[®] ES/3090[™] Processor Complex Input/Output Configuration Program User's Guide and Reference</i>	SC38-0066
<i>IOCP User's Guide</i>	<i>IBM ES/9000[®] ES/3090 Input/Output Configuration Program User's Guide, Volume A04</i>	GC38-0097
<i>IOCP User's Guide</i>	<i>Input/Output Configuration Program User's Guide/ ESCON[®] Channel-to-Channel Reference</i>	GC38-0401
<i>IOCP User's Guide</i>	<i>IBM 4381 Processor Input/Output Configuration Program User's Guide and Reference</i>	GC24-3964
<i>IOCP User's Guide for IYP IOCP</i>	<i>Input/Output Configuration Program User's Guide for IYP IOCP</i>	SB10-7029
<i>Stand-Alone IOCP User's Guide</i>	<i>Stand-Alone IOCP, Generation 5, Generation 6</i>	GC38-0458
<i>Stand-Alone IOCP User's Guide</i>	<i>Stand-Alone Input/Output Configuration Program User's Guide</i>	SB10-7032
<i>ESCON CTC Reference</i>	<i>ESCON Channel-to-Channel Reference</i>	SB10-7034
<i>PR/SM Planning Guide</i>	<i>PR/SM Planning Guide</i>	GA22-7236
<i>Support Element Operations Guide</i>	<i>Support Element Operations Guide</i>	GC38-3119
<i>S/390 Parallel Enterprise Server[™] - Generation 5 System Overview</i>	<i>S/390 Parallel Enterprise Server - Generation 5 System Overview</i>	GA22-7158

Additional hardware documents are available for specific processors. Consult the documentation that comes with your processor for titles and order numbers of related documents.

Information updates on the web

For the latest information updates that have been provided in PTF cover letters and Documentation APARs for z/OS and z/OS.e, see the online document at:

<http://www.s390.ibm.com:80/bookmgr-cgi/bookmgr.cmd/BOOKS/ZIDOCMST/CCONTENTS>

This document is updated weekly and lists documentation changes before they are incorporated into z/OS publications.

Accessing z/OS licensed documents on the Internet

z/OS licensed documentation is available on the Internet in PDF format at the IBM Resource Link™ Web site at:

<http://www.ibm.com/servers/resourceLink>

Licensed documents are available only to customers with a z/OS license. Access to these documents requires an IBM Resource Link user ID and password, and a key code. With your z/OS order you received a Memo to Licensees, (GI10-0671), that includes this key code. ¹

To obtain your IBM Resource Link user ID and password, log on to:

<http://www.ibm.com/servers/resourceLink>

To register for access to the z/OS licensed documents:

1. Sign in to Resource Link using your Resource Link user ID and password.
2. Select **User Profiles** located on the left-hand navigation bar.

Note: You cannot access the z/OS licensed documents unless you have registered for access to them and received an e-mail confirmation informing you that your request has been processed.

Printed licensed documents are not available from IBM.

You can use the PDF format on either **z/OS Licensed Product Library CD-ROM** or IBM Resource Link to print licensed documents.

Using LookAt to look up message explanations

LookAt is an online facility that lets you look up explanations for most of the IBM messages you encounter, as well as for some system abends and codes. Using LookAt to find information is faster than a conventional search because in most cases LookAt goes directly to the message explanation.

You can use LookAt from the following locations to find IBM message explanations for z/OS elements and features, z/VM®, and VSE:

- The Internet. You can access IBM message explanations directly from the LookAt Web site at <http://www.ibm.com/eserver/zseries/zos/bkserv/lookat/>.
- Your z/OS TSO/E host system. You can install code on your z/OS or z/OS.e systems to access IBM message explanations, using LookAt from a TSO/E command line (for example, TSO/E prompt, ISPF, or z/OS UNIX® System Services running OMVS).
- Your Windows® workstation. You can install code to access IBM message explanations on the *z/OS Collection* (SK3T-4269), using LookAt from a Windows DOS command line.
- Your wireless handheld device. You can use the LookAt Mobile Edition with a handheld device that has wireless access and an Internet browser (for example, Internet Explorer for Pocket PCs, Blazer, or Eudora for Palm OS, or Opera for Linux handheld devices). Link to the LookAt Mobile Edition from the LookAt Web site.

1. z/OS.e™ customers received a Memo to Licensees, (GI10-0684) that includes this key code.

You can obtain code to install LookAt on your host system or Windows workstation from a disk on your *z/OS Collection* (SK3T-4269), or from the LookAt Web site (click **Download**, and select the platform, release, collection, and location that suit your needs). More information is available in the LOOKAT.ME files available during the download process.

Summary of changes

Summary of changes for GA22-7525-06 z/OS Version 1 Release 5

This document contains information previously presented in *z/OS HCD Planning*, GA22-7525-05, which supports z/OS Version 1 Release 4.

This document contains terminology, maintenance, and editorial changes. Technical changes or additions to the text and illustrations are indicated by a vertical line to the left of the change.

Starting with z/OS V1R2, you may notice changes in the style and structure of some content in this document — for example, headings that use uppercase for the first letter of initial words only, and procedures that have a different look and format. The changes are ongoing improvements to the consistency and retrievability of information in our documents.

Summary of changes for GA22-7525-05 z/OS Version 1 Release 4 as updated October, 2003

This document contains information previously presented in *z/OS HCD Planning*, GA22-7525-04, which supports z/OS Version 1 Release 4.

New information

- This document contains new information about the IBM @server zSeries 990 processor and z990 compatibility and exploitation support in Chapter 2, “Planning your I/O configuration definition,” on page 2-1 and Chapter 4, “Dynamically changing an I/O configuration,” on page 4-1.

This document contains terminology, maintenance, and editorial changes, including changes to improve consistency and retrievability.

Summary of changes for GA22-7525-04 z/OS Version 1 Release 4 as updated June, 2003

This document contains information previously presented in *z/OS HCD Planning*, GA22-7525-03, which supports z/OS Version 1 Release 4.

New information

- This document contains new information about the IBM @server zSeries 990 processor and z990 compatibility and exploitation support in Chapter 2, “Planning your I/O configuration definition,” on page 2-1 and Chapter 4, “Dynamically changing an I/O configuration,” on page 4-1.

This document contains terminology, maintenance, and editorial changes, including changes to improve consistency and retrievability.

**Summary of changes
for GA22-7525-03
z/OS Version 1 Release 4**

This document contains information previously presented in *z/OS HCD Planning*, GA22-7525-02, which supports z/OS Version 1 Release 3.

New information

- Information is added to indicate this document supports z/OS.e.

This document contains terminology, maintenance, and editorial changes, including changes to improve consistency and retrievability.

**Summary of changes
for GA22-7525-02
z/OS Version 1 Release 3**

This document contains information previously presented in *z/OS HCD Planning*, GA22-7525-01, which supports z/OS Version 1 Release 2.

New information

- Chapter 2, “Planning your I/O configuration definition,” on page 2-1 contains new information about:
 - The new “ATS STAR” design, which improves the availability and system management characteristics of the existing automatic tape switching function.

This document contains terminology, maintenance, and editorial changes, including changes to improve consistency and retrievability.

**Summary of changes
for GA22-7525-01
z/OS Version 1 Release 2**

This document contains information previously presented in *z/OS HCD Planning*, GA22-7525-00, which supports z/OS Version 1 Release 1.

New information

- Chapter 2, “Planning your I/O configuration definition,” on page 2-1 contains new information about:
 - FICON™ CTC connections between IBM @server zSeries 900 processors
 - IQD CHPIDs and device types

This document contains terminology, maintenance, and editorial changes, including changes to improve consistency and retrievability.

**Summary of changes
for GA22-7525-00
z/OS Version 1 Release 1**

This document contains information also presented in *OS/390® HCD Planning*.

Technical changes include:

- “Defining dynamically managed channel paths” on page 2-22 gives an overview of dynamic channel path management, a subfunction of the Intelligent Resource Director.

Chapter 1. Introduction

An I/O configuration is the hardware resources available to the operating system and the connections between these resources. The resources include:

- Channels
- ESCON/FICON Directors (switches)
- Control units
- Devices

When you define a configuration, you need to provide both physical and logical information about these resources. For example, when defining a device you provide physical information, such as its type and model, as well as logical information such as the identifier you will assign in the configuration definition. Chapter 2, “Planning your I/O configuration definition,” on page 2-1 describes the information you need to provide for each resource.

You must define an I/O configuration to the operating system (software) and the channel subsystem (hardware). The Hardware Configuration Definition (HCD) element of z/OS consolidates the hardware and software I/O configuration processes under a single interactive end-user interface. The validation checking that HCD does as you enter data helps to eliminate errors before you attempt to use the I/O configuration.

The output of HCD is an I/O definition file (IODF), which contains I/O configuration data. An IODF is used to define multiple hardware and software configurations to the z/OS operating system. When you activate an IODF, HCD defines the I/O configuration to the channel subsystem and/or the operating system. With the HCD activate function or the MVS™ ACTIVATE operator command, you can make changes to the current configuration without having to initial program load (IPL) the software or power-on reset (POR) the hardware. Making changes while the system is running is known as dynamic configuration or dynamic reconfiguration.

You select your I/O configuration when you:

- POR
- IPL
- Activate a dynamic configuration change

IPL and activation require that you identify the IODF that contains the definition of your configuration. A data set called an I/O configuration data set (IOCDS) is used at POR. An IOCDS can be created from a configuration definition in an IODF. The IOCDS contains the configuration for a specific processor, while the IODF contains configuration data for multiple processors.

This chapter:

- Introduces defining and selecting an I/O configuration through Hardware Configuration Definition (HCD).
- Introduces changing the I/O configuration using dynamic configuration, a method for selecting configurations.

I/O configuration definition process

You specify a configuration to the software at IPL or at dynamic configuration. You specify a configuration to the hardware at POR or at dynamic configuration.

When you dynamically change a configuration, you can change the I/O configuration definitions to both hardware and software or to software only. ¹ A software-only change modifies only the software control structures, such as the unit control blocks (UCBs) and the eligible device table (EDT). A hardware and software change modifies both the hardware and software control structures. In most cases, you will make simultaneous dynamic configuration changes to both hardware and software configuration definitions.

Defining an I/O configuration to the software

Figure 1-1 introduces the process of defining an I/O configuration to the software. At IPL, the system reads an IODF and constructs UCBs, an EDT, and all device and I/O configuration-related control blocks. When you select and activate a new configuration, the system determines the changes needed to the UCBs and EDT based on comparing the current IODF and the newly selected IODF. More detailed descriptions follow the figure.

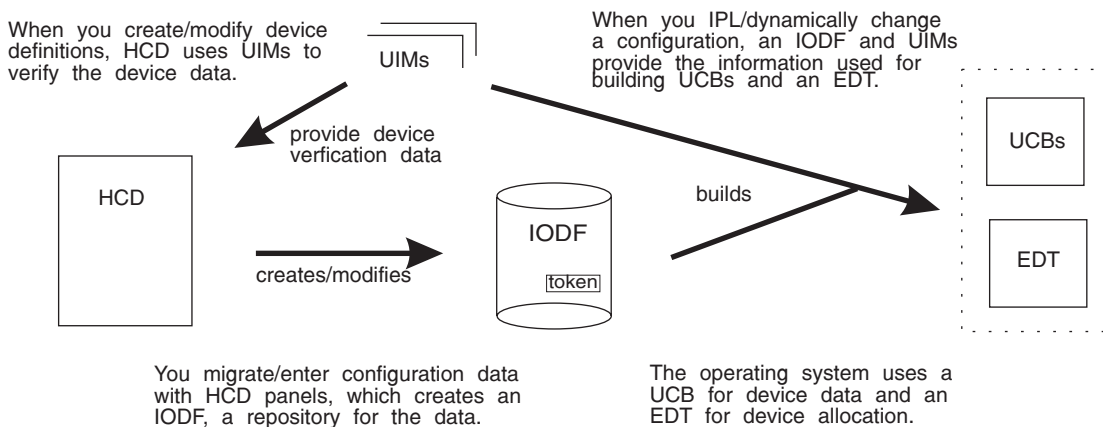

Figure 1-1. I/O Configuration to the Software

HCD

Hardware Configuration Definition (HCD) is an interactive interface that enables an installation to define I/O configurations to both the software and hardware from one interface. To define configurations to the hardware and software, you use HCD to create an input/output definition file (IODF).

You can use HCD to perform the following major tasks:

- Define new configuration data (an IODF or parts of an IODF)
 - Activate configuration data
 - View and modify existing configuration data
 - Maintain IODFs (such as, copy, import, and export)
 - Query and print configuration data
 - Migrate configuration data
 - Compare the active I/O configuration to a defined I/O configuration in an IODF.
- For a description of the software required for this verification, see *z/OS and z/OS.e Planning for Installation*.

IODF

An IODF contains information about the I/O configuration, such as:

- Operating system data

1. You can also make hardware only configuration changes. A logical partition can make dynamic configuration changes that affect the hardware configuration for other partitions. See "Dynamically changing an I/O configuration in LPAR mode" on page 4-2

- Switch data
- Device data, including EDT definition
- Processor data
- Partition data
- Channel path data
- Control unit data
- channel subsystem data

There are three types of IODF: a work IODF, a validated work IODF, and a production IODF.

Work IODF

A work IODF allows you to create a new I/O configuration definition or modify an existing I/O configuration definition. A work IODF provides a way to build or modify an IODF before you use it to activate a configuration. It is a working copy, not suitable for IPL selection or activated during dynamic activation. When a work IODF is ready to use, build a production IODF from it.

Validated work IODF

A validated work IODF satisfies all validation rules for building production IODFs. It may lack at least one physical channel identifier (PCHID). In cooperation with HCD and the CHPID Mapping Tool a validated IODF is required to accept new or updated PCHIDs. From such a validated work IODF, an IOCP input deck suitable for use with the CHPID Mapping Tool is generated. As soon as all PCHIDs are inserted or updated in the validated work IODF, the production IODF can be built. In HCD, you can use various methods to obtain a validated work IODF.

Production IODF

A production IODF defines one or more valid I/O configurations. A configuration in a production IODF can be activated dynamically or selected during IPL. Although you can build multiple production IODFs, only the one that is selected during IPL or activated during dynamic configuration is the active production IODF.

To change a configuration, create a work IODF from a production IODF. When you attempt to change a production IODF, HCD automatically copies the production IODF into a work IODF so you can make your changes. When changes are complete, build a production IODF from the work IODF.

You can organize your configuration data in an IODF in multiple ways. For example:

- You can define multiple operating system and processor configurations in one IODF. The configurations can share common device definitions; this reduces the maintenance effort when devices are changed.
- For a processor that supports logical partitions, you can define the configurations for the processor and the operating systems running in the logical partitions of that processor in one IODF.

Note: z/OS.e must run in an LPAR named ZOSExxxx, where xxxx represents any permitted alphanumeric characters you choose. If you are running z/OS, you cannot use ZOSExxxx as an LPAR name.

- From the IODF representing the complete configuration (master IODF), you can create IODFs containing parts of the whole configuration (for example, a processor with all of its relevant operating systems). These IODFs can be distributed to a target system and used for activation. Note that the processor

token does not change during the distribution process. You can also merge distributed IODFs in the master IODF. For information about handling large IODFs, see *z/OS HCD User's Guide*.

- You can define several IODFs for the same hardware, with different configurations for use in different circumstances. However, this approach is not recommended, because you might need to update multiple IODFs when you change the configuration.

z/OS MVS System Data Set Definition describes IODF allocation and placement considerations.

UIMs

Unit information modules (UIMs) contain the information and rules that HCD uses to process I/O device definitions. When you create an IODF, HCD uses UIMs to validate the device definitions you enter. The system invokes UIMs at IPL or during a dynamic configuration change to build UCBs.

UIMs are provided with IBM product software for devices that z/OS supports. For a non-supported device, you may be able to use a generic UIM or a UIM from a similar IBM device. Also if you have an MVSCP UIM for a device, you can convert it to an HCD UIM. For information about converting an MVSCP UIM to an HCD UIM, see *z/OS MVS Device Validation Support*.

Through the query function in HCD, you can view a list of the UIMs that your installation currently has installed.

UCB

A unit control block (UCB) holds information about an I/O device, such as:

- State information for the device
- Features of the device

You can access information in UCBs using UCB services, such as UCBSCAN and UCBLOOK. At IPL or dynamic configuration, UCBs are built from HCD device definition information in the IODF and UIMs. There is a UCB for each I/O device in a configuration.

EDT

An eligible device table (EDT) is an installation-defined and named representation of the I/O devices that are eligible for allocation. Using HCD, you define EDT information in an IODF. At IPL or dynamic configuration, information in the IODF and UIMs is used to build the EDT.

Defining an I/O Configuration to the Hardware

Figure 1-2 on page 1-5 introduces the process of defining an I/O configuration to the hardware. A configuration is defined to hardware when an IOCDS initializes the IOCDS information in the hardware system area (HSA) during a POR. A configuration is also defined to hardware when information in HSA is updated during a dynamic configuration change. More detailed descriptions follow the figure.

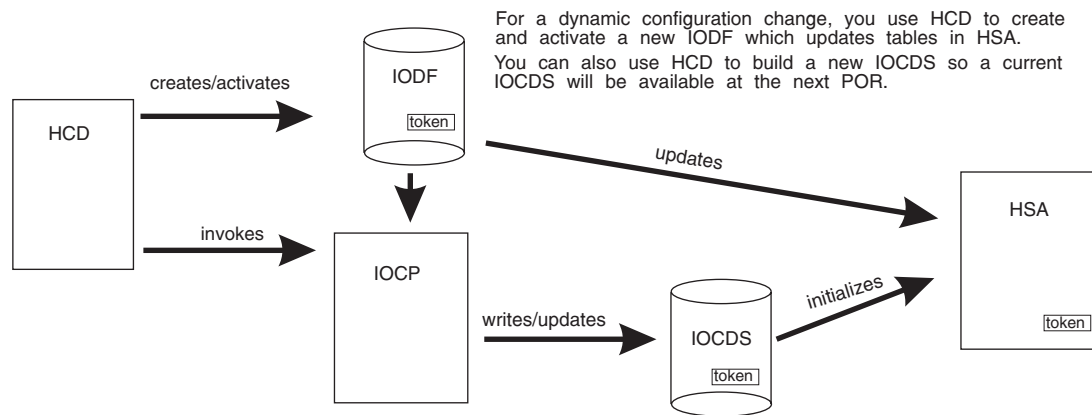

At POR, the system uses information in the IOCDs to create tables in HSA.

Figure 1-2. I/O Configuration to Hardware

IOCP

I/O configuration program (IOCP) creates an IOCDs to define a configuration to the channel subsystem at POR. IOCP is shipped on the z/OS tape, and a stand-alone version is available on a processor.

You can specify at any time that you want an IOCDs written for a configuration defined in an IODF. It is a good practice to write an IOCDs when you activate an IODF so a current IOCDs is available for the next POR. Use the HCD Activate and Process Configuration Data panel and its option “Build IOCDs”. HCD invokes IOCP to write an IOCDs. IOCP builds a configuration definition from IODF information and stores the definition in an IOCDs so it is available when a POR is required.

Processors can have multiple I/O configuration data sets. On an HCD panel, you can specify the one that you want to update.

Notes:

1. For the following processors, you can use the option “Build and manage S/390[®] microprocessor IOCDs and IPL attributes” to update the selected IOCDs of one or more selected processors:

|
|
|
|
|
|
|
|
|
|
|
|

- S/390 9672 Parallel Enterprise Server R2 and R3 models, as well as Generation 3 (these processors will run OS/390 Version 2 Release 10, but not z/OS V1R1 or higher)
- S/390 9672 Parallel Enterprise Server G5 and G6
- S/390 Application StarterPak (3000 models)
- S/390 Multiprise[®] 2000 (2003 models)(this processor will run OS/390 Version 2 Release 10, but not z/OS V1R1 or higher)
- S/390 Multiprise 3000 (7060 models)
- IBM @server zSeries 800
- IBM @server zSeries 900
- IBM @server zSeries 990

See “Understanding a sysplex configuration” on page 2-10 for more information.

2. When you install a new processor that does not contain an IOCDS, you can use HCD to build an IOCP input deck, transfer the data set to tape, and run the processor's IOCP stand-alone program.

IOCDS (Input/Output Configuration Data Set)

An IOCDS contains information to define the I/O configuration to the processor complex's channel subsystem. The IOCDS is built by the IOCP. A POR loads the IOCDS into HSA to initialize the hardware to reflect the IOCDS. IOCDSs for a processor are stored on the:

- Support element hard disk for:
 - S/390 9672 Parallel Enterprise Server R2 and R3 models, as well as Generation 3 (these processors will run OS/390 Version 2 Release 10, but not z/OS V1R1 or higher)
 - S/390 9672 Parallel Enterprise Server G5 and G6
 - S/390 Application StarterPak (3000 models)
 - S/390 Multiprise 2000 (2003 models)(this processor will run OS/390 Version 2 Release 10, but not z/OS V1R1 or higher)
 - S/390 Multiprise 3000 (7060 models)
 - IBM @server zSeries 800
 - IBM @server zSeries 900
 - IBM @server zSeries 990
- Processor controller DASD for other processors

HSA

The hardware system area (HSA) contains tables that include information about the current configuration.

Ensuring that the software and hardware definitions match

Before your first dynamic configuration change, you must use HCD to create an IOCDS from the IODF that will be used for a subsequent IPL, then perform a POR using that IOCDS. The POR places information about the hardware configuration in the hardware system area (HSA). The same IODF must be used at IPL to define the software configuration.

To be able to perform a software and hardware dynamic change, your hardware and software definitions must match. When you use the same IODF to define your software and hardware configurations, the software and hardware definitions match.

However, there may be times when you want to change your software definition, for example, to temporarily run a test system. To change your software definition, you might perform a software-only dynamic change using a different IODF. In this case, your software and hardware definitions do not match and you cannot perform a full hardware and software dynamic configuration change.

To be able to make a dynamic hardware and software change, you can perform a software-only change using the IODF that was used to define the current hardware configuration. This IODF is the one used to define the software and hardware configuration at POR or at the last full software and hardware dynamic configuration change.

Note: You could also perform a POR and the subsequent IPLs using the IODF with the current software configuration so the software and hardware definitions match.

Of course, the software-only dynamic change does not require an IPL. You just need to remember the IODF that you last used to define the software and hardware configuration so you can use it for the software-only change. This IODF is the one you used for the last POR or the last full software and hardware dynamic change. When you use this IODF for the software-only change, the software and hardware definitions match.

On the HCD View Active Configuration panel, you can view the IODF used for the last POR or software and hardware dynamic configuration change. To display the panel, choose the “Activate or process configuration data” option from the HCD primary menu and then the “View active configuration” option.

You can also use a token called the processor configuration token ² to find the IODF. The processor configuration token exists in three places as described in Table 1-1.

Table 1-1. Location of Processor Configuration Token

Where the Processor Configuration Token Exists	When the Token Is Placed There	How You Can View the Token There
In a production IODF There is a processor configuration token for each processor definition.	When you change a processor definition and build a new production IODF, a unique token is placed in the production IODF.	View the token in the Processor Token field on the HCD View Processor Definition panel
In an IOCDS	When you build an IOCDS, the unique token is placed in the IOCDS.	View the token from the Hardware Management Console or use HCD on these processors: <ul style="list-style-type: none"> • S/390 9672 Parallel Enterprise Server • S/390 Application StarterPak (3000 models) • S/390 Multiprise 2000 (2003 models)(this processor will run OS/390 Version 2 Release 10, but not z/OS V1R1 or higher) • S/390 Multiprise 3000 (7060 models) • IBM @server zSeries 800 • IBM @server zSeries 900 • IBM @server zSeries 990
In HSA	When you POR your processor or activate a dynamic change to the software and hardware, the IOCDS information is used to create tables in HSA. HSA then contains the unique token.	View the token when you enter the MVS command 'D IOS, CONFIG' or view the token on the HCD View Active Configuration panel.

2. Do not confuse the processor configuration token with the MVS I/O configuration token. The MVS I/O configuration token enables programs (that require configuration data) to detect that dynamic changes have occurred. You obtain the token with the IOCINFO, UCBSCAN, and EDTINFO macros. For more information, see *z/OS MVS Programming: Assembler Services Guide*.

To determine the IODF that you last used for the software and hardware definition, view the token in HSA. Then view the tokens for each processor definition in the production IODFs until you find the IODF with the token that matches the token in HSA.

After you determine the IODF from the last POR or software and hardware dynamic configuration, use that IODF for a software-only change to have the software and hardware configurations match.

Attention: If the only IODF matching the hardware configuration in HSA is accidentally deleted, no dynamic changes are possible until after the next POR. For this reason, always keep a backup copy of your current IODF.

Changing hardware and software I/O configuration definitions

Changes to an I/O configuration include adding, deleting, and modifying the definitions of I/O components:

- You add an I/O component to the configuration definition by including the component's description in an IODF. You use HCD panels to add the component to a work IODF and create a production IODF from the work IODF.
- You delete an I/O component from the configuration definition by removing the component's description from an IODF. You use HCD panels to delete the component from a work IODF and create a production IODF from the work IODF.
- You change an I/O component in the configuration by changing the value of a characteristic in the component description in the IODF. You use the HCD panels to change component characteristics in a work IODF and create a production IODF from the work IODF.

Notes:

1. Some changes to device characteristics cause the UCB to be deleted and added again when the dynamic configuration change occurs. Message IOS502I reports the deleted and added device.
2. Any dynamic change that causes a device's UCB to be deleted and added again, causes the device's MIH time interval to be reset to the default MIH setting for its device class. To reestablish the previous MIH interval, issue the MVS command SETIOS MIH when the dynamic change is completed. For information about this command, see *z/OS MVS System Commands*.

In most cases, you will make simultaneous dynamic configuration changes to both hardware and software configuration definitions. However, in some cases making a change to only the software definition is useful. See "Making both hardware and software dynamic changes" and "Making software-only dynamic changes" on page 1-9.

Making both hardware and software dynamic changes

To make hardware and software changes, follow these steps:

1. Plan for changing the device configuration. For example, for adding devices, check that the device code was loaded at the last IPL. For deleting devices, verify that the device is not needed by any application running in the processor and that the device is offline. See "Making dynamic changes to I/O devices" on page 4-8 for more information.
2. Describe the new I/O configuration definition in an I/O definition file (IODF) that you create through HCD. See *z/OS HCD User's Guide*.

3. Activate the new IODF using the HCD Activate New Configuration panel or the ACTIVATE command.

On the HCD Activate New Configuration panel, choose the “Activate hardware and software configuration” option.

If you are using the ACTIVATE command, do **not** specify the SOFT keyword for hardware and software changes.

4. Use the HCD Build IOCDS task to write a new I/O configuration data set (IOCDS), if one does not already exist. You can make the new IOCDS the default for the next POR by issuing the ACTIVATE command with the ACTIOCDS=xx keyword. If necessary update the LOADxx members for each MVS system to point to the new IODF.
5. Install the new I/O components that you have dynamically added through the new IODF. As required, perform the following tasks:
 - Configure the channel paths
 - Initialize devices, for example, format DASD with the volume serial
 - Issue the MVS VARY DEVICE command to make the device available to the system, for example, 'VARY dddd,ONLINE'.

See Chapter 4, “Dynamically changing an I/O configuration,” on page 4-1 for more details about making dynamic changes.

Making software-only dynamic changes

Although, you will usually make hardware and software dynamic changes, there are times when a software-only change is useful:

- When the software I/O configuration does not match the hardware I/O configuration. For example, when the IODF that you used for IPL does not contain the hardware I/O configuration used to create the IOCDS.

You can use the software-only change to synchronize the software definition to the hardware definition so that a subsequent hardware and software change can be activated. When a software-only change switches the IODF, the new IODF can contain a processor configuration token that matches the current processor configuration token in HSA.

- When multiple logical partitions are running in LPAR mode. You make software-only changes in all partitions except one; in the remaining partition, you make a software and hardware change. (See “Dynamically changing an I/O configuration in LPAR mode” on page 4-2.)

- When MVS is a guest operating system running under VM.

You cannot use dynamic configuration to make hardware changes in an MVS guest system running under VM. However, you can use dynamic configuration to make software-only changes in the MVS guest system. Thus, you can add new devices to an MVS guest system using a VM interface (such as ATTACH or DEFINE), then use dynamic configuration to make software-only changes in the MVS guest system.

- When MVS is running on a processor that does not support dynamic configuration changes to hardware I/O configuration definitions. You can still make a software-only change, for example, to update the EDT or change the definition of a device from not shared to shared.

To make software-only changes, follow these steps:

1. Plan for your changes to the device definitions in the configuration. For example, for adding devices, check that the device code was loaded at the last

IPL. For deleting devices, verify that the device is not needed by any application running in the processor. See “Making dynamic changes to I/O devices” on page 4-8 for more information.

2. Describe the new I/O configuration definition in an I/O definition file (IODF) that you create through HCD. See *z/OS HCD User's Guide*.
3. Activate the new IODF using the HCD Activate New Configuration panel or the ACTIVATE command:
 - On the HCD Activate New Configuration panel, choose either of the following options:
 - Activate software configuration only and validate hardware changes
 - Activate software configuration only

Choose the “Activate software configuration only and validate hardware changes” option to validate that I/O components being deleted are not in use.

- On the ACTIVATE command, specify the SOFT keyword for software-only changes.

See Chapter 4, “Dynamically changing an I/O configuration,” on page 4-1 for more details about making dynamic changes.

Using HCM for I/O definition

The Hardware Configuration Manager (HCM), an optional feature of z/OS, works with HCD to provide a rich set of graphical and text configuration reports. HCM complements HCD by adding information about the physical properties of the processors and I/O configurations to the logical information that HCD provides. For example, the physical information about processors and I/O configurations includes details about the ESCON and FICON infrastructure such as cables, distribution panels, and patch panels.

HCM works as a client server application with HCD and uses the HCD validation process. Working with HCD, HCM combines logical and physical definitions into a single process. The HCM graphical interface allows users to define the configurations and to locate and display configuration objects and their connections. It also allows users to display operational data, such as system status information, and to operate on switches using an interface to the I/O operations component of System Automation for OS/390 (formerly known as ESCON Manager). The HCM graphical interface is helpful when planning configuration changes and doing problem determination. For additional information about HCM, see *z/OS and z/VM HCM User's Guide*.

Chapter 2. Planning your I/O configuration definition

You must gather the necessary information to create an IODF. This chapter describes:

- The components that you define in your I/O configuration in “Components of a configuration”
- The information you provide for the component definitions in “Making decisions about your configuration” on page 2-3
- More information needed for making decisions when defining your configuration in:
 - “Understanding a sysplex configuration” on page 2-10
 - “Defining shared channel paths” on page 2-18
 - “Specifying an I/O device number” on page 2-28
 - “Specifying I/O device parameters and features” on page 2-32
 - “Defining allocation preferences” on page 2-39

Components of a configuration

The components of an I/O configuration are shown in a sample configuration in Figure 2-1:

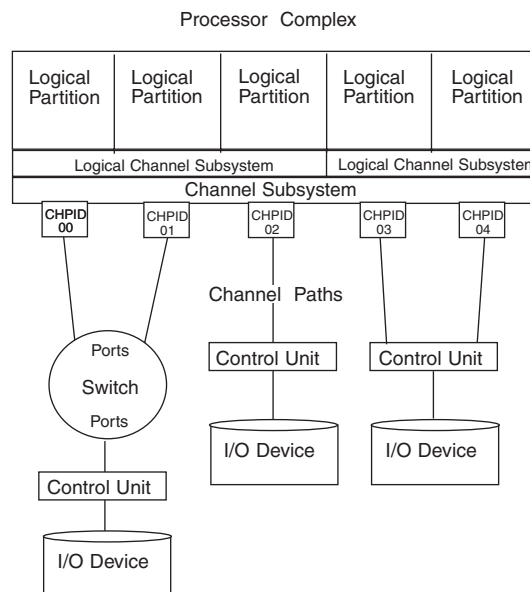

Figure 2-1. Configuration Example

Note: You can only use multiple logical channel subsystems, as shown in Figure 2-1, on z990 processors.

When you define the configuration, you specify:

- Operating systems
- Eligible device tables (EDTs) with esoteric device groups
- Processors
- Logical channel subsystems (for z990 processors)
- Partitions (if processor is in LPAR mode)
- Channel paths on the processor(s)

- Switches (ESCON directors or Fibre Channel switches) attached to the channel path (if any)
- Control units attached to channel paths or switches
- I/O devices connected to the control units

Logical partitions

The Processor Resource/System Manager (PR/SM™) feature allows a single processor to run multiple operating systems in logically partitioned (LPAR) mode.

Each operating system has its own logical partition, which is a separate set of system resources including:

- A portion of storage (central, or central and expanded)
- One or more central processors. The processors can be dedicated or shared.

LPAR mode is established when the processor has had the PR/SM feature installed and has been divided into logical partitions.

Notes:

1. z/OS.e must run in an LPAR named ZOSExxxx, where xxxx represents any permitted alphanumeric characters you choose. If you are running z/OS, you cannot use ZOSExxxx as an LPAR name.
2. The z990 only supports LPAR mode; you cannot run in basic mode.

Logical control units for I/O devices

There are restrictions on a dynamic activation that adds or deletes a control unit based on how the hardware definition groups physical control units into logical control units. Each of the following is considered a logical control unit:

- A physical control unit with no devices attached
- A physical control unit that does not share any devices
- A set of physical control units that share any devices in common

The type of processor determines the limit on the number of physical control units in a logical control unit. Figure 2-2 shows examples of logical control units.

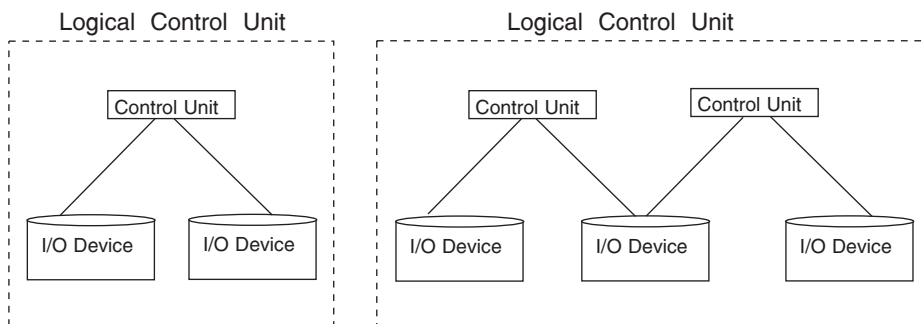

Figure 2-2. Logical Control Unit Examples

You cannot dynamically activate a change that causes one of the following:

- A physical control unit to be added to a logical control unit if the addition causes two logical control units (with devices attached) to merge into one logical control unit

- A physical control unit to be removed from a logical control unit if the deletion causes a split of one logical control unit (with devices attached) into two logical control units.

See *IOCP User's Guide* for requirements of defining control units to enable valid logical control units.

Channel path numbering

A channel path is logically identified by a two-digit hexadecimal number called a channel path identifier (CHPID). Some model processor complexes can have gaps in their channel path identifier (CHPID) numbering scheme due to the mix and number of installed parallel and ESCON channels. See the *IOCP User's Guide* for a description of the restrictions this might cause.

Selection of the path to access an I/O device

You can specify a preferred channel path to an I/O device. When you do not specify a preferred path, the channel subsystem uses a rotation order for the initiation of I/O requests to a device.

The rotation order is based on the:

- Control unit number you specify for a control unit that attaches a device
- Order channel paths are specified on a control unit

The channel subsystem tries the first channel path you specify for each control unit that attaches to the device, beginning with the lowest numbered control unit. The channel subsystem then tries the second channel path, if specified, for each control unit that attaches to the device, beginning with the lowest numbered control unit. The channel subsystem repeats this process until all specified channel paths for all control units attached to the device have been tried. See *IOCP User's Guide* for more information.

Using HCD, you can supply the information to establish preferred channel paths and the rotation order. To specify a preferred channel path, when you define a device, you specify the CHPID for the channel path in the Preferred CHPID field on the HCD "Device / Processor Definition" panel. When you assign control unit numbers and specify channel paths for control units, you can consider the rotation order to control the selection path order for devices.

Making decisions about your configuration

Before you actually define your configuration, decide on and collect the general information about the configuration components in a configuration plan. HCD provides reports about the processor support and UIMs installed on your system. These reports include information about device types, their parameters and features, and current connectivity rules. The Supported Hardware Report and the I/O Definition Reference are available as batch reports. After you define your configuration, you can use the reports that HCD generates to track updates to your plan.

After you create your configuration plan, use the HCD panels to specify the information about configuration components. HCD provides interactive help to describe the information for each field. The panels also enable you to request a list of options for some fields. For example, for the Processor Type and Model field, you can display a list of the available processor types to choose from with the Prompt function in the HCD panel.

The plan outline that follows shows the order that you would most likely follow to define your configuration:

1. Define Operating System Data
2. Define Switch Data
3. Define Processor, Logical Channel Subsystem, Partition, and Channel Path Data
4. Define Control Unit Data
5. Define I/O Device Data
6. Decide about JES3 Initialization Stream Checker Data (if you are running JES3)

Defining operating system data

To define the operating system configuration you need to decide on:

- An 8-byte EBCDIC identifier for the configuration
- For eligible device tables (EDTs) for I/O devices:
 - Decide how many EDTs to define
 - Specify a 2-digit identifier for each EDT, for example, 20
 - Decide how many esoteric device groups to define in each EDT
 - Specify a name for each group

See “Defining allocation preferences” on page 2-39 for a description of EDTs and esoteric groups. When you define a specific device to your configuration, you specify the esoteric group in which to include the device as described in “Defining I/O device data” on page 2-7.

Defining switch data

Using HCD, you can define both ESCON switches (ESCON directors, such as 9032–5) and Fibre Channel (FC) switches. You can define an FC switch as a FICON FC switch (type 2032) or as a generic FC switch (type FCS). The FICON FC switch supports an internal switch control unit and device whereas the generic FC switch does not.

To define switches in your configuration, you need to know the switch type (for example, 9032–3 or 9032–5). You need to decide on:

- Switch ID, such as 01
- Switch control unit number and switch device number: You must define a switch control unit and device to be able to use HCD and the I/O operations component of System Automation for OS/390 (formerly known as ESCON Manager) to update the switch configuration and to validate the switch data. When you specify a control unit number and device number in the HCD Add Switch panel, a control unit and device are defined to be the same type as the switch. Note that the FCS switch does not support a switch control unit and device.
- Description: text that you use to describe the switch

You also use HCD to define the connections of the switch ports to channels or control units. You can use HCD to define a matrix of all possible connections between any two ports as well. The matrix information can be migrated into HCD from an ISPF table containing a switch configuration from System Automation for OS/390, from an active ESCON Director (ESCD), a FICON Director, or from a saved ESCD file. Use the “Migrate Switch Configuration Data” option on the HCD Migrate Configuration Data panel.

Similarly, you can use HCD to generate a matrix containing the defined logical connections between channel paths and control units.

Note: Defining switch data is optional unless a system running the I/O operations component of System Automation for OS/390 wants to reconfigure the switch.

Defining processor, logical channel subsystem, partition and channel path data

To define processors in your configuration, you need to know:

- Processor type and model
- For a central processor complex (CPC) controlled through the Hardware Management Console, you need the system network architecture (SNA) address of its support element. You define each CPC in the following processors with its unique SNA address:
 - S/390 9672 Parallel Enterprise Server R2 and R3 models, as well as Generation 3 (these processors will run OS/390 Version 2 Release 10, but not z/OS V1R1 or higher)
 - S/390 9672 Parallel Enterprise Server G5 and G6
 - S/390 Application StarterPak (3000 models)
 - S/390 Multiprise 2000 (2003 models)
 - S/390 Multiprise 3000 (7060 models)
 - IBM @server zSeries 800
 - IBM @server zSeries 900
 - IBM @server zSeries 990

See “Understanding a sysplex configuration” on page 2-10 for more information.

- Serial number: If you specify a serial number, the system uses the number to verify that it is updating the correct processor during IOCDs download. This verification does not occur for a CPC that has a SNA address defined in HCD.
- Support level of the processor, for example if it supports ESCON channels. If only one support level is available for the processor type/model, you do not have to specify the support level in HCD.

To define processors in your configuration, you need to decide on:

- An 8-byte alphanumeric processor identifier: a name that you assign to identify the processor in HCD, such as, RN01PROC
- Processor mode: BASIC or LPAR
 - If a processor is in LPAR mode, you must define partitions in your configuration.
- If the processor supports multiple logical channel subsystems, then you must specify the number of channel subsystems, which must be at least one.
- Description: text that you use to describe the processor

To define multiple logical channel subsystems in your configuration, you need to decide:

- Which partitions are assigned to each logical channel subsystem.
- Which channel paths are defined to each logical channel subsystem.
- How many devices are allowed . The value you choose should include the number of devices you define in your current I/O configuration plus room for growth in your configuration.

To define partitions, you need to decide on:

- Partition name, such as MVS01 and RTR01
- Partition number/MIF image ID.

On a pre-z990 processor, the partition number you specify on the "Add partition" panel in HCD when you define your partitions is also used as the Multiple Image Facility (MIF) image ID. MIF enables logical partitions to share channel paths and coupling facility sender channel paths between logical partitions within a processor complex.

On a z990 processor, the partition number and the MIF image ID are not the same. On a z990, when you define your partitions via the "Add partition" panel in HCD, the value you specify is the MIF image ID, not the partition number. The system uses information in IOCDS to assign a partition number when you POR the machine. Because the value you specify on the HCD panel is a MIF image ID, the value must be between X'1' and X'F' and be unique within the logical channel subsystem. See "Processors communicating through shared ESCON or FICON channel paths" on page 2-21 for more information.

- Whether a partition will run an operating system, a coupling facility, or either, depending on whether coupling facility support is loaded. See "Understanding a sysplex configuration" on page 2-10 for more information.
- Description: text that you use to describe the partition

To define channel paths in your configuration, you first make your physical layout decisions such as your CHPID numbers for channels, number of channel paths, channel path type, and switch information if channel path(s) are connected to a switch. The switch information includes entry switch ID, ports, and dynamic switch ID. Then you need to decide on:

- Operation Mode: If a processor is in LPAR mode, you can specify the operation mode, which indicates the access that logical partitions will have to a channel path. The operation modes that you can specify for channel paths in HCD are:
 - **Dedicated** allows only one logical partition to access a channel path.
 - **Reconfigurable** allows only one logical partition at a time to access a channel path, but you can reconfigure that channel path from one logical partition to another. You reconfigure a channel path using the MVS CONFIG CHP(xx) command.
 - **Shared** allows more than one logical partition to access a channel path simultaneously. For information about shared channel paths, see "Defining shared channel paths" on page 2-18.

You can only specify shared mode when the support level of the processor has Multiple Image Facility (MIF) capability. See "Defining shared channel paths" on page 2-18 for a description of the advantages and considerations for using shared channel paths.

- **Spanned** allows partitions in more than one logical channel subsystem to share the same channel.
 - Note that not all types of channel paths can be defined as spanned. See "Defining spanned channel paths" on page 2-24.
- Access and Candidate Lists: These lists specify which logical partitions can access a channel path. See "Defining logical partition access to a channel path" on page 2-19 for information.
- Dynamic channel path management: If you are using dynamic channel path management, a subfunction of the Intelligent Resource Director, you need to define which channels and control units will participate. See "Defining dynamically managed channel paths" on page 2-22 for information.
- Intra-CPC communication: If you are using HiperSocket Accelerator, see "Defining IQD CHPIDs and device types" on page 2-28 for information.

- For a sysplex that uses the coupling facility, you need to decide on the connections between coupling facility receiver and coupling facility sender channels. The connections can be established using the 'View CF channel path connectivity' action on the HCD 'Channel Path List' panel. See "Understanding a sysplex configuration" on page 2-10 for more information.
- On a z990 processor, you need to specify a two byte physical channel ID (PCHID) for each external channel in order to map the logical CHPID to its physical channel. You can specify them manually or use the zSeries CHPID mapping tool. You can get the CHPID mapping tool from ResourceLink at : <http://www.ibm.com/servers/resourceLink>

Note that internal channels, such as IQD do not require a PCHID.

- Description: text that you use to describe the channel path

When you define a channel path, you specify the processor to which the channel will be attached. Define the processor before defining the channel path that is attached to it.

Defining control unit data

To define control units in your configuration, you need to know the control unit type and model, such as 9343-1. You need to decide on:

- Control unit number, such as 0060
- Connections to switches
- Description: text that you use to describe the control unit
- Processor(s) that the control unit will be connected to
- On a z990, the logical channel subsystems that will have access to the control unit
- Information to attach the control unit to a channel path of the processor:
 - Channel path IDs
 - Link address
 - Unit address ranges that the control unit recognizes
 - Protocol
 - I/O concurrency level: classification of a control unit based on its ability to concurrently operate and control the activity of attached devices without causing loss of control or data.
 - Logical address, which is known as the CUADD value

Defining I/O device data

To define I/O devices in your configuration, you need to know the device type and model, such as 3420-7. You need to decide:

- The device number you want assigned to a device, for example, 0015. See "Specifying an I/O device number" on page 2-28 for considerations.
- Number(s) of the control unit(s) to which a device attaches.
- Device parameters and features for defining a device to an operating system, including whether the device supports dynamic configuration or whether a tape device is automatically switchable. See "Specifying I/O device parameters and features" on page 2-32 for more information.
- For esoteric device groups (that you named in the EDT as part of defining operating system data):
 - Which I/O devices you will include in each group
 - Which groups you want to make eligible for VIO. See "Defining devices as virtual I/O (VIO) eligible" on page 2-47.

- Any generic device types that you want to make eligible for VIO. See “Defining devices as virtual I/O (VIO) eligible” on page 2-47.
- Any changes you need to make to the device preference table for each EDT.
- The I/O devices that you will allow MVS to use as NIP consoles.

MVS needs a console to initialize the system. The console can be a device that you identified as a nucleus initialization program (NIP) console through HCD. For each I/O configuration, you can specify through HCD a list of the devices that can be used as a NIP console. During system initialization, MVS uses as the NIP console the first device in the list that is online and attached to the system.

If your processor has the console integration feature, you can use the system console to initialize the system, and you do not need to specify NIP consoles through HCD. ES/9000 9021, 9121, and 9221 processors have the console integration feature. For more information about the consoles that the operator uses to initialize an MVS system, see *z/OS MVS Planning: Operations*.

- Device parameters associated with the processor, such as unit address and preferred channel path ID. This information includes whether you want to control logical partition access to devices when logical partitions get access through a shared channel path. If you do want to limit logical partition access, you specify that you want an explicit device candidate list when asked by HCD. See “Defining logical partition access to a channel path” on page 2-19.

z990 processor considerations

The z990 processor supports the following:

- Up to 30 logical partitions on a z990 processor. The z990 only supports LPAR mode; you cannot run in basic mode.
- Multiple logical channel subsystems, which allow you to logically partition your physical channel resources to accommodate large-scale enterprise workload connectivity and high bandwidth demands. Each logical channel subsystem can have up to 256 CHPIDs and 15 logical partitions.
- Channels can be shared, or spanned, across logical channel subsystems. Spanned channels allow you to minimize the number of physical CHPIDs, switch ports and cables required. Channels that would otherwise be under-utilized could have their utilization increased by spanning them across LCSSs. See “Defining spanned channel paths” on page 2-24 for more information.

Support for the z990 processor on z/OS V1R4 consists of the following:

- z990 compatibility support allows your z/OS system to run on or coexist with systems running on the @server zSeries z990 processor. The z990 compatibility allows you to define multiple logical channel subsystems and up to 30 logical partitions, but z/OS can only run in and do a dynamic ACTIVATE of hardware changes for a logical channel subsystem of 0. See “Dynamically changing an I/O configuration on a z990 processor” on page 4-4 for details.
- Installing the z990 exploitation support lets you run your z/OS system on a z990 processor in a logical partition in any logical channel subsystem, and allows dynamic ACTIVATE of hardware changes for any logical channel subsystem.
- You can apply z990 compatibility and exploitation support to z/OS systems of version V1R1 and up. The z990 compatibility and exploitation support is built into V1R5 and later versions of z/OS.

Consider the following when running on a z990 processor:

- CHPIDs are not unique across multiple logical channel subsystems. To map a logical CHPID to a physical channel, you must specify a physical channel ID (PCHID).
- When you define a logical channel path, you must associate it with a logical CHPID on the HCD panels.
- Certain information for control units, such as channel paths and link addresses are defined for each logical channel subsystem for a processor.
- Channel path access and candidate lists are defined on a logical channel subsystem basis.
- On a z990 processor, the partition number and the MIF image ID are not the same. The partition number, assigned when you POR the machine, is based on information derived from IOCDs. The MIF image ID is assigned when you define the partition in HCD.
- You cannot change the number of logical channel subsystem or maximum number of devices for a logical channel subsystem without a POR.
- You no longer specify the expansion percentages for HSA on the CPC image profile on the hardware management console (HMC). The expansion percentages are replaced by the maximum number of devices value when you define each of the logical channel subsystems. If you want to change this value, you must POR the machine. The default for the maximum number of devices value for each logical channel subsystem is 63K, so plan carefully to avoid wasting HSA space.
- The device candidate list and preferred paths are defined on a logical channel subsystem basis.

Deciding about JES3 initialization stream checker data

Consider whether you need to create data that the JES3 initialization stream checker will use.

During the JES3 initialization process, you must define to JES3 the devices that JES3 manages. It is essential that the JES3 and MVS I/O configuration definitions be consistent. You can use the JES3 initialization stream checker to identify inconsistencies in the JES3 and MVS I/O definitions. The JES3 initialization checker looks for logical errors in the JES3 initialization statements.

The JES3 initialization stream checker can test for I/O definition consistency only if you supply data about the MVS I/O configuration definition. HCD enables you to write to a data set the MVS configuration data that the checker needs. You use the data set as input when you run the checker. See *z/OS JES3 Initialization and Tuning Guide* for more information about running the initialization stream checker.

To write the configuration data to the data set with HCD, you choose the “Create JES3 Initialization Stream Data” option on the HCD Activate and Process Configuration Data panel. On the HCD Create JES3 INISH Stream Checker Data panel, you specify the following information:

- Name of the data set that you created to contain the MVS configuration data to be input to the JES3 initialization stream checker
- Identifier of the operating system configuration and EDT for which you want to create the data set

Understanding a sysplex configuration

HCD offers you a single point of control for systems in a sysplex that includes a coupling facility for data sharing. A coupling facility is connected to the processors through channels. With HCD you can:

- Define the hardware and software configurations in a sysplex
- Manage IOCDs and IPL attributes across a sysplex
- Dynamically activate hardware and software configuration changes across a sysplex.

This section gives overview information about HCD definitions required with systems in a sysplex that includes a coupling facility. It also describes using HCD to manage IOCDs in a sysplex and configuring your tape devices in a sysplex. For information about how to dynamically activate configurations in a sysplex, see “Dynamically changing an I/O configuration in a sysplex” on page 4-7.

Defining coupling facility components in a sysplex

A coupling facility is a special logical partition that runs the coupling facility control code (CFCC) and provides high-speed caching, list processing, and locking functions in a sysplex. HCD enables you to specify whether a logical partition can be a coupling facility, operating system, or either on certain processors. You connect the coupling facility logical partition to a processor through the coupling facility channels as shown in Figure 2-3.

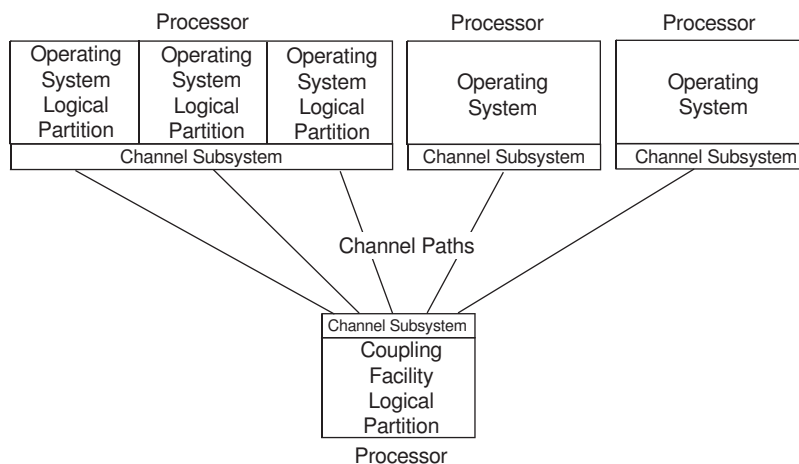

Figure 2-3. Example of a Sysplex

Using HCD, you define:

- A logical partition in which the coupling facility runs.
- Coupling facility (CF) sender channel paths and CF receiver channel paths or coupling facility (CF) peer channel paths. You define a coupling facility sender channel path to a logical partition running an operating system or a processor in basic mode running an operating system. You define a coupling facility receiver channel path to a logical partition running a coupling facility. On the IBM @server zSeries 900, you define CF peer channels on both sides of a coupling facility connection. A CF peer channel contains both sender and receiver functions. However, it is not required that these functions are used on both sides.

Note: With CF Duplexing a CF logical partition can use the coupling facility sender function to communicate with another CF logical partition. That means, you can define sender channel paths (CFS, CBS, ICS) besides the receiver channel paths (CFR, CBR, ICR) in a CF partition. CF Duplexing is supported in the 9672 Parallel Enterprise Servers G5 and G6 models and the z800, z900 and z990 zSeries™ models.

- Coupling facility control unit and devices. When you connect CF sender and CF receiver channel paths, or CF peer channel paths, HCD proposes coupling facility control unit and device numbers that must be defined for a CF sender channel. (CF receiver channels do not require control units and devices to be defined.) When you connect two CF peer channel paths, HCD proposes coupling facility control unit and device numbers on one or both sides of the connection depending on whether the sending function is used on only one or on both sides. You can override HCD's proposal to specify your own numbers for the control unit and device definitions.

These coupling facility control units and devices have different characteristics than control units and devices. The ones defined as a result of coupling facility connections are referred to as coupling facility control units and coupling facility devices.

Note: Regardless of the CF channel path type used for the coupling facility connection, HCD uses:

- Control unit type CFS and the device type CFS for the generated CF control units and CF devices specified for a CF sender channel path
- Control unit type CFP and device type CFP for the generated control units and CF devices specified for each of the CF peer channel paths

When you make connections between coupling facility channel paths, a coupling facility control unit and coupling facility devices are defined to represent the connections in the channel subsystem connection to the coupling facility. One coupling facility control unit is defined for each coupling facility that a processor connects to. For example, one control unit is defined when two logical partitions on a processor are connected to the same coupling facility partition. Two coupling facility devices are defined for each coupling facility path connection using CF sender and CF receiver channel paths. Seven coupling facility devices are defined for each connected CF peer channel path.

Coupling facility control units and devices are automatically defined by the CF sender-to-receiver or peer-to-peer connections that are established. You do not have to use the "Define Control Unit Data" option that you use to define control units and you do not have to use the "Define Device Data" option that you use to define I/O devices. See "Making changes to coupling facility devices and control units" on page 4-16 for information about changes to the coupling facility definitions.

The characteristics that distinguish coupling facility components are:

- UIMs are not needed for coupling facility devices
- Coupling facility devices are not represented by UCBs
- An EDT and dynamic allocation do not pertain to coupling facility devices
- You do not select a preferred channel path to a coupling facility device
- You do not vary coupling facility devices offline
- Channel measurement blocks (CMBs) do not apply to coupling facility devices
- You cannot specify a unit address for a coupling facility device
- The concept of logical versus physical control unit does not apply

- You cannot specify a logical address for a coupling facility control unit.

Coupling facility (CF) channels can be defined as Intersystem Coupling (ISC) channels or as Integrated Cluster Bus (ICB) channels. The channel path types used for ISC channels are CFS for the coupling facility sender channel, CFR for the coupling facility receiver channel, and CFP for the coupling facility peer channel. The channel path types used for ICB channels are CBS for the coupling facility sender channel, CBR for the coupling facility receiver channel, and CBP for the coupling facility peer channel.

For testing purposes, you can use a central processor complex (CPC) in the following processors to simulate coupling facility channels:

- S/390 9672 Parallel Enterprise Server
- S/390 Application StarterPak (3000 models)
- S/390 Multiprise 2000 (2003 models)
- S/390 Multiprise 3000 (7060 models)
- IBM @server zSeries 800
- IBM @server zSeries 900
- IBM @server zSeries 990

You do not define coupling facility channel paths, a coupling facility control unit, or coupling facility devices for the logical partitions that use ICMF. ICMF automatically generates an appropriate configuration of integrated coupling facility paths, coupling facility control units, and coupling facility devices for the logical partitions to use.

With ICMF, if possible, avoid using the channel path identifiers, device numbers, or control unit numbers shown in Table 2-1 for your I/O component definitions. ICMF uses these numbers when it simulates the coupling facility components.

Table 2-1. I/O Component Identifiers To Avoid When Using ICMF

Component Definition Information	Avoid Using These Numbers
channel path identifier	F0 and F1
control unit number	FFFF and FFFE
device number	FFFF, FFFE, FFFD, FFFC

As an alternative to ICMF, you can use Internal Coupling (IC) channels to allow an operating system image to communicate with a coupling facility image in the same CPC without requiring any hardware resources. Using IC channels is very similar to ICMF except for the following:

- CP microcode, not LPAR code, provides the coupling communication.
- Coupling channels can also be configured into either image along with Internal Coupling (IC) channels that need to be defined.

Except for channel packaging and providing connection information, IC channels follow the same configuration rules as real coupling facility channels (ISC or ICB).

Because you need no real hardware to perform IC functions, define IC channels with CHPID numbers that are not installed or are unusable because of other installed hardware.

Define the IC channels with the following types:

- CF sender channel with type ICS
- CF receiver channel with type ICR

- CF peer channel with type ICP

Reconfiguring coupling facility receiver CHPIDs

You can reconfigure CF receiver CHPIDs to change the association between an z/OS image and a coupling facility (CF) logical partition without the overhead of a power-on-reset (POR). An operator command configures the CHPID to a different CF partition.

Reconfiguring CF receiver CHPIDs is intended for preplanned configuration changes that require the movement of CF channel capacity. This function is also useful in recovery situations; you can, for example, move channel capacity from lower priority work, such as test, to higher priority work, such as production.

There are restrictions on configuration definitions for reconfigurable CF receiver CHPIDs. The configuration rules for dedicated CF receiver CHPIDs, however, are not changed.

To understand the reconfiguration restrictions, you need to understand what "same z/OS image" means in the context of CF sender CHPIDs. The definition depends on whether the CF sender CHPID being connected is a dedicated or reconfigurable path, or a shared path:

- Both dedicated and reconfigurable CF sender CHPIDs belong to the same z/OS image if the CHPIDs have identical access lists. Any connects of these CF sender CHPIDs are made from the same z/OS image.
- Shared CF sender CHPIDs are treated as if they belong to the same z/OS image if there is at least one partition in common to all the CF sender channels. Any connects of these shared CF sender CHPIDs are made from the same z/OS image.

Restrictions: Reconfiguring CF receiver CHPIDs requires two CF partitions:

1. The source CF partition that had initial access to the CF receiver CHPID at power-on-reset (POR)
2. The target CF partition that has access after CF receiver CHPID reconfiguration

The CF partition specified in the access list is the source CF, and the CF partition specified in the candidate list is the target CF.

The following restrictions apply:

- When you define a reconfigurable CF receiver CHPID, specify only a single CF partition, the source CF, in the access list and only a single CF partition, the target CF, in the candidate list.
- You can define reconfigurable and dedicated CF receiver CHPIDs in the same CF partition:
 - You must define as dedicated any CF receiver CHPID initially accessed within a target CF logical partition.
 - You can define as dedicated or reconfigurable any CF receiver CHPID in a source CF logical partition as long as all connects from the same z/OS image are to CF receiver CHPIDs that are either all dedicated or all reconfigurable.
- You must reconfigure both CF sender CHPIDs and CF receiver CHPIDs together as part of a planned reconfiguration. If you reconfigure them separately, results are unpredictable.
- All connects from the same z/OS image to CF receivers with the same access list must have the same candidate list. All CF receiver CHPIDs that are

connected from the same z/OS image to the same source CF partition must be reconfigured to the same target CF partition.

- All connects from the same z/OS image to CF receivers with access lists that are different from any previous connection must have candidate lists that are different from any previous connection. All CF receiver CHPIDs that are connected from the same z/OS image to different source CF partitions must be reconfigured to different target CF partitions.
- All connects from different z/OS images to CF receiver CHPIDs with the same access list can have the same or different candidate lists. Not all CF receiver CHPIDs from the same source CF logical partition need to be reconfigured to the same target CF logical partition.
- All connects from different z/OS images to CF receiver CHPIDs with different access lists can have the same or different candidate lists. A target CF partition can have CF receiver CHPIDs reconfigured to it from many source CF partitions.

Reconfiguring coupling facility peer CHPIDs

A CF peer channel path may specify both z/OS images and CF logical partitions in its access and candidate lists. You can define a CF peer channel path as dedicated, reconfigurable, shared, or spanned. For a dedicated CF peer channel path, you can specify only one logical partition, running either an operating system image or a coupling facility. When you define a CF peer channel path as a reconfigurable, shared, or spanned, you can specify only one CF logical partition in its access list and one additional CF logical partition in its candidate list.

A coupling facility connection using CF peer channels must specify at least one z/OS image on one CF peer channel while the other CF peer channel must specify at least one CF logical partition. It is possible for each CF peer channel path of the connection to specify a CF logical partition.

With respect to the sender and receiver functions, the restrictions for reconfiguring CF peer channels in CF logical partitions are analogous to the CF receiver channel path restrictions described previously.

Managing IOCDSs and IPL attributes across a sysplex

You can control the following processors through a Hardware Management Console:

- S/390 9672 Parallel Enterprise Server R2 and R3 models, as well as Generation 3 (these processors will run OS/390 Version 2 Release 10, but not z/OS V1R1 or higher)
- S/390 9672 Parallel Enterprise Server G5 and G6
- S/390 Application StarterPak (3000 models)
- S/390 Multiprise 2000 (2003 models)
- S/390 Multiprise 3000 (7060 models)
- IBM @server zSeries 800
- IBM @server zSeries 900
- IBM @server zSeries 990

HCD allows you to manage their IOCDSs and update their IPL parameters from a single point of control. On the HCD panels, these processors are referred to as an S/390 microprocessor cluster. You build IOCDSs and update IPL parameters for each central processor complex (CPC) in a S/390 microprocessor cluster.

The Hardware Management Console consists of a hardware management console application (HWMCA) running on a PS/2[®] and a token ring LAN connected to the support element of each S/390 9674 Coupling Facility and the support element of

each CPC in an S/390 microprocessor cluster. Figure 2-4 shows an example of support elements connected to a Hardware Management Console.

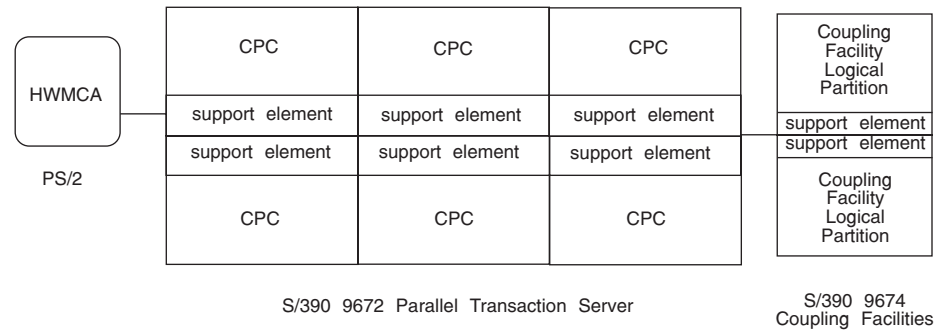

Figure 2-4. Support Elements connected to the Hardware Management Console

The system network architecture (SNA) address of the support element identifies the attached CPC to the Hardware Management Console.

HCD uses the SNA addresses to enable you to perform, from a single system, IOCDS management for any processors listed at the beginning of this topic. You can also use HCD to view and update the IPL address and LOAD parameter values for the next IPL. These values are used when IPLADDR(NEXT) and IPLPARM(NEXT) are specified on a load profile that is used to activate an operating system.

To enable these functions, you specify the SNA address of the support element. You specify the SNA address on the HCD Add Processor panel when you define any processors listed at the beginning of this topic. An IODF processor configuration has to be defined for each CPC in an S/390 9672 Parallel Transaction Server. HCD provides a prompt facility that lists the SNA addresses for the currently active support elements.

Notes:

1. Before you can use HCD to manage IOCDSs from a single system, you must use the Hardware Management Console to configure the processors. See *Hardware Management Console Guide* for information about using the Hardware Management Console.
2. For HCD IPL address and LOAD parameter changes to be effective, the processor activation profiles set up with the Hardware Management Console must allow dynamic changes. See *Support Element Operations Guide* for more information about CPC activation profiles.
3. To view IOCDS status in HCD, you need READ authority to the CBD.CPC.IOCDS resource in the RACF® FACILITY class. UPDATE authority is required to change IOCDS status information. To view IPL attributes, you need READ authority to the CBD.CPC.IPLPARM resource in the FACILITY class. UPDATE authority is required to change IPL attributes. When the CBD.CPC.IOCDS resource is defined in the FACILITY class, the operator message asking for approval to write an IOCDS is no longer issued when someone attempts to write an IOCDS. Only users with UPDATE authority to the CBD.CPC.IOCDS resource will be able to write an IOCDS.

If a security product is not in operation, the HCD IOCDS management and IPL attribute functions are not available.

See *z/OS HCD User's Guide* for more information.

4. Only the processor that HCD is running in has to be operational to perform HCD IOCDS management and IPL attributes functions. As long as HWMCA and the support elements are operational, HCD can perform these functions on the other support elements even if the processors attached to these support elements are powered off.

Using automatic tape switching

When you configure your tape devices in a sysplex, you must consider whether to have all your tape drives on one system, or whether you will spread them out. You can share tape devices across many systems, both with and without the need for manual intervention by the operator. IBM offers the following ways for many systems to use the same tape devices. A tape device can be:

- A **dedicated tape device** is varied online to one system at a time. For a second system to use that same device, an operator issues VARY commands (first VARY OFFLINE, then VARY ONLINE) to make the device available to the second system. In this book, tape devices are assumed to be dedicated unless specified otherwise.
- An **automatically switchable tape device** can be online to more than one system at a time. For one system to use an automatically switchable tape device, then another system to use the same device, an operator does not have to issue any VARY commands. When the system selects that device for allocation to a job step, the device is at once both assigned to the specific system and allocated to the job step. Automatically switchable tape devices require that the systems in the sysplex communicate with each other either through the IEFAUTOS coupling facility structure prior to z/OS Release 2 or with the ATS STAR method available with z/OS Release 2 (with APARs OW51103 and OW50900 installed) and higher.

Automatic tape switching (that is, using automatically switchable tape devices) can benefit a sysplex by:

- Requiring fewer tape devices in a sysplex
By using automatically switchable tape devices, you can reduce the overall number of tape devices needed by a sysplex. With tape devices easily available to multiple systems, a sysplex can use its tape resources more efficiently.
- Reducing operations cost
Automatic tape switching can reduce operating costs by managing tape drives at the sysplex level and eliminating costly operator intervention.

For a system to consider a device automatically switchable, these conditions must be true:

- The device must be defined as automatically switchable.
You can define the device as automatically switchable through HCD.
You can issue the VARY *devnum* AS ONLINE command when the device is offline, and then VARY it online.
- The device must be varied online through the VARY ONLINE command or the IEEVARYD macro.

A system not participating in automatic tape switching but connected to a device that is defined as automatically switchable can vary that device online. During the time the device is online to the nonparticipating system, the device is not available to the participating systems. After the device is varied offline, it becomes available to participating systems.

Before you make the final decisions related to using automatic tape switching, read the rest of this section and see *z/OS MVS System Commands* for considerations for the operations staff who define automatically switchable devices and respond to problems.

Automatic tape switching in release 2

The ATS STAR design in z/OS R2, with APARs OW51103 and OW50900 installed, improves the availability and system management characteristics of the prior automatic tape switching function. The ATS STAR design drops the use of the IEFAUTOS coupling facility structure and instead uses global resource serialization and XCF services to maintain serialization when allocating shared tape devices. Both ATS STAR and the IEFAUTOS function can coexist in a sysplex composed of z/OS R2 and levels of z/OS and OS/390 lower than z/OS R2, and will properly maintain the integrity of the allocation of shared tape devices across the mixed sysplex. Systems at a level lower than z/OS R2 will continue to use the IEFAUTOS structure and systems at R2 with the required APARs will use the ATS STAR function. Once all systems sharing the device are at the updated R2 level, the IEFAUTOS structure can be removed from the CFRM policy. To maximize the performance of the ATS STAR function, it is strongly recommended that you use the global resource serialization Star configuration, rather than the Ring configuration.

Coexistence of the ATS STAR and IEFAUTOS functions is enabled by having the system maintain information about the use of an autoswitchable device in either the Allocation address space (ALLOCAS) or in the IEFAUTOS structure. The two functions act independently of each other, each as a subset of the systems in the sysplex. When a device is in use by a system in either subset, the device will appear as "Assigned to Foreign Host (AFH)" to any other system that is not a member of that subset.

Toleration support for the ATS STAR function is required for users of the Multi-Image Integrity (MII) and Multi-Image Allocation (MIA) functions of Computer Associates Multi-Image Manager (MIM). Contact Computer Associates for the associated support.

Steps to setting up automatic tape switching

Setting up automatic tape switching requires you to:

- Decide how many automatically switchable devices to define; see "Deciding how to use automatically switchable devices."
- Define tape devices as automatically switchable; see "Defining a tape device as automatically switchable" on page 2-34.

Deciding how to use automatically switchable devices

The system programmer determines the appropriate balance of dedicated devices and automatically switchable devices to meet the installation's needs. Factors that affect the decision are:

- The number of systems in the sysplex
- The number of devices that are eligible for automatic tape switching. Automatic tape switching requires "assign-capable" tape devices, such as 3490 or 3480 tape drives.
- The systems' workloads and the number of jobs requiring tape devices.
- Whether the installation has other ways to manage devices, such as JES3 or a vendor product.

Generally, tape devices that are already available to multiple systems and used periodically but not constantly are candidates for being defined as automatically switchable. These devices can be used more efficiently when available to any or all systems in the sysplex.

You might have good reasons to have a mixture of dedicated and automatically switchable devices in an installation. Consider the following example that shows a good way of splitting up your tape devices. In our example, a computing environment includes:

- A 9021 711-based processor that runs the company's large batch applications
- An S/390 microprocessor cluster that runs a CICS® OLTP workload
- A coupling facility that connects the 9021 711-based processor and the S/390 microprocessor cluster
- 60 3490 tape devices

Because of their heavy demand for storage, the batch jobs on the 9021 711-based processor need the majority of the tape devices. The CICS applications have occasional and short-term need for tape devices. Rather than having an operator vary the tape devices online and offline as the systems' requirements for tape devices change, divide the tape devices so that the batch work and the CICS workload use the tape devices as follows:

- 50 of the devices are dedicated to the batch work on the 9021 711-based processor.
- 10 of the devices are automatically switchable across the systems in the S/390 microprocessor cluster.

Operational considerations for automatic tape switching

The operations staff is responsible for varying the automatically switchable devices online. They also must respond to messages that describe problems caused during automatic tape switching.

In *z/OS MVS System Commands*, the operations staff can find out how to:

- Define automatically switchable devices
- Display information about automatically switchable devices
- Respond to automatic tape switching events

Defining shared channel paths

This section provides background information that is helpful if you are defining shared channel paths in your I/O configuration.

Multiple Image Facility (MIF) capability enables logical partitions to share channel paths, such as ESCON, FICON, and coupling facility sender channel paths, between logical partitions within a processor complex. If a processor complex has MIF capability, and is running in LPAR mode, all logical partitions can access the same shared channel paths, thereby reducing the number of required physical connections. In contrast, if a processor complex does not have MIF capability, all logical partitions must use separate channel paths to share I/O devices.

Figure 2-5 on page 2-19 compares three unshared channel paths to a single shared channel path. In processor complex A, three logical partitions can access an I/O device through three unshared channel paths. In processor complex B, which has MIF capability, three logical partitions can access an I/O device through a single shared channel path.

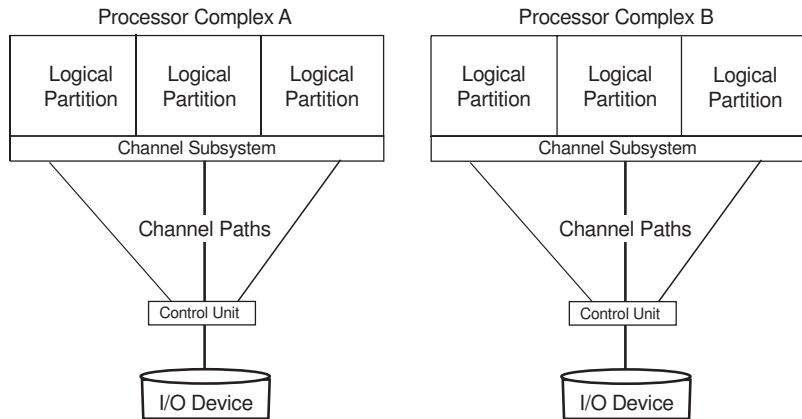

Figure 2-5. Shared Channel Paths

Considerations for sharing channel paths

Before using shared channel paths, you need to consider the following:

- ESCON and FICON channel paths can be shared; ESCON converter channel (CVC) paths and ESCON converter byte (CBY) channel paths cannot be shared. OpenSystem adapter (OSA) channels, OSA-Express channels (OSD and OSE), CF peer channels, coupling facility sender (CFS/CBS/ICS) channel paths, and ISD channel paths can be shared. CF sender channel paths can also be dedicated or reconfigurable. Coupling facility receiver (CFR/CBR/ICR) channel paths can only be dedicated, though they can be defined as reconfigurable for the recovery scenario.
- Using shared ESCON and FICON channel paths does not reduce the number of logical paths needed at a control unit. A control unit requires a logical path for each logical partition that can access a shared channel path. For example, in Figure 2-5, the control units shown connected to processor complexes A and B both require three logical paths for the three logical partitions.
- The performance characteristics (for example, response time and throughput) as observed by each logical partition sharing a channel path depend on the total workload on the channel path. You can use multiple shared channel paths to provide adequate performance and recovery capabilities for critical I/O devices.

Defining logical partition access to a channel path

When a channel path is attached to a processor in LPAR mode, you can use HCD to specify which logical partitions have access to the channel path. You specify access by including a logical partition on the following channel path lists in HCD:

channel path access list

A logical partition that is on a channel path's access list can access the channel path when the logical partition is initially activated at POR. When a channel path is dedicated or reconfigurable, you specify one logical partition on the channel path access list. When a channel path is shared, you can specify more than one logical partition on the channel path access list.

channel path candidate list

A logical partition that is on a channel path's candidate list can eventually

access the channel path. A logical partition on this list can access the channel path when the channel path is configured online to the logical partition

Note: HCD automatically considers a logical partition in an access list to be in the candidate list so you do not need to also enter a logical partition in the access list into the candidate list.

The operation mode of the channel (dedicated, reconfigurable, shared or spanned) determines the need for a candidate list. Dedicated channel paths are not reconfigurable so they do not need a candidate list. If no logical partitions are specified on an access list for a reconfigurable, shared or spanned channel path, then you specify logical partitions on the candidate list. Also for a shared or spanned channel path, if all the logical partitions are specified on the access list, they are all sharing the channel path initially so a candidate list is not necessary. However if not all the logical partitions are specified on the access list, a logical partition may be able to access the channel eventually if the logical partition is on the channel path candidate list.

When you define a device, HCD and MIF and IOCP also allow you to control logical partition access on a device level. A device might be attached to a control unit that uses a shared or FICON channel path. You can specify that only certain of the logical partitions sharing the channel path have access to the device.

To limit logical partition access, you specify that you want an explicit device candidate list when you define a device. On the device candidate list, you indicate the logical partitions that share the ESCON or FICON channel path(s) that can access the device. When you do not specify a device candidate list, all the logical partitions that share the ESCON or FICON channel path to the device can access the device. For a logical partition to use the device, the logical partition would have to be in the access list or candidate list of a channel path going to the device.

Sharing channel paths provides flexibility and reduced cost for an installation when defining an I/O configuration. An installation selects which I/O devices to access through shared channel paths, and can define and dynamically change which partitions have access to these channel paths and to the devices connected to them.

Notes:

1. When dynamically activating a configuration that adds a partition to the access list of a channel path, you must configure the channel path online to the partition, using the CONFIG command. You must use the CONFIG command at least once; afterward, PR/SM will configure the channel path to the partition during subsequent PORs. See *z/OS MVS System Commands* for information about the CONFIG command, and see *PR/SM Planning Guide* for information about the CHPID command and for a description of automatic configuration of channel paths to partitions.
2. Managed channels must be associated with a specific sysplex, and only images that are members of that sysplex can use them. The channel path access list and channel path candidate list cannot be specified for managed channels. See “Defining dynamically managed channel paths” on page 2-22 for more information.

Processors communicating through shared ESCON or FICON channel paths

ESCON CTC connections

An ESCON channel-to-channel (CTC) channel path has an ESCON CTC connection at one end, and either an ESCON (CNC) or FICON (FCV) channel connection at the other end. For any two processor complexes to communicate through an ESCON channel path, the ESCON CTC connection can be at either processor complex.

To communicate from a processor complex to a logical partition through an ESCON CTC channel path attached to a shared ESCON channel path, you must specify the logical address of the ESCON CTC (SCTC) control unit that represents the target system. As shown in Figure 2-6, the logical address is the number of the target logical partition. As explained in *z/OS HCD User's Guide*, you can specify partition numbers when defining partitions, and you can specify these partition numbers as the logical address for a CTC control unit. For more information about communicating through ESCON CTC channel paths, see *ESCON and FICON CTC Reference*. In the following example LP 1 has been assigned partition number 1, LP 2 has been assigned partition number 2, and so on.

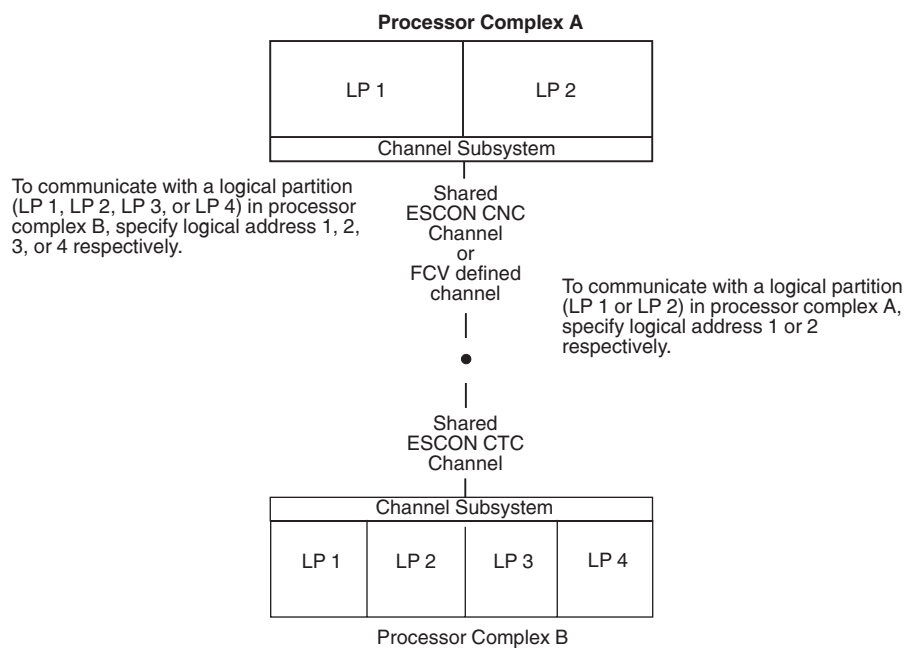

Figure 2-6. Logical Addresses and Logical Partition Numbers

You specify a logical address when you define a control unit in HCD. A logical address is not applicable for a coupling facility control unit.

FICON CTC connections

Processors at the IBM @server zSeries 900 level and above exploit the FICON capability to provide channel-to-channel host communication between processors. An FCTC connection to a processor earlier than IBM @server zSeries 900 (G5/G6 processors) is only possible if one of the two FC channel paths that perform the FCTC connection is defined on an IBM 2064 or later CPC. FICON CTC (FCTC) provides CTC communication at a higher bandwidth and with greater connectivity than with ESCON CTC. Unlike the ESCON CTC, the FICON CTC does not require that you explicitly define the CTC control unit function to one channel side or the

other. The channel itself decides which side will contain the control unit function. That means, both sides of an FCTC connection use an FC channel path that is defined to one or more FCTC control units representing the target systems for the CTC connections. Like the ESCON CTC, a logical address is required when the FC channel path is attached to a shared FC channel path to identify the logical partition to be communicated with. When attached to an unshared FC channel path, the logical address must be zero or not specified. FICON CTC communication within a single processor complex can be accomplished with a single FC channel path connecting to an FC switch, that is, both sides of the CTC connection are represented by the same single FC channel path. This results in:

- A reduction in the number of channels required
- A simplified configuration design
- A simplified configuration definition

ESCON or FICON CTC connections that are defined via a switch can be validated and reported in HCD (see the CTC Connection Report in *z/OS HCD User's Guide*. When using HCM, a separate dialog is provided for defining CTC connections. See *z/OS and z/VM HCM User's Guide*.

Defining dynamically managed channel paths

An integral part of the Intelligent Resource Director, introduced in z/OS Release 1, is dynamic channel path management. Instead of defining a fixed number of channel paths to control units, this function lets Workload Management (WLM) move channel paths through the ESCON Director from one control unit to another, in response to changes in the workload requirements. By defining a number of channel paths as "managed," they become eligible for this dynamic assignment.

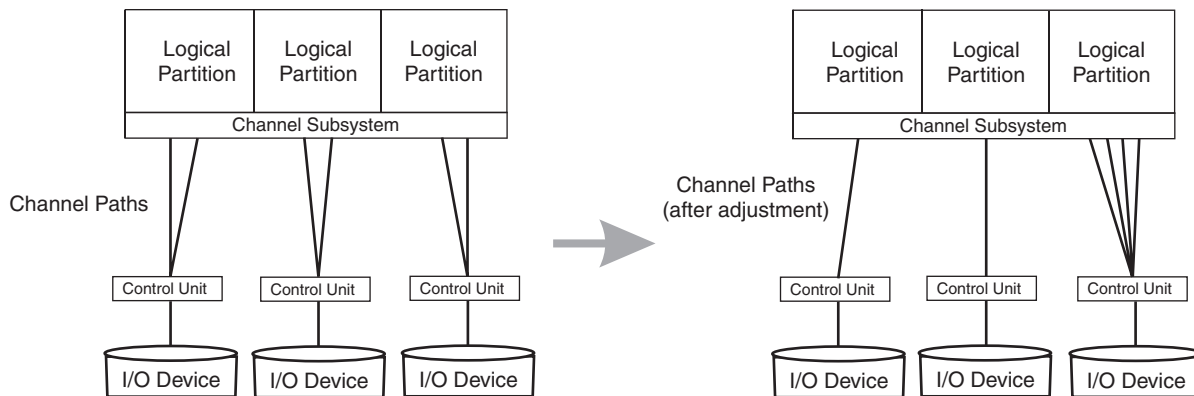

Figure 2-7. Dynamic Channel Path Management

Dynamic channel path management works in two modes: *goal mode* and *balance mode*. In goal mode, available only when WLM is running in goal mode, dynamic channel path management will manage the channel paths to best meet the performance goals of the most important work, even at the expense of less important work, if necessary. In balance mode, available whether WLM is running in goal mode or compatibility mode, dynamic channel path management will simply attempt to balance the responsiveness of all the DASD subsystems, moving dynamic channels as needed.

Dynamic channel path management is allowed only on an IBM 2064 (IBM @server zSeries 900) or later CPC. HCD will ensure that no managed channel paths are connected to a CPC prior to this level.

The Intelligent Resource Director allows an installation to group logical partitions that are resident on the same physical server, and in the same sysplex, into an “LPAR cluster.” This gives Workload Management the ability to manage resources, both processor and DASD I/O, not just in one single image but across the entire cluster of logical partitions. To use dynamic channel path management, the CPC can be running in either basic or LPAR mode. In basic mode, a coupling facility is not needed, as there will be no logical partitions grouped together in an LPAR cluster. In LPAR mode, a coupling facility is required if you wish to use dynamic channel path management in any logical partition containing a system that is a member of a multisystem complex (even if the logical partition is the only member of that sysplex on this CPC). You do not need a coupling facility if all the logical partitions are running in XCFLOCAL or MONOPLEX mode.

Important

Dynamic channel path management will only support non-synchronous control units, such as the Enterprise Storage Server™. A non-synchronous control unit transfers data with the host directly to and from the control unit’s cache. It will *not* support synchronous control units, or control units that are synchronous on occasion, such as the 3990. The 3990 is a non-synchronous control unit most of the time, but there are situations where it will transfer data to or from the device directly. Dynamic channel path management will only support 100% non-synchronous control units.

The IBM Redbook *z/OS Intelligent Resource Director* (SG24-5952) provides extensive guidance on choosing the appropriate channels and control units for dynamic channel path management. In overview, the installations most likely to benefit are the following:

- Installations approaching the 256 channel limit per CPC (or 256 per logical channel subsystem on a z990)
- Smaller installations that do not have sufficient technical resources to design and monitor DASD subsystems
- Installations that experience large variations in channel utilization at different times of day
- Installations where the highest possible availability is an absolute requirement
- Installations with a large number of control units, and multiple control units, per channel
- Installations with a large number of EMIF channels.

Once you have selected the appropriate channels and control units for dynamic channel path management, there are two HCD definitions that will need to be changed: the channel definitions and the control unit definitions.

To define a channel as being managed, you must specify YES in the “Managed” field on the “Add Channel Path” HCD panel. You must also specify a dynamic switch (in this case, the ESCON Director) to which the channel is attached. It is recommended that you also specify the entry switch ID and entry port so that HCD can do consistency checking.

If you are running in LPAR mode, you must also define the name of the LPAR cluster to which a logical partition must belong in order to have this channel in its configuration. Specify this name in the “I/O Cluster” field. Finally, you must also define this channel as being shared. Note that unlike traditional shared channels

which potentially can be shared by all logical partitions on a CPC, managed channels can only be shared by logical partitions in the same LPAR cluster.

To define a control unit as managed, you must make changes to its definition in the “Add Control Unit” HCD panel. Whereas non-managed channel paths (otherwise called “static” channel paths) are defined in the traditional way, via the CHPID number, a managed path is defined by specifying an asterisk (“*”). The number of asterisks you specify will limit the number of managed channel paths per CPC, or managed channel paths per logical channel subsystem on a z990. The total number of non-managed and managed channel paths per CPC, or managed channel paths per logical channel subsystem on a z990, cannot exceed 8. On a z990, you must define the managed channel path to the control unit in the definition of each logical channel subsystem.

Important

You must define at least one non-managed channel path (which must be defined as shared) per control unit.

The control unit must be attached to a switch (again, in this case an ESCON Director) which in turn must be attached to managed channels.

See the *z/OS HCD User's Guide* for more information on using these panels to define managed channels and control units.

Defining spanned channel paths

This section provides background information that is helpful if you are defining spanned channel paths in your I/O configuration. Spanned channel paths are only allowed on a z990 processor.

A shared channel path can only be shared by partitions in a single logical channel subsystem. In contrast, a spanned channel path is one that can be used by partitions in more than one logical channel subsystem. You must use the same CHPID value across all logical channel subsystems sharing the same spanned channel. However, logical channel subsystems that do not share a spanned channel can use that CHPID for other channels.

See also “Dynamically changing an I/O configuration on a z990 processor” on page 4-4 for more information.

Considerations for spanning channel paths

Before using spanned channel paths, you need to consider the following:

- Spanned CHPIDs still use access and candidate control lists to restrict access within the logical channel subsystem.
- Spanning reduces the number of channels that can be used. For example, on a z990 processor, you can have up 512 channels available if you define two logical channel subsystems. However, each logical channel subsystem that has access to the spanned channel is using one of those 512 CHPIDs. So, if you have not defined any spanned channels, you have 512 channels available. If you define one channel as spanned across these 2 logical channel subsystems, you'll have only 511 channels available (512 - 2 used CHPIDs + 1 spanned channel). If you span all of your channels across all of your logical channel subsystems, you'll have 256 CHPIDs.

- Not all channel types can be defined as spanned. On z990 processors, only IQD and Internal Coupling peer channels can be defined as spanned.
- Managed channels cannot be defined as spanned.

FICON channels

FICON (fibre connection) channels increase the capacity of the channel subsystem; each FICON channel can replace up to eight ESCON channels.

Channel path definitions

You can define Fibre Channels in two ways:

- The FCV (Fibre Channel) channel that uses a FICON Bridge offers a migration path for ESCON CNC channels. Using the FICON Bridge Feature on the 9032-005 ESCON director, you can attach ESCON devices to the FCV channel.
An FCV channel path occupies eight port addresses on the switch. To model the FCV bridge within HCD, consider the following. Whenever you connect an eligible port address to an FCV channel path, you must set all other port addresses occupied by the FCV bridge to uninstalled.
- The FC (Fibre Channel) channel requires a FICON interface at the control unit. FC channels can be attached directly to a control unit (point-to-point) or via a Fibre Channel (FC) switch.

You can attach FICON channels only to the S/390 G5 Server 9672 (GA-3) and later processors.

Dynamic activation

There are no restrictions on dynamically activating an IODF that defines FCV or FC channel paths.

Migration

Both HCD and HCM offer migration functions you can use to convert CNC channel paths to FCV channel paths, or to convert ESCON attachments (CNC or FCV) on the control unit to FICON attachments (FC).

Migrating from CNC to FCV channel paths

The HCM migration function includes three utilities. These utilities provide the ability to convert the CHPID type from CNC to FCV, to move ESCON port attachments effectively on the ESCON director, and to aggregate CNC CHPIDs onto an FCV CHPID.

The HCD migration function includes two dialogs, described in the following procedure for converting CNC channel paths to FCV channel paths. The procedure assumes that you have already decided which CNC CHPIDs you want to converge to a single FCV channel path and which ESCON director ports you will use for the FICON Bridge feature card.

Note: The FICON Bridge feature occupies eight contiguous port addresses on the ESCON director, starting with port address x4 or xC. HCD requires you to connect the FCV channel path to the first port address and set the following seven port addresses to uninstalled.

Once you have completed your planning, take the following steps:

1. Free the ports used by the FICON Bridge feature card.

Disconnect the ports to be freed from the connecting units and connect them to a target port. At the same time, change the corresponding logical definition (such as link address or dynamic switch). Depending on your configuration, this step includes:

- Moving CHPIDs that are connected to either port to another (free) port, and possibly to another switch, by updating the entry switch/entry port data in the channel path definition. When you move the channel path to a new switch, you must also change the dynamic switch, and move the connected control units to the new switch as well.
- Moving control units that are connected to either port to another (free) port, and possibly to another switch, by updating the connected switch/port data in the control unit definition. You must also change the link address. When you move the control unit to a new switch, you can move the connected channel paths to the new switch as well, and update the channel paths accordingly.
- Moving switch-switch connections to another free port. On the switch port list, disconnect the switch from the port and connect it to another port. To move a switch-switch connection, you might need to change the link address on control units that are accessed through a dynamic connection to the port to be freed, and move related channel path ports and control unit ports.

To perform this step in HCD, select the Move Ports action from the Switch List panel.

2. Change the switch matrixes to match the changed connections.

If you are moving ports on the same switch, using the Port Move dialog, HCD automatically updates the switch configuration. If you are moving ports between different switches, you must update the switch configuration(s) of the target switch.

3. Define the FCV channel path.

If the channel path you want to converge to the FCV channel path is already defined with a CNC CHPID, change the CHPID type from CNC to FCV.

If a channel path is already defined with the ID selected for the FCV CHPID, and you cannot or should not aggregate this CHPID to the FCV channel path, change the ID of the existing channel path.

Defining an FCV channel path might require you to change the IDs of other channel paths on the same channel card to conform to channel packaging rules.

4. Connect the FCV channel path to the FCV entry port.

There is an entry port prompt on the Define Channel Path panel and on the Change Channel Path panel. This prompt shows the free ports on the entry switch, that are eligible to connect to FCV channel paths. For a switch configuration with an FCV channel connection, the following rules apply:

- The FCV port must not have a dedicated connection defined.
- If other FCV channel paths are connected to other ports, defining dynamic connections between any two of these ports is prohibited.

5. Aggregate other CNC channels to the FCV CHPID.

To aggregate other CNC channel paths to the FCV channel path, you must (1) disconnect the control units connected to the CNC channel path from the CNC CHPID, then (2) connect the control units to the FCV CHPID.

Depending on the access and candidate lists of the FCV channel path and the CNC channel path to be converged, you might have to update the device candidate lists. For example, the target FCV CHPID might be defined as shared, and the CNC channel path to be converged might be defined as dedicated or reconfigurable.

If the devices connected to the channel paths that are aggregated have a preferred CHPID defined, you must update the preferred CHPID.

To perform this step in HCD, proceed as follows:

- On the Channel Path list, select the FCV channel path and apply the AGGREGATE CHPID action.
- On the Aggregate CHPID dialog, you can enter one CHPID at a time to be aggregated to the selected FCV channel path. Use the prompt to see the channel paths that are eligible for the aggregation. For conditions that must be met for a CHPID to be eligible for the aggregation, see the HCD on-line help.
- Set the ports following the FCV entry port, the ports that the FICON Bridge feature card will use, to uninstalled. If necessary, disconnect the aggregated CNC channel paths from the switch to free these ports.

Migration from CNC or FCV to FC channel paths on the control unit

You can seamlessly migrate from CNC or FCV to FC channel path attachments on the control unit (for example, on an ESS 2105 Control Unit) without varying the devices offline. You do this by the following steps:

1. Dynamically add an FC channel path to the existing list of channel paths that includes an ESCON channel path on the same (logical) control unit.
2. Configure the FC channel path online. The system routes the I/O requests via either the ESCON or the FICON channel attachments.
3. Configure the CNC/FCV channel paths offline so that I/Os are now directed via the FC channel path.
4. Dynamically delete the CNC/FCV channel paths.

With some restrictions, you can intermix ESCON and FICON channels on the same logical control unit. HCD supports the ESCON/FICON channel intermixture on the control unit according to the following rules:

- Intermixing FC channels with CNC and FCV channel paths should be temporary, and done only for migration purposes. This mixture is not recommended for production.
- Both the processor model and the control unit type must support the mixture of ESCON and FICON channel paths.
- If a control unit contains a mixture of CNC/FCV and FC channel paths, it is regarded as an ESCON control unit and validated according to the rules for ESCON control units, such as attachment limits.
- If a control unit attaches only to FC channel paths, it is regarded as a FICON control unit and validated according to the FICON control unit rules.

To determine the level to which your control units and devices support intermixing, see their device planning manuals. For those control units that do support intermixing, please consult their performance whitepapers for guidance on how to best configure channels from a performance perspective. To improve the balance of workload across channels in an intermixed environment, IBM recommends that you alternate ESCON (CNC and FCV) and FICON (FC) channel paths in the control unit using the following patterns:

- For 6 ESCON and 2 FICON, use a sequence of E, E, E, F, E, E, E, F
- For 4 ESCON and 4 FICON, use a sequence of E, F, E, F, E, F, E, F
- For 2 ESCON and 6 FICON, use a sequence of E, F, F, F, E, F, F, F

Defining IQD CHPIDs and device types

The IQD (Internal Queued Direct Communication) channel type allows communication between logical partitions on a single CPC and provides high speed, low latency access to data. Support for IQD is available on IBM @server zSeries 900 Driver level 3C with z/OS Communications Server APAR OW49475 installed.

Define the IQD CHPIDs to HCD along with the control units (type IQD) and devices (type IQD) that reside on them. Note that the control units and devices defined to either of these channel paths do not represent real I/O devices but data in a TCP/IP stack.

For an IQD channel path type, the maximum frame size to be used for iQDIO requests on that channel path must be specified. Valid maximum frame sizes supported are 16K (default), 24K, 40K, and 64K. See *z/OS Communications Server: IP Configuration Guide* for further information.

The following configuration rules apply for the IQD CHPID type:

- On a z990 processor, up to 16 IQD CHPIDs can be defined per CPC and may be spanned across all logical channel subsystems and shared among all LPARs needing the function.
- On a pre-z990 processor, up to four IQD CHPIDs can be defined per CPC, to be shared among all LPARs needing the function. IQD CHPID numbers can range from X'00' to X'FF'.
- Up to 16 control units can be defined on each IQD CHPID. If more than one control unit is defined for an IQD channel path, a logical address is required for each control number. Control unit logical addresses can range from X'0' to X'F'.
- Up to 256 devices may be connected to an IQD control unit. The minimum value is 3. HCD has a default of 10 devices per control unit.
- The total number of HSA subchannels for all IQD devices may not exceed:
 - 3072 valid HSA subchannels on a pre-z990 processor.
 - 12,288 valid HSA subchannels on a z990 or later processor.

Specifying an I/O device number

This section describes considerations for specifying a device number when you define an I/O device to your configuration.

A device number is the number you assign to identify a device in HCD. You assign a device number to each device to identify it in the configuration. A device number may be any hexadecimal number from X'0000' to X'FFFF'.

Note: When you specify coupling facility channel path connections, HCD defines control units and devices to attach to the CF sender or peer channel. HCD assigns to each device a device number, which you can override. When assigning the device number, HCD searches to use the highest available number starting with FFFF and continuing in descending order. You might want to avoid assigning the higher range device numbers so they are available for HCD. In general, when operating a sysplex with a coupling facility, avoid higher range device numbers because of the way the system handles ICMF and CF sender or peer channels.

The last two digits of the device number can be the physical unit address of the I/O device. When you define a large number of I/O devices, situations might occur

when it is difficult or undesirable to assign device numbers that contain the physical unit address of the device. When this occurs, you specify the physical unit address in the Unit Address field in the HCD Device / Processor Definition panel when you define a device.

You might want the same device number for two different devices across two partitions or even across processors. The devices have to be attached to different control units. To indicate whether devices identified by the same device number are the same or a different device, you can specify the serial number of the device to HCD.

For ease of tape device management, IBM recommends that you use the same device number on all systems to represent an automatically switchable device. If an automatically switchable device is a 3480 or a 3490 without the 'Read Configuration Data Capable' function, you **must** use the same device number.

Replicating I/O device numbers

When you define more than one device with the same device type, you can have HCD assign the device numbers for these devices. You specify to HCD the device type, the initial device number for the first device, and the number of devices of that type that you want defined. HCD defines the devices in the IODF using consecutive device numbers starting with the initial device number that you specified.

I/O device numbers for multiple exposure devices

The term *multiple exposure device* refers to an I/O device that can be *allocated* by a single device number but can be *accessed* by multiple device numbers from a single MVS system.

For MVS/ESA SP 5.2 or later, multiple exposure devices are no longer supported. If you IPL MVS/ESA SP 5.2 with an IODF containing multiple exposure device definitions, the system does not build unit control blocks for these devices.

I/O device numbers for a parallel access volume

Parallel Access Volume support provides the ability for a single operating system image to drive multiple concurrent I/O requests to a single device. A parallel access volume consists of a logical base device and associated logical alias devices. These logical devices are identified by device numbers and represented by unit control blocks (UCBs) in the system. When you request I/O to a parallel access volume, the request identifies the base UCB and the system uses the base UCB or one of its alias UCBs, depending on their availability, to initiate the request. You use HCD to define multiple device numbers for a control unit that provides parallel access volumes. Base device numbers and alias device numbers are defined independently.

A base device number is used to allocate the device, but other device numbers are needed to represent each alias UCB. The base device number is the one used when any of the following occurs:

- The device is allocated.
- The device is reconfigured with the MVS VARY command.

As shown in Figure 2-8 on page 2-30, when you define a parallel access volume in HCD, you define a control unit type that provides parallel access volume capability, for example '2105'. You define the devices for the control unit with parallel access volume device types. Base devices are defined using a base device type, for

example '3390B' or '3380B'. Alias devices are defined using an alias device type, for example '3390A', or '3380A'. (A 'P' suffix, as in '3390P,' indicates that dynamic alias management is enabled for that device. See "Workload manager and dynamic alias management" on page 2-31 for details.) The device numbers are associated with unit addresses on the control unit using the 'unit address' parameter, which specifies the starting unit address for the set of devices being defined. The number of consecutive device numbers and unit addresses to be assigned is specified with the 'number of devices' parameter.

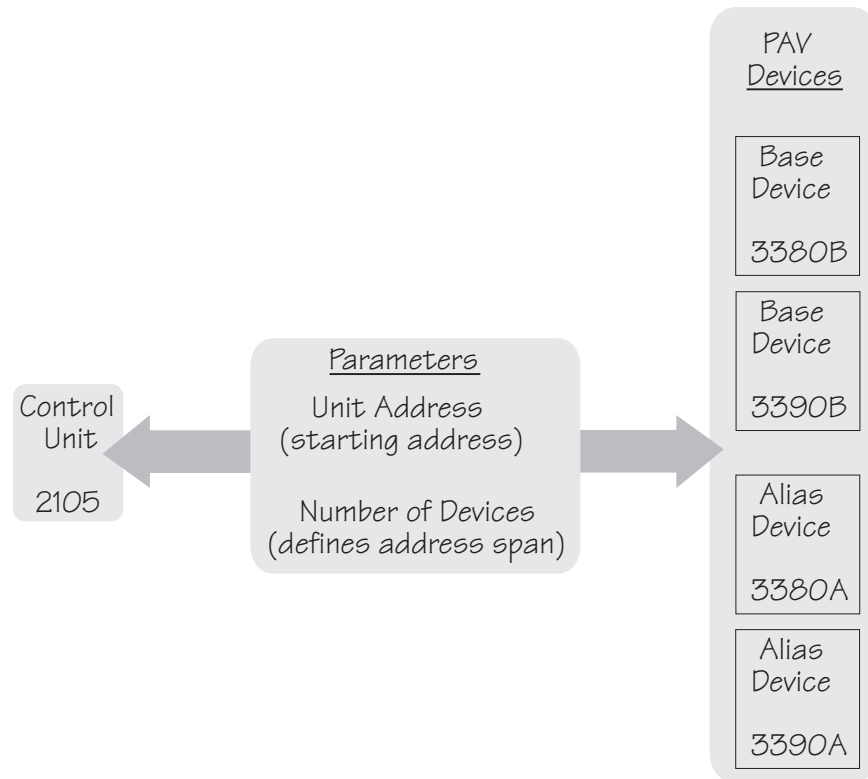

Figure 2-8. Control Unit - PAV Device Relationship

The number of aliases to be assigned to each base device is determined by the parallel access volume's configuration application ("ESS Specialist") at IPL time or at the time a base device is varied online.

HCD provides the capability to specify device numbers for alias devices that are not contiguous with the device numbers for base devices on the same control unit. This capability can be useful in helping you to migrate a string of existing control unit and device definitions to parallel access volume control unit and device definitions. In this situation, you convert the existing device numbers to the base device numbers of the parallel access volume devices. The alias device numbers can then be specified to start with a device number outside the ranges used for any existing devices. For example, you can have one control unit with 64 devices numbered 1A0 through 1DF, and a second control unit with 32 devices numbered 1EO through 1FF. You can change the first control unit to a parallel access volume control unit type that has 64 base devices and 192 alias devices, without disrupting the second control unit.

Table 2-2 on page 2-31 shows the device numbers of the first parallel access volume control unit if you changed the starting alias device number to 21EO. Note

that the device numbers for the second control unit are not shown because they are not disturbed.

Table 2-2. Example of Installation Assignment of Alias Device Numbers

Base 1A0(00)	Alias 21E0(40)	Alias 2220(80)	Alias 2260(C0)
Base 1A1(01)	Alias 21E1(41)	Alias 2221(81)	Alias 2261(C1)
Base 1A2(02)	Alias 21E2(42)	Alias 2222(82)	Alias 2262(C2)
:	:	:	:
Base 1DF(3F)	Alias 221F(7F)	Alias 225F(BF)	Alias 219F(FF)
Values in parentheses are unit numbers on the control unit.			

Another benefit depicted in this example is that you can use four-digit numbers to identify aliases even when the base device numbers are three digits. Because most applications should not need to reference alias UCBs, applications that do not support four-digit device numbers are not affected. If your installation configuration definition lacks available three-digit device numbers and you define four-digit alias device numbers, you can migrate existing devices to parallel access volume devices without using any additional three-digit device numbers.

Workload manager and dynamic alias management

When you define parallel access volume device numbers (as discussed in the previous section), you can also choose to enable or disable dynamic alias management for that device. You do this by specifying **WLMPAV=YES** or **NO** in the HCD definition. YES is the default. When **WLMPAV=YES** is specified, the device number appears with a 'P' suffix, as in, for example, '3390P.'

When dynamic alias management is enabled, workload manager (WLM) monitors the device performance and automatically reassigns alias addresses from one base to another to help work meet its goals and to minimize IOS queueing.

Note, however, that there is no consistency checking for dynamic alias management between different systems in a sysplex. If at least one system in the sysplex specifies **WLMPAV=YES** for a device, then dynamic alias tuning will be enabled on that device for *all* systems in the sysplex, even if other systems have specified **WLMPAV=NO**. It is recommended *not* to use dynamic alias management for a device unless all systems sharing that device have dynamic alias management enabled. Otherwise, WLM will be attempting to manage alias assignments without taking into account the activity from the non-participating systems.

Note, also, that you can specify **WLMPAV=YES** or **NO** on both base and alias devices. The **WLMPAV** setting on an alias device, however, is only meaningful when the alias device is bound to a base device that is offline, as follows:

- If the base device is *offline*, then only alias devices with **WLMPAV** set to YES will be reassigned to other base devices.

The **WLMPAV** setting on the base device itself is irrelevant when the base device is offline, for either “giving” or “receiving” aliases. (Even if **WLMPAV** was set to YES on the base device, it cannot have new aliases assigned to it, as it is offline.)
- If the base device is *online*, then the **WLMPAV** settings on the aliases are ignored, as follows:
 - If **WLMPAV** is set to YES on the base device, then the aliases can be reassigned regardless of their **WLMPAV** settings.

- If WLMPAV is set to NO on the base device, then no aliases can be reassigned, regardless of their WLMPAV settings.

In order for dynamic alias management to be most effective, you should try to spread out your aliases in the initial definition. If one base device has several alias devices while other base devices have none, it will take more time for WLM to reassign the aliases appropriately. Ideally, you should have at least two aliases assigned to each base at the outset.

Dynamic alias management can be globally enabled or disabled for the entire sysplex via the “Service Coefficients/Service Definition Options” panel of the WLM ISPF application. See the “Defining Service Coefficients and Options” chapter of *z/OS MVS Planning: Workload Management* for more information.

Specifying I/O device parameters and features

This section provides information about defining a device to the operating system. You specify parameters and features of a device to the operating system in HCD, such as:

- Whether a device is considered online at IPL
- Whether a direct access storage device (DASD) is shared by other systems
- Whether a device definition can be deleted dynamically
- Whether the UCB for a device is to reside above 16 megabytes
- Whether a device is automatically switchable

HCD displays only the parameters and features that are applicable to the device type.

Defining whether an I/O device will be dynamic

Each I/O device type is represented by a unit information module (UIM), which is included in the product that contains the device support code. The UIM for a device specifies whether or not the device type supports dynamic configuration. If your installation includes device types that support dynamic I/O configuration, you can change your I/O configuration without performing a power-on reset or re-IPLing the system.

Using HCD, you can specify whether a device with device support code that supports dynamic is considered dynamic or not in the operating system definition. Defining a device as dynamic allows you to dynamically add, modify, and delete the device definition while MVS is running.

A device’s support code and definition determine its inclusion in one of the following categories:

- Static
- Installation-static
- Dynamic

Table 2-3 on page 2-33 describes the categories.

Table 2-3. Description of Device Category Capability

Category	Description	Capability	Notes
Static	Device with device support code that does not support dynamic.	<ul style="list-style-type: none"> • Device cannot be dynamically added, deleted or modified in software configuration definition. Therefore the device is not available for use until the next IPL of MVS. • Device can be added, deleted, and modified in the hardware configuration definition, but its channel path information cannot be modified. 	<p>Device types that do not support dynamic configuration include:</p> <ul style="list-style-type: none"> • An IBM device type that MVS does not support. • A device whose device type does not support dynamic configuration. See Appendix A, "Device support for dynamic configuration," on page A-1.
Installation Static	Device support code allows dynamic but is defined as DYNAMIC "No"	<ul style="list-style-type: none"> • Device can be dynamically added to the software definition but cannot be modified or deleted dynamically. • Device can be dynamically added, deleted and modified in the hardware configuration definition, but its channel path information cannot be modified. 	<p>If you must delete or modify installation-static definitions, you can redefine the installation-static device to dynamic. See "Redefining the dynamic parameter for an I/O device" on page 2-34.</p>
Dynamic	Device support code allows dynamic and is defined as DYNAMIC "Yes"	<ul style="list-style-type: none"> • Device definition can be dynamically added, deleted and modified in the software and hardware definition. 	<p>A device definition for a device defined as dynamic can be deleted or modified only if both of the following are true:</p> <ul style="list-style-type: none"> • The device is offline (implies that the device is not allocated). • The device is not pinned. (Pinning is a technique that prevents deleting the unit control block (UCB) and related data structures of a device. See "UCB services considerations" on page 4-19.)

Notes:

1. When you define devices as dynamic make sure that your application programs are using UCB services that support dynamic. See "UCB services considerations" on page 4-19 for more information. You can define devices as installation-static initially until you can update your affected application programs to use UCB services that support dynamic.
2. Installations that IPL with I/O definition files (IODFs) that define dynamic devices should use the IPCS subcommands FINDUCB, LISTUCB, and IOSCHECK to validate and display dynamic UCBs. Any other subcommands might not produce valid results. FINDUCB, LISTUCB, and IOSCHECK are also the subcommands to use for validating and displaying UCBs for devices that have changed from installation-static to dynamic through an ACTIVATE command.
3. Any dynamic change that causes a device's UCB to be deleted and added again, causes the device's MIH time interval to be reset to the default MIH setting for its device class. To reestablish the previous MIH interval, issue the MVS command SETIOS MIH when the dynamic change is completed. For information about this command, see *z/OS MVS System Commands*.

Redefining the dynamic parameter for an I/O device

An installation-static device that is part of an I/O configuration can be redefined from installation-static to dynamic. After you redefine the device from installation-static to dynamic, you can dynamically modify or delete the device from the configuration.

When you change a device from installation-static to dynamic, its unit control block (UCB) address changes. Programs on your system that save UCB addresses will encounter problems if they attempt to use the UCB that was valid when the device was installation-static. To minimize such problems, stop the program before making the dynamic configuration change. When you restart the program after the change, the program scans for and finds the new UCB representing the device.

Note: Redefining a device from installation-static to dynamic does not delete the storage for the original UCB. You must assess the risk of how this may affect your applications and vendor products accessing the UCB.

Modifying or deleting an installation-static device requires two separate dynamic configuration changes:

1. Change the installation-static device to dynamic device (by activating a new IODF that defines the device as dynamic.) No other device characteristics for that device can be changed on the redefinition activation.
2. Delete or modify the dynamic device (by activating another IODF that contains the appropriate changes to the device).

Using the same steps, you can also redefine a device definition from dynamic to installation-static. You can do this if you mistakenly defined a device that was supposed to be installation-static as dynamic.

Note: The UCB for the installation-static device is accessible through the limited UCB services. See *z/OS MVS Programming: Authorized Assembler Services Guide* for information about limited UCB services.

Defining a tape device as automatically switchable

A tape device is **dedicated** when it is capable of being online to only one system at a time. The VARY ONLINE command varies the device online to the issuing system and thereafter no other system can vary the device online until the first system varies it offline. In contrast to dedicated devices, an **automatically switchable** tape device can be online to some or all systems that are participating in tape sharing within the same sysplex.

In addition to HCD, a tape device can be defined as automatically switchable through:

- The VARY AUTOSWITCH command
- The IEEVARYD macro
- The ESCON manager.

Only through HCD does the definition persist beyond the duration of the IPL.

For devices that support automatic tape switching, the AUTOSWITCH parameter appears on the HCD Define Device Parameters / Features panel. Specify a value of either "Yes" or "No" on the AUTOSWITCH device parameter.

You might want to dynamically change the AUTOSWITCH attribute of a device. During peak workload hours, your installation might need additional automatically

switchable devices. Or, after IPL, you might want to add another automatically switchable device. To dynamically change a definition from dedicated to automatically switchable, change the AUTOSWITCH parameter value from "No" to "Yes" and activate the new IODF.

To help you plan the use of your tape devices, see "Using automatic tape switching" on page 2-16.

Defining the location of an I/O device's unit control block (UCB)

To conserve below 16 megabyte common storage, you can define a device's UCB above 16 megabytes. When a UCB is defined above 16 megabytes, programs requiring a 24-bit UCB address can still access the UCB. The system automatically captures the UCB at allocation. A captured UCB provides a 24-bit view into the above 16 megabyte UCB. A captured UCB resides in below 16 megabyte private storage for the duration of a device allocation. The captured UCB is released automatically at deallocation.

For information about accessing above 16 megabyte UCBs, see *z/OS MVS Programming: Authorized Assembler Services Guide*. Before defining an above 16 megabyte UCB, see the migration actions in *z/OS MVS Migration*.

Deciding whether to define above 16 megabyte UCBs

Because captured UCBs use private storage, you must carefully consider whether your installation should define above 16 megabyte UCBs. If you define above 16 megabyte UCBs, be aware that private storage is required for captured UCBs that are created in an address space when data sets are allocated. The system releases the storage when the data set is deallocated.

When you define above 16 megabyte UCBs, captured UCBs are required for certain applications, specifically those applications using data extension block (DEB)-based access methods. You can define above 16 megabyte UCBs for the applications that access them directly and for the applications that do not have private storage constraints when captured UCBs are created.

Capturing a UCB is page-oriented. Even if an address space captures only one UCB into private storage, the whole page of private storage is captured; a subsequent capture of a UCB that resides on the same page will not result in another page being captured to the address space. Other address spaces that need to capture the same UCB will have their own captured UCBs.

An exception to this would be if an address space requests a UCB to be captured to common (for example, through the macro CAPTCOM=YES) and then another address space requests a UCB on the same page to be captured to private. In this case, IOS returns to the second address space the common page address instead of the private page address. This makes sense because it is not necessary to keep multiple copies of the UCBs below 16 megabytes when they are already captured to common.

To determine the extent that you can take advantage of defining above 16 megabyte UCBs, understand whether the following situations apply to your installation. More than one case might apply depending on your installation's applications.

Case 1: The applications can access above 16 megabyte UCBs directly (for example, if you are using VSAM and dynamic allocation with the NOCAPTURE option) and the applications do not require 24-bit addresses for UCBs.

See *z/OS and z/OS.e Planning for Installation* for information about subsystems that support above 16 megabyte UCBs.

Actions:

- Define devices with above 16 megabyte UCBs.
- Use dynamic allocation indicating UCBs are not to be captured.

Predicted Results:

- Constraint on common storage below 16 megabytes is relieved and private storage is not affected.

Case 2: The applications require 24-bit addresses for UCBs (for example, you are using DEB-based access methods) and your common storage is constrained. You can define enough above 16 megabyte UCBs to cause the private storage area to expand into the next megabyte (alleviating private storage constraint).

You can estimate whether you can define enough above 16 megabyte UCBs to cause the private storage area to expand into the next megabyte. At system initialization, the system rounds the amount of common storage to the next megabyte to create a megabyte boundary between below 16 megabyte common and private storage areas. You request common storage with the SQA and CSA parameters. To determine whether the private storage area will expand to the next megabyte, determine the amount of storage used for rounding and subtract it from one megabyte as shown in the following calculation:

1 MB - (actual CSA - requested CSA)

actual CSA - requested CSA

The amount of rounded storage that was allocated to create a megabyte boundary. Determine this amount by subtracting the amount of CSA requested with the CSA parameter in parmlib from the actual amount of CSA present in the system after IPL. You can determine the amount of actual CSA by viewing the RMF™ Monitor III common storage remaining table.

The result of this calculation is the amount of requested CSA as opposed to rounded CSA. If the amount of UCB storage you are moving above 16 megabytes is greater than this value, you have captured enough UCBs to cause the private storage area to expand to the next megabyte. If the amount is less than this value, see cases 3 and 4.

When determining the amount of UCB storage you are moving above 16 megabytes, remember that the size of a UCB is dependent on the device type. For example, a DASD UCB defined below 16 megabytes has approximately 128 bytes below 16 megabytes. The size of the prefix extension is not included because it already exists above 16 megabytes.

Action:

- Define devices with above 16 megabyte UCBs.

Predicted results:

- Constraint on common storage below 16 megabytes is relieved and private storage expanded to the next megabyte so it is not constrained. There is room for the captured UCBs that the applications need.

Case 3: Some of your applications require 24-bit addresses for UCBs and your common storage is constrained. You cannot define enough above 16 megabyte

UCBs to cause the private storage area to expand into the next megabyte and private storage is not currently constrained. Other applications in your installation might have enough room for the captured UCBs that they require or might not require captured UCBs.

Action:

- Be cautious about defining any above 16 megabyte UCBs. Capturing UCBs might cause your private storage to become constrained. There must be enough room in your private storage for captured UCBs for the application.

Predicted results:

- Some constraint on common storage below 16 megabytes is relieved.
- If you limited the number of above 16 megabyte UCBs, your private storage is not constrained. You might choose to move the UCBs for certain applications because there is room for the captured UCBs that they require. When trying to make this decision, remember that the same UCBs might be accessed by more than one application.

Case 4: Some of your applications require 24-bit addresses for UCBs and your common storage is constrained. You cannot define enough above 16 megabyte UCBs to cause the private storage area to expand into the next megabyte and private storage is constrained.

Action:

1. Try to relieve private storage constraint by moving as much data as possible to above 16 megabyte private storage.

For example, the BSAM, QSAM, BPAM, and BDAM access methods allow data areas to be located above 16 megabytes. This support includes allowing the caller to issue most SAM, PAM, and BDAM macros in 31-bit addressing mode regardless of whether the data is above or below 16 megabytes. See *z/OS DFSMS Macro Instructions for Data Sets* for more information.

Also, if you are using VSAM to allocate devices, you can use the NOCAPTURE option when you dynamically allocate devices so UCBs are not captured.

2. Try to have private storage expand to the next megabyte by changing the CSA and SQA initialization parameters.

The system rounds the amount of common storage to the next megabyte to create a megabyte boundary between the below 16 megabyte common and private storage areas. You request common storage with the SQA and CSA parameters in the IEASYSxx parmlib member.

Determine the amount to reduce the CSA/SQA parameter values to force private storage to the next megabyte using the following calculation:

$$(1\text{MB} - (\text{actual CSA} - \text{requested CSA})) - \text{storage savings}$$

actual CSA - requested CSA

The amount of rounded storage that was allocated to create a megabyte boundary. Determine this amount by subtracting the amount of CSA requested with the CSA parameter in parmlib from the actual amount of CSA present in the system after IPL. You can determine the amount of actual CSA by viewing the RMF Monitor III common storage remaining table.

storage savings

The amount of common storage saved by moving UCBs above 16 megabytes. If you have already moved the UCBs, you can look at the actual storage numbers before and after moving UCBs to determine the

savings or you might choose to estimate the amount you will save and then make any changes as necessary. The size of a UCB is dependent on the device type. For example, a DASD UCB defined below 16 megabytes has approximately 128 bytes below 16 megabytes. The size of the prefix extension is not included because it already exists above 16 megabytes.

Remember that you need to reserve SQA/CSA storage for the current workload as well as for future expansion. Make sure that you include that estimate when you request common storage below 16 megabytes with the CSA and SQA parameters. For more information about the parameters, see *z/OS MVS Initialization and Tuning Reference*.

3. Continue to define below 16 megabyte UCBs. Do not define any above 16 megabyte UCBs.

Predicted results:

One of the following:

1. You were able to reduce private storage constraints enough to capture the UCBs as necessary for the application.
2. You were able to tune the CSA and SQA parameters to expand to the next megabyte.
3. You decided not to define above 16 megabyte UCBs for this application.

Case 5: You are adding new devices to your installation, for example, a string of 3390 devices, and you are concerned about below 16 megabyte common and private storage constraints.

Action:

- Define as many UCBs above 16 megabytes as possible to prevent below 16 megabyte common or private storage from becoming constrained.

Define enough above 16 megabyte UCBs to prevent below 16 megabyte common storage from expanding into the next megabyte segment when the IODF with the additional device definitions is used at the next IPL. For example, if only a small amount of below 16 megabyte common storage is used to round CSA to the next megabyte boundary, additional UCBs might cause common storage to expand into the next megabyte. This situation could be a problem if your private storage is constrained because of the expansion of common storage into what otherwise would be private storage. Prevent this problem by defining above 16 megabyte UCBs; however, be aware that some private storage might be used for captured UCBs depending on your applications.

Predicted results:

- Constraint on common below 16 megabyte storage is not adversely affected by the addition of the new devices.

Defining an above 16 megabyte UCB

You can use HCD to define a device's UCB above 16 megabytes if the device's unit information module (UIM) indicates that the device support code enables above 16 megabyte UCBs. If the device support code supports above 16 megabyte UCBs, the LOCANY parameter appears on the HCD Define Device Parameters / Features panel. Specify a value for the LOCANY device parameter to either:

- Define a device's UCB below 16 megabytes only (LOCANY is No). The UCB cannot reside in 31-bit storage.

- Define a device's UCB above 16 megabytes (LOCANY is Yes). The UCB can reside in 31-bit storage.

The default for LOCANY (if it is not specified by the UIM) is No. This can be overwritten by including the option OS-PARM-DEFAULT = LOCANY,YES in the HCD profile.

You can dynamically change the definition of a UCB. To dynamically change a definition from below 16 megabytes to above 16 megabytes, change the LOCANY parameter value from "No" to "Yes" and activate the new IODF.

Defining allocation preferences

This section gives background information about I/O device allocation, which you need to understand before defining the EDT and esoteric device groups in your configuration.

You can control the allocation preferences for I/O devices using HCD. First, you must understand how devices are allocated for jobs in MVS.

Understanding I/O device allocation in MVS

When you submit a job, you identify I/O devices required by the job. The device information can be obtained from either a catalog, SMS overrides, or specific UNIT parameters on DD statements. Before the job can continue execution, MVS must allocate all those devices to the job.

There are three ways to specify device allocation for a job using UNIT parameters on DD statements. On the UNIT= parameter, specify one of the following:

- A specific device number
- A generic device type
- An esoteric device group

Indicating a specific device for allocation

To request a device explicitly for a job, specify a device number on the UNIT= parameter or on the corresponding dynamic allocation parameter. If that device is available, MVS allocates the device to the job. However, if the device is unavailable (for example, allocated to another job), your job must wait until the device is available for allocation.

Specifying a generic device type for allocation

MVS logically groups device types with similar characteristics and assigns the group a generic name. Such a group is called a generic device type. MVS, for example, groups the 3330-1, 3330-2, and 3333-1 into a generic device type named 3330. Any time a program allocates a 3330, MVS interprets it to mean any of the devices in that generic device type.

To request a device allocation, you can specify a generic device type on the UNIT= parameter. MVS allocates a device from the specified generic device type. For example, if you code the following DD statement:

```
//OUTPUT DD UNIT=3330,...
```

MVS allocates a device from generic device type 3330.

If you specify a device number, such as 3330, that may be mistaken for a unit device type, precede the device number with a slash.

For example, if you code the following DD statement:

```
//OUTPUT DD UNIT=/3330,...
```

MVS allocates the device that has the device number 3330.

Note: An esoteric device name must not contain a slash (/).

See the UNIT= parameter description in *z/OS MVS JCL Reference* for a more detailed explanation.

Specifying an esoteric device group for allocation

A job that specifies an *esoteric device group* is requesting MVS to allocate a device from that group. An esoteric device group can include devices of different generic device types. All of the devices that you assign to an esoteric device group must be of the same device class with the following exception: you can define esoteric device groups that contain devices from both DASD and tape device classes.

Devices belong to one of the following classes:

- Channel-to-channel adapters
- Communication devices
- Direct access devices
- Display devices
- Character readers
- Tape devices
- Unit record devices

To request device allocation, you can specify an esoteric device group on the UNIT= parameter. For instance, DASD and TAPE are group names that identify a group of devices eligible for allocation to satisfy a UNIT=group request (for example, UNIT=DASD, or UNIT=TAPE on the DD JCL statement).

MVS uses the eligible device table (EDT) to determine the set of devices associated with the esoteric device group. Figure 2-9 gives an example of relationships among generic and esoteric device groups.

Generic Device Types	3800	3490	3380				3390					
Esoteric Group Name	(1)	TAPE(2)		SYSDA (3)								
				DA1 (4)				DA2(5)				
Device Number	131	151	152	181	182	183	184	190	191	192	193	194

Figure 2-9. Relationships among Generic and Esoteric Device Groups

Notes:

1. The absence of an esoteric group name means that you can request the 3800 as UNIT=3800, or specify the specific device number, 131.
2. TAPE is the esoteric group name for the two 3490 tape drives, with device numbers 151 and 152.
3. SYSDA is the esoteric group name for two 3380s (device numbers 183 and 184) and five 3390s (device numbers 190-194). When UNIT=SYSDA appears on a DD statement, units 183, 184, 190, 191, 192, 193, and 194 are eligible devices.
4. DA1 is the esoteric group name for two 3390 DASDs (device numbers 191 and 192).
5. DA2 is the esoteric group name for a single 3390 DASD (device number 193). When DA2 is coded on a DD UNIT parameter, device number 193 is the only device eligible for that allocation request.

When MVS allocates a tape device to a job, it serializes access to the specified esoteric device group until the allocation request is satisfied. Only the devices that belong to the specified esoteric device group are unavailable for allocation to other jobs. When the tape device is automatically switchable, all other automatically switchable devices of that generic device type are unavailable for allocation to other jobs during device selection. Referring to Figure 2-9 on page 2-40, assume that TAPE151 is device 151 and TAPE152 is device 152 and that both devices are automatically switchable. If one jobstep requests UNIT=TAPE151 and during the selection process another jobstep requests UNIT=TAPE152, the system does not consider TAPE152 to be eligible for the second jobstep. This action occurs because both TAPE151 and TAPE152 are generic type 3490 and are automatically switchable.

Required esoteric device groups: A number of procedures in the IBM-provided SYS1.PROCLIB refer to the esoteric names SYSDA or SYSSQ. If your installation uses these procedures, you must define these esoteric device groups to HCD.

The group named SYSSQ must include only tape devices, only direct access devices, or both. The group named SYSDA must include only direct access devices.

In addition, your installation might use other cataloged procedures that also refer to these or to other esoteric names. To determine which esoteric groups your installation uses, check the UNIT= parameter on the cataloged procedure DD statements.

Specifying order in an esoteric with the device preference table

An esoteric device group can include devices of more than one generic device type. When MVS attempts to allocate a demountable device, a unit record, or a printer from an esoteric device group, it turns to the device preference table that defines the order in which to attempt the allocation. The system uses the table to serialize its selection of those devices.

HCD provides a predefined device preference table that defines the generic device types and lists them in order of performance. (The first device type on the list is the fastest. The last device type on the list is the slowest.) You can use the default device preference table values for a generic or you can specify a different value to change the allocation order.

See Appendix B, “Summary of device information,” on page B-1 for a list of generic device types and their pre-defined preference values.

For tape requests, the system considers many factors: the type of request, the devices eligible to satisfy the request, and the characteristics of each eligible device. Based on these factors, the system selects the optimal device to allocate. MVS allows users to participate in the selection process through the use of SSI function code 78. For details on how to use function code 78, see *z/OS MVS Using the Subsystem Interface*.

Advantages of specifying an esoteric device group

By requesting a specific device (for example, UNIT=570), you limit MVS to a choice of only one device, thereby decreasing the probability that the device will be available when the job needs it. In contrast, by requesting a generic device type, you can allow MVS a choice of several devices, thereby increasing the probability that a device will be available when the job needs it. Of course, this increase in probability assumes that there will be more than one device of that generic type available for allocation.

When you request a generic device type, MVS serializes access to that generic device type. This means that MVS does not allocate devices from that generic device type to other jobs until MVS satisfies your jobstep allocation request. Because MVS makes the entire generic device type unavailable for allocation to other jobs, there might be a delay in satisfying other jobs' allocation requests. Therefore, requesting a generic device type increases the probability that there will be a delay in satisfying allocation requests for other jobs. However, waiting for a generic device type generally takes much less time than waiting for a specific device.

Assuming that the esoteric device group identifies more than one device, a device will more likely be available for a UNIT=TAPE request, for example, than if the request was for a specific device. Also, if you assume that the esoteric device group does not contain all of the devices from any one generic device type, devices from each generic device type might still be available for allocation to other jobs while MVS serializes access to the esoteric device group.

To summarize how the system handles the different UNIT specifications, here are three examples. The first two examples describes dedicated devices and the third describes automatically switchable devices.

The first example compares the likelihood of the system being able to satisfy the following specific and generic device requests:

- UNIT=270
- UNIT=3480, where the devices are defined at addresses 270, 273, 285, 294, 366, and 414.

In this case, it is more likely the request can be satisfied by any of the six devices eligible with the UNIT=3480 request than with the UNIT=270 request.

The second example shows how you can subdivide devices into two esoteric specifications so that two jobs can have similar device requests satisfied at the same time. The devices are defined as follows:

- TAPE1 is 270, 273, and 285
- TAPE2 is 294, 366, and 414.

In this case, jobs that request TAPE1 can be in allocation at the same time as jobs that request TAPE2.

The third example is the same as the second example and the UNIT specifications are the same; however, all devices are automatically switchable. In this case, jobs that request TAPE1 and jobs that request TAPE2 cannot be in allocation at the same time. The second job will have to wait for the first job to complete allocation. This will be true whether the jobs are on the same system or on different systems.

Holding or releasing resources while a job waits

Assuming that you are not using JES3 pre-execution setup, to make best use of device allocation, you must decide whether the system should hold or release resources (non-sharable devices and volumes) while a job waits for those resources. When the operator requests that allocation for a specific job is to wait for resources, the system issues a message that asks the operator to reply with either HOLD or NOHOLD.

HOLD The system holds non-sharable devices and volumes already allocated to the job. Select this option if the needed resources are constantly being freed, and allocation requests for other jobs will probably not be held up by the requests made for this job. This job can hold up other requests in either of two ways:

1. The job has already allocated units needed for another job.
2. The job is waiting for devices to which MVS is controlling access through serialization.

NOHOLD

The system releases non-sharable devices and volumes already allocated to the job. Select this option if the needed resources may not be freed for some time, and allocation requests for this job are likely to hold up allocation requests issued for other jobs.

Note: Requests for dynamic allocation are not held up by requests waiting for batch allocation, even though the jobs awaiting batch allocation are holding resources.

A dynamic change can be held up from completing if allocation is waiting for a response. For information about automating responses to allocation messages, see *z/OS MVS Installation Exits*.

Device preference table's effect on UNIT=AFF request: When a job requests unit affinity, the order of devices in the device preference table can affect allocation. (See Figure 2-10 on page 2-44.) The lower a device's preference value, the higher its priority. Device preference values affect allocation whenever a DD requests unit affinity to another DD that has requested allocation to an esoteric device group and both DDs specify a status of NEW. When this situation occurs, MVS allocates both DDs to the same physical unit. That unit:

- Will belong to the specified esoteric device group
- Will have the lowest device preference value from that esoteric device group to appear in the device preference table

Conditions

- Your installation has previously defined an esoteric device group and named it TAPE. Device types 3400-3, 3400-5, and 3480 belong to the group named TAPE.
- Your installation is using the IBM-provided device preference table. In that table affected device types appear with the following device preference values:

Types Values

3480 1100

3400-5
1200

3400-3
1210

- Assume the following JCL statements:

```
//JOB1 JOB .....  
//STEP1 EXEC .....  
//DD1 DD DISP=NEW,UNIT=TAPE,.....  
//DD2 DD DISP=NEW,UNIT=AFF=DD1,.....  
.  
.  
//
```

Explanation

- DD1 requests MVS to allocate a device from the esoteric device group TAPE.
- DD2 requests affinity to DD1.
- MVS allocates DD1 and DD2 to the same physical unit. That unit will be a 3480.

Figure 2-10. Example of Device Preference Table Affecting UNIT=AFF

Device preference values also affect the unit-affinity-ignored unit name, that is, the UNITAFF parameter in the ALLOCxx parmlib member. If the installation does not specify UNITAFF, the system default is the tape generic highest in the device preference table. For more information, see the ALLOCxx UNITAFF parameter in *z/OS MVS Initialization and Tuning Reference*.

See Figure 2-11 on page 2-45 for an example.

Assumptions

- UNITAFF was not specified in ALLOCxx
- The SMS ACS routines are defined so that:
 - Data set L is to be redirected from tape to an SMS-managed DASD volume, SD3
 - Data set M is not to be redirected and is, therefore, still intended to go to a non-SMS-managed tape volume
- Your installation is using the IBM-provided device preference table. In that table the affected device types appear with the following device preference values:

Types Values

3490 1000

3480 1100

- Assume the following JCL statements:

```
//JOB2 JOB .....
//STEP1 EXEC .....
//DD11 DD DSN=L,DISP=(NEW),UNIT=3480,.....
//STEP2 EXEC .....
//DD21 DD DSN=L,DISP=OLD,.....
//DD22 DD DSN=M,DISP=(NEW,CATLG),UNIT=AFF=DD21
```

Explanation

- In STEP1, DD11, data set L is created and cataloged on SD3, SMS-managed DASD (redirected using SMS ACS routines).
- In STEP2, DD21, data set L is an existing data set, cataloged on SD3, SMS-managed DASD. DD21 is both the referenced DD (referenced by the UNIT=AFF on DD22) and the primary DD.
- In STEP2, DD22 is the referencing DD, which requests unit affinity to DD21. Because data set L is on SMS-managed DASD, the system cannot honor the unit affinity for DD22, which is intended to go to tape. With the unit affinity ignored, the system must determine a unit to be used for DD2. Because UNITAFF was not specified in ALLOCxx, UNITAFF will default to 3490 because it is the tape generic highest in the device preference table. DD22 will be allocated to a 3490.

Figure 2-11. Example of Device Preference Table Affecting the Default Unit-Affinity-Ignored Unit Name

Note: In a JES3 environment, the IBM-supplied device preference table defines 3480X devices with a higher priority than 3480 devices. Do not alter this priority, because, if you do, the system does not honor a request for affinity between the two device types. A job that requests data set affinity between 3480X and 3480 devices will fail when the installation has specified a higher preference for the 3480 devices.

Defining device allocation in HCD

You use HCD to define esoteric device groups and specify the device preference values of generics within esoteric device groups. You do this by defining eligible device table (EDT) information using HCD.

Information about device allocation is collected in an EDT for MVS. An EDT is an installation-defined and named representation of the devices that are eligible for allocation. The EDT also defines the esoteric and generic relationships of these devices.

During each IPL, or during a dynamic configuration change, your installation identifies the EDT that MVS is to use. During an IPL, you identify the EDT in the

LOADxx member. See Chapter 3, “Specifying an I/O configuration at IPL,” on page 3-1 for a description of the LOADxx member. During a dynamic configuration change, you identify the EDT on the HCD Activate New Configuration panel or on the ACTIVATE command. Jobs that run after the IPL or dynamic change can request device allocations from any of the esoteric device groups assigned to the selected EDT.

Your installation can define multiple EDTs in each I/O definition file (IODF). For each I/O configuration, you can define:

- One EDT with no changes to the device preference table
- One EDT with changes to the device preference table
- Multiple EDTs with or without changes to the device preference tables

You define each EDT with a unique identifier in HCD.

Note: In a JES3 environment, JES3 supports only one EDT per I/O configuration. If a JES3 installation defines more than one EDT in a configuration, JES3 will support only the first EDT defined.

Each EDT definition can include:

- Definitions for one or more esoteric device groups (See “Defining esoteric device groups in an EDT using HCD.”)
- Changes to the device preference table (See “Changing the device preference table order.”)
- Names of the generic device types you want to make eligible for VIO (See “Defining devices as virtual I/O (VIO) eligible” on page 2-47.)

You can use HCD to view the configuration data in an EDT. Programs can view information from the currently active EDT using the EDTINFO macro. (See *z/OS MVS Programming: Assembler Services Reference ABE-HSP*.)

Defining esoteric device groups in an EDT using HCD

Use HCD to define an esoteric group, assign the group a name, and identify the I/O devices that you want included in the group. The name you assign to an esoteric device group is called the esoteric name. To request allocation of a device from an esoteric device group, specify the esoteric name on the UNIT= parameter of a JCL DD statement.

Note: In JCL terminology, an esoteric name is called a group name.

Within a given EDT, no two esoteric device groups can have the same name. An esoteric device group in one EDT, however, can have the same name as an esoteric device group in another EDT.

Note: Do not use esoteric names **SYSALLDA**, **SYS3480R**, or **SYS348XR**, which are reserved for use by IBM.

Changing the device preference table order

The device preference table defines the order of devices that MVS uses to satisfy an allocation request. To change the device order that MVS is to use when attempting to satisfy an allocation request, use HCD to define a new preference table order as part of a new EDT definition in the IODF. In the device preference table, devices with lower preference values have higher priority. If the allocation is unsuccessful, MVS continues the attempt following the order specified in the IBM-provided device preference table.

When you define a device, HCD automatically defines the generic device type in the EDT. You can use HCD to view the generics defined in an EDT. For each generic in an EDT, you can specify an installation device preference table value to specify the order the generic is allocated within an esoteric or you can keep the IBM default device preference value.

Defining devices as virtual I/O (VIO) eligible

VIO refers to data set allocations that exist in paging storage only. MVS does not use a real device unless MVS must page out the data set. If MVS must page out the data set, MVS writes it to a paging device. Programs that use VIO data sets access them just as if the data sets were allocated to a real I/O device.

You can allocate only temporary data sets to VIO. To request a VIO allocation, the UNIT= parameter on your DD statement must specify an esoteric device group or generic device type that is eligible for VIO. *z/OS MVS JCL Reference* and *z/OS MVS JCL User's Guide* explain, in detail, how to make the request. Those books also explain the conditions that must be met before MVS satisfies a VIO allocation request.

You use HCD to identify the esoteric device groups or the generic device types that you want to be eligible for VIO allocation. MVS will allocate only DASD for VIO. Therefore, any group that you identify must contain at least one DASD.

You can identify one or more *direct access* generic device types that you want to make eligible for VIO.

EDTs for dynamic configuration

Some dynamic configuration changes that you can make to an EDT are:

- Changes to esoteric groups
- Changes to the device preference table values for generics, which determines the order in which devices are allocated from an esoteric group

These dynamic configuration changes could be used to define an IODF with the same hardware configuration but with a different ID for the EDT. The different ID for the EDT allows an installation to activate a configuration with a different device preference order and different esoteric device groups for different jobs, such as off-shift work. Other dynamic configuration changes that affect the EDT are:

- Adding devices, including appropriate new generic names
- Deleting devices
- Modifying devices, which results in deleting then adding the same device numbers (Message IOS502I reports the deleted and added device.)

A dynamic configuration change causes MVS to activate a new EDT definition.

Primary and secondary EDTs: Usually, MVS uses one eligible device table (EDT) to process allocation requests. However, when you dynamically change your system's software I/O configuration definition, MVS must use two EDTs to process the change:

- The **primary EDT** processes all current and new allocation requests. MVS runs with only the primary EDT until you make a dynamic configuration change. MVS then activates a new primary EDT for the new I/O configuration, which makes the old primary EDT the secondary EDT.
- The **secondary EDT** receives no new allocation requests. The system deletes the secondary EDT when it finishes the allocation requests issued before the dynamic configuration change.

A second activation may fail if the previous activation is not finished because work is still accessing the secondary EDT.

Chapter 3. Specifying an I/O configuration at IPL

You need to specify your configuration definition at IPL during initial install, upgrade, and recovery. Any other time that you need to make a configuration change, you can make the change dynamically without an IPL or POR if you are using the dynamic capability of HCD.

Defining your initial I/O configuration

You define your initial I/O configuration in the following situations:

- You could be installing MVS for the first time. In which case, you would have a bootstrap system, consisting of an install IOCP (stand-alone IOCP) and a bootstrap MVS. This would require an initial "bootstrap" POR and probably IPL.
- You could be using IODFs for the first time and want to use dynamic configuration capability. In this case, you could run HCD and create the IODF. Do a POR to get the active IOCDS token in the HSA. See "Ensuring that the software and hardware definitions match" on page 1-6 for information about configuration tokens.

Each time you install a new processor that does not have an IOCDS yet, you can use HCD to build an IOCP input data set. Then you can transfer this data set to tape and run the IOCP stand alone program that is installed in your processor.

Take the following general actions to define your configuration at IPL:

1. Create I/O software configuration plan.
See Chapter 2, "Planning your I/O configuration definition," on page 2-1
2. Install your I/O devices.
See device guides for information about devices.
3. Install z/OS, which includes HCD.
See *z/OS Program Directory* and *z/OS HCD User's Guide*.
4. Install software support for IBM equipment.
The UIM points to other device support information provided with the product. See program directories for IBM products such as Data Facility Storage Management Subsystem/MVS (DFSMS/MVS[®]) or Virtual Telecommunications Access Method (VTAM[®]).
5. Provide and/or install software support for devices not supported by MVS.
See *z/OS MVS Device Validation Support*.
6. Determine whether to authorize access to making dynamic configuration changes. The security administrator can use RACF to authorize operators and HCD users to activate dynamic changes. Before anyone can use either the ACTIVATE command or the HCD Activate New Configuration panel, the security administrator must give that user UPDATE authority to the MVS.ACTIVATE resource in the OPERCMDS class. (See *z/OS MVS Planning: Operations*.)

Note: Without RACF 1.9 or the equivalent security product, you cannot use the HCD panels for activation, use the MVS ACTIVATE command.

7. To handle data sets that are cataloged with an esoteric name, do one of the following:
 - Specify a token for the esoterics. Allocation uses the esoteric token to find the appropriate esoteric for a data set that has been cataloged using

esoterics. You no longer have to keep the esoterics in the same sequence and can delete and add esoterics without having problems accessing data sets that are cataloged using esoterics.

- Recatalog the data sets with a generic device type name (for example, 3380) before using HCD to migrate IOCP/MVSCP data.

8. Invoke HCD.

You start HCD like any other ISPF application in your TSO/E system. The default TSO/E CLIST that is supplied with HCD is CBDCHCD (which invokes CBDCHCD1) in library SYS1.SCBDCLST.

See *z/OS HCD User's Guide* for more information, including which functions are available as batch utilities and thus do not require ISPF.

9. Use HCD to define your configuration:

- a. Create a work IODF by either migrating MVSCP/IOCP decks with the HCD panels or migration batch facility or updating an existing IODF.

Note: If you are **not** using dynamic capability, sometimes you can anticipate I/O configuration changes. For example, you might know that a control unit and associated DASDs will be installed but are not installed when MVS is IPLed. Two possible methods of adding the control unit and the DASD are:

- Define the control unit and DASD to both the hardware and the software before devices are installed. This strategy saves a POR and IPL when the physical control unit and DASD are installed. However, the inactive UCBs waste storage until devices are installed.
- Define the control unit and DASD only to the hardware before devices are installed. During POR, hardware definitions of the devices are built. When the control unit and DASD are installed, create the software definition, then IPL MVS with the new software definition to make the devices available. This strategy saves a POR.

- b. Create a production IODF from the work IODF.

See *z/OS HCD User's Guide* for information about creating IODFs.

You do not need to pre-allocate an IODF; you allocate it through HCD, and it resides on the volume you specify through HCD.

You specify an EDT identifier and create an EDT as part of defining your configuration in HCD. You also specify an operating system configuration identifier.

10. Create the LOADxx member in which you specify an IODF statement to identify the I/O configuration definition for IPL.

An IODF statement contains the name of the production IODF and identifier of the EDT and operating system configuration that is used to IPL the system. The IODF identified becomes the active IODF for the system.

The Load Parameter Definition (8 byte field) on the SYSCTL or OPRCTL frame on ES/9000 processors tells which LOADxx member to use.

See "IODF processing at IPL" on page 3-5 for more information.

11. Specify the configuration to the hardware.

Use HCD to run IOCP to create I/O configuration data sets (IOCDSSs). To create IOCDSSs, you can also use IOCP directly without using HCD, but then dynamic capability will not be available. See *IOCP User's Guide*.

- |
- | 12. Unless you are running on an z990, at POR, specify the HSA and MIF
- | expansion requirements for any future dynamic changes. To enable dynamic
- | I/O configuration changes, you must also indicate that you want to allow
- | dynamic modifications. You specify this information in the Activation Reset
- | profiles.

|

| If you expect to make dynamic configuration changes, you must specify a

| percent of expansion for the size of HSA. (See *Enterprise System/9000*

| *Operator Guide* .) You indicate the percent increase of existing HSA size. A

| 10% expansion factor will allow 10% more devices and control units. For

| example, when you have ten devices and want to add 2 devices, you specify

| 20 percent expansion.

|

| The amount of HSA storage that the channel subsystem requires depends on:

- | • The configuration definition (the number of devices, control units, and
- | channel paths defined in the IOCDS) used for the POR
- | • The processor model and microcode level

|

| There is an HSA option on the DISPLAY IOS,CONFIG command that displays

| the amount of HSA remaining for dynamic changes. See *z/OS MVS System*

| *Commands* for a description.

|

| You can only increase the HSA expansion percentage by performing another

| POR.

|

| Unless you are running on a z990, you also need to specify the expansion

| factor for MIF. For IBM processors other than z990, you indicate the

| percentage of the expansion that is for shared devices. For example, if you

| specify 50 percent, half the expanded HSA will be used for additional shared

| devices and the other half for additional unshared devices. If you specify 100

| percent, all the expanded HSA will be used for additional shared devices. See

| the processor manuals for more information.

|

| On a z990, you do not specify HSA and MIF expansion percentages. Instead,

| specify the maximum number of devices that you will want to access. When

| you define each logical channel subsystem, this value replaces the HSA and

| MIF expansion requirements. This number should take into account any

| changes you may want to make in the future. You can specify up to 63K

| devices.

- |
- | 13. Do a POR to initialize the channel subsystem/HSA from an IOCDS created by
- | HCD.

|

| When you go to make changes to your configuration, tokens in the current

| IODF and HSA must match in order to make hardware changes. To get the

| matching token in the HSA, you have to perform a POR with an IOCDS

| created by HCD. The IOCDS must contain a hardware configuration definition

| included with the current IODF.

- |
- | 14. When specifying system parameters for IPL, use the SQA parameter in the
- | IEASYSxx member of SYS1.PARMLIB to define estimated additional storage
- | for UCBs that will be added by future dynamic changes. System parameters
- | can be specified either in the IEASYSxx member of SYS1.PARMLIB or as
- | operator responses to IPL messages.

|

| At IPL the system determines from the current I/O configuration how much

| SQA and ESQA to use to represent the UCBs for the I/O configuration being

| IPLed. This amount of SQA and ESQA storage is then increased by the

| amount that you request on the SQA parameter in the IEASYSxx member of

| SYS1.PARMLIB. (See *z/OS MVS Initialization and Tuning Reference*.)

You must ensure that there is also enough system queue area (SQA) storage for any devices that are to be dynamically added to a configuration. A UCB on average needs 112 bytes of storage below 16 megabytes and 88 bytes above 16 megabytes.

When you dynamically add UCBs, the system obtains storage for these new UCBs from the SQA allotment. For example, if you add 10 devices to your configuration, the system obtains about 1120 bytes of SQA and 880 bytes of extended system queue (ESQA) for the new UCBs.

Note: If your installation needs to dynamically change between different configurations, in which few or none of the devices are the same, your installation must ensure there is enough SQA for the largest configuration and for the next largest configuration to be used. MVS needs enough storage for all the UCBs in the current configuration and all the new and changed UCBs in the replacement configuration. If there is a problem during activation of the replacement configuration, MVS needs this storage to recover and reestablish the UCBs that existed before the attempt to change the configuration.

15. When specifying system parameters for IPL, use the CMB parameter to define estimated additional storage for channel measurement blocks (CMBs) that will be added by future dynamic changes. System parameters can be specified either in the IEASYSxx member of SYS1.PARMLIB or as operator responses to IPL messages.

A channel measurement block accumulates measurement data for I/O devices. You need to specify, on the CMB parameter in the IEASYSxx member of SYS1.PARMLIB, the sum of the number of I/O devices that you need to measure that are not DASD or tape (or other types of devices specified using the CMB options) plus the number of devices that you plan to dynamically add and measure. (See *z/OS MVS Initialization and Tuning Reference*.)

To determine the number of devices that the system can measure during a given IPL, the system calculates the sum of the following:

- The number of DASD devices in the I/O configuration definition that you selected at IPL
- The number of tape devices in the I/O configuration definition that you selected at IPL
- The value that you specified on the CMB parameter

Therefore, when you define the CMB parameter, remember that the system allocates CMB space for the DASD and tape devices contained in the I/O configuration definition that you select at IPL.

If you have z990 exploitation support installed on your system, the system ignores the CMB (channel measurement blocks) parameter in the IEASYSxx parmlib member. z/OS dynamically allocates enough space to accommodate the number of devices in use, up to the maximum number of devices possible.

16. Initialize MVS/ESA with the production IODF and select the appropriate LOADxx member for the configuration. See "IODF processing at IPL" on page 3-5 for more information.

IODF processing at IPL

When you perform an IPL, the production IODF that defines the configuration to the system is selected and used. This IODF is selected from any number of other IODFs. You identify the IODF by the IODF statement in the LOADxx member of SYSn.IPLPARM or SYS1.PARMLIB PDS.

To identify the IODF selected at IPL, do the following:

1. Identify the IODF volume. An IODF volume is the direct access storage device (DASD) on which you place your IODFs. You identify the IODF volume on the LOAD parameter on the operator control (OPRCTL) or system control (SYSCTL) frame that is used when the system software is loaded or in the LOAD profiles for a 9672 Parallel Transaction Server. See the processor documentation for more information.

On the LOAD parameter, you specify the device number of the IODF volume and the identifier for the LOADxx member. If you do not specify an IODF volume on the LOAD parameter, the system searches the sysres volume. If you do not specify a LOADxx member on the LOAD parameter, the system uses LOAD00.

The SYSn.IPLPARM or SYS1.PARMLIB PDS contains the LOADxx member. See “Search order for the LOADxx member and IODF” on page 3-7 for a description of the order in which the PDSs are searched.

2. In the LOADxx member, include an IODF statement that identifies the production IODF for IPL. For details about LOADxx, see *z/OS MVS Initialization and Tuning Reference*.

Figure 3-1 on page 3-6 shows how the IODF is identified for IPL.

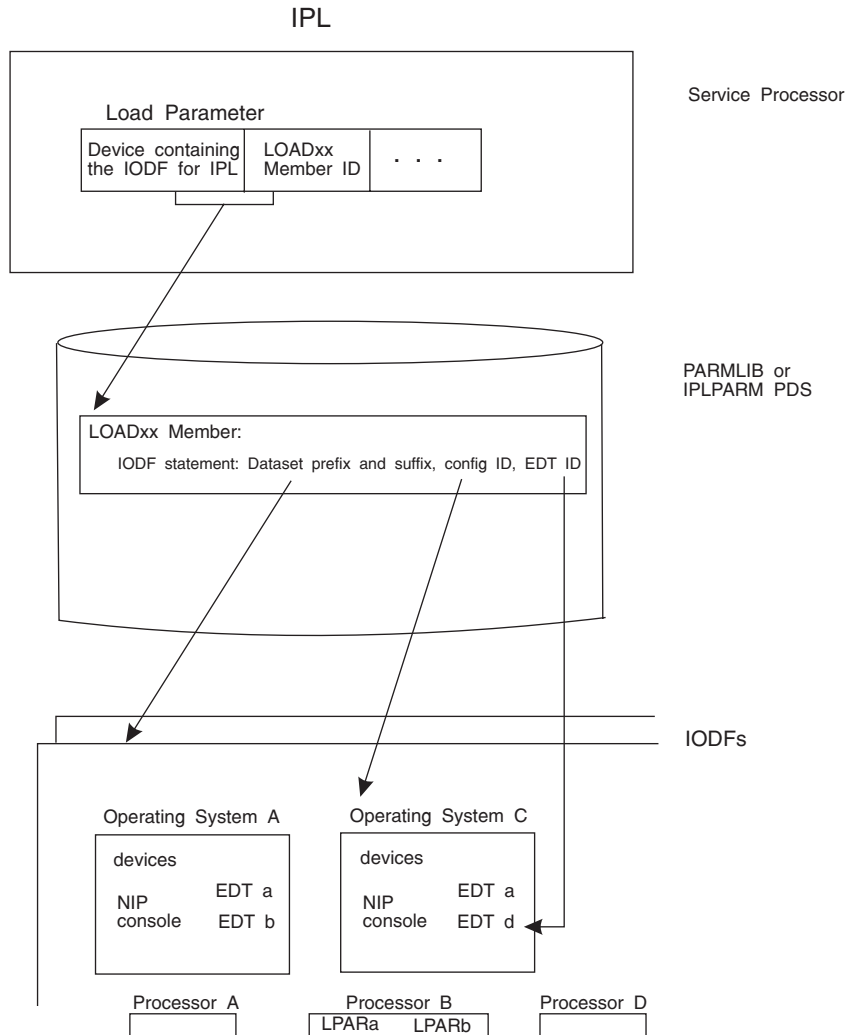

Figure 3-1. Specifying IODF at IPL

You can have multiple operating system and processor configurations in one IODF. The configurations can share common device definitions. In the IODF shown in the example, the configurations for operating system A and operating system C share EDT a.

IODF statement in the LOADxx member

A production IODF name has the following syntax:

```
<IODF-prefix>.IODF<IODF-suffix>
```

An example of a production IODF name is SYS2.IODF01.

You can specify the IODF prefix and suffix in the LOADxx statement to identify the production IODF at IPL. The IODF statement in the LOADxx member can contain the following information:

- IODF suffix
The IODF suffix is the 2-digit hexadecimal number that is part of the IODF name. For example, "01" is the IODF suffix for IODF01.
- IODF prefix

The IODF prefix is an 8-byte high-level qualifier of the IODF data set name. For example, IBMCONF is the IODF prefix for the IODF dataset IBMCONF.IODF01.

- Operating system (OS) configuration identifier

The 8-byte operating system configuration identifier is part of the configuration definition in the IODF; it identifies the operating system configuration.

- Eligible device table (EDT) identifier

The EDT identifier is the 2-digit hexadecimal number that identifies the EDT for use with the configuration defined by the IODF. If you do not specify an EDT identifier, it defaults to "00."

- LOAD option

The LOAD option is a field where you indicate if the system will load device support code for every UIM whether a device of that type is installed or not. If you leave the field blank or specify Y, the system loads all the device support modules for the devices in the IODF and all device types that support dynamic configuration for which you have UIMs installed. This option enables you to add device types dynamically that were not in the IODF at IPL. When you specify any other character, the system loads only the modules required for the devices defined in your current IODF.

Search order for the LOADxx member and IODF

During IPL, the system uses the LOADxx member that it finds first when searching in the following order:

1. The system first searches the IODF volume for a SYSn.IPLPARM PDS where n is 0 through 9.
2. If it does not find SYSn.IPLPARM, it searches the IODF volume for a SYS1.PARMLIB PDS.
3. If it does not find SYS1.PARMLIB on the IODF volume, it searches for SYS1.PARMLIB on the sysres volume.

Specifying the IODF on the sysres volume is not recommended for the following reasons:

- It is difficult to replicate the sysres volume if it contains an IODF because an IODF is a VSAM data set.
- When you share the sysres volume across multiple systems, I/O contention occurs when the systems are IPLed. Having the IODF on the sysres volume adds to the contention.

The LOADxx member may reside on either the IODF volume or the SYSRES volume.

If MVS finds SYSn.IPLPARM or SYS1.PARMLIB, but it doesn't contain the LOADxx member in the LOAD parameter, MVS enters a wait state.

Specifying the IODF high-level qualifier: If LOADxx is in SYS1.PARMLIB, you must specify an IODF high-level qualifier in the IODF statement. If the LOADxx member is in SYSn.IPLPARM and the IODF statement does not contain a high-level qualifier, MVS defaults to the high-level qualifier of the SYSn.IPLPARM.PDS.

If you optionally specify equals (=====) as the IODF high-level qualifier in the IODF statement, MVS attempts to use the high-level qualifier from the hardware configuration token in the HSA. If the token is not available, MVS loads wait state X'0B1', with reason code X'00B'. If the high-level qualifier found in the hardware configuration token contains a blank in the first character, MVS loads wait state X'0B1', with reason code X'009'.

Specifying the IODF suffix: You can optionally specify an IODF suffix and operating system configuration ID in the IODF statement in LOADxx, or you can let MVS find the correct IODF automatically. This automatic search saves you from having to change the LOADxx member every time you switch IODFs. However you might have to rename the suffix of the IODF so that MVS will find it first in its search sequence.

The IODF search options (++, --, ==, **, and bb(blank blank)) provide flexibility in IODF management. You can set up LOADxx so that you do not have to change it, following every dynamic configuration and IOCDs update, for use at the next IPL. Users, who want to maintain a back-up IODF on a second volume in case of device failure, can use the flexible searching algorithm. This allows the backup IODF name to have the next larger or lower sequential number as a suffix.

Table 3-1 describes the options you can use when identifying the IODF and operating system configuration ID for IPLing the system.

When you specify asterisks, pluses, minuses, or equals as the IODF suffix, MVS uses the IODF name in the hardware configuration token in the HSA. If you override the descriptor fields (when building a production IODF using HCD panels) and specify an invalid IODF name, the token in the HSA is unusable. In this situation, MVS searches for a valid production IODF as follows:

- For '**' and '++', MVS searches suffixes X'00' to X'FF' for a valid IODF
- For '--', MVS searches suffixes X'FF' to X'00' for a valid IODF
- For '==', MVS loads wait state X'0B1', with reason code X'00B'

Attention: If you are specifying asterisks, equals, pluses, or minuses for the IODF suffix in LOADxx, never change the default descriptor field values on the HCD panel when you create a production IODF because MVS uses this information to find the current IODF. Also, make it a policy to always write a new IOCDs after a dynamic configuration change.

Table 3-1. Specifying an IODF for IPL

What You Can Specify in the IODF Statement	How MVS Finds the IODF at IPL	How to make sure MVS finds a new IODF at IPL
Asterisks '**' for IODF suffix	MVS uses the IODF that you were running with. If you are IPLing initially or MVS cannot find a current IODF, MVS will behave as if you left the IODF suffix blank.	When you activate a different IODF, you do not have to change LOADxx or rename IODF suffixes.
Pluses '++' for IODF suffix	MVS uses the IODF that you were running with. If you are IPLing initially or there is no current IODF, MVS behaves as if you left the IODF suffix blank. If the current IODF is not available, MVS searches for the next available IODF starting with the current IODF suffix number plus one and searches to X'FF'. If none is found, the search continues from X'00' up to the current IODF number.	When you activate a different IODF, you do not have to change LOADxx or rename IODF suffixes.

Table 3-1. Specifying an IODF for IPL (continued)

What You Can Specify in the IODF Statement	How MVS Finds the IODF at IPL	How to make sure MVS finds a new IODF at IPL
Minuses '---' for IODF suffix	<p>MVS uses the IODF that you were running with. If you are IPLing initially or there is no current IODF, MVS behaves as if you left the IODF suffix blank.</p> <p>If the current IODF is not available, MVS searches for the next available IODF starting with the current IODF suffix number minus one and searches to X'00'. If none is found, the search continues from X'FF' down to the current IODF number.</p>	When you activate a different IODF, you do not have to change LOADxx or rename IODF suffixes.
Equals '==' for IODF suffix	MVS uses the IODF that you were running with. If you are IPLing initially or there is no current IODF, MVS loads wait state X'0B1', with reason code X'00B'.	When you activate a different IODF, you do not have to change LOADxx or rename IODF suffixes.
You can specify both operating system configuration ID and IODF suffix.	<p>MVS uses the IODF with the specified suffix for the IPL. The IODF may contain multiple operating system configurations, MVS uses the specified one for the IPL.</p> <p>If an IODF with the specified suffix does not exist or does not contain the specified operating system configuration ID, MVS enters a wait state.</p>	<p>When you activate a different IODF or operating system configuration, you must:</p> <ul style="list-style-type: none"> • Change the suffix and configuration ID in the LOADxx member • Name the new IODF with the specified suffix and the operating system configuration with the specified ID.
You can specify an operating system configuration ID and leave the IODF suffix blank.	<p>MVS searches the IODFs in numerically ascending order starting with IODF00 and continuing through IODFFF until MVS finds an IODF that contains the specified operating system configuration ID.</p> <p>If an IODF with the specified operating system configuration does not exist, MVS enters a wait state.</p>	You need to make sure that the IODF that you want MVS to find is the first one in the sequence that has that operating system configuration ID. If you activate a different IODF, you might have to change IODF suffixes so that IODF is the first one found.
You can specify an IODF suffix and leave the operating system configuration ID blank	<p>MVS uses the IODF with the specified suffix as long as that IODF only contains a single OS configuration.</p> <p>If that IODF contains more than one operating system configuration, MVS enters a wait state.</p>	<p>When you activate a different IODF, you must do one of the following:</p> <ul style="list-style-type: none"> • Change the suffix in the LOADxx member • Name the new IODF with that suffix.
You can leave both the operating system configuration ID and IODF suffix blank	MVS uses the IODF that it finds by searching in numerically ascending order starting with IODF00 for the first IODF that contains a single operating system configuration ID.	If you activate a different IODF, you do not have to change the LOADxx member but you do have to make sure that the new IODF will be the first one that MVS finds by renaming the IODFs.
<p>Note: If you specify asterisks, pluses, minuses, or equals, for the IODF suffix, do not change the default values for the descriptor fields when you create a production IODF. MVS uses the default information to find the IODF.</p>		

If you do not specify an '***', '++', '---', or '==' for the IODF suffix, when MVS finds the IODF, it checks whether the IODF contains a hardware I/O configuration definition that matches the representation used by the channel subsystem. Whether it matches determines the kind of configuration changes you can make. If it does

match, you can change both hardware and software definitions. If it does not match, you can make only software configuration changes. To enable changes to the hardware configuration definition, you can make a software-only dynamic change that activates an IODF containing the correct hardware I/O configuration definition.

Specifying an operating system configuration ID: If you also specify an operating system configuration ID in the IODF statement, the IODF may contain multiple operating system configurations and MVS uses the specified one. If you do not specify an operating system configuration, then the IODF should contain only one operating system configuration. If the IODF contains more than one operating system configuration, MVS enters a wait state.

Specifying the EDT identifier: If you are letting MVS find the correct IODF automatically and you do not specify an EDT identifier, MVS uses '00' as the identifier. To ensure that an IODF with the identified EDT exists, you can either specify an EDT identifier and put that EDT in each IODF or put an EDT with a '00' identifier in each IODF.

Defining your I/O configuration for re-IPL

Defining a configuration for re-IPL is an exception or recovery task. The only times you would not perform a dynamic change are:

- When you are installing a device that does not support dynamic capability
- When you are installing a new product and no device code for it is resident
- When you need to re-IPL the system after a system outage

Take the following general actions to define your configuration at re-IPL:

1. Reconsider the SQA and CMB parameter values in case they need to be increased due to additional devices being added to the configuration.
2. Update or create the LOADxx member so the new production IODF will be selected at IPL. This step is optional if you let the system find it by not specifying the IODF suffix. If you specify '***', '++', '--', or '==' for the IODF suffix, MVS uses the IODF that was the last active IODF. If you use asterisks for the IODF suffix, make sure that you always write a new IOCDs after a dynamic change and that you never change the default values of the descriptor fields when you create a production IODF.

Chapter 4. Dynamically changing an I/O configuration

Before you change your configuration dynamically, make sure that your system has migrated to dynamic capability. Until your installation updates its affected application programs or installs updated products to support dynamic configuration, define any devices that support dynamic configuration as installation-static so that the programs that do not support dynamic configuration can continue to use the devices. For migration information, see “Migrating to the dynamic capability provided with HCD” on page 4-18.

Actions to change your configuration dynamically

The following general actions are performed to define a configuration dynamically:

1. Verify that each I/O device that you plan to delete is not needed by any application or logical partition by varying the I/O device offline.
2. Check that the current software I/O configuration definition matches the hardware I/O configuration.

You can check that the definitions match by testing an activation of a hardware and software change. When the activation specifies configurations that do not match, the test function displays an error message. See “Testing dynamic activation” on page 4-22 for more information about testing an activation.

3. Attempt to change the (current) active production IODF.

This action will cause HCD to create a new work IODF.

4. Change the work IODF to define the new I/O configuration.

Along with specifying other information about the configuration, you use HCD to define as DYNAMIC “Yes” each device that you want to be able to dynamically change. DYNAMIC “Yes” is not required to add a device dynamically but is required to change or delete it. See “Making dynamic changes to I/O devices” on page 4-8 for more information about defining devices dynamically.

5. Create a production IODF from the work IODF.
6. If desired, physically remove the devices that you are deleting.
7. Update or create the LOADxx member so the new production IODF will be selected at IPL. This step is optional if you let the system find it by not specifying the IODF suffix. If you specify '***', '++', '- -', or '===' for the IODF suffix, MVS uses the IODF that was the last active IODF. If you use asterisks, make sure that you always write a new IOCDs after a dynamic change and that you never change the default values of the descriptor fields when you create a production IODF. See “IODF processing at IPL” on page 3-5 for more information.
8. Optionally, test the configuration before you actually activate it. See “Testing dynamic activation” on page 4-22 for more information about testing an activation.
9. Activate the new IODF.

See “Dynamically changing an I/O configuration in LPAR mode” on page 4-2 for a description of activating changes in logical partitions. For a software and hardware dynamic activation, the software and hardware configurations must match. When they match, activation occurs. When they do not match, activation does not occur.

See “Dynamically changing an I/O configuration in a sysplex” on page 4-7 for planning considerations before you dynamically activate configurations in a sysplex.

10. If desired, install the new I/O components.
11. Use HCD to write a new IOCDS for the new default IOCDS at the next POR.
12. Optionally, use HCD to create a backup copy of the new production IODF in case you lose your DASD.
13. Update the standard configuration list (CONFIGxx) member in SYS1.PARMLIB to reflect the new configuration definition.

You can use the configuration defined in CONFIGxx to compare the differences between the current configuration and the standard configuration as defined in a CONFIGxx member. When the operator issues the DISPLAY command with the M=CONFIG(xx) option, the system displays any differences.

Enter the Display command (D M=CONFIG(xx)) to view any differences caused by the dynamic configuration change and update the CONFIGxx member to reflect the new definition. See *z/OS MVS Initialization and Tuning Reference* for a description of the statements/parameters for CONFIGxx.

14. You can also use HCD to build the CONFIGxx member from a configuration in the IODF, and to process the DISPLAY M=CONFIG(xx) command. For additional information, see *z/OS HCD User's Guide*.
15. Use HCD to create a stand-alone IOCP input tape for ES/9000 PCE recovery support.

The tape can be used for recovery if you lose the disk holding the IOCDS in the processor controller. See *z/OS HCD User's Guide* for a description of creating an IOCP input data set.

See “Dynamically changing component definitions” on page 4-8 for more specific information for the type of I/O component you are defining. See “Recovery during dynamic configuration” on page 4-23 for a description of the steps to take to recover if your system fails while making a dynamic configuration change.

Dynamically changing an I/O configuration in LPAR mode

When a processor is running in LPAR mode, any single logical partition can make dynamic configuration changes that affect the hardware configuration for all the other logical partitions. To eliminate unwanted disruption across logical partitions (to not delete hardware I/O components that are in use by another logical partition), you must follow these steps:

1. In all logical partitions **except one**, use HCD panels to make software-only changes. (See “Making software-only dynamic changes” on page 1-9.) Think of the software only changes in these partitions as step 1. In the HCD panels, activate the “software definitions only and validate hardware changes” option. You can also use the MVS ACTIVATE command with the SOFT option. As you make the software-only changes to each logical partition, the system validates that the I/O components being deleted are not in use.
2. In the **remaining** one logical partition, use HCD panels to make both hardware and software changes. (See “Making both hardware and software dynamic changes” on page 1-8.) Think of the hardware and software change in this remaining partition as step 2. In the HCD panels, activate “hardware and software definitions”. You can also use the MVS ACTIVATE command and omit the SOFT option.

Notes:

1. To prevent you from inadvertently deleting I/O and coupling facility components that another logical partition is using, HCD only allows you to delete I/O and coupling facility components when you specify “Yes” in the “Allow hardware deletes (FORCE)” field on the Activate New Configuration panel. You can also use the ACTIVATE command to either dynamically test or activate a new I/O configuration definition. To delete components, use the FORCE attribute on the ACTIVATE command. (See *z/OS MVS System Commands*.)
2. If you are certain that a dynamic configuration change will not affect a particular logical partition, you do not need to make software-only changes to that logical partition.
3. If any logical partitions are running operating systems other than MVS/ESA SP 4.2 (or later), those logical partitions might be affected by activated dynamic configuration changes. Therefore, do not delete any I/O component required by any of those partitions without first making sure that I/O component is offline. If one of those partitions is using an I/O component you are deleting, that partition, through interface-control or channel-control check, terminates all active operations using that I/O component.
4. When changing coupling facility devices and control units be careful to activate the correct IODF in step 1. If you activate an incorrect IODF and the system displays message IOS500I with a note indicating that the IODF does not contain a configuration definition that matches the current hardware definition, you must perform the following steps:
 - 1) In the step 1 partition, activate the previous IODF to reset the configuration definition to its previous state.
 - 2) In the step 1 partition, activate the correct IODF.
 - 3) In the step 2 partition, perform the software and hardware change.

If the system does not display the note on the IOS500I message, you can activate the correct IODF in the step 1 partition and perform the software and hardware change in the step 2 partition.

Example of deleting an I/O device in LPAR mode

For the sample processor running in LPAR mode shown in Figure 4-1 on page 4-4, assume the following:

- You wish to delete device 000F.
- The current production IODF is SYS1.IODF14.

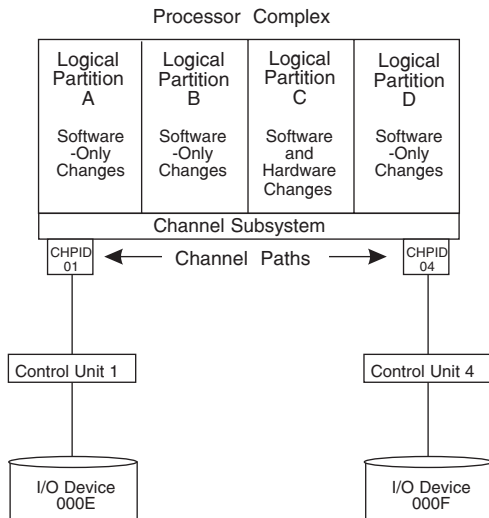

Figure 4-1. Sample Processor Running in LPAR Mode

In this example, you would make dynamic changes through the following steps:

1. Make sure device 000F supports dynamic configuration.
2. Make sure device 000F has been defined as dynamic.
3. Use HCD panels to create a new production IODF (SYS1.IODF15) that omits the device F definition. (See *z/OS HCD User's Guide*.)
4. Make software-only dynamic changes in logical partition A. (See "Making software-only dynamic changes" on page 1-9.)
5. Make software-only dynamic changes in logical partition B.
6. Make software-only dynamic changes in logical partition D.
7. Make hardware and software dynamic changes in logical partition C. (See "Making both hardware and software dynamic changes" on page 1-8.)
8. Physically remove device F.

Dynamically changing an I/O configuration on a z990 processor

The z990 processor supports multiple LCSSs. A z/OS system at the z990 exploitation support level can do a dynamic ACTIVATE of hardware for any LCSS. However, that a system running on the z990 with z990 compatibility support installed can only use a dynamic ACTIVATE to make hardware changes to an LCSS of zero (with some restrictions, as shown in the pictures below).

If you must make a hardware change to anything in LCSS other than 0, you must do a power-on reset (POR), or do the hardware ACTIVATE from a system that has the z990 exploitation support installed.

Figure 4-2 on page 4-5 shows a system with compatibility support installed. This system can do a dynamic ACTIVATE to make hardware changes to LCSS 0, but not to LCSS 1:

z/OS with z990 compatibility support

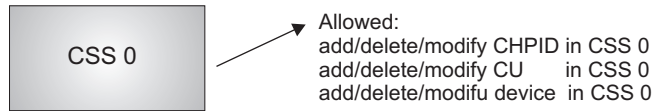

z/OS with z990 compatibility support

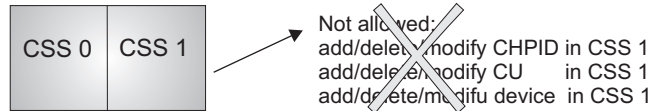

Figure 4-2. Dynamic I/O reconfiguration management on a z990 with compatibility support

If you have defined two LCSSs, you can add resources using a dynamic ACTIVATE to LCSS 0, as long as the resources are not shared (spanned) with LCSS 1.

Figure 4-3 shows how you can add CHPID 10 to LCSS 0. It also shows that you **cannot** add CHPID 20 to LCSS 0, because it is shared with LCSS 1 (spanned).

See “Defining spanned channel paths” on page 2-24 for information.

Figure 4-4 on page 4-6 shows how you can add control units and devices to LCSS

z/OS with z990 compatibility support

CHPID 20 defined to CSS 1

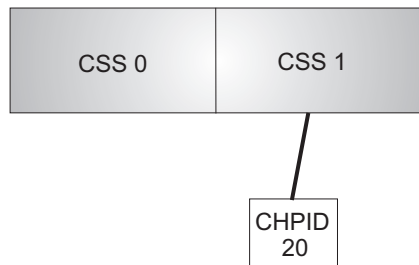

Now, you can do a Dynamic ACTIVATE to add CHPID 10 to CSS 0. However, an ACTIVATE to add CHPID 20 to CSS 0 does not work - CHPID 20 is already defined to CSS 1

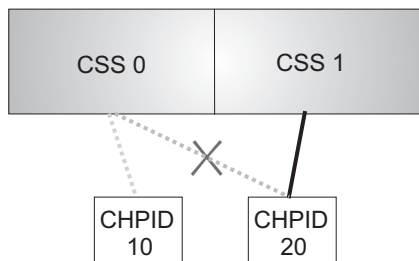

Figure 4-3. Dynamically adding CHPIDs in a two LCSS environment on a z990 with compatibility support

0, unless they are already defined to LCSS 1:

z/OS with z990 compatibility support

We start with:

CHPID 30 defined to CSS 0
CHPID 40 defined to CSS 1

Now, you can do a Dynamic ACTIVATE to add control unit B000 and devices B000-FF to CSS 0.
But you cannot do an ACTIVATE to add control unit B100 and devices B100-FF to CSS 0, because they're already defined to CSS 1

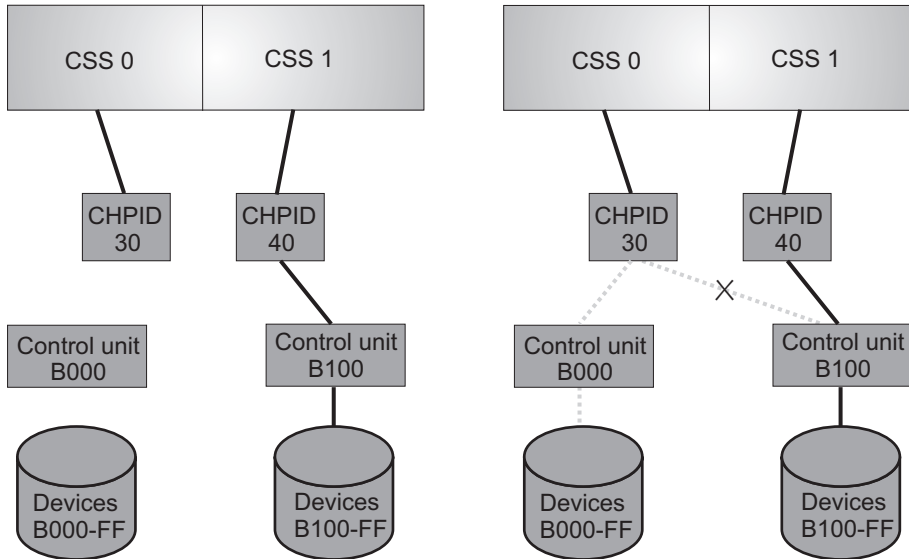

Figure 4-4. Dynamically adding control units and devices in a two LCSS environment on a z990 with compatibility support

Figure 4-5 on page 4-7 shows how you can change some resource attributes for LCSS 0. You can:

- For CHPID 20, you can do an ACTIVATE to change candidate or access list for LCSS 0. You cannot remove the last partition from the candidate list.
- For control unit B000, you use an ACTIVATE to add or delete CHPIDs. You cannot remove or change all the CHPIDs for a control unit.
- For device B000-FF, you can use an ACTIVATE to change the candidate list or preferred path. You cannot remove the last partition from the candidate list for a device.
- If a control unit is already defined to LCSS 0, you can add devices to it, even if they are shared with LCSS 1.

z/OS with z990 compatibility support

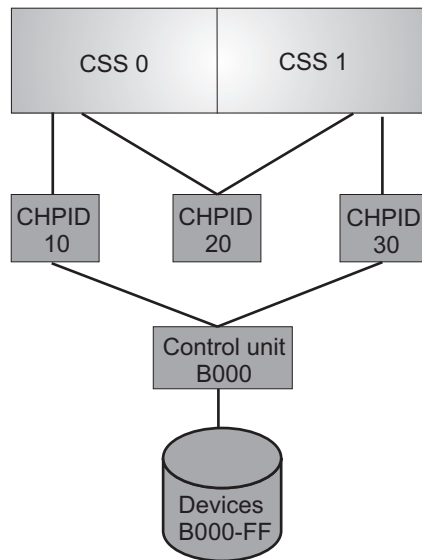

Figure 4-5. Dynamically adding shared resources in a two LCSS environment on a z990 with compatibility support

Dynamically changing an I/O configuration in a sysplex

You can use HCD as a single point of control to dynamically activate an I/O configuration on one or more systems configured in a sysplex. To determine the supported processors, run the HCD Supported Hardware Report. For information about running reports, see *z/OS HCD User's Guide*.

Using the “Activate configuration sysplex-wide” option on the HCD Activate and Process Configuration Data panel, you can make software-only changes as well as software and hardware changes to one or more systems from a system in your sysplex.

Consider the following requirements before you activate your sysplex-wide configuration changes:

- You can perform a sysplex-wide activation only on a system that is running and is configured in the sysplex couple data set. See *z/OS MVS Setting Up a Sysplex* for more information about sysplex couple data sets.
- In order for a sysplex-wide activation to work on a system, the system must allow software configuration changes. To verify that a system allows software configuration changes, select the “Activate or process configuration data” option on the HCD Primary Task Selection panel and then the “View active configuration” option on the HCD Activate and Process Configuration Data panel on that system. HCD displays the currently active IODF, the HSA token, and information about limitations to the activation scope.

After you initiate a sysplex-wide activation, respond to any activation messages.

Dynamically changing component definitions

You can dynamically add, modify, or delete components in the configuration. You can make software and hardware changes or software-only changes. In most cases, you will make simultaneous dynamic configuration changes to both hardware and software configuration definitions. The following sections describe how to dynamically change component definitions. For software-only changes, you do not have to perform all the steps. It is noted when the step is not required for a software-only change.

Any dynamic configuration addition, modification, or deletion requires the following two general steps:

- Describe the new I/O configuration definition in an I/O definition file (IODF) that you create through HCD. See *z/OS HCD User's Guide*.
- Activate the new IODF.

You can use either HCD panels or the ACTIVATE command to dynamically activate or test a new I/O configuration definition. Generally, system programmers use HCD and system operators use the ACTIVATE operator command. To use HCD panels, see *z/OS HCD User's Guide*. To use the ACTIVATE command, see *z/OS MVS System Commands*.

Notes:

1. For software/hardware changes: Make sure that you activate “hardware and software definitions”. Also, write a new I/O configuration data set (IOCDS) for the new default IOCDS at the next POR.
2. For software-only changes: Make sure that you activate “software definitions only.” You can also choose to “validate hardware changes,” which validates that I/O components being deleted are not in use.

Additional steps related to specific I/O components are described in

- “Making dynamic changes to I/O devices”
- “Making dynamic changes to channel paths” on page 4-12
- “Making dynamic changes to control units” on page 4-14

Coupling facility device and control unit definitions in the IODF are created or deleted automatically when coupling facility channel paths are connected or disconnected. See “Making changes to coupling facility devices and control units” on page 4-16.

Making dynamic changes to I/O devices

You can dynamically add, modify, or delete device definitions. Remember that devices defined as installation-static can still be dynamically added.

Dynamically adding I/O devices

To dynamically add an I/O device, use the following general steps:

1. For each device that you plan to add, make sure its device support code was loaded at the last IPL.

There are two ways which device support code is loaded at IPL. The choice made at the last IPL can determine whether the device support code is loaded for the device that you want to add. Through the IODF statement in the LOADxx member of SYS1.PARMLIB, or SYSn.IPLPARM, for the last IPL, you might have chosen either of the following:

- To load, at IPL, all the dynamic device support code in SYS1.NUCLEUS.

This choice, which is the default, allows you to dynamically add any device that supports dynamic configuration.

- To load, at IPL, device support code for only those device types defined in the IODF. This choice allows you to dynamically add only those device types that were defined in the IODF.

If you add a new device and the device support code for that new device was not loaded at IPL, your system cannot use that device. Before your installation can use that device, you must re-IPL the system to load the device support code.

For details about specifying your choice at IPL, see “IODF processing at IPL” on page 3-5.

2. Describe the new I/O configuration definition in an I/O definition file (IODF) that you create through HCD. Including an I/O component in an IODF adds that I/O component’s definition to the I/O configuration definition.
3. Activate the new IODF.
4. Install the new I/O devices that you have dynamically added through the new IODF. As required, format the I/O devices.

Besides these general actions to add a device, other actions might be required to make certain devices usable. For example, adding a direct access storage device (DASD) to support a page data set requires the following actions:

1. For the DASD that you plan to add, make sure device support code was loaded at the last initial program load (IPL).
2. Create a new I/O definition file (IODF) that defines the DASD to both hardware and software.
3. Activate the new IODF.
4. Install the DASD.
5. Run the ICKDSF program to format a volume on the DASD.
6. Vary the DASD online to MVS.
7. Run IDCAMS to define the page data set on the DASD.
8. Issue the PAGEADD command to add the page data set.

MVS directs paging activity to the volume.

Note: You can add a new bank of DASD using the same procedure, but perform the steps for all the DASDs in the bank.

Dynamically deleting I/O devices

To dynamically delete an I/O device, use the following general steps:

1. For each device that you plan to delete, make sure that it is not needed by any application running in the processor. In a Processor Resource / System Management (PR/SM) environment, this includes applications running in any logical partition in your processor. See “Dynamically changing an I/O configuration in LPAR mode” on page 4-2.
2. For each device that you plan to delete, make sure that it is offline and not in use. CTC and TP devices must also not be allocated.
3. Describe the new I/O configuration definition in an I/O definition file (IODF) that you create through HCD. Omitting an I/O component from an IODF deletes that I/O component’s definition from the I/O configuration definition.
4. Physically remove the I/O devices that you have dynamically deleted through the new IODF.

Note: This step is not required for a software-only change.

5. Activate the new IODF.

Besides these general actions to delete a device, other actions might be required for certain devices. For example, deleting a DASD that contains only one page data set requires the following actions:

1. Make sure the DASD that you plan to delete is not needed by any application.
2. Create a new IODF that **does not** define the DASD.
3. Issue the PAGEDEL command.
MVS displays message IEE206I to indicate that the page delete request is accepted and in progress.
When the delete request completes, MVS displays message IEE205I to indicate that the page data set is deleted.
4. Issue the DISPLAY UNITS command to see whether or not the device that held the page data set is unallocated.
5. After the device is unallocated, vary it offline to MVS.
6. Physically remove the DASD.
7. Activate the new IODF.

This procedure deletes the DASD definition from MVS and HSA.

Note: You can delete a bank of DASD using the same procedure, but perform the steps for all the DASDs in the bank.

Dynamically changing I/O devices

To dynamically change a device, use the following general steps:

1. For devices that you plan to change, if you are changing certain fields in the IODF, you must vary devices offline.

To guard against losing I/O access unexpectedly, you must vary offline I/O devices before you activate an IODF that changes the characteristic fields described in Table 4-1. You might need to cancel applications that have a device allocated to get the device offline and TP and CTC devices must also be unallocated. To change the number of alias UCBs, you must change the control unit type and the device type of all the devices attached to the control unit at the same time. This action requires that all the devices for the control unit are offline at the same time.

Table 4-1. Dynamic I/O Offline Requirements for Device Characteristic Fields

Vary the affected I/O components offline before activating a new IODF that changes these device characteristics:	Before activating the new IODF, take the following actions:
<ul style="list-style-type: none"> • Unit Address • Device Type 	In each logical partition that can access the I/O device, vary the I/O device offline.
<ul style="list-style-type: none"> • Connected to CUs 	In each logical partition that will lose access to this I/O device, vary the I/O device offline. In each logical partition that will be able to access the I/O device through other control units, vary offline only the logical paths associated with the control unit.
<ul style="list-style-type: none"> • Device Candidate List 	In each logical partition that will lose access to this I/O device, vary the I/O device offline.

You do **not**, however, have to vary an I/O device offline before activating an IODF when you change any of the following I/O device characteristics:

- Serial Number
 - Description
 - TIME OUT
 - STADET
 - Preferred CHPID
2. Describe the new I/O configuration definition in an I/O definition file (IODF) that you create through HCD.
 3. Activate the new IODF.

Limitations on dynamic changes to I/O devices

Even though a device supports dynamic configuration, the system environment might not allow dynamic changes that would add, modify, or delete the device definition.

- You cannot dynamically add certain devices. These include devices for which device support code was not loaded at IPL.
- You cannot dynamically modify or delete certain devices. These include devices containing data sets that you must never unallocate, such as the device containing the system residence volume or a device that contains a data set in the link list concatenation. Examples of data sets that you must never unallocate include:
 - Common page data sets
 - LPA page data sets
 - SYS1.LINKLIB
 - SYS1.MIGLIB
 - The logrec data set
 - The VIO journaling data set

Other factors that determine whether or not you can use dynamic configuration for a device include:

- A product or program can use a device without accessing it through allocation. If a device supports dynamic configuration, but a product or program that uses that device does not support dynamic configuration, you must not define that device as dynamic. See “UCB services considerations” on page 4-19.

Note: Do not define devices that contain control volumes (CVOLs) as dynamic devices; define them only as installation-static.

- If you plan to use a pair of devices in a dynamic device reconfiguration (DDR) swap, both devices must have the following two attributes in common:
 - Whether the device type supports dynamic configuration
 - Whether the device is defined as dynamic

Any dynamic change that causes a device’s UCB to be deleted and added again, causes the device’s MIH time interval to be reset to the default MIH setting for its device class. To reestablish the previous MIH interval, issue the MVS command SETIOS MIH when the dynamic change is completed. For information about this command, see *z/OS MVS System Commands*.

Console devices: You can define console devices as dynamic; however:

- You can dynamically delete or modify any device that was defined as a console in the CONSOLxx member of SYS1.PARMLIB at IPL only after the console

definition has been removed from the system by IEAVG730 or IEARELCN. For more information on removing a console using these methods, see *z/OS MVS Planning: Operations* .

- You cannot use any dynamically added device as an MCS console.

Considerations for MVS installed products

Certain products installed with MVS require that you take additional steps to define a configuration change to the product. If you do not take these additional steps before making a dynamic configuration change, the configuration defined to these products might be out of synchronization with the MVS configuration definition.

After you dynamically add an I/O device to MVS, define it to other products through their specific interfaces for defining I/O configurations. For example, to add a Virtual Telecommunications Access Method (VTAM) device:

1. Dynamically add the VTAM device to MVS.
2. Create a new telecommunication program (TP) topology that includes the VTAM device you are adding.
3. Define that new TP topology to VTAM.

When you delete an I/O device definition, first remove the definition from the related product, then delete the I/O device from MVS by activating a new configuration definition. For example, to delete a VTAM device:

1. Create a new TP topology that does not include the device you are deleting.
2. Define that new TP topology to VTAM.
3. Dynamically delete the VTAM device from MVS.

Making dynamic changes to channel paths

You can add, modify, and delete channel path definitions. If you define a device as static or installation-static, you cannot delete or modify the channel path definition to that device.

Using an IBM @server zSeries 900 or later processor, you will be able to dynamically add, delete, or modify coupling facility receiver channels and coupling facility peer channels. For a S/390 9672 Parallel Transaction Server, you cannot dynamically add, delete, or modify coupling facility receiver (CF receiver) channels. However, at POR, you could define more CF receiver channels than are currently connected to coupling facility sender channels. Later, to create more connections from an operating system to the coupling facility, you can activate an IODF that dynamically adds CF sender channels connected to the defined CF receiver channels.

Dynamically adding channel paths

To dynamically add a channel path, use the following general steps:

1. Describe the new I/O configuration definition in an I/O definition file (IODF) that you create through HCD. Including a channel path in an IODF adds that I/O component's definition to the I/O configuration definition.
2. Activate the new IODF.
3. Install the new I/O components that you have dynamically added through the new IODF. As required, configure the channel paths.

Dynamically deleting channel paths

How you dynamically delete a channel path depends on whether or not that channel path shares any control units and devices with one or more other channel paths.

To delete a channel path that *is* the only channel path attached to *all* its devices and control units, use the following general steps:

1. Describe the new I/O configuration definition in an I/O definition file (IODF) that you create through HCD. Create an IODF that defines neither the channel path nor its devices and control units.
2. Make sure the channel path and its devices and control units are not in use by any application.
3. Vary all I/O devices on the channel path offline to MVS.
4. Configure the channel path offline to MVS.
5. Physically remove the channel path and all I/O devices and control units on the channel path.
6. Activate the new IODF.

To delete a channel path that is *not* the only channel path attached to its devices and control units, use the following general steps:

1. Describe the new I/O configuration definition in an I/O definition file (IODF) that you create through HCD. Create an IODF that meets both of the following requirements:
 - The new IODF does not define the channel path or the devices and control units attached exclusively on the channel path.
 - The new IODF does define those device and control units also attached on other channel paths.
2. Make sure that no devices and control units on this channel path are in use by this channel path.
3. For all devices not exclusively on this channel path, vary offline to MVS all device paths through this channel path.
4. Vary offline to MVS all devices exclusively on this channel path.
5. Configure the channel path offline to MVS.
6. Physically remove the channel path and the I/O devices and control units **exclusively** on this channel path.
7. Activate the new IODF.

There is a consideration when you delete CF sender channel paths. If a coupling facility is defined in the coupling facility resource management (CFRM) policy and has working connections from an MVS system to the coupling facility, you cannot make dynamic changes that cause a loss of connectivity to the facility. For example, you cannot dynamically delete the last operational coupling facility channel path.

To delete the last channel path connected to the coupling facility, use the following general steps:

1. If the coupling facility is in the current CFRM policy, activate a new policy that does not specify the coupling facility. See *z/OS MVS Setting Up a Sysplex* for information about setting up and activating the CFRM policy.
2. Configure the channel path offline to MVS.
3. Physically remove the channel path.
4. Activate a new IODF.

Dynamically changing channel paths

To dynamically change a channel path, use the following general steps:

1. For channel paths that you plan to change, if you are changing **certain** fields in the IODF, you must configure channel paths offline.

To guard against losing I/O access unexpectedly, you must vary offline I/O devices before you activate an IODF that changes the characteristic fields described in Table 4-2:

Table 4-2. Dynamic I/O Offline Requirements for Channel Path Fields

Vary the affected components offline before activating a new IODF that changes these channel path characteristics:	Before activating the new IODF, take the following actions:
<ul style="list-style-type: none"> • Channel Path Type • Dynamic Switch ID • Operation Mode 	<p>In all logical partitions in your processor complex, configure the channel path offline. If the channel path is the last path to an I/O device, you must vary the device offline before you can configure the channel path offline.</p>
<ul style="list-style-type: none"> • Channel Path Access List • Channel Path Candidate List 	<p>In each logical partition that will lose access to I/O devices on this channel path, do the following:</p> <ol style="list-style-type: none"> 1. For I/O devices that will become inaccessible to the logical partition, vary those I/O devices offline. 2. For I/O devices that will remain accessible by the logical partition through other channel paths, vary offline only the logical paths associated with this channel path. 3. Configure the channel path offline. Note: For coupling facility sender channel paths, you must first vary the CF sender channel path offline to the coupling facility. <p>In all logical partitions that will gain access or continue accessing this channel path, you need not configure or vary anything offline.</p>

You do **not**, however, have to vary an I/O device offline before activating an IODF when you change any of the following I/O device characteristics:

- Entry Switch Number
 - Entry Port
 - Description
2. Describe the new I/O configuration definition in an I/O definition file (IODF) that you create through HCD.
 3. Activate the new IODF.

Note: You usually cannot remove a logical partition from a channel path candidate list unless the channel path is offline. You can, however, remove a logical partition, other than your own, from the channel path candidate list for a reconfigurable or shared ESCON connection (CNC and CTC) or coupling facility sender channel path while the channel path is online to the other logical partition if you perform one of the following actions:

- Use the ACTIVATE command with the FORCE(CANDIDATE) parameter.
- On the HCD Activate New Hardware and Software Configuration panel, specify “Yes” in the “Delete partition access to CHPIDs unconditionally (FORCE=CANDIDATE)” field.

Making dynamic changes to control units

You can add, modify, and delete control unit definitions.

Dynamically adding control units

To dynamically add a control unit, use the following general steps:

1. Describe the new I/O configuration definition in an I/O definition file (IODF) that you create through HCD. Including an I/O component in an IODF adds that I/O component's definition to the I/O configuration definition.
2. Activate the new IODF.
3. Install the new I/O components that you have dynamically added through the new IODF. As required, configure the channel paths, format the I/O devices, and vary the I/O components online.

Dynamically deleting control units

MVS verifies that the control units are not in use (that the set of all device paths are offline) before deleting the control unit.

How you dynamically delete a control unit depends on whether or not that control unit shares any devices with one or more other control units.

To delete a control unit that is the only control unit attached to **all** its devices, use the following general steps:

1. Describe the new I/O configuration definition in an I/O definition file (IODF) that you create through HCD. Create an IODF that defines neither the control unit nor its attached devices.
2. Make sure that none of the devices on the control unit are in use by any application.
3. Vary all devices on the control unit offline to MVS.
4. Physically remove the control unit and all its attached devices.
5. Activate the new IODF.

To delete a control unit attached to any devices that are **also** attached to one or more other control units, use the following general steps:

1. Describe the new I/O configuration definition in an I/O definition file (IODF) that you create through HCD. Create an IODF that meets both of the following requirements:
 - The new IODF does not define the control unit or its exclusively attached devices.
 - The new IODF does define those devices also attached to other control units.
2. Make sure that none of the devices exclusively on this control unit are in use by any application.
3. Vary offline to MVS all devices exclusively on the control unit. For all devices also attached to other control units, vary offline to MVS all device paths through this control unit.
4. Physically remove the control unit and all its exclusively attached devices.
5. Activate the new IODF.

Dynamically changing control units

To dynamically change a control unit, use the following general steps:

1. For control units that you plan to change, if you are changing **certain** fields in the IODF, you must vary attached devices offline.

To guard against losing I/O access unexpectedly, you must vary offline I/O devices before you activate an IODF that changes the characteristic fields described in Table 4-3 on page 4-16:

Table 4-3. Dynamic I/O Offline Requirements for Control Unit Fields

<p>Vary the affected I/O components offline before activating a new IODF that changes these control unit characteristics:</p>	<p>Before activating the new IODF, take the following actions:</p>
<ul style="list-style-type: none"> • Control Unit Type • Link Address • Logical Address • Protocol • I/O Concurrency Level 	<ul style="list-style-type: none"> • Vary offline all I/O devices connected to the control unit.
<ul style="list-style-type: none"> • Channel Path IDs 	<p>In each logical partition that will lose access to I/O devices on this control unit, do the following:</p> <ol style="list-style-type: none"> 1. For I/O devices that will become inaccessible to the logical partition, vary those I/O devices offline. 2. For I/O devices that will remain accessible by the logical partition through other channel paths, vary offline only the logical paths that you are removing from this control unit.
<ul style="list-style-type: none"> • Unit Addresses (with Ranges and Numbers of Units) 	<p>Before deleting a unit address, vary its associated I/O device offline.</p>

You do **not**, however, have to vary an I/O device offline before activating an IODF when you change any of the following control unit characteristics:

- Serial Number
 - Description
2. Describe the new I/O configuration definition in an I/O definition file (IODF) that you create through HCD.
 3. Activate the new IODF.

Making changes to coupling facility devices and control units

Coupling facility devices and control units are defined to represent the connections in the channel subsystem connection to a coupling facility. The coupling facility control unit and device definitions are created in an IODF when you connect CF sender and CF receiver channel paths or two CF peer channel paths using HCD. One coupling facility control unit and two coupling facility devices are defined when you first connect a CF sender channel path to a CF receiver channel path for a coupling facility. Each subsequent channel connection adds two more coupling facility device definitions. For a CF peer channel connection, one control unit and seven CF device definitions are generated on one or on both sides of the connection depending on whether the sending function is used on only one or on both sides of the connection. You do not explicitly add or delete coupling facility devices and control units in the IODF; they are added and deleted based on the CF sender-to-receiver or peer-to-peer channel connections that you make.

To use the coupling facility after you make the connections, a CFRM policy containing the coupling facility must be active. See *z/OS MVS Setting Up a Sysplex* for information about setting up and activating a CFRM policy.

A CF sender-to-CF receiver or peer-to-peer connection can cause changes to a coupling facility control unit definition. The first path you connect adds the coupling

facility control unit and the last path you disconnect deletes the coupling facility control unit, but all other connections and disconnections of channel paths change the control unit definition.

The following sections describe how dynamic changes are made to coupling facility devices and control units when you connect and disconnect channel paths for a processor.

Making the first channel path connection for a coupling facility

When you connect the first CF sender channel path to a CF receiver channel path for a coupling facility, HCD creates a coupling facility control unit and two coupling facility device definitions in an IODF. When you connect the first two CF peer channel paths for a coupling facility, HCD creates a coupling facility control unit and seven coupling facility device definitions in an IODF.

Perform the following steps when you connect the first CF sender channel path or CF peer channel path:

1. In HCD, connect a CF sender channel path to a CF receiver channel path, or connect two CF peer channel paths.
2. Accept or change the control unit and device numbers HCD proposes.
3. Activate the new IODF.
4. Install the channel path.
5. To allow the system to use the coupling facility, activate a coupling facility resource management (CFRM) policy that defines the coupling facility, if one is not already activated.
6. Configure the channel path online.

Making subsequent channel path connections for a coupling facility

When you make subsequent CF sender-to-CF receiver channel path connections for a coupling facility, HCD creates two coupling facility device definitions in the IODF. When you make subsequent CF peer-to-peer channel path connections for a coupling facility, HCD creates seven coupling facility device definitions in the IODF. For both the CF sender channel path connection and the CF peer channel path connection, HCD also changes the existing coupling facility control unit definition to reflect the new channel path connection in the IODF.

Perform the following steps when you connect subsequent CF sender or CF peer channel paths:

1. In HCD, connect a CF sender channel path to a CF receiver channel path, or connect two CF peer channel paths.
2. Accept or change the device numbers proposed by HCD.
3. Activate the new IODF.
4. Install the channel path.
5. Configure the channel path online.

Breaking a channel path connection that is not the last connection to a coupling facility

When you disconnect a CF sender channel path connection that is not the last connection for a coupling facility, HCD deletes two coupling facility device definitions in the IODF. When you disconnect a CF peer channel path connection that is not the last connection for a coupling facility, HCD deletes seven coupling facility device definitions in the IODF. For both the CF sender channel path disconnection and the

CF peer channel path disconnection, HCD also changes the existing coupling facility control unit definition to reflect the channel path disconnection in the IODF.

Perform the following steps when you disconnect a CF sender or a CF peer channel path that is not the last channel path connection to the coupling facility:

1. Disconnect a CF channel path from the CF receiver channel path, or disconnect the two CF peer channel paths.
2. Configure the disconnected channel path offline.
3. Activate the new IODF.

Breaking the last channel path connection to a coupling facility

When you disconnect the last CF sender channel path connection for a coupling facility, HCD deletes a coupling facility control unit and two coupling facility device definitions in the IODF. When you disconnect the last CF peer channel path connection for a coupling facility, HCD deletes a coupling facility control unit and seven coupling facility device definitions in the IODF.

Note: If a coupling facility is defined in the active coupling facility resource management (CFRM) policy, you cannot dynamically delete the coupling facility control unit by disconnecting the last channel paths.

Perform the following steps when you disconnect the last CF sender channel path or the last CF peer channel path from a coupling facility:

1. Quiesce activity to the coupling facility by activating a CFRM policy that does not contain the coupling facility.
2. Disconnect the last CF sender or CF peer channel path from a processor to a coupling facility in the IODF definition.
3. Activate the new IODF.

Migrating to the dynamic capability provided with HCD

This section describes considerations for migrating to the dynamic capability provided in MVS/ESA SP 4.2 or later.

If you are migrating from MVSCP or MVS/ESA SP 4.1, before you can use dynamic configuration for the first time you must make some changes. You may be in one of the following situations:

- Migrating from MVSCP to HCD. For the detailed migration procedure for migrating to HCD, see *z/OS HCD User's Guide*.
- Migrating from an MVS release prior to 4.2 or up until this point had chosen not to use dynamic configuration capabilities.

Before you can use dynamic configuration in your installation, you must make these changes:

1. Convert the installation programs that perform UCB look-ups, scan UCBs, use unit verification services, and are sensitive to I/O configurations. See "UCB services considerations" on page 4-19.
2. Change the default of static to dynamic for any devices that you want to be able to change or delete from the software definition. (This change is not required to dynamically add a new device definition.) See "Specifying devices as dynamic after a migration" on page 4-21 for information about changing to dynamic devices that defaulted to static at migration.

If your installation has not prepared or is not going to use dynamic configuration, you must define devices that support dynamic configuration as installation-static.

Note: Installations that IPL with I/O definition files (IODFs) that define dynamic devices should use the IPCS subcommands FINDUCB, LISTUCB, and IOSCHECK to validate and display dynamic UCBs. Any other subcommands might not produce valid results. FINDUCB, LISTUCB, and IOSCHECK are also the subcommands to use for validating and displaying UCBs for devices that have changed from installation-static to dynamic through an ACTIVATE command.

UCB services considerations

There are considerations for accessing UCBs when you migrate to dynamic capability.

Converting references to UCB services for dynamic

If you wish to use dynamic configuration, and your installation has programs that obtain unit control block (UCB) addresses or use unit verification services, you must convert the programs to use services that support dynamic configuration. Also, you must understand the environment in which the services work.

Some old UCB services do not support 4-digit device numbers, UCBs that reside above 16 megabytes, or dynamic devices. These services are known as limited method UCB services:

- The IOSLOOK macro
- The UCB scan service (address in CVTUCBSC)
- The allocation unit verification service

As described in “Specifying an I/O device number” on page 2-28, a device number can be any hexadecimal number from X'0000' to X'FFFF'. You can use the limited method services to access only UCBs for devices whose device number is in the range X'0000' to X'0FFF'.

As described in “Defining an above 16 megabyte UCB” on page 2-38, you can use HCD to define a device's UCB above 16 megabytes if the device's unit information module (UIM) indicates that the device support code enables UCBs above 16 megabytes. You can use the limited method services to access only UCBs that reside below 16 megabytes (that is in 24-bit addressable storage).

As described in “Defining whether an I/O device will be dynamic” on page 2-32, devices can be defined as one of three different types:

- **Static:** cannot add, change, or delete a device to the software definition dynamically
- **Installation-Static:** can add, but cannot change or delete a device to the software definition dynamically
- **Dynamic:** can add, change, or delete a device to the software definition dynamically

If you define a device as static or installation-static, the limited method services can be used. If you define the device as installation-static, you can still dynamically add its UCB, making it accessible to your programs that use limited method UCB services. If you do not need to dynamically change or delete the UCB of a device that supports dynamic configuration, you can define that device as installation-static, and you do not need to change any applications.

If you want to have devices defined as dynamic, you must convert references to limited method UCB services to general method UCB services. If you have any application programs or products that need conversion, do not define devices as dynamic until you have converted the programs or installed the converted products. An application program that has not been converted cannot recognize devices defined as dynamic. To the application program, it appears as though the device is not defined to MVS.

Note: You do not need to change applications that access UCBs through TIOT or DEB fields.

To enable your programs to use and recognize UCBs that reside above 16 megabytes, or define dynamic devices or devices that have 4-digit device numbers, you need to replace:

- The IOSLOOK macro with the UCBLOOK macro.
- The UCB scan service (address in CVTUCBSC) with the UCBSCAN macro.
- The allocation unit verification service with the EDTINFO macro.

You also need to follow the new serialization requirements when using UCB services to obtain UCB addresses as described in “Consideration when accessing UCB data.” Table 4-4 lists the UCB services that replace services that do not support dynamic configuration. For more information on programming requirements for the services, see:

- *z/OS MVS Programming: Authorized Assembler Services Guide*
- *z/OS MVS Programming: Assembler Services Guide*

Table 4-4. Description of UCB Services

Configuration Service	Description
UCBLOOK	Obtains the UCB common segment address of a given device number or a given volume serial number.
UCBSCAN	Scans the UCBs.
UCBPIN	Prevents a UCB for a device and its associated device control blocks from being dynamically deleted (called pinning the UCB); allows the UCB and associated device control blocks to be unpinning when the program is finished using it.
IOCINFO	Returns the MVS I/O configuration token that indicates which configuration definition is active on MVS. The token can be used as input for other services to synchronously detect configuration changes.
CONFCHG	Requests notification of a dynamic configuration change.
EDTINFO	Obtains information from the EDT.

Consideration when accessing UCB data

When you use the UCB services to obtain UCB addresses, you need to ensure that the device is not dynamically deleted while you are obtaining information, because the UCB for the device and the related data structures would be deleted. For authorized programs, you can prevent the UCB from being deleted by pinning the UCB. See *z/OS MVS Programming: Authorized Assembler Services Guide* for information about pinning.

For unauthorized (and authorized) programs, you can prevent a UCB from being deleted by allocating the device. Also, for unauthorized programs, if you obtain a

copy of the UCB, a deletion of the original UCB does not affect the copy. You can obtain copies of a UCB through the UCBSCAN macro.

Note: It becomes the application's responsibility to detect when the real UCB has changed and the copy has become obsolete. This detection can be accomplished synchronously by using the MVS configuration token with the UCB services or asynchronously with the CONFCHNG exits.

Authorized MVS services with UCBs as input require the address of a UCB not the address of a copy of the UCB. Many unauthorized MVS services with UCBs as input do not accept addresses of UCB copies either. However they require that the devices be allocated which prevents the UCB from being deleted while in use anyway. You can pass addresses of UCB copies as input only to those unauthorized MVS services listed in "Services accepting a UCB copy."

To obtain UCB copies, you use the UCBSCAN macro with the COPY keyword. With the COPY keyword, you also need at least one other keyword. You can use either of the following keyword combinations:

- COPY and UCBAREA - The UCBAREA keyword specifies the address of a workarea that receives the UCB copy.
- COPY and UCBAREA and CMXTAREA and DCEAREA - The CMXTAREA and DCEAREA keywords specify the addresses of storage areas to receive tokens with the copy.

Services accepting a UCB copy

Some services accept copies and some accept copies but require tokens (from CMXTAREA and DCEAREA keywords) as part of the copies. The unauthorized DFSMS/MVS services that accept copies but do **not** require tokens as part of the copy are:

- LSPACE
- TRKCALC

The unauthorized DFSMS/MVS services that accept copies and require tokens as part of the copy are:

- CVAFTST
- DEVTYPE

Note: You can use these unauthorized DFSMS/MVS services with UCB copies only with DFSMS/MVS.

Use macro IHADFA to check the DFSMS/MVS level. CVTDFA points to DFA, which is mapped by macro IHADFA. The DFAREL field contains a two-byte release level. The previously listed DFSMS/MVS services are available only if DFAREL is equal to or greater than X'3300'. (You can also use a callable service to check the DFSMS/MVS release level. See *DFSMS/MVS Version 1 Release 2 Using Advanced Services for Data Sets* .)

Specifying devices as dynamic after a migration

During migration from MVSCP to HCD, a work IODF is created. How devices are defined in this IODF is a consideration for using dynamic capability. Also when you convert an IODF from MVS/ESA SP 4.1, the same consideration is present. An IODF in these two scenarios, defines all devices as static by default. That means that if the device has support code for dynamic capability the device is installation-static. An installation-static device cannot be changed or deleted

dynamically in the software definition. Therefore you will probably want to modify the IODF to override its installation-static default characteristics for specific devices.

The scope of modification is installation-specific, dependent on installed IBM products, other vendor products, and installation applications that are sensitive to I/O configuration changes. The scope of modification also depends on the abilities of these products and applications to support and coexist in the new environment.

Use HCD to redefine the devices. See *z/OS HCD User's Guide* for information on how to change device definitions.

All devices are also defined with below 16 megabyte UCBs after migration. When you migrate an HCD IODF to MVS/ESA SP 5.2, depending on your storage constraints, you might want to redefine some of the UCBs to be above 16 megabytes to conserve below 16 megabyte common storage. If the device support code supports above 16 megabyte UCBs, the LOCANY parameter appears on the HCD Define Device Parameters / Features panel. Change the LOCANY parameter value from "No" to "Yes" and activate the new IODF.

Testing dynamic activation

When you dynamically activate a new I/O configuration, you can choose to first run in test mode, to see if the activation will run. If the test indicates a problem, HCD displays error messages at the terminal. The test function includes the following checks:

- The IODF specified for activation exists and is a production IODF.
- The EDT specified for activation exists and is contained in the specified IODF.
- The new configuration information will fit into the current HSA.
- The device support code for all devices is present.
- The device support code for a device supports dynamic capability.
- I/O devices that you are deleting are offline.
- Paths that you are deleting are offline.
- The software activation specifies an IODF that matches the configuration definition in HSA.
- The specified IOCDS is a valid data set.
- The activation is not changing partition names or the number of partitions.
- Any new processor has at least one CHPID identified for it.
- The activation does not change a processor type or configuration mode.
- The activation does not cause a physical control unit to be added to a logical control unit if the addition causes two logical control units (with devices attached) to merge into one logical control unit.
- The activation does not cause a physical control unit to be removed from a logical control unit if the deletion causes a split of one logical control unit (with devices attached) into two logical control units.
- The operating system level is MVS/ESA SP 5.1 or later if coupling facility channel paths are being defined by the activation.
- The activation does not change a coupling facility receiver channel path.
- The activation does not cause a loss of connectivity to an active coupling facility by deleting the last operational channel path from the coupling facility control unit.

You can run with the test function before you activate using the HCD panels or ACTIVATE command. On the HCD Activate New Configuration panels, there is a TEST Only field in which you can specify YES to test the activation and NO to when you ready to perform the activation. To use the test function with the ACTIVATE command, specify the TEST keyword. Omit the TEST keyword to actually perform the activation.

There are some checks that the test function does not perform that the actual activation does:

- The test function does not check for pinned devices because devices are only unpinned for the actual delete signal. This is more efficient. It is also possible that during a test the device would not be pinned and then attention processing causes the device to be pinned during actual activate.
- The test function also does not check SQA storage requirements for changes due to activate on the test.

If you activate hardware and software in test mode, HCD can provide information about channel paths, control units, and devices that are deleted, modified, or added. In order to obtain this information, you must either:

- Set the HCD profile option SHOW_IO_CHANGES=YES in the HCD dialog, or
- Issue the ACTIVATE command using the activate action in the HCD dialog.

Recovery during dynamic configuration

If your system fails while making dynamic configuration changes to the hardware definition, you can recover the I/O configuration even if the system failure requires a re-IPL.

Notes:

1. Although these recovery procedures describe using the ACTIVATE command, you can also use an HCD panel to recover from a failure that occurs during dynamic configuration changes. When HCD recommends recovery during configuration activation, a panel displays where you can specify recovery options. You can choose to try to continue with the activation or to reset the configuration to the original (source) configuration. See *z/OS HCD User's Guide* for more information.
2. If your processor is running in logically partitioned (LPAR) mode, see "Recovering LPAR mode dynamic configuration changes" on page 4-24.

Recovering dynamic configuration changes

After a failure during a dynamic configuration change, you can either recover the configuration that was active before the failure or continue making changes from the point of failure and complete the configuration change. In the latter case, MVS must have access to both the source IODF, which defines the original I/O hardware configuration, and the target IODF, which defines the new I/O hardware configuration.

Recovering original I/O configuration without re-IPL

If the system failure does not require a re-IPL, and you want to recover the I/O configuration that was active before the failure, do the following:

- Issue the ACTIVATE command with the RECOVER keyword and SOURCE option. MVS backs out all dynamic I/O hardware changes made prior to the failure, returning the system to its original (source) I/O hardware configuration.

Continuing I/O configuration changes without re-IPL

If the failure does not require a re-IPL, and you want to continue making dynamic configuration changes from the point of failure, do the following:

- Issue the ACTIVATE command with the RECOVER keyword and TARGET option. MVS continues making the remaining dynamic configuration changes, finishing building the new (target) I/O hardware configuration. If you do not specify TARGET or SOURCE option, MVS continues in the same direction as when failure occurred.

Recovering original I/O configuration with re-IPL

If the system failure requires a re-IPL, and you want to recover the I/O configuration that was active before the failure, follow these steps:

1. Specify the source IODF in the LOADxx member of SYS1.PARMLIB or SYSn.IPLPARM. See “IODF processing at IPL” on page 3-5 for more information.
2. Re-IPL the system.
3. Issue the ACTIVATE command with the RECOVER keyword and SOURCE option. MVS backs out all dynamic hardware changes made prior to the failure, returning the system to its original (source) I/O hardware configuration.

Continuing I/O configuration changes with re-IPL

If the failure requires a re-IPL, and you want to continue making dynamic configuration changes from the point of failure, follow these steps:

1. Specify the target IODF in the LOADxx member of SYS1.PARMLIB or SYSn.IPLPARM. See “IODF processing at IPL” on page 3-5 for more information.
2. Re-IPL the system.
3. Issue the ACTIVATE command with the RECOVER keyword and TARGET option. MVS continues making the remaining dynamic changes, finishing building the new (target) I/O hardware configuration.

Recovering LPAR mode dynamic configuration changes

In LPAR mode, after a failure during a dynamic configuration change, you can recover the system to its original I/O configuration or continue making dynamic configuration changes from either the logical partition that had failed or from any other logical partition.

Recovering original LPAR mode I/O configuration without system reset

If your processor was running in LPAR mode, the failure does not require a system reset, and you want to recover the I/O configuration that was active before the failure occurred, follow these steps:

1. In all logical partitions, to make software-only changes, activate the source IODF.
2. In any logical partition, issue the ACTIVATE command with the RECOVER keyword and SOURCE option. MVS backs out all dynamic configuration changes made prior to the failure, returning the system to its original (source) I/O hardware configuration, which is shared by all logical partitions.

Continuing LPAR mode I/O configuration changes without system reset

If your processor was running in LPAR mode, the failure does not require a system reset, and you want to continue making dynamic configuration changes from the point of failure, do the following:

- In any logical partition, issue the ACTIVATE command with the RECOVER keyword and TARGET option. MVS continues making the remaining dynamic configuration changes, finishing building the new (target) I/O hardware configuration, which is shared by all logical partitions.

Recovering original LPAR mode I/O configuration with system reset

If your processor was running in LPAR mode, the failure requires a system reset, and you want to recover the I/O configuration that was active before the failure occurred, follow these steps:

1. In the logical partition that failed, specify the source IODF in the LOADxx member of SYS1.PARMLIB or SYSn.IPLPARM. See “IODF processing at IPL” on page 3-5 for more information.
2. For Enterprise System/9000, perform system reset on the logical partition that failed. (See *Enterprise System/9000 Operator Guide* for more information.)
3. In all logical partitions, make software-only changes, activating the source IODF.
4. In any logical partition, issue the ACTIVATE command with the RECOVER keyword and SOURCE option. MVS backs out all dynamic configuration changes made prior to the failure, returning the system to its original (source) I/O hardware configuration, which is shared by all logical partitions.

Continuing LPAR mode I/O configuration changes with system reset

If your processor was running in LPAR mode, the failure requires a system reset, and you want to continue making dynamic configuration changes from the point of failure, follow these steps:

1. In the logical partition that failed, specify the target IODF in the LOADxx member of SYS1.PARMLIB or SYSn.IPLPARM. See “IODF processing at IPL” on page 3-5 for more information.
2. Perform system reset on the logical partition that failed. (See *Enterprise System/9000 Operator Guide* .)
3. In any logical partition, issue the ACTIVATE command with the RECOVER keyword and TARGET option. This continues making the remaining dynamic configuration changes, finishing building the new (target) I/O hardware configuration, which is shared by all logical partitions.

Appendix A. Device support for dynamic configuration

To determine which devices on your system support dynamic I/O configuration, use the Hardware Configuration Definition (HCD) device definition panel. If the panel says the specific device can be defined as dynamic, the device supports dynamic configuration. For the most current information about device support for dynamic I/O configuration, you can also see the specific device publications.

You might need the following information about display devices and CTC connectors:

Display devices: Display devices can be dynamically added and deleted but cannot be used as multiple console support (MCS) consoles unless they have been defined in the CONSOLxx member and have a UCB at the IPL.

Channel-to-channel (CTC) connectors: CTCs can be added and deleted but cannot be removed from global resource serialization rings, unless the CTC is managed by Cross-System Coupling Facility (XCF). If XCF is managing the CTCs, your installation must stop XCF from using them before dynamically deleting the CTCs.

Appendix B. Summary of device information

For the most current information about device support, see the specific device publication or use the “Query supported hardware and installed UIMs” option on the HCD primary task selection panel. For details about printing reports using HCD and an example of the Supported Hardware report, see *z/OS HCD User's Guide*.

Appendix C. Accessibility

Accessibility features help a user who has a physical disability, such as restricted mobility or limited vision, to use software products successfully. The major accessibility features in z/OS enable users to:

- Use assistive technologies such as screen readers and screen magnifier software
- Operate specific or equivalent features using only the keyboard
- Customize display attributes such as color, contrast, and font size

Using assistive technologies

Assistive technology products, such as screen readers, function with the user interfaces found in z/OS. Consult the assistive technology documentation for specific information when using it to access z/OS interfaces.

Keyboard navigation of the user interface

Users can access z/OS user interfaces using TSO/E or ISPF. Refer to *z/OS TSO/E Primer*, *z/OS TSO/E User's Guide*, and *z/OS ISPF User's Guide Volume I* for information about accessing TSO/E and ISPF interfaces. These guides describe how to use TSO/E and ISPF, including the use of keyboard shortcuts or function keys (PF keys). Each guide includes the default settings for the PF keys and explains how to modify their functions.

z/OS Information

z/OS information is accessible using screen readers with the BookServer/Library Server versions of z/OS books in the Internet library at:

<http://www.ibm.com/servers/eserver/zseries/zos/bkserv/>

One exception is command syntax that is published in railroad track format; screen-readable copies of z/OS books with that syntax information are separately available in HTML zipfile form upon request to mhvrcfs@us.ibm.com.

Notices

This information was developed for products and services offered in the U.S.A. IBM may not offer the products, services, or features discussed in this document in other countries. Consult your local IBM representative for information on the products and services currently available in your area. Any reference to an IBM product, program, or service is not intended to state or imply that only that IBM product, program, or service may be used. Any functionally equivalent product, program, or service that does not infringe any IBM intellectual property right may be used instead. However, it is the user's responsibility to evaluate and verify the operation of any non-IBM product, program, or service.

IBM may have patents or pending patent applications covering subject matter described in this document. The furnishing of this document does not give you any license to these patents. You can send license inquiries, in writing, to:

IBM Director of Licensing
IBM Corporation
North Castle Drive
Armonk, NY 10504-1785
U.S.A.

For license inquiries regarding double-byte (DBCS) information, contact the IBM Intellectual Property Department in your country or send inquiries, in writing, to:

IBM World Trade Asia Corporation
Licensing
2-31 Roppongi 3-chome, Minato-ku
Tokyo 106, Japan

The following paragraph does not apply to the United Kingdom or any other country where such provisions are inconsistent with local law:

INTERNATIONAL BUSINESS MACHINES CORPORATION PROVIDES THIS PUBLICATION "AS IS" WITHOUT WARRANTY OF ANY KIND, EITHER EXPRESS OR IMPLIED, INCLUDING, BUT NOT LIMITED TO, THE IMPLIED WARRANTIES OF NON-INFRINGEMENT, MERCHANTABILITY OR FITNESS FOR A PARTICULAR PURPOSE. Some states do not allow disclaimer of express or implied warranties in certain transactions, therefore, this statement may not apply to you.

This information could include technical inaccuracies or typographical errors. Changes are periodically made to the information herein; these changes will be incorporated in new editions of the publication. IBM may make improvements and/or changes in the product(s) and/or the program(s) described in this publication at any time without notice.

Any references in this information to non-IBM Web sites are provided for convenience only and do not in any manner serve as an endorsement of those Web sites. The materials at those Web sites are not part of the materials for this IBM product and use of those Web sites is at your own risk.

IBM may use or distribute any of the information you supply in any way it believes appropriate without incurring any obligation to you.

Licensees of this program who wish to have information about it for the purpose of enabling: (i) the exchange of information between independently created programs

and other programs (including this one) and (ii) the mutual use of the information which has been exchanged, should contact:

IBM Corporation
Mail Station P300
2455 South Road
Poughkeepsie, NY 12601-5400
U.S.A

Such information may be available, subject to appropriate terms and conditions, including in some cases, payment of a fee.

The licensed program described in this information and all licensed material available for it are provided by IBM under terms of the IBM Customer Agreement, IBM International Program License Agreement, or any equivalent agreement between us.

This information contains examples of data and reports used in daily business operations. To illustrate them as completely as possible, the examples include the names of individuals, companies, brands, and products. All of these names are fictitious and any similarity to the names and addresses used by an actual business enterprise is entirely coincidental.

COPYRIGHT LICENSE:

This information contains sample application programs in source language, which illustrates programming techniques on various operating platforms. You may copy, modify, and distribute these sample programs in any form without payment to IBM, for the purposes of developing, using, marketing or distributing application programs conforming to the application programming interface for the operating platform for which the sample programs are written. These examples have not been thoroughly tested under all conditions. IBM, therefore, cannot guarantee or imply reliability, serviceability, or function of these programs. You may copy, modify, and distribute these sample programs in any form without payment to IBM for the purposes of developing, using, marketing, or distributing application programs conforming to IBM's application programming interfaces.

If you are viewing this information softcopy, the photographs and color illustrations may not appear.

Trademarks

The following terms are trademarks of the IBM Corporation in the United States or other countries or both:

- CICS
- DFSMS/MVS
- Enterprise Storage Server
- Enterprise System/9000
- ES/3090
- ES/9000
- ESCON
- @server
- FICON
- IBM
- IBMLink
- Multiprise
- MVS

- MVS/ESA
- OS/390
- PR/SM
- PS/2
- RACF
- Resource Link
- RMF
- S/390
- S/390 Parallel Enterprise Server
- VTAM
- zSeries
- z/OS
- z/OS.e

Other company, product, and service names may be trademarks or service marks of others.

Index

A

- above 16 megabyte UCB
 - description 2-35
 - specifying after migration 4-22
- accessibility C-1
- ACTIVATE command
 - activate new configuration 4-8
- activate new configuration
 - ACTIVATE command 4-8
 - dynamic configuration 4-8
 - HCD panel 4-8
 - testing 4-22
- alias devices 2-29
- alias UCB 2-29
- allocation
 - changing device order 2-46
 - defining 2-45
 - device preference table 2-41
 - EDT 2-45
 - esoteric device group 2-40
 - I/O device 2-39
 - VIO 2-47
- automatically switchable tape devices
 - benefits of 2-16
 - change the AUTOSWITCH attribute 2-34
 - define 2-17
 - definition 2-16
 - plan to use 2-17
- AUTOSWITCH device parameter 2-35

B

- base devices 2-29

C

- captured UCB 2-35
- CF (coupling facility) peer channel path
 - reconfiguring 2-14
- CF (coupling facility) receiver channel path
 - description 2-10
 - reconfiguring 2-13
 - restrictions 2-13
- CF (coupling facility) sender channel path
 - description 2-10
- CF sender (coupling facility sender) channel path
 - changing dynamically 4-13
 - deleting dynamically 4-13
- CF sender channel path
 - adding dynamically 4-12
- channel measurement block 3-4
- channel path 2-25
 - access list 2-19
 - adding dynamically 4-12
 - candidate list 2-19
 - changing dynamically 4-13
 - controlling logical partition access 2-19

- channel path (*continued*)
 - definition planning 2-6
 - deleting dynamically 4-12
 - dynamic I/O characteristic field 4-10
 - numbering 2-3
 - operation mode 2-6
- Channel path definitions 2-25
- channel paths, dynamic management 2-22
- channel subsystem
 - definition planning 2-5
- CHPID (channel path identifier)
 - description 2-3
- CMB
 - parameter 3-4
 - requirement for devices 3-4
- configuration 3-1
- configure I/O dynamically 1-1
- CONFIGxx member
 - updating after dynamic change 4-2
- console
 - device
 - dynamic 4-11
 - MCS 4-11
 - multiple console support 4-11
 - NIP 2-8
 - system 2-8
- control unit 2-7
 - adding dynamically 4-15
 - changing dynamically 4-15
 - deleting dynamically 4-15
 - description 2-11
 - dynamic I/O characteristic field 4-10
 - MIF requirement
 - logical path 2-19
 - shared channel path 2-19
- coupling facility
 - channel paths 2-10
 - description 2-10
 - peer channel paths 2-10
 - specifying logical partition 2-10
- coupling facility control unit 2-11
 - definition changed 4-16
 - definition created 4-17
 - definition deleted 4-18
- coupling facility device 2-11
 - definition created 4-17
 - definition deleted 4-17

D

- DASD (direct access storage device)
 - additional actions for dynamic change 4-9, 4-10
- data set
 - VIO 2-47
- DDR swap
 - planning 4-11
- dedicated tape device
 - definition 2-16

- device 2-7
 - adding dynamically 4-8
 - allocation
 - requesting 2-39
 - changing dynamically 4-10
 - class 2-40
 - controlling logical partition access 2-20
 - defining device features to operating system 2-32
 - deleting dynamically 4-9
 - description 2-11
 - dynamic 2-32
 - dynamic I/O characteristic field 4-10
 - generic name 2-39
 - installation requirement 4-1, 4-8
 - installation-static 2-32
 - multiple exposure 2-29
 - parallel access volume 2-29
 - static 2-32
- device class 2-40
- device number
 - description 2-28
 - replicating 2-29
- device preference table
 - affect on unit affinity 2-43
 - defining change 2-46
 - description 2-41
 - values B-1
- device support code
 - loading at IPL 3-7, 4-8
- device type
 - unsupported 2-32
- disability C-1
- documents, licensed ix
- dynamic alias management 2-31
- dynamic channel path management 2-22
- dynamic configuration
 - changing characteristic field 4-10, 4-14, 4-15
 - characteristic field
 - channel path 4-14
 - control unit 4-15
 - I/O device 4-10
 - considerations for MVS installed products 4-12
 - creating new IOCDS 3-10, 4-2
 - description 1-1
 - HSA consideration 3-3
 - LPAR mode change 4-2
 - migrating 4-18
 - performing 4-1
 - planning 2-32
- dynamic device
 - adding 2-32
 - deleting 2-32
 - description 2-32
 - modifying 2-32
 - redefining to installation-static 2-34
 - specifying after migration 4-22
- dynamic I/O configuration 1-1
- dynamic reconfiguration 1-1
- dynamic reconfiguration management 1-1
- dynamically activating 2-25

E

- EDT (eligible device table) 2-45
 - defining multiple 2-46
 - description 1-4
 - dynamic configuration 2-47
 - primary 2-47
 - processing at IPL 3-7
 - secondary 2-47
- ESCON channel path
 - logical address
 - specifying through HCD 2-21
 - processor complex communication 2-21
 - shared 2-21
- ESCON CTC control unit
 - logical address
 - specifying through HCD 2-21
- ESCON requirement
 - MIF 2-19
 - shared channel path 2-19
- ESCON switches 2-4
- esoteric device group
 - advantage 2-42
 - defining 2-40
 - naming 2-46
 - required
 - SYSDA 2-41
 - SYSSQ 2-41
 - specifying order 2-41

F

- Fibre Channel switches 2-4
- FICON 2-25
- FICON channels
 - migration 2-25
 - CNC to FCV channel paths 2-25
 - from CNC or FCV to FC channel paths on the control unit 2-27
- FICON Channels 2-25

G

- generic device type
 - for allocation 2-39
 - list B-1
 - making VIO eligible 2-47
 - viewing in HCD 2-47
- guest operating system
 - dynamic configuration 1-9
 - MVS under VM 1-9

H

- hardware and software configuration
 - change 1-8, 4-8
 - matching 1-6, 4-1
- hardware configuration definition 3-1
- Hardware Configuration Manager 1-10
- hardware prerequisite 4-18
- hardware system area 3-3

- HCD (hardware configuration definition)
 - description 1-2
 - invoking 3-2
- HCD capability
 - MVS/ESA and MIF 2-18
 - spanned channel paths 2-24
- HCD panel
 - activate new configuration 4-8
 - define configuration 2-3
 - recovery options 4-23
- HCM 1-10
- HSA (hardware system area)
 - description 1-6
 - expansion requirement 3-3

I

- I/O component
 - changing definition 4-8
- I/O configuration 3-1
 - defining initially 3-1
 - dynamic change 4-1
 - hardware and software match 1-6, 4-1
 - planning decision 2-1
- I/O configuration data set 3-3
- I/O control unit
 - definition planning 2-7
- I/O definition file 3-5
- I/O device
 - definition planning 2-7
- ICMF (Integrated Coupling Migration Facility)
 - configuration considerations 2-12
- initial program load 3-5
- initialization 2-8
 - console
 - NIP 2-8
 - NIP 2-8
 - NIP console 2-8
 - system console 2-8
- installation-static device 4-24
 - adding 2-32
 - deleting 2-32
 - description 2-32
 - migration consideration 4-19
 - modifying 2-32
 - redefining to dynamic 2-34
- intelligent resource director 2-22
- IOCDS (I/O configuration data set) 2-14
 - creating new 3-3, 3-10, 4-2
 - description 1-6
- IOCP (I/O configuration program)
 - description 1-5
- IODF 2-25
- IODF (I/O definition file)
 - name 3-6
 - processing
 - IPL 3-5
- IPL (initial program load)
 - IODF processing 3-5
 - parameters
 - managing from a single point of control 2-14

J

- JES3 initialization stream checker
 - providing configuration data 2-9

K

- keyboard C-1

L

- LCU (logical control unit)
 - description 2-2
- licensed documents ix
- LOADxx member
 - SYSn.IPLPARM 3-5
- LOCANY device parameter 2-39
- logical address
 - ESCON CTC control unit 2-21
 - specifying through HCD 2-21
- logical control unit 2-2
- logically partitioned mode 2-2
- LookAt message retrieval tool ix
- LPAR (logically partitioned) mode
 - access to channel path 2-19
 - access to device 2-20
 - activating change 4-2
 - continue I/O configuration change
 - without system reset 4-24
 - description 2-2
 - dynamic configuration
 - activating change 4-2
 - recovery 4-24
 - recover original I/O configuration
 - with system reset 4-25
 - without system reset 4-24
 - recovery 4-24

M

- MCS (multiple console support)
 - console 4-11
- message retrieval tool, LookAt ix
- MIF (Multiple Image Facility) capability
 - comparison
 - shared channel path 2-18
 - unshared channel path 2-18
 - shared channel path requirement
 - control unit logical path 2-19
 - ESCON 2-19
- migration
 - dynamic configuration 4-18
- Migration
 - HCD 2-25
- multiple console support 4-11
- multiple exposure device 2-29
- MVS/ESA capability
 - HCD and MIF 2-18
 - spanned channel paths 2-24

N

NIP (nucleus initialization program)
 console 2-8
Notices D-1
nucleus initialization program 2-8

O

operating system
 configuration identifier
 processing at IPL 3-8
 definition planning 2-4

P

parallel access volume 2-29
PR/SM (Processor Resource/System Manager)
 LPAR mode
 dynamic configuration 2-2
processor
 allow dynamic modification option 3-3
 definition planning 2-5
 percent expansion option 3-3
processor configuration token
 description 1-6
Processor Resource / System Manager 2-2
production IODF
 description 1-3
 name 3-6

R

RACF protection
 ACTIVATE command 3-1
 HCD panel 3-1
reconfigure I/O dynamically 1-1
recover original I/O configuration
 LPAR mode
 with system reset 4-25
 without system reset 4-24
recovery
 configuration change 4-23, 4-24
 continue I/O configuration change
 with re-IPL 4-24
 without re-IPL 4-24
 dynamic configuration change 4-23
 procedure 4-23
 with re-IPL 4-24
 without re-IPL 4-23, 4-24
 procedure
 dynamic configuration 4-23
 recover original I/O configuration
 with re-IPL 4-24
 without re-IPL 4-23, 4-24
replication factor
 device number 2-29
restrictions 2-25

S

S/390 9672 Parallel Transaction Server
 identifying IODF volume 3-5
 managing IOCDs and updating IPL
 parameters 2-14
S/390 9674 Coupling Facility
 managing IOCDs and updating IPL
 parameters 2-14
shared channel path
 compared with unshared 2-18
 logical partition access 2-19
 requirement
 control unit logical path 2-19
 critical I/O device 2-19
 ESCON 2-19
shortcut keys C-1
software only
 change 1-9, 4-8
SQA
 parameter 3-3
 requirement for UCBs 3-3
static device
 description 2-32
storage management with above 16 megabyte
 UCBs 2-35
switch
 definition 2-4
SYS1.PARMLIB
 LOADxx member 3-5
SYSDA
 esoteric device group
 required 2-41
SYSn.IPLPARM
 LOADxx member 3-5
SYSSQ
 esoteric device group
 required 2-41
system environment
 dynamic configuration
 DDR swap 4-11
 device 4-11
 planning 4-11

T

tape device
 assigning in a sysplex 2-17
 define automatically switchable 2-34
 in a sysplex 2-16
testing
 activation 4-22
token
 checking software and hardware configuration
 match 1-6

U

UCB (unit control block)
 alias 2-29
 defining above 16 megabytes 2-35

- UCB (unit control block) *(continued)*
 - description 1-4
 - dynamic configuration
 - storage requirement 3-3
 - SQA requirement 3-3
- UCB service
 - general method 4-19
 - limited method 4-19
- UIM (unit information module)
 - description 1-4
 - loading at IPL 3-7, 4-8
- unsupported
 - device 2-32

V

- validated work IODF
 - description 1-3
- vary
 - tape device as automatically switchable 2-34
- VIO (virtual I/O) data set
 - advantage 2-47
 - generic device type
 - making eligible 2-47
- volume
 - parallel access 2-29

W

- work IODF
 - description 1-3

Z

- z990
 - considerations 2-8
 - spanned channel paths 2-24
- zSeries 900 1-5
 - storage of an IOCDs 1-6

Readers' Comments — We'd Like to Hear from You

**z/OS
Hardware Configuration Definition
Planning**

Publication No. GA22-7525-06

Overall, how satisfied are you with the information in this book?

	Very Satisfied	Satisfied	Neutral	Dissatisfied	Very Dissatisfied
Overall satisfaction	<input type="checkbox"/>	<input type="checkbox"/>	<input type="checkbox"/>	<input type="checkbox"/>	<input type="checkbox"/>

How satisfied are you that the information in this book is:

	Very Satisfied	Satisfied	Neutral	Dissatisfied	Very Dissatisfied
Accurate	<input type="checkbox"/>	<input type="checkbox"/>	<input type="checkbox"/>	<input type="checkbox"/>	<input type="checkbox"/>
Complete	<input type="checkbox"/>	<input type="checkbox"/>	<input type="checkbox"/>	<input type="checkbox"/>	<input type="checkbox"/>
Easy to find	<input type="checkbox"/>	<input type="checkbox"/>	<input type="checkbox"/>	<input type="checkbox"/>	<input type="checkbox"/>
Easy to understand	<input type="checkbox"/>	<input type="checkbox"/>	<input type="checkbox"/>	<input type="checkbox"/>	<input type="checkbox"/>
Well organized	<input type="checkbox"/>	<input type="checkbox"/>	<input type="checkbox"/>	<input type="checkbox"/>	<input type="checkbox"/>
Applicable to your tasks	<input type="checkbox"/>	<input type="checkbox"/>	<input type="checkbox"/>	<input type="checkbox"/>	<input type="checkbox"/>

Please tell us how we can improve this book:

Thank you for your responses. May we contact you? Yes No

When you send comments to IBM, you grant IBM a nonexclusive right to use or distribute your comments in any way it believes appropriate without incurring any obligation to you.

Name

Address

Company or Organization

Phone No.



Fold and Tape

Please do not staple

Fold and Tape



NO POSTAGE
NECESSARY
IF MAILED IN THE
UNITED STATES

BUSINESS REPLY MAIL

FIRST-CLASS MAIL PERMIT NO. 40 ARMONK, NEW YORK

POSTAGE WILL BE PAID BY ADDRESSEE

IBM Corporation
Department 55JA, Mail Station P384
2455 South Road
Poughkeepsie, NY
12601-5400

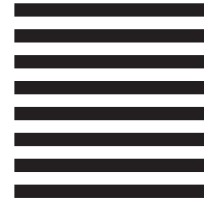

Fold and Tape

Please do not staple

Fold and Tape



Program Number: 5694-A01,5655-G52

Printed in USA

GA22-7525-06

